



**CONTROL  
TECHNIQUES**

# COMPREHENSIVE CATALOGUE

**DRIVE OBSESSED**



# WELCOME

**Control Techniques, a Nidec company, is the global drives specialist with a long entrepreneurial history.**

More recently, we have the support of a large international parent company, Nidec, and its other brands. We are a challenger with a big name in the drives industry. We pride ourselves on the service we provide, not only from Newtown in Wales, but also from our network of 45 drive centres around the world. We are drive obsessed, and our ambition pushes us to be the go-to for drives.

In this catalogue you'll learn about the tools we create that help innovators to move the world. From our general purpose Commander range, up to our high performance Unidrive family; whatever your application we have the answer.

We've been doing this for decades and have a long history of firsts.

**So, whenever you think drives, think Control Techniques.**

**Anthony Pickering**

President, Control Techniques



## WELCOME

3

Contents	4
Class-Leading Motor Control Products	6
Control Techniques	8
Nidec Corporation	9
Grew. Innovated. Advanced	10
Our Purpose	12
Our Vision	13
Our Priorities	14
Our Promise	15
A History of Drive Innovation	16
Inspired Machines. Trusted Partners.	18
Nidec Synergy Portfolio	20
One Nidec	22

## CUSTOMERS

24

OEMs	24
Distributors	26
End Users	28

## COMPANY SUPPORT

30

Local Support, Global Reach	32
World Class Performance	34
Technology you can rely on	34
Embedded Intelligence	35
Open Design Architecture	35
Reliability Process Control	36
Social Responsibility	36
Website	37

## TOP SOLUTIONS

38

Cranes & Hoists	39
Fans & Pumps	40
Food & Drink	41
Material Handling	42
Packaging	43
Plastics & Rubber	44
Stage & Theatre	45

## PRODUCTS

46

### GENERAL PURPOSE DRIVES

48

Commander C	49
-------------	----

### HIGH PERFORMANCE DRIVES

60

Unidrive M700, M701 & M700	62
Unidrive M600	72
Unidrive M Series	82
Unidrive M400	88
Extreme Power	96

### FREESTANDING DRIVES

98

DFS Series	99
------------	----

### SPECIALISTS DRIVES

108

Elevator Drive E300	110
Pump Drive F600	120

<b>SERVO DRIVES AND MOTORS</b>	<b>130</b>	<b>SERVICE &amp; SUPPORT</b>	<b>226</b>
Digitax HD	132	Technical Support	228
Digitax SF	140	Drive Set-up	229
Unimotor hd	152	Diagnostic Tool	230
		5 Year Warranty	231
<b>DC DRIVES</b>	<b>170</b>	Documentation	232
Mentor MP	171	Services & Repairs	234
		Drive Systems	235
<b>INDUSTRIAL CONTROL</b>	<b>178</b>	Training	236
PLC Controlled Motion	180	Virtual Demo	237
HMI Panels and Software	182	Drive Centres	238
Ethercat Remote I/Os	186		
RTME or Modbus TCP Remote I/Os	188	<b>FAQs</b>	<b>240</b>
PTI210 Powertools	190	General	241
Applications	192	Commander C	242
MCi200 & MCi210	194	Unidrive M700	245
Option Modules	196	Digitax HD	248
		Mentor MP	249
<b>PC TOOLS</b>	<b>198</b>	PTi210	254
		Software Tools	258
<b>ACCESSORIES</b>	<b>200</b>	Other Topics	259
<b>CERTIFICATIONS</b>	<b>222</b>	<b>DISCOVER MORE</b>	<b>260</b>
		Big Books	261
<b>STANDARDS</b>	<b>224</b>	Green Books	261

# DRIVING THE WORLD WITH **CLASS-LEADING MOTOR CONTROL PRODUCTS**

Control Techniques is 100% focused on delivering world-class variable speed drives and power conversion technologies that are used in industry, commerce and renewable energy schemes.

Our motor control solutions help businesses to significantly reduce energy costs and improve their operating efficiency.



## General Purpose Drives

### Commander

- C300
- C200

## High Performance Drives

### Unidrive

- M700
- M600
- M400
- Extreme Power

## Freestanding Drives

### DFS Series

- DFS Series

## Specialist Drives

- Elevator Drive E300
- Pump Drive F600



## Servo Drives & Motors

### Digitax

Digitax HD Series  
Digitax SF  
Unimotor hd



## DC Drives

### Mentor

Mentor MP



## Industrial Control

PLC Controlled Motion  
MCH040, MCH070, MCHMobile  
Remote I/O and EtherCAT I/O  
Integration Modules

# DRIVE OBSESSED



**Control Techniques has been designing and manufacturing the best variable speed drives in the world since 1973.**

**Our customers reward our commitment to building drives that outperform the market. They trust us to deliver on time every time with our trademark outstanding service.**

More than 45 years later, we're still in pursuit of the best motor control, reliability and energy efficiency you can build into a drive. That's what we promise to deliver, today and always.

**1.4K+**

**Employees**

**70**

**Countries**



# #1 FOR ADVANCED MOTOR AND DRIVE TECHNOLOGY



**Nidec Corporation is a global manufacturer of electric motors and drives.**

Nidec was set up in 1973. The company made small precision AC motors and had four employees. Today, it's a global corporation that develops, builds and installs cutting-edge drives, motors and control systems in over 70 countries with a workforce of more than 110,000.

You'll find its innovations in thousands of industrial plants, IoT products, home appliances, cars, robotics, mobile phones, haptic devices, medical apparatus and IT equipment all over the world.

**109K**

**Employees**

**\$14.6B**

**Group Turnover**

**70+**

**Countries**

**330+**

**Companies**

# REW. VATED. NO VATED. ADVANCED.

# HOW WE DEVELOPED A LOT HAS CHANGED IN 45 YEARS...



GROWTH



INVESTMENT



INNOVATION



# OUR PURPOSE

**Our purpose gives us a reason to exist beyond making a profit. It gets us up in the morning and draws others to work with us.**

**We are innovators. Our customers are innovators. We want to give them the tools to move the world.**

We are proud for our products and people to be the unsung heroes behind our customers who make machines that turn the world.

**EMPOWERING  
INNOVATORS TO  
MOVE THE WORLD,  
ONE REVOLUTION  
AT A TIME**

# OUR VISION

**Our vision turns our purpose into a measurable and visual goal we can work towards.**

**We are drive obsessed and our ambition pushes us to be the go-to for drives in our industry.**

It won't be easy, and all of us have a role to play in moving the world!

**WHEN ANYONE  
THINKS DRIVES,  
THEY THINK  
CONTROL  
TECHNIQUES**

# OUR PRIORITIES

**We have our priorities right.**

**While day-to-day tasks may change, the overall principles that guide us remain the same.**

The best people, continuously seeking excellence commercially and operationally, relentlessly improving the ways in which we achieve success.

**It's the Control Techniques way.**

**ENGAGE AND  
DEVELOP  
THE BEST PEOPLE.**

**BE COMMERCIALY  
AND OPERATIONALLY  
EXCELLENT.**

**CONTINUALLY  
IMPROVE  
OUR PROCESSES.  
EVERYWHERE.  
ALL THE TIME.**

# OUR PROMISE

This is our promise to our customers, it is the benefit we bring to them.

**DRIVES FOR  
EVERY PURPOSE.  
DRIVEN BY YOU,  
SUPPORTED  
BY EXPERTS**

# A HISTORY OF DRIVE INNOVATION

Founded

Mentor II

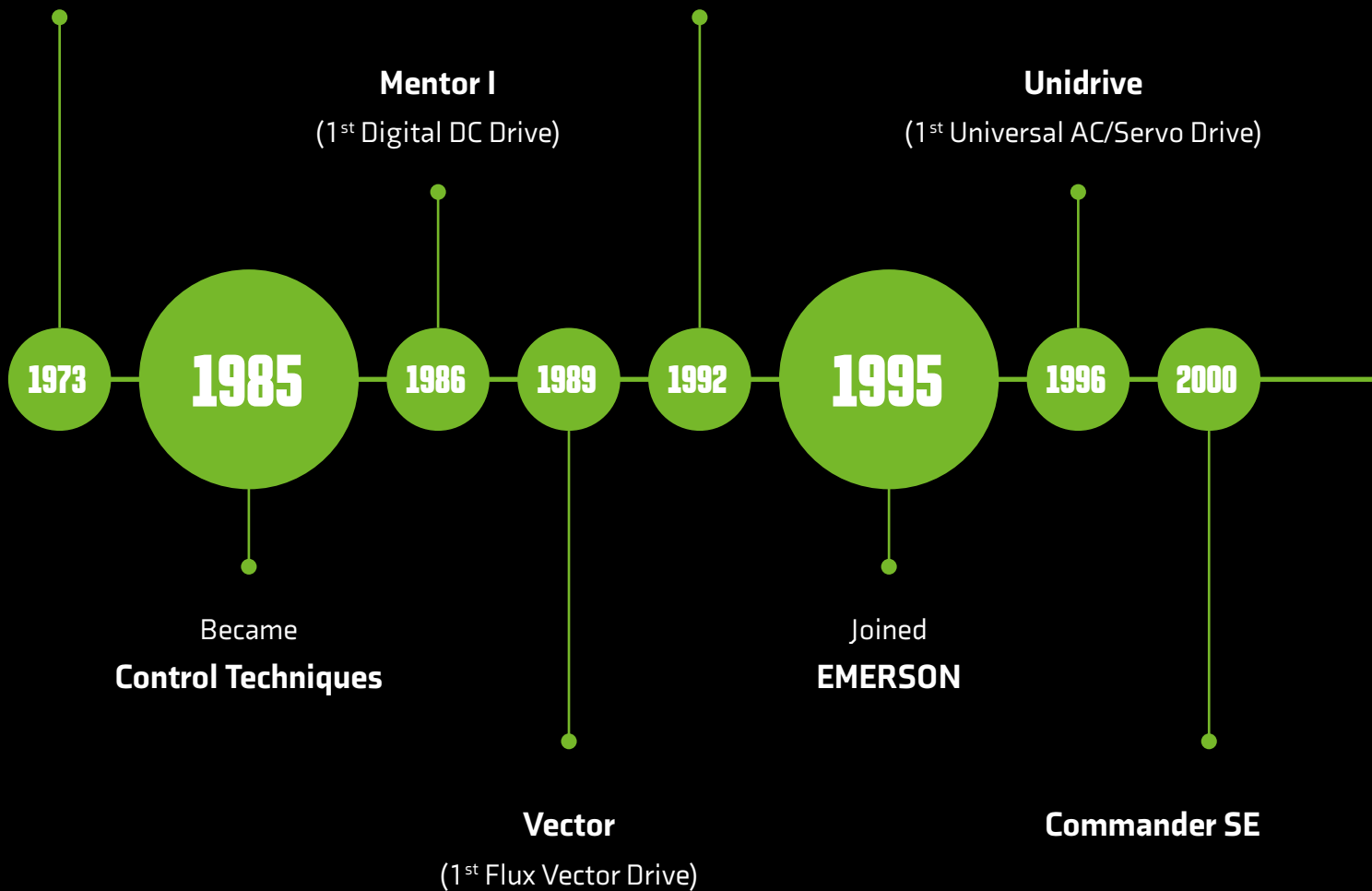



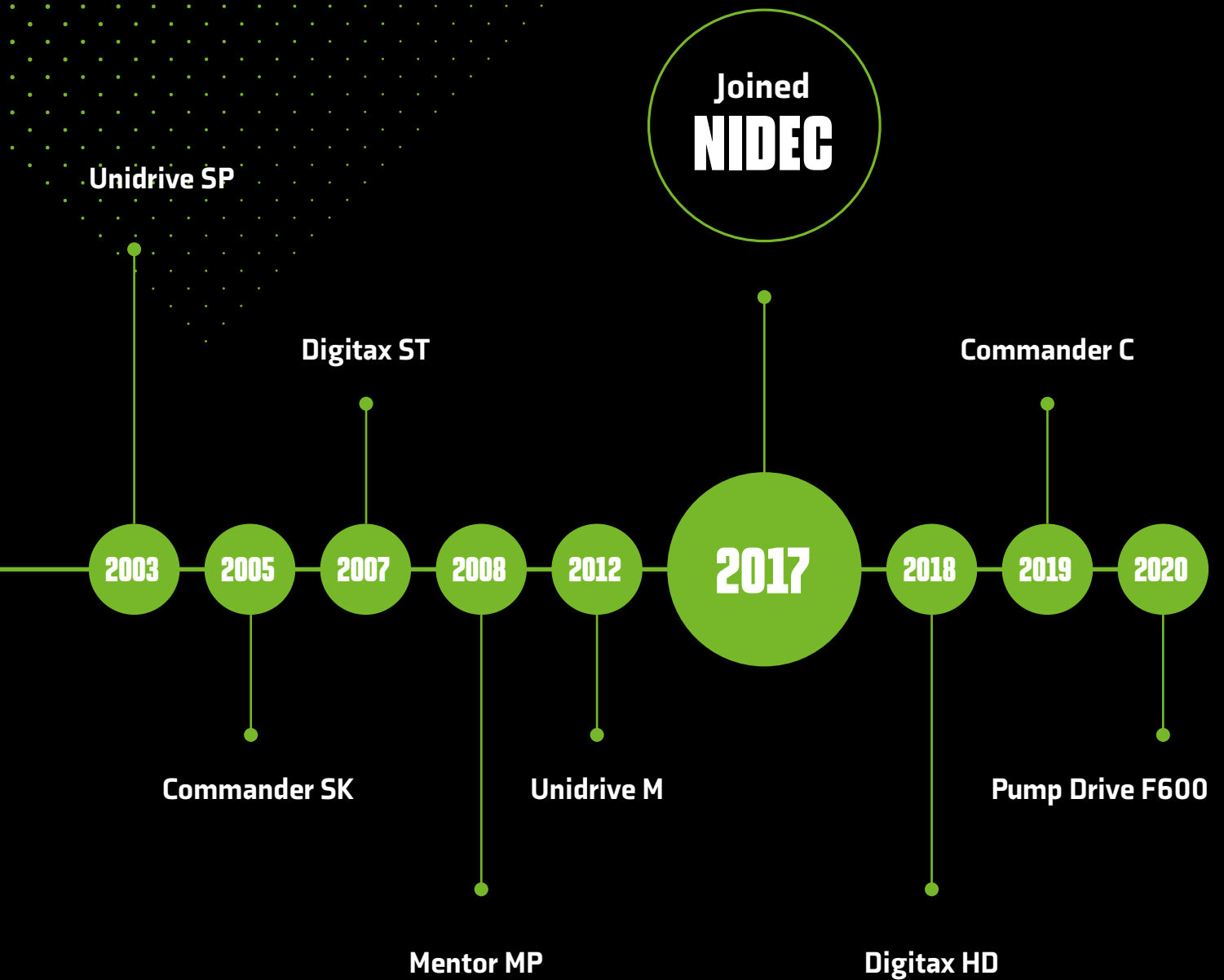

# INSPIRED MACHINES. TRUSTED PARTNERS.

**Control Techniques has been at the front of customer-focused drive technology for over 45 years. We're dedicated to the advancement of automation and providing an A-one reputation for customer service and support.**

Developing partnerships with our customer base is what we are all about. From OEM's to end-users we have drive obsessives just waiting to connect, to see your projects through from conception to completion, providing solutions that you won't find anywhere else. With our wealth of knowledge and expertise we are best placed to create a journey that is hassle free, quick and above all a partnership where we put you first.



# AND THAT'S NOT ALL PLUS ALL OF THIS

In addition to the Control Techniques product range you will also have access to our Nidec Synergy portfolio

**CTD**



Over several decades, CTD has developed generations of high performance motor ranges to meet the design, the performance, the functionality and the cost specifications of a wide range of applications and industries.

[www.controltechniquesdynamics.com](http://www.controltechniquesdynamics.com)



Bevel gears create powerful systems using housings, shafts, flanges and bearings. Your complex design is in good hands with Nidec Graessner - we've been working on intelligent concepts for over 65 years.

[www.graessner.de](http://www.graessner.de)

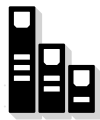

KB Electronics manufacturers off the shelf and custom OEM AC Drives Inverters, DC Drives, Fan Speed Controls - motor drives from fractional to 30 HP.

[www.nidec.com/kbelectronics](http://www.nidec.com/kbelectronics)

**Nidec**  
KATO ENGINEERING™



Kato Engineering provides reliable, durable products for your specific power generation needs, along with expertise, product support, genuine parts, remanufacturing options, and training you can depend on.

[www.kato-engineering.com](http://www.kato-engineering.com)

**LERROY  
SOMER**

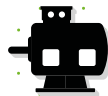

Leroy Somer design, develop and manufacture scalable, customised product & service solutions for OEMs supported by a global presence with operations and engineering & development teams in Europe, China, India & Americas.

[www.leroy-somer.com](http://www.leroy-somer.com)

**Nidec  
DRIVE SYSTEMS**

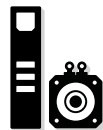

Nidec Drive Systems (NDS) is a global manufacturing enterprise that provides custom engineered control, motor and drive system solutions for world class customers in electric vehicle, commercial floor care, material handling, aerial work platforms, water pumping, and renewable energy.

[www.nidec.com](http://www.nidec.com)

**Nidec  
MOTION CONTROL**



The Nidec Motion Control product line features a full line of high efficiency motors, large and small, which serve industrial, residential, and commercial markets.

[www.nidec.com](http://www.nidec.com)

**Roboteq**



Welcome to the world's most innovative, complete and integrated Motion Control, Navigation Sensors and Power Management solutions for mobile robots.

[www.roboteq.com](http://www.roboteq.com)

**Sankyo**  
All for dreams

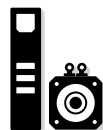

NIDEC SANKYO's portfolio includes micro motors, stepping motors, as well as card readers, industrial robots and a broad array of other equipment.

[www.nidec.com](http://www.nidec.com)















**SHIMPO**  
All for dreams



Providing high precision motion control speed reducers, Automatic Guided Vehicles (AGV's), power transmission equipment, press machines and measuring instruments.

[www.nidec.com](http://www.nidec.com)

# THE WINNING MENTALITY OF ONE NIDEC

		LOW VOLTAGE AC		
Type of Product		General Purpose	High Performance	Freestanding
Standard Software <b>CONTROL TECHNIQUES</b>				
PLC / Controller <b>CONTROL TECHNIQUES</b>			 PLC Controlled Motion	
Accessories / Connection <b>CONTROL TECHNIQUES</b>				
Drives <b>CONTROL TECHNIQUES</b> <b>Nidec</b> DRIVE SYSTEMS <b>KB</b> <b>Sankyo</b> -All for dreams <b>RoboteQ</b>		 KB	 Commander	 Unidrive
Motors <b>CTD</b> <b>LEROY SOMER</b> <b>Nidec</b> MOTION CONTROL		 Dyneo	 IMfinity	 Unimotor FM
Gears <b>SHIMPO</b> -All for dreams <b>GIRARD</b> TRANSMISSIONS				 Dynabox

# Nidec

All for dreams

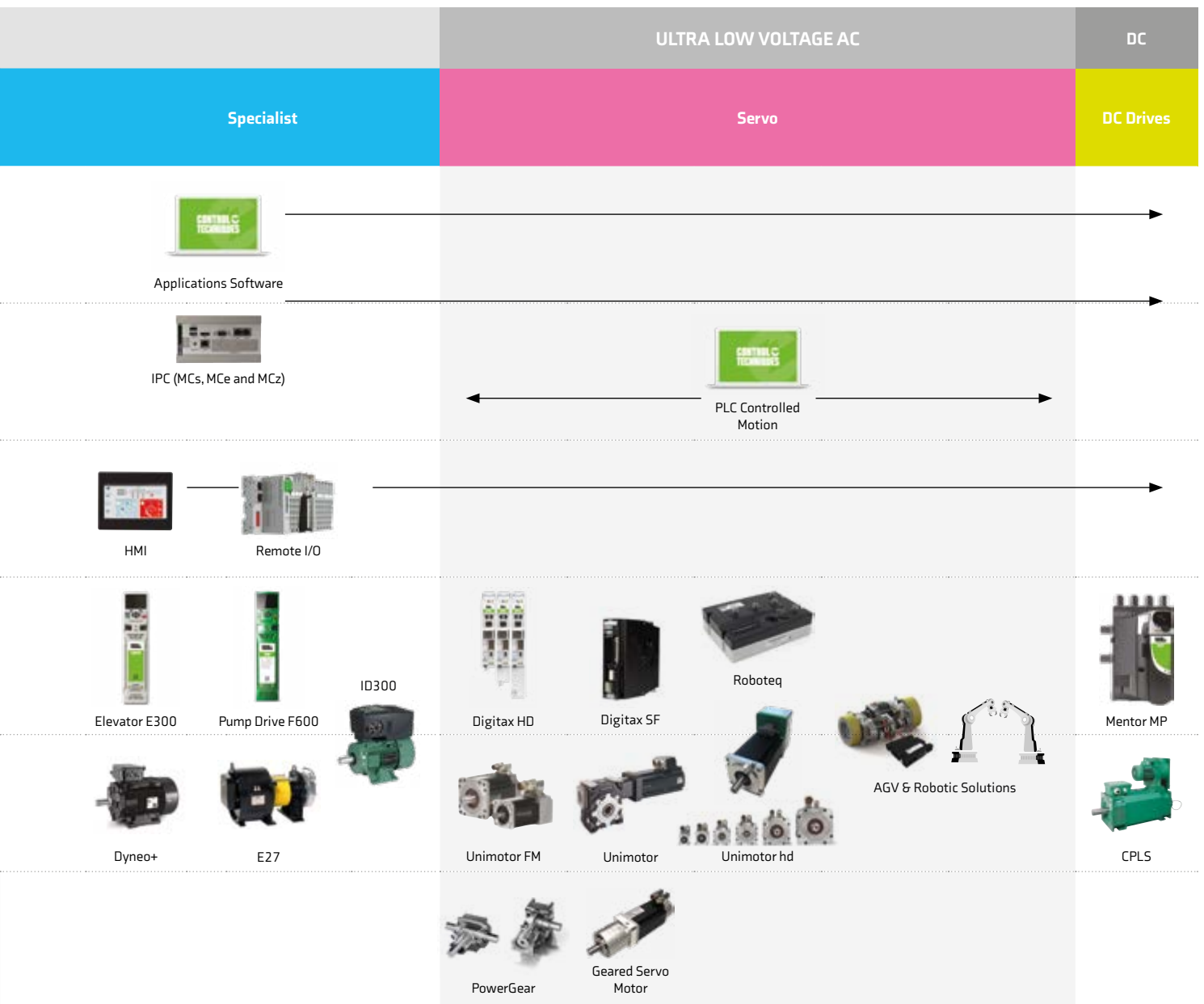

# OEMS



# SMARTER RELATIONSHIPS STAY THE COURSE

**Control Techniques understand the tough challenges faced by Original Equipment Manufacturers (OEMs) and we will make it our priority and mission to take on those challenges and turn them into opportunities for you to excel and stand out from the crowd.**

**As an organisation we offer:**

- A deep focus on and knowledge of the key sectors in both process and discrete manufacturing industries
- An excellent global infrastructure which provides:
  - i. Global manufacturing and R&D footprint
  - ii. Local technical and sales support through our global Drive Centres, Distributors and Country Partners networks
- Highly flexible and comprehensive product ranges, with options and opportunities for customisation
- Technical & engineering expertise worldwide
- Well-formed, resourced and proven new product development processes

With dedicated OEM account managers, supported by our entire organisation, we can help you develop product and service solutions that add value to your business. This includes enhancing profitability, streamlining your processes & supporting you to meet and exceed your commercial goals.

# DISTRIBUTORS



# YOUR SUCCESS IS OUR SUCCESS

**We are committed to providing everything you need to succeed in your market including:**

- World Class-Leading Products
- Commercial support to gain market share
- Technical support and customer service tailored to your local needs
- Sales Tools & Training
- Investments in marketing, promotion & campaigns
- Our aim is to create prosperous and long-term partnerships with a focus on:
  - i. Consistency & transparency
  - ii. Working relationship based on trust & respect

# END USERS

# LOCAL STOCK, GLOBAL SUPPORT

Combine our global network of Drive Centres with an extensive collection of trusted distributors, systems integrators and partners, and you get the full Control Techniques experience.

Drives available quickly, when you need them most, with support to ensure you're up and running in no time.

- Extensive local stocks via our global Drive Centres means product can be with you quicker than you think
- Expert local support and services available from drive obsessives in your region
- Flexible products which fit into any existing system thanks to our unique Open Architecture philosophy
- Comprehensive free warranty programme on selected products

# COMPANY SUPPORT

# HERE'S WHAT MAKES US DIFFERENT



### World-Class Performance

The outstanding performance of our drives is the fruit of over 45 years of engineering experience in drive design.



### Embedded Intelligence

Precision motor control is combined with the highest embedded intelligence, ensuring maximum productivity and efficiency of your machinery.



### Technology you can rely on

Robust design and the highest build quality ensure the enduring reliability of millions of our drives installed around the world.



### Open Design Architecture

Based on open design architecture, our drives integrate with all primary communication protocols.



### Reliability Process Control

Robust design and the highest build quality ensure the enduring reliability of millions of our drives installed around the world.



### Social Responsibility

Robust design and the highest build quality ensure the enduring reliability of millions of our drives installed around the world.



### Local Support, Global Reach

Highly experienced, locally based application engineers design and support drive technology to provide maximum value, wherever you are in the world.



### Website

You can find a variety of content on our website from product information and videos to latest news and downloads.

[www.controltechniques.com](http://www.controltechniques.com)  
[www.driveobsessed.com](http://www.driveobsessed.com)

# LOCAL SUPPORT, GLOBAL REACH



Discover all of our  
worldwide locations here



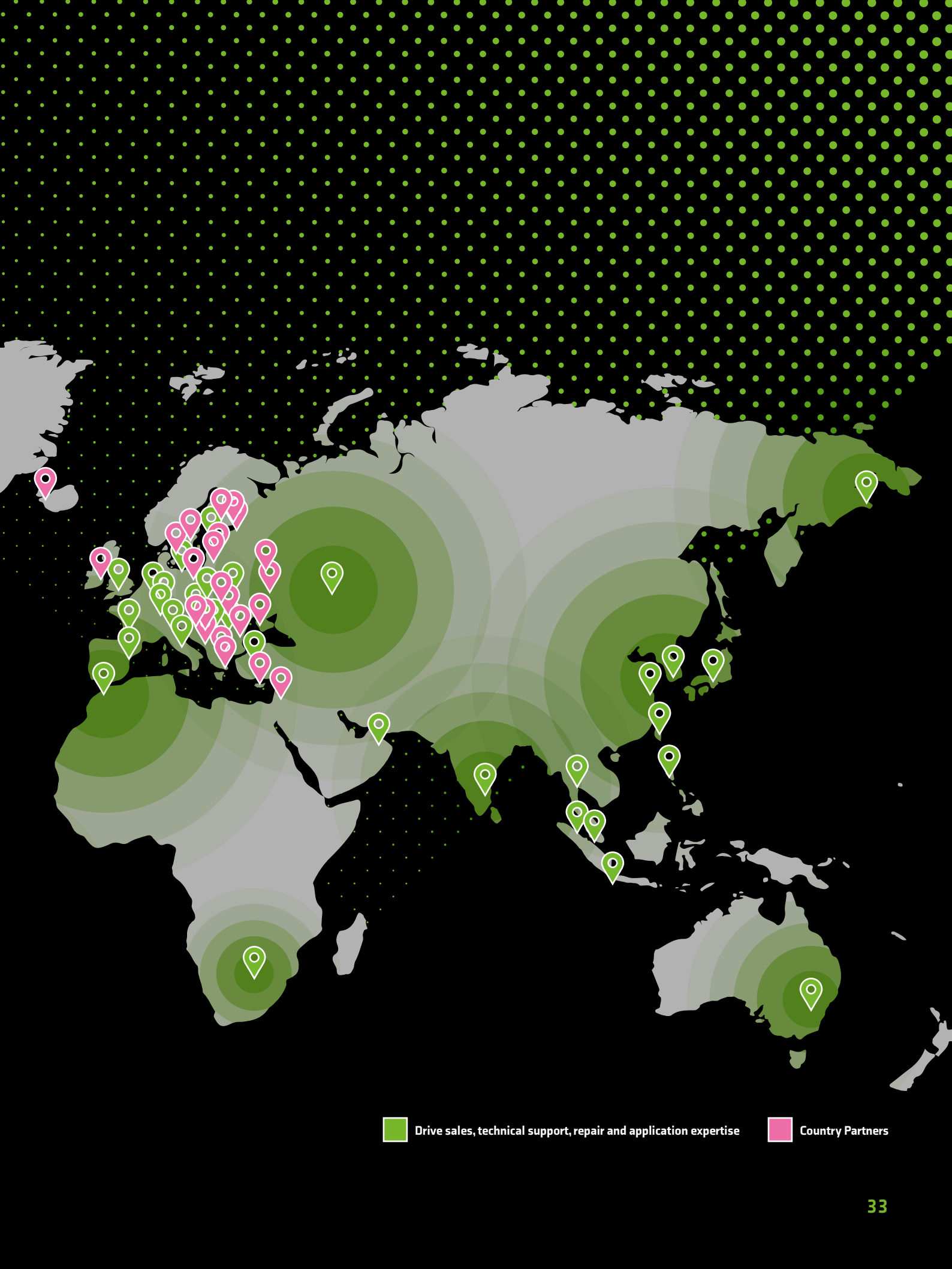

Drive sales, technical support, repair and application expertise



Country Partners



# WORLD-CLASS PERFORMANCE

**The bread and butter of Control Techniques is honing our unique motor control algorithms, taking pride in our craft as any good craftsman would.**

This ensures that our drives offer the highest control stability and bandwidth for every industrial motor type. Our high performance drives enable maximum machine throughput in every application and with every motor, from standard AC induction motors to dynamic linear motors and from energy saving hybrid permanent-magnet motors to high performance servo motors.



# TECHNOLOGY YOU CAN RELY ON

**We design our drives to run at their optimum, even in the harshest of conditions from simple PLC logic of our general-purpose drives, to three axis decentralized control operating four times faster than a standalone PLC machine controller.**

Reliability through process control ensures consistency and peace of mind with drives tested up to 50 times during build stage.

## Ingress

- Conformal coating
- Patented air flow system
- Ingress protection

## Electrical

- Wide supply voltage tolerance, protects against:
  - a. Load shedding
  - b. Brownouts

## Temperature

- Adaptive thermal management
- Intelligent multi-speed fan



# EMBEDDED INTELLIGENCE

**Many of our drives incorporate an easy to use, on-board PLC which can execute programs for logic and sequencing with real-time tasks.**

Our flagship Unidrive M700 series integrates a 1.5 axes Advanced Motion Controller, allowing motion functions to be synchronously carried out on the drive at 250  $\mu$ s cycle time, minimising system latencies and maximising performance. By implementing motion control on the drive, the system design can be liberated from being tied to specific PLC vendors, at the same time reducing the computational load on the external PLC or even replacing it altogether.



# OPEN DESIGN ARCHITECTURE

**Our drives communicate with all common protocols.**

- Total freedom to design your system without limitations
- A simple way to integrate with virtually any machine
- An opportunity to offer customisation without additional development costs
- No systems tie-ins

***"I would recommend these drives to other plants. They are good, tight drives with a flexible interface that makes communication with other equipment easy."***





# RELIABILITY PROCESS CONTROL

Our modern R&D and manufacturing processes ensure consistency to give you peace of mind.

## Test

- We test to destruction, running sample drives on a live rig – 24hrs a day, 365 days a year
- Simulation tools diagnose hidden faults

## Manufacture

- All our staff receive IPC-A-610 training (world standard for ensuring consistency)
- Drives are tested up to 50 times throughout the build stages



# SOCIAL RESPONSIBILITY

As a global operation, Control Techniques takes CSR seriously. We conform to the following management systems:



**ISO 9001:2015**  
Certificate No. Q05176



**ISO 14001:2015**  
Certificate No. EMS54446



**RoHS**  
WEEE



# WEBSITE

You can find all of the following information and support on our website: [www.controltechniques.com](http://www.controltechniques.com)

- Full Product Information
- Service & Support
- Videos
- News
- Downloads:
  - Case studies
  - Engineering guided
  - User guides
  - Brochures
  - Mobile Applications
  - Software Registration



## DRIVEOBSESSED.COM

- New Product Range Videos
- Our NFC Technology
- Branch Launch Event



Connect with us



# TOP SOLUTIONS



## CRANES & HOISTS

# INTEGRATED SPACE-SAVING & SUPERB DYNAMIC RESPONSE



**Company:** NTK Technik GmbH

**Country:** Germany

**Product used:** Unidrive

### Customer profile

Incorporating crane control software into Unidrive AC drives has enabled crane control specialists NTK Technik GmbH to build unique operational features into a new design of crane recently launched by Jost Cranes of Germany.

The operational software used by luffing cranes usually needs to perform static weighing by a load cell after the initial lift, which created an uncomfortable jolt for the operator caused by the start-stop-start of the hoist.

### Solution

Sophisticated crane control software that runs in the drives' application modules was produced. This incorporates two completely new features that include a new method of assessing load during the lift to eliminate the weighing delay - and it's accompanying jolt - and a selectable operating mode that gives a constant load height irrespective of the luffing position of the crane.

### Key benefits

- Unique crane software
- Optimised hoist & speed comfort
- Compact & programmable drives
- Highest level of safety

*"The tower crane company, Jost Cranes of Germany, has adopted the NKT-Technik system for their new generation of topless luffing cranes, which will become the backbone of the company's product line."*





## FANS & PUMPS

# OPERATIONAL PERFORMANCE IMPROVEMENTS

**Company:** Biovet

**Country:** Bulgaria

**Product used:** Unidrive

### Customer profile

**Biovet is one of Bulgaria's largest pharmaceutical companies and is a specialist manufacturer of antibiotic feed additives and pharmaceuticals for farm animals and domestic pets.**

It is crucial that with agitation process, which adds oxygen to the mixture, does not stop as there is a very narrow window and after that the product is scrap.

### Solution

As part of PlantWeb's digital plant architecture, 40 variable speed Control Techniques AC drives of between 100 and 160kW were integrated into the second fermentation area at the plant in Peshtera to control the agitators in the vessels.

The scheme at Production Unit 3 uses seven DeltaV workstations, communicating with 450 field instruments via the Foundation fieldbus protocol, as well as with the drives via Profibus DP.



AMST<sup>™</sup> Suite intelligent device manager software accesses the predictive intelligence of the field devices to enable configuration, calibration & diagnostic tests to be performed.

The drives were configured to ensure that, should the drive approach overload levels, rather than trip out, it would back off to below the motor rated current, set to 90% of the motor current trip limit. This eliminates unnecessary downtime and ensures that the stirring process continues uninterrupted.

### Key benefits

- Increased stability & reliability
- 30% improvement in performance
- 10% labour cost saving

***"The stability and reliability of the new system is outstanding and Biovet has not experienced a single incident that has damaged production or equipment since it was installed.***

***PlantWeb, with its DeltaV<sup>™</sup> digital automation system and modular Unidrives, has resulted in an improvement in operational performance of the fermentation process by 30%."***







FOOD & DRINK

# BIG THINKING FOR TESTING BIG MOTORS

**Company:** Rewinds & J Windor

**Country:** UK

**Product used:** DFS Drive



## Customer profile

Established in 1946, Rewinds & J. Windsor is one of the largest independently owned electric motor and rotating equipment repairers in the UK.

Operating across three sites, the company offers a range of electrical, mechanical, and electronic engineering services across the UK and Ireland. The company's motor testing facility in Liverpool, tests, builds, and repairs a wide range of motors from wind turbines to big brand car motors.

## Solution

**A 500 kW Control Techniques' DFS drive, was just the solution.**

The pre-assembled, ready to install drive cubicle system, is designed for use in high power applications where energy saving and high ingress protection are essential.

## Key benefits

- Increased capacity
- Extends the company's service offer
- Increased flexibility
- Easy to use

*"The Control Techniques' DFS drive cubicle is doing everything we want. The upgrade to the new system has increased our flexibility as a firm. Moving from our old 250 kW drive to 500 kW means we can now test much bigger motors, up to 1 MW in-house, reducing our service costs. We can now take on more work and test and repair other companies motors."*





## MATERIAL HANDLING

# COAL LOADER RELIES ON DRIVES

**Company:** Dalrymple Bay Coal Terminal

**Country:** Australia

**Product used:** Unidrive



### Customer profile

A new shiploader at Dalrymple Bay Coal Terminal at Hay Point Port, Queensland has been fitted with Unidrive AC drives. Between 15 and 18 trains are unloaded at the coal terminal daily (approx 5,500 tonnes per hour) for export, the terminal also serves 14 mines in Queensland.

The expansion added a new berth and shiploader to the existing 2 berths/2 shiploader combination.

### Solution

Control Techniques Australia was awarded the contract by Clough Downer JV and designed a scheme where all drives communicate with a PLC via DeviceNet, with encoder feedback giving closed loop motor control, and additional on-board processing.

### Key benefits

- Compact drives
- Encoder feedback
- On-board processing
- Local support

*“The client was pleased with our solution based on Unidrive AC drives, and drives and switchgear were mounted back-to-back in specially designed compact cubicles. Once installed at Bay, we completed the final commissioning, which was completed very quickly to the client’s full satisfaction.”*





## PACKAGING

# THE VERTICAL PACKAGING REVOLUTION

**Company:** Sabalpack

**Country:** Italy

**Product used:** Digitax

### Customer profile

**Italian company Sabalpack designs and produces innovative packing machine, with Control Techniques drives at the heart of the company's vertical form, fill and seal packaging machines.**

Based on technological advances, Sabalpack manufactures revolutionary vertical packaging machines.

For the company, product quality, repeatability and precision are of utmost importance, as well as minimising waste to keep costs down, all of which is possible thanks to their decision to make Control Techniques drives their drives of choice.

### Key benefits

- Extreme accuracy
- High precision and repeatability
- Format changes quick and easy



### Solution

Sabalpack's flagship 'Leopard' Stabilo line is a range of fully automatic electronic vertical packaging machines fitted with brushless motors to provide the sealing crimper and packaging feed functions.

The Stabilo bag has fourealed corners for strength and stability. Changes in bag size and format can be achieved quickly and easily by the operator entering instructions using the control panel. This information is then sent by Profibus to the SM Applications Plus programmable processor in the Digitax servo drive that runs the crimper motor settings and film feed so the appropriate amount of film is fed for each batch.

*"It is an intelligent solution to the problem of product spillage, focusing more on end results and producing high quality packages. It combines reliability, high performance to increase operating speed, repeatability and accuracy, while at the same time reducing panel sizes and costs."*





## PLASTICS & RUBBER

# 9 MILLION TYRES GET NEW LEASE OF LIFE

**Company:** Bandag

**Country:** South Africa

**Product used:** Unidrive

### Customer profile

Based in Alrode, Johannesburg, Bandag SA is part of the global Bandag Group. This leading retread company specialises in giving new life to truck tyres, enabling them to perform like new but at a fraction of the cost.

Truck fleets are its primary focus; new treads are applied to existing tyres to deliver more mileage over any terrain, using next-generation compounds that resist wear & tear. Worldwide, almost 9 million truck and bus tyres are fitted with Bandag retreads annually, establishing this company as a true industry leader.

Through a network of independent tyre franchises in South Africa, Bandag SA has been providing a much-needed service to the African logistics industry since the 1960s.



### Solution

Having previously installed Control Techniques AC drives on the plant's extruder and Calendar Mill (a process that forms the exudates & processes cushion gum), Multispeed Transmissions concluded that the mixer operation would also benefit from a similar installation.

The Unidrive M700 AC was selected. A high-performance motor control system that provides ultimate control flexibility in high specification industrial applications. Two Unidrive M700's are now connected to a common gearbox, which evenly shares the load throughout the operation.

### Key benefits

- 10% energy savings per month
- 5% increase in uptime
- 6% increase in productivity
- Future-ready solution



## STAGE & THEATRE

# NO DRAMA PROGRAMMING AND OPERATION

**Company:** Trekwerk

**Country:** UK

**Product used:** Unidrive



### Customer profile

As part of a four-year £112 million transformation at the Royal Shakespeare Theatre in Stratford-upon-Avon, Dutch theatre automation company Trekwerk was responsible for the renovation of the over-stage installation. The contract was awarded to Control Techniques' Rotterdam Drive Centre and around 100 AC drives and servo motors were used throughout the project.

The challenge was to automate the movement of back-drops and scenery, and the complex system of lighting arrays, which included the development, design, manufacture & installation of 60 winches plus hoists for 30 light rays.

### Solution

A total of 46 drives were fitted to 60 winches. All were fitted with Control Techniques' 15 kW Unidrive AC drives operating in servo mode & twinned with Unimotor 190 servo motors, fitted with double encoders for precise positioning and speed control.

### Key benefits

- Extremely flexible
- Virtually silent
- Safe operation

*"All drives communicate with each other using Control Techniques' own high-speed network for CT Net, as well as communicating via CT Net with the Trekwerk control system."*



# PROJECTS

# WE ARE DRIVE OBSESSED



# GENERAL PURPOSE DRIVES

## COMMANDER C200 | C300



# COMMANDER C

# SIMPLE, RELIABLE MOTOR CONTROL

0.25kW - 132kW (0.33 hp to 200hp) 100V | 200V | 400V | 575V | 690V

The new Commander C series has been designed to be a simple and reliable AC motor speed controller that meets advanced requirements in a wide range of applications and provides optimum user experience.

### Applications:



Pumping, Ventilating & Compressing



Conveying



Lifting, Hoisting & Winching



Access Control



Processing  
(Mixers, Crushers, Agitators, Centrifuges, Extruders)



### Free 5 year warranty

The Commander C series has a highly robust design to cope with harsh environments. It has proven exceptionally reliable and we feel so assured about this that we have given it a free 5 year warranty.

Now you can buy with the same confidence.

Warranty terms and conditions apply.

# KEY GENERAL PURPOSE FUNCTIONS

Function		Function	
Jog	✓	Supply loss detection	✓
Bi-polar reference	✓	Low DC link operation	✓
Pre-set speeds	8	Analogue input control	✓
Preset timer	✓	Analogue output control	✓
Skip frequencies	3	Temperature monitoring	✓
Skip frequency dead bans	✓	Digital input control	✓
Local/Remote	✓	Digital output control	✓
S-Ramp	✓	Relay control	✓
Acceleration Rates	✓	Mechanical Brake Controller	✓
Deceleration Rates	8	Keypad button assignment	✓
Pulse train frequency reference	0 - 100kHz	Motorised pot	✓
Torque reference	✓	Logic function control	✓
Control mode: Linear V/f	✓	Timer function control	✓
Control mode: Quadratic V/f	✓	Limit switch control	✓
Control mode: Dynamic V/f	✓	Variable selector	✓
Control mode: Set Point V/f	✓	PID Control	✓
Stator resistance compensation	✓	Energy meter	✓
Slip compensation	✓	Trip time stamping	✓
Auto-tune static	✓	Trip logging	8
Auto-tune rotating	✓	Run time log	✓
Catch a spinning motor	✓	Control word control	✓
Stop mode: Ramp	✓	Auto reset	✓
Stop mode: Coast	✓	Cloning	✓
Stop mode: Fast Ramp	✓	On-board PLC	30kb
DC injection braking	✓	Additional Application parameters	64
Programmable braking	✓	Second motor set-up	✓
Motor Pre-heat control	✓	Speed feedback via options	✓

# SPECIFICATION

Environment	
Ambient Operating Temperature	Size 1 - 4: -20°C to 40°C (-4°F to 104°F) @ 3 kHz switching freq.   Operation to 60°C (140°F) with de-rating Size 5 - 9: -20°C to 40°C (-4°F to 104°F) @ 3 kHz switching freq.   Operation to 55°C (131°F) with de-rating
Cooling method	Forced convection
Humidity	95 % non-condensing at 40 °C (104 °F)
Storage Temperature	Size 1 - 4: -40°C to 60°C (-40°F to 140°F) — 24 months Max. Size 5 - 9: -40°C to 55°C (-40°F to 131°F) — 24 months Max.
Altitude	De-rate the continuous output current by 1% for every 100 m (328 ft) above 1000 m (3,280 ft) to a maximum of 3000 m (9,840 ft)
Vibration	Tested in accordance with IEC 60068-2-64 and IEC 60068-2-6
Mechanical Shock	Tested in accordance with IEC 60068-2-27 and IEC 60068-2-29
Enclosure Rating	IP20, NEMA 1 conduit kits available
Electromagnetic Capability	IEC/ EN 61800-3 Immunity and Emissions EN 61000-6-2: Immunity for industrial environments EN 61000-6-4: Emissions for industrial environments EN 61000-3-2: Harmonic current emissions An EMC data sheet is available on request
RoHS	Complies with the Restriction of Hazardous Substances Directive (2011/65/EU)
AC Supply Requirements	
Voltage	100 V models: 100 to 120 Vac ±10% 200 V models: 200 to 240 Vac ±10% 400 V models: 380 to 480 Vac ±10%
	575 V models: 500 to 575 V±/-10% 690 V models: 500 to 690 V±/-10%
Phases	1Ø and 3Ø (Model dependent)
Maximum Supply Imbalance	2% negative phase sequence, 3% voltage imbalance between phases
Input Frequency	45 to 66 Hz
Input Displacement Power Factor	0.97
Switching Frequency	Size 1 - 4: 0.667, 1, 2, 3, 4, 6, 8, 12 & 16 kHz Size 5 - 9: 2, 3, 4, 6, 8, 12 & 16 kHz
Output Frequency Range	0 to 550 Hz
Frequency Accuracy	±0.02% of full scale
Frequency Resolution	0.01 Hz
Analog Input Resolution	Voltage mode: 11 bits (unipolar) Current mode: 11 bits
Braking	Dynamic braking transistor included, requires external resistor

Protection			
DC Bus Undervoltage Trip	100 V models: 175 Vdc 200 V models: 175 Vdc	400 V models: 330 Vdc 575 V models: 435 Vdc	690 V models: 435 Vdc
DC Bus Overvoltage Trip	Frame sizes 1 - 4: 100 V models: 510 Vdc	200 V models: 510 Vdc	400V models: 870 Vdc
	Frame size 5 - 9: 200V models: 415 Vdc 400 V models: 830 Vdc	575 V models: 990 Vdc 690 V models: 1190 Vdc	
Drive Overload Trip	Programmable: Default settings: 180% for 3s, 150% for 60s		
Instantaneous Overcurrent Trip	220% of rated motor current		
Phase Loss Trip	DC bus ripple threshold exceeded		
Over-temperature Trip	Drive heatsink temperature exceeds 95°C (203°F)		
Short Circuit Trip	Protects against output phase-to-phase fault		
Ground Fault Trip	Protects against output phase-to-ground fault		
Motor Thermal Trip	Electronically protects the motor from overheating due to loading conditions		

Approval & Listings	
UL, cUL	UL file NMMS/8: E171230
CE	CE approval
EU	These products comply with the Restriction of Hazardous Substances Directive (2011/65/EU), the Low Voltage Directive (2014/35/EU) and the Electromagnetic Compatibility Directive, (2014/30/EU).
RCM	RCM Registered supplier No. 12003815281
ISO	Manufacturing facilities comply with ISO 9001:2015 and ISO 14001
TÜV	C300 models only: The Safe Torque Off (STO) function may be used as a safety component of a machine. Type examination certificates by TÜV Rheinland: Frame sizes 1 - 4: No. 01/205/5383.03/18 Frame sizes 5 - 9: No. 01/205/5387.02/18 Functional safety parameters: EN ISO 13849-1 - Cat 4, PLe EN61800-5-2/EN62061/IEC 61508 - SIL 3 UL functional safety approval: FSPC E171230
EAC	RU C-GB.HA10.B.01062

## Documentation & Downloads

Product documentation and PC tools available for download from:  
[www.controltechniques.com/support](http://www.controltechniques.com/support)

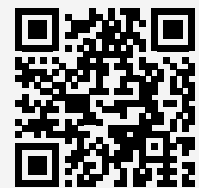

# DIMENSIONS

Frame Size	Overall Dimensions						Mounting Dimensions				Mounting Hole Diameter		Weight	
	mm			in			mm		in		mm	in	kg	lb
	H	W	D	H	W	D	H	W	H	W				
1	160	75	130	6.3	2.95	5.1	143	53	5.7	2.08	5	0.2	0.75	1.65
2	205	75	150	8.07	2.95	5.9	194	55	7.63	2.17	5	0.2	1.3	3
3	226	90	160	8.9	3.54	6.3	215	70.7	8.46	2.8	5	0.2	1.5	3.3
4	277	115	175	10.9	4.5	6.9	265	86	10.43	3.4	6	0.23	3.13	6.9
5	391	143	200	15.39	5.63	7.87	375	106	14.76	4.17	6.5	0.26	7.4	16.3
6	291	210	227	15.39	8.27	8.94	378	196	14.88	7.72	7	0.28	14	30.9
7	557	270	280	21.93	10.63	11.02	538	220	21.18	8.66	9	0.35	28	61.7
8	804	310	290	31.65	12.21	11.42	884	259	30.87	10.2	9	0.35	52	114.6
9E	1069	310	290	42.09	12.21	11.42	1051	259	41.38	10.2	9	0.35	46	101.4
9A	1108	310	290	43.62	12.21	11.42	1090	259	42.91	10.2	9	0.35	66.5	146.6



# CONNECTIONS

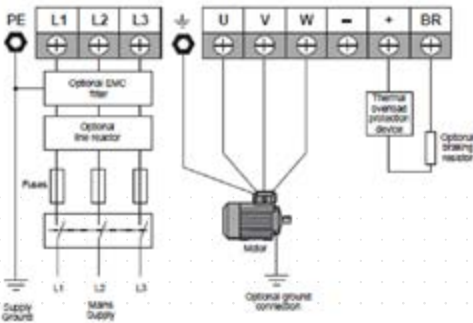

Typical Power Connections

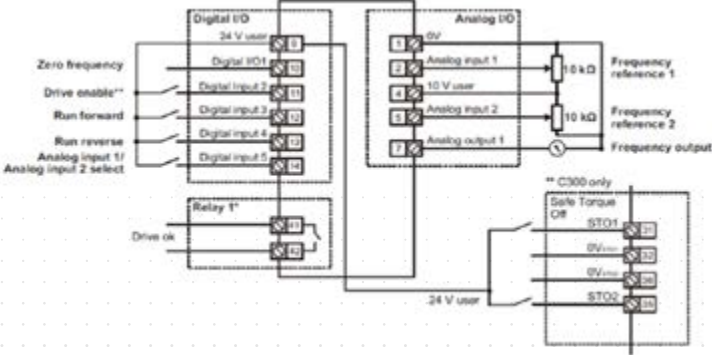

Default Control Connections

# PART NUMBERS

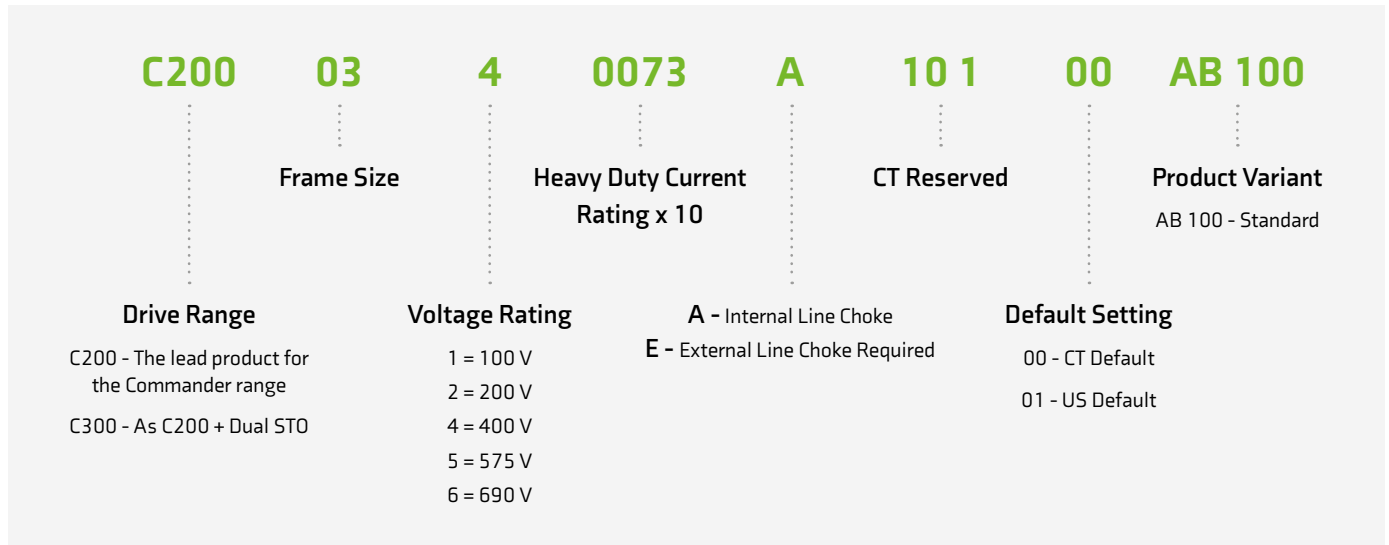

**Note:** For the STO variants just replace the C200 digits at the start of the part number with C300.

# ORDERING GUIDE

## How to select a drive

### Electrical Considerations

- What is the supply voltage?
- Single or three phase input power?
- What is the motor rating?
- Continuous current – FLA (Full Load Amps)
- Select the drive based on motor Amps rather than kilowatt/horsepower rating

### Drive Mechanical Mounting

- Panel mounting – as standard
- Wall mounting – UL conduit kits are available
- Through panel mounting – frames 5 and up

# MODEL NUMBER AND RATINGS

Product Code	Size	Input Phases	Heavy Duty			Normal Duty		
			Max Cont. Current (A)	Motor Power (kW)	Motor Power (HP)	Max Cont. Current (A)	Motor Power (kW)	Motor Power (HP)
<b>100/200 VAC +/-10%</b>								
C200-01100017A10100AB100	01	1	1.7	0.25	0.33			
C200-01100024A10100AB100	01	1	2.4	0.25	0.5			
C200-02100042A10100AB100	02	1	4.2	0.75	1			
C200-02100056A10100AB100	02	1	5.6	1.1	1.5			
<b>200/240 VAC +/-10%</b>								
C200-01200024A10100AB100	1	1	2.4	0.37	0.5			
C200-01200033A10100AB100	1	1	3.3	0.55	0.75			
C200-01200042A10100AB100	1	1	4.2	0.75	1			
C200-02200024A10100AB100	2	1 3	2.4	0.37	0.5			
C200-02200033A10100AB100	2	1 3	3.3	0.55	0.75			
C200-02200042A10100AB100	2	1 3	4.2	0.75	1			
C200-02200056A10100AB100	2	1 3	5.6	1.1	1.5			
C200-02200075A10100AB100	2	1 3	7.5	1.5	2			
C200-03200100A10100AB100	3	1 3	10	2.2	3			
C200-04200133A10100AB100	4	1 3	13.3	3	3			
C200-04200176A10100AB100	4	3	17.6	4	5			
C200-05200250A10100AB100	5	3	25	5.5	7.5	30	7.5	10
C200-06200330A10100AB100	6	3	33	7.5	10	50	11	15
C200-06200440A10100AB100	6	3	44	11	15	58	15	20
C200-07200610A10100AB100	7	3	61	15	20	75	18.5	25
C200-07200750A10100AB100	7	3	75	18.5	25	94	22	30
C200-07200830A10100AB100	7	3	83	22	30	117	30	40
C200-08201160A10100AB100	8	3	116	30	40	149	37	50
C200-08201320A10100AB100	8	3	132	37	50	180	45	60
C200-09201760A10100AB100	9	3	176	45	60	216	55	75
C200-09202190A10100AB100	9	3	219	55	75	266	75	100

For Normal Duty applications, use Heavy Duty ratings.

For Normal Duty applications, use Heavy Duty ratings.

Product Code	Size	Input Phases	Heavy Duty			Normal Duty		
			Max Cont. Current (A)	Motor Power (kW)	Motor Power (HP)	Max Cont. Current (A)	Motor Power (kW)	Motor Power (HP)
C200-09201760E10100AB100	9	3	176	45	60	216	55	75
C200-09202190E10100AB100	9	3	219	55	75	266	75	100
C200-02200056A10100AB100	2	1 3	5.6	1.1	1.5	For Normal Duty applications, use Heavy Duty ratings.		
C200-02200075A10100AB100	2	1 3	7.5	1.5	2			
C200-03200100A10100AB100	3	1 3	10	2.2	3			
C200-04200133A10100AB100	4	1 3	13.3	3	3			
C200-04200176A10100AB100	4	3	17.6	4	5			
C200-05200250A10100AB100	5	3	25	5.5	7.5			
C200-06200330A10100AB100	6	3	33	7.5	10	50	11	15
C200-06200440A10100AB100	6	3	44	11	15	58	15	20
C200-07200610A10100AB100	7	3	61	15	20	75	18.5	25
C200-07200750A10100AB100	7	3	75	18.5	25	94	22	30
C200-07200830A10100AB100	7	3	83	22	30	117	30	40
C200-08201160A10100AB100	8	3	116	30	40	149	37	50
C200-08201320A10100AB100	8	3	132	37	50	180	45	60
C200-09201760A10100AB100	9	3	176	45	60	216	55	75
C200-09202190A10100AB100	9	3	219	55	75	266	75	100
C200-09201760E10100AB100	9	3	176	45	60	216	55	75
C200-09202190E10100AB100	9	3	219	55	75	266	75	100



Product Code	Size	Input Phases	Heavy Duty			Normal Duty		
			Max Cont. Current (A)	Motor Power (kW)	Motor Power (HP)	Max Cont. Current (A)	Motor Power (kW)	Motor Power (HP)
<b>380/480 VAC +/-10%</b>								
C200-02400018A10100AB100	2	3	1.8	0.55	0.75			
C200-02400023A10100AB100	2	3	2.3	0.75	1			
C200-02400032A10100AB100	2	3	3.2	1.1	1.5			
C200-02400041A10100AB100	2	3	4.1	1.5	2			
C200-03400056A10100AB100	3	3	5.6	2.2	3			
C200-03400073A10100AB100	3	3	7.3	3	3			
C200-03400094A10100AB100	3	3	9.4	4	5			
C200-04400135A10100AB100	4	3	13.5	5.5	7.5			
C200-04400170A10100AB100	4	3	17	7.5	10			
C200-05400270A10100AB100	5	3	27	11	20	30	15	20
C200-05400300A10100AB100	5	3	30	15	20	30	15	20
C200-06400350A10100AB100	6	3	35	15	25	38	18.5	25
C200-06400420A10100AB100	6	3	42	18.5	30	48	22	30
C200-06400470A10100AB100	6	3	47	22	30	63	30	40
C200-07400660A10100AB100	7	3	66	30	50	79	37	50
C200-07400770A10100AB100	7	3	77	37	60	94	45	60
C200-07401000A10100AB100	7	3	100	45	75	112	55	75
C200-08401340A10100AB100	8	3	134	55	100	155	75	100
C200-08401570A10100AB100	8	3	157	75	125	184	90	125
C200-09402000A10100AB100	9	3	200	90	150	221	110	150
C200-09402240A10100AB100	9	3	224	110	150	266	132	200
C200-09402000E10100AB100	9	3	200	90	150	221	110	150
C200-09402240E10100AB100	9	3	224	110	150	266	132	200

For Normal Duty applications, use Heavy Duty ratings.

Product Code	Size	Input Phases	Heavy Duty			Normal Duty		
			Max Cont. Current (A)	Motor Power (kW)	Motor Power (HP)	Max Cont. Current (A)	Motor Power (kW)	Motor Power (HP)
<b>500/575 VAC +/-10%</b>								
C200-05500040A10100AB100	5	3	4	2.2	3	6.1	4	5
C200-05500069A10100AB100	5	3	6.9	4	5	10	5.5	7.5
C200-06500100A10100AB100	6	3	10	5.5	7.5	12	7.5	10
C200-06500150A10100AB100	6	3	15	7.5	10	17	11	15
C200-06500190A10100AB100	6	3	19	11	15	22	15	20
C200-06500230A10100AB100	6	3	23	15	20	27	18.5	25
C200-06500290A10100AB100	6	3	29	18.5	25	34	22	30
C200-06500350A10100AB100	6	3	35	22	30	43	30	40
C200-07500440A10100AB100	7	3	44	30	40	53	37	50
C200-07500550A10100AB100	7	3	55	37	50	73	45	60
C200-08500630A10100AB100	8	3	63	45	60	86	55	75
C200-08500860A10100AB100	8	3	86	55	75	108	75	100
C200-09501040A10100AB100	9	3	104	75	100	125	90	125
C200-09501310A10100AB100	9	3	131	90	125	150	110	150
C200-09501040E10100AB100	9	3	104	75	100	125	90	125
C200-09501310E10100AB100	9	3	131	90	125	150	110	150
<b>500/690 VAC +/-10%</b>								
C200-07600240A10100AB100	7	3	24	18.5	25	30	22	30
C200-07600290A10100AB100	7	3	29	22	30	36	30	40
C200-07600380A10100AB100	7	3	38	30	40	46	37	50
C200-07600440A10100AB100	7	3	44	37	50	52	45	60
C200-07600540A10100AB100	7	3	54	45	60	73	55	75
C200-08600630A10100AB100	8	3	63	55	75	86	75	100
C200-08600860A10100AB100	8	3	86	75	100	108	90	125
C200-09601040A10100AB100	9	3	104	90	125	125	110	150
C200-09601310A10100AB100	9	3	131	110	150	150	132	175
C200-09601040E10100AB100	9	3	104	90	125	125	110	150
C200-09601310E10100AB100	9	3	131	110	150	150	132	175















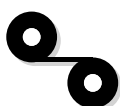

# HIGH PERFORM ANCE DRIVES

## UNIDRIVE

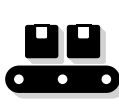
# PRODUCTS IN THIS RANGE

M700/M701/M702 | M600 | M400 | EXTREME POWER

## UNIDRIVE Applications:

- |   |                    |   |             |   |   |
|---|--------------------|---|-------------|---|---|
|  | Hoists             |  | Winding     |  | Cutting   |
|  | Woodworking        |  | Test Stands |  | Printing  |
|  | Web Handling       |  | Textiles    |  | Packaging Machines  |
|  | Tyre Manufacturing |  | Extrusion   |  | Metals  |
|  | Mining             |  | Marine      |  | Speed & Position Control<br>(For Gearing & Ratio Control) |



# UNIDRIVE M700, M701 & M702 ADVANCED MOTOR CONTROL

0.75 kW – 2.8 MW (1.0 - 4,200 hp) 200 V | 400 V | 575 V | 690 V

## Performance control matched for every type of motor.

**Our Unidrive M700 drives offer the control stability and bandwidth for every industrial motor type.**

Unidrive M enables maximum machine throughput in every application and with every motor, from AC induction motors to dynamic linear motors and from energy saving hybrid permanent-magnet motors to high performance servo motors.

## Key Benefits:

- High bandwidth motor control
- Universally applicable to control multiple parts of the application
- Built-in ultra-flexible speed and position feedback interface
- Sensorless control of induction, permanent-magnet, and hybrid PM motors
- Integrated safety with optional motion safety functions
- Comprehensive communications supporting a multitude of control bus technologies
- Scalable machine control architecture
- Uncompromised high performance control at high powers



# KEY FUNCTIONS

Function		Function	
Jog	✓	Supply loss detection	✓
Bi-polar reference	✓	Low DC link operation	✓
Pre-set speeds	8	Analogue input control	✓
Preset timer	✓	Analogue output control	✓
Skip frequencies	3	Temperature monitoring	✓
Skip frequency dead bands	✓	Digital input control	✓
Local/Remote	✓	Digital output control	✓
S-Ramp	✓	Relay control	✓
Acceleration Rates	8	Mechanical Brake Controller	✓
Deceleration Rates	8	Keypad button assignment	✓
Torque reference	✓	Motorised pot	✓
Control mode: Linear V/f	✓	Logic function control	✓
Control mode: Open-loop vector	✓	Timer function control	✓
Control mode: Quadratic V/f	✓	Limit switch control	✓
Stator resistance compensation	✓	Variable selector	✓
Slip compensation	✓	PID Control	✓
Sensorless control of induction motors	✓	Energy meter	✓
Sensorless control of permanent magnet motors	✓	Trip time stamping	✓
Auto-tune static (including permanent magnet motors)	✓	Trip logging	8
Auto-tune rotating	✓	Run time log	✓
Catch a spinning motor	✓	Control word control	✓
Stop mode: Ramp	✓	Auto reset	✓
Stop mode: Coast	✓	Cloning	✓
Stop mode: Fast Ramp	✓	On-board PLC	16kb
DC injection braking	✓	Additional Application parameters	148
Programmable braking	✓	Second motor set-up	✓
Motor Pre-heat control	✓	Speed feedback via options	✓

# SPECIFICATION

## Unidrive M700, M701 & M702

Items supplied with the drive	Control Getting Started Guide, Power Installation Guide, Safety Information, Quality Certificate, Control signal connectors, 24V power supply connector (frames 6 to 11), Grounding bracket, Surface mounting brackets, DC connection grommets (frames 3 to 6), Supply and motor connectors (frames 3 to 5), Nuts for supply and motor terminals (frames 6 to 11)
Storage temperature	-40°C to 55°C, -40°F to 131°F
Operating temperature without de-rate	-20°C to 40°C, -4°F to 104°F
Operating temperature with de-rate	40°C to 55°C, 104°F to 131°F
Supply requirements	Maximum supply imbalance: 2 % negative phase sequence (equivalent to 3 % voltage imbalance between phases). Input frequency 45 to 66Hz
Switching frequency range	2,3,4,6,8,12,16kHz (Factory default = 3kHz Open-loop/RFC-A, 6kHz RFC-S)
Approvals	CE (European Union), cUL Listed (USA and Canada), DNV (marine applications), RCM (Australia/ New Zealand), EAC (Russian Customs Union)
Product safety standard	EN61800-5-1
Functional safety (Single STO function)	Independently assessed by TÜV to IEC 61800-5-2 SIL 3 and EN ISO 13849-1 PL
Altitude	1000m – No de-rate. 1000m to 3000m - 1% de-rate/100m
Humidity	95% Non-condensing at 40 °C (104 °F)
Pollution	Degree 2. Dry, non-conducting pollution only
IP Rating	IP20 / NEMA1 / UL TYPE 1 (UL open class as standard, additional kit needed to achieve Type 1) IP65 / NEMA4 / UL TYPE 12 rating on the rear of drive when through panel mounted (Frames 3 to 8) IP55 / NEMA4 / UL TYPE 12 rating on the rear of drive when through panel mounted (Frames 9 to 11)
Vibration	Reference standard IEC60068-2-27, IEC60068-2-29 bump test, IEC60068-2-64 random vibration test, IEC60068-2-6, EN61800-5-1 sinusoidal vibration test. Tested to Environmental Category ENV3.
Mounting methods	Frame 3 to 11 – Surface mount via supplied mounting brackets or through-panel mount via optional mounting brackets Frame 3 to 5 – Tile mount via optional mounting brackets
Output frequency/speed range	599Hz (Open-loop), 560Hz (RFC-A, RFC-S)
Braking	In-built braking transistor, optional internal resistor on frame 3 to 5 or external resistor (all frames)
Operating modes	Open-loop: Open-loop vector, fixed V/F, quadratic V/F RFC-A: Rotor Flux Control for Asynchronous motors, with or without position feedback RFC-S: Rotor Flux Control for Synchronous motors, with or without position feedback Regen: For use as a regenerative front end for four quadrant operation



<b>Overload capability</b>	Normal duty (cold): Open-loop – 110% for 165s, RFC – 110% for 165s Heavy duty (cold): Open-loop – 150% for 60s, RFC – 200% for 28s (size 8 and below) Heavy duty (cold): Open-loop – 136% for 81s, RFC – 175% for 42s (size 9, 10, 11)
<b>Overvoltage category</b>	Evaluated for OVC III.
<b>Corrosive environments</b>	Concentrations of corrosive gases must not exceed the levels given in: Table A2 of EN 50178:1998, Class 3C2 of IEC 60721-3-3  This corresponds to the levels typical of urban areas with industrial activities and/or heavy traffic, but not in the immediate neighbourhood of industrial sources with chemical emissions.
<b>Immunity Compliance</b>	IEC61800-3, IEC 61000-4-2, IEC 61000-4-3, IEC61000-4-4, IEC61000-4-5, IEC61000-4-6, IEC61000-4-8, IEC61000-4-11, IEC61000-6-1, IEC 61000-6-2.
<b>Emission compliance</b>	Capable of meeting the requirements of Equipment Category C3 without external filters or line reactors. Capable of meeting the requirements of Equipment Category C2 when installed with the recommended filters and line reactors.  IEC61800-3, EC61000-6-4, EN61000-3-2, EN61000-3-12, EN61000-3-3, EN12015
<b>Cooling</b>	Forced cooled
<b>Safe Torque Off</b>	Single Channel STO, SIL3. M702 has Dual Channel STO, SIL3
<b>Communications</b>	M700 & M702: Ethernet, EtherNet/IP, Modbus/TCP, RTMoE and PROFINET RT M701: RS485, Modbus RTU  SI Options: EtherCAT, PROFIBUS, Ethernet, DeviceNET, CANopen, PROFINET, MiS210, POWERLINK
<b>Control I/O</b>	3 x Analogue input (1 x differential, 2 x single ended), 2 x Analogue output, 3 x Digital I/O programmable, 3 x Digital input (including 2 x high speed – 250µs), 1 x NO relay 250Vac Max., 6 x 0V common, 1 x 24V supply input, 1 x 24V user output, 1 x 10V user output, 1 x Safe Torque Off input. Additional I/O available with SI-I/O option module.
<b>Supported Feedback Devices</b>	Supports a combination of up to two of the following encoders and a simulated encoder output from a single high density connector:  Quadrature incremental with/without marker pulse, with/without UVW commutation signals  Forward / reverse incremental with/without marker pulse, with/without commutation signals  Frequency / direction incremental with/without marker pulse, with/without UVW commutation signals  Sincos incremental with/without commutation signals  Heidenhain sincos incremental with EnDat absolute position  Stegmann sincos incremental with Hiperface absolute position  Sincos incremental with SSI absolute position  Sincos incremental with BiSS (type C) absolute position  Sincos incremental with sincos absolute position  SSI (Gray code or binary) absolute position  EnDat only absolute position  BiSS (type C) only absolute position  Resolver  UVW commutation only
<b>Resolution and Accuracy</b>	Frequency/speed accuracy: 0.01% (preset speed)  Open loop resolution – Preset reference: 0.1 Hz, Precision reference: 0.001 Hz  Closed loop resolution: Preset reference: 0.1 rpm, Precision reference: 0.001 rpm  Analog input 1: 11 bit plus sign, Analog input 2: 11 bit plus sign  Current resolution: 10 bit plus sign, Current accuracy: typical 2%
<b>Onboard advanced motion controller</b>	Advanced 1.5 axes Motion Controller, key features include: – Real-time tasks – 250 µs cycle time – Motion profile generator – Electronic gearbox – Interpolated CAM – Homing functions – High speed position freeze

On-Board user program capability	16kB, IEC 61131-3 compliant
Optional Second Processor (PLC / Motion)	SI-Applications Plus: allows existing SyPTPro application programs to be re-compiled for M70x MCI200: Advanced Machine Controller using industry standard IEC61131-3 programming languages MCI210: Extended Advanced Machine Controller using industry standard IEC61131-3 programming languages with simultaneous connectivity to 2 separate Ethernet networks
Keypad	Optional LCD keypad with or without real-time clock Optional Remote LCD keypad with or without real-time clock
Parameter backup and cloning	Smartcard and SD card (using SD card adapter)
PC Tools	'Connect' commissioning and cloning tool including CT Oscilloscope, Machine Control Studio for On-board PLC programming.
Warranty	26 months
Supported options	RTC Remote Keypad, KI-485 Adapter, HMI, RS485-Communications lead, SI-EtherCAT, SU-PROFIBUS, SI-Ethernet, SI-DeviceNET, SI-CANopen, SI-PROFINET, SI-I/O, SI-Encoder (speed feedback), SI-Universal Encoder (speed feedback), SI-Applications Plus, SI Applications Compact, MCI200, MCI210, SI-Safety, Remote I/O, Smartcard, SD card (using SD card adapter)
Accessories	Through-hole IP65 mounting kit, UL type conduit kits, SP Retrofit mounting brackets, External EMC filters, Grounding bracket (supplied with the drive)

# DIMENSIONS

Frame Size	Overall Dimensions						Mounting Dimensions				Mounting Hole Diameter		Weight	
	mm			in			mm		in		mm	in	kg	lb
	H**	W	D	H**	W	D	H	W	H	W				
3	365	83	200	14.37	3.27	7.87	370	73	14.57	2.87	5	0.2	4.0*	8.8*
													4.5	9.9
4	365	124	200	14.37	4.88	7.87	375	106	14.76	4.17	6	0.23	6.5	14.3
5	365	143	200	14.37	5.63	7.87	375	106	14.76	4.17	6.5	0.26	7.4	16.3
6	365	210	227	14.37	8.27	8.94	378	196	14.88	7.72	7	0.28	14	30.9
7	508	270	280	20	10.63	11.02	538	220	21.18	8.66	9	0.35	28	61.7
8	753	310	290	29.65	12.21	11.42	884	259	30.87	10.2	9	0.35	52	114.6
9E/ 10E	1010	310	290	39.7	12.21	11.42	1051	259	41.38	10.2	9	0.35	46	101.4
9A	1049	310	290	41.3	12.21	11.42	1090	259	42.91	10.2	9	0.35	66.5	146.6
11E	1190	310	312	46.9	12.2	48.9	1222	259	48.11	10.2	9	0.35	63	138.9



\* 034300078, 034300100 weigh 4.5 kg (9.9 lbs), all other variants weigh 4.0 kg (8.8 lbs)

\*\* Overall dimensions do not include removable mounting brackets

# CONNECTIONS

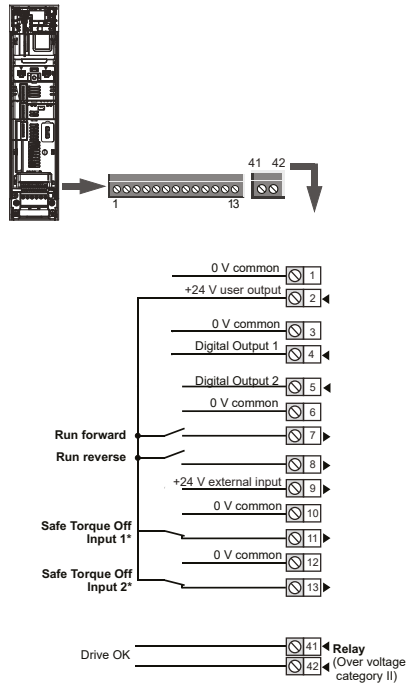
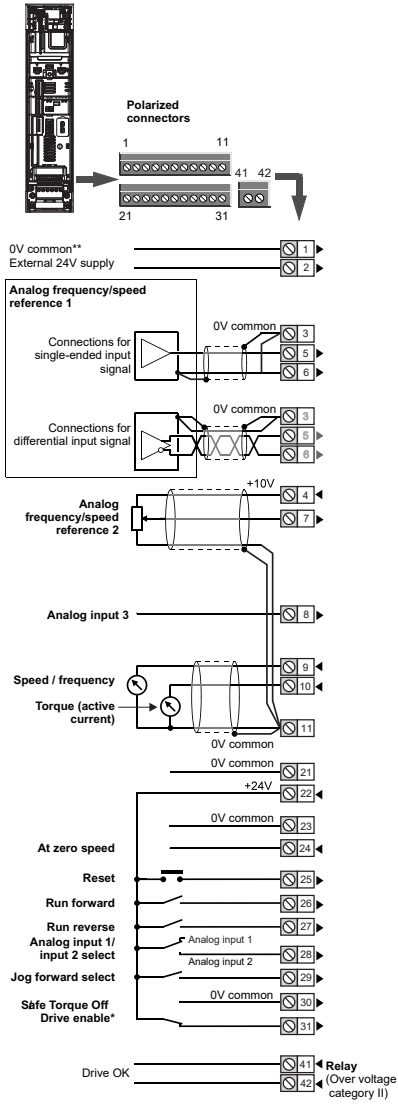

## M702: Default Control Connections

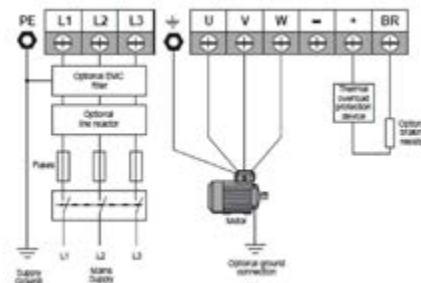

## M700/M701: Default Control Connections

## Typical Power Connections

# PART NUMBERS

<b>M70x</b>	<b>03</b>	<b>4</b>	<b>00078</b>	<b>A</b>
Model:	Frame Size 3 to 11	Voltage Rating:	Heavy Duty Current Rating x 10	Drive Format
M700		2 = 200V (200V-240 +/-10%)		A = AC in AC out, internal choke*
M701		4 = 400V (380V-480V +/-10%)		D = DC in AC out, inverter
M702		5 = 575V (500V-575V +/-10%)		C = AC in DC out, rectifier
		6 = 690V (500V-690V +/-10%)		E = AC in AC out, external choke*
				T = AC in AC out, 12P rectifier plus inverter

\*A designation with internal choke is everything below and including Frame size 9.

E, external choke is Frame sizes 9, 10, 11.

x = 0, 1 or 2

# MODEL NUMBER AND RATINGS

Model No*	Frame Size	Heavy Duty					Normal Duty			
		Rated Current (A)	Motor Shaft Power		Peak Current Open Loop (A)	Peak Current RFC (A)	Rated Current (A)	Motor Shaft Power		Peak Current (A)
			(kW)	(HP)				(kW)	(HP)	
<b>200 V (200 - 240 V ± 10 %)</b>										
M70x-03200050A	3	5	0.75	1	7.8	10	6.6	1.1	1.5	7.26
M70x-03200066A	3	6.6	1.1	1.5	10.3	13.2	8	1.5	2	8.8
M70x-03200080A	3	8	1.5	2	12.4	16	11	2.2	3	12.1
M70x-03200106A	3	10.6	2.2	3	16.5	21.2	12.7	3	3	13.97
M70x-04200137A	4	13.7	3	3	21.3	27.4	18	4	5	19.8
M70x-04200185A	4	18.5	4	5	28.8	37	25	5.5	7.5	27.5
M70x-05200250A	5	25	5.5	7.5	38.9	50	30	7.5	10	33
M70x-06200330A	6	33	7.5	10	51.3	66	50	11	15	55

Model No*	Frame Size	Heavy Duty					Normal Duty			
		Rated Current (A)	Motor Shaft Power		Peak Current Open Loop (A)	Peak Current RFC (A)	Rated Current (A)	Motor Shaft Power		Peak Current (A)
			(kW)	(HP)				(kW)	(HP)	
M70x-06200440A	6	44	11	15	68.4	88	58	15	20	63.8
M70x-07200610A	7	61	15	20	94.9	122	75	18.5	25	82.5
M70x-07200750A	7	75	18.5	25	116.7	150	94	22	30	103.4
M70x-07200800A	7	80	22	30	124.5	166	80	30	40	128.7
M70x-07200830A	7	83	22	30	129.1	166	117	30	40	128.7
M70x-08201160A	8	116	30	40	180.4	232	149	37	50	163.9
M70x-08201320A	8	132	37	50	205.3	264	180	45	60	198
M70x-09201760A/E	9	176	45	60	239.6	308	216	55	75	237.6
M70x-09202190A/E	9	219	55	75	298.1	383.25	266	75	100	292.6
M70x-10202830E	10	283	75	100	385.2	495.25	325	90	125	357.5
M70x-10203000E	10	300	90	125	408.3	525	360	110	150	396
<b>400 V (380 - 480 V ± 10 %)</b>										
M70x-03400025A	3	2.5	0.75	1	3.9	5	3.4	1.1	1.5	3.74
M70x-03400031A	3	3.1	1.1	1.5	4.8	6.2	4.5	1.5	2	4.95
M70x-03400045A	3	4.5	1.5	2	7	9	6.2	2.2	3	6.82
M70x-03400062A	3	6.2	2.2	3	9.6	12.4	7.7	3	5	8.47
M70x-03400078A	3	7.8	3	5	12.1	15.6	10.4	4	5	11.44
M70x-03400100A	3	10	4	5	15.6	20	12.3	5.5	7.5	13.53
M70x-03400135A	3	13.5	5.5	7.5	31.5	40.5	13.5	5.5	7.5	40.5
M70x-03400160A	3	16	5.5	10	37.3	48	16	5.5	10	48
M70x-04400150A	4	15	5.5	10	23.3	30	18.5	7.5	10	20.35
M70x-04400172A	4	17.2	7.5	10	26.8	34.4	24	11	15	26.4
M70x-05400220A	5	22	9	15	34.2	44	27	11	20	29.7
M70x-05400270A	5	27	11	20	42	54	30	15	20	33
M70x-05400300A	5	30	15	20	46.7	60	31	15	20	34.1
M70x-06400350A	6	35	15	25	54.4	70	38	18.5	25	41.8
M70x-06400420A	6	42	18.5	30	65.3	84	48	22	30	52.8
M70x-06400470A	6	47	22	30	73.1	94	63	30	40	69.3
M70x-07400660A	7	66	30	50	102.7	132	79	37	50	86.9
M70x-07400770A	7	77	37	60	119.8	154	94	45	60	103.4

Model No*	Frame Size	Heavy Duty					Normal Duty				
		Rated Current (A)	Motor Shaft Power		Peak Current Open Loop (A)	Peak Current RFC (A)	Rated Current (A)	Motor Shaft Power		Peak Current (A)	
			(kW)	(HP)				(kW)	(HP)		
M70x-07401000A	7	100	45	75	155.6	200	112	55	75	123.2	
M70x-08401340A	8	134	55	100	208.4	268	155	75	100	170.5	
M70x-08401570A	8	157	75	125	244.2	314	184	90	125	202.4	
M70x-09402000A/E	9	200	90	150	272.2	350	221	110	150	243.1	
M70x-09402240A/E	9	224	110	150	304.9	392	266	132	200	292.6	
M70x-10402700E	10	270	132	200	367.5	472.5	320	160	250	352	
M70x-10403200E	10	320	160	250	435.6	560	361	200	300	397.1	
M70x-11403770E	11	377	185	300	513.1	659.75	437	225	350	480.7	
M70x-11404170E	11	417	200	350	567.6	729.75	487	250	400	535.7	
M70x-11404640E	11	464	250	400	631.6	812	507	315	450	557.7	
<b>575 V (500 - 575 V ± 10 %)</b>											
M70x-05500030A	5	3	1.5	2	4.7	6	3.9	2.2	3	4.29	
M70x-05500040A	5	4	2.2	3	6.2	8	6.1	4	5	6.71	
M70x-05500069A	5	6.9	4	5	10.7	13.8	10	5.5	7.5	11	
M70x-06500100A	6	10	5.5	7.5	15.6	20	12	7.5	10	13.2	
M70x-06500150A	6	15	7.5	10	23.3	30	17	11	15	18.7	
M70x-06500190A	6	19	11	15	29.6	38	22	15	20	24.2	
M70x-06500230A	6	23	15	20	35.8	46	27	18.5	25	29.7	
M70x-06500290A	6	29	18.5	25	45.1	58	34	22	30	37.4	
M70x-06500350A	6	35	22	30	54.4	70	43	30	40	47.3	
M70x-07500440A	7	44	30	40	68.4	88	53	45	50	58.3	
M70x-07500550A	7	55	37	50	85.6	110	73	55	60	80.3	
M70x-08500630A	8	63	45	60	98	126	86	75	75	94.6	
M70x-08500860A	8	86	55	75	133.8	172	108	90	100	118.8	
M70x-09501040A/E	9	104	75	100	141.6	182	125	110	125	137.5	
M70x-09501310A/E	9	131	90	125	178.3	229.25	150	110	150	165	
M70x-10501520E	10	152	110	150	206.9	266	200	130	200	220	
M70x-10501900E	10	190	132	200	258.6	332.5	200	150	200	220	
M70x-11502000E	11	200	150	200	272.2	350	248	175	250	272.8	
M70x-11502540E	11	254	185	250	345.7	444.5	288	225	300	316.8	
M70x-11502850E	11	285	225	300	387.9	498.75	315	250	350	346.5	

Model No*	Frame Size	Heavy Duty					Normal Duty			
		Rated Current (A)	Motor Shaft Power		Peak Current Open Loop (A)	Peak Current RFC (A)	Rated Current (A)	Motor Shaft Power		Peak Current (A)
			(kW)	(HP)				(kW)	(HP)	
<b>690 V (500 - 690 V ± 10 %)</b>										
M70x-07600190A	7	19	15	20	29.6	38	23	18.5	25	25.3
M70x-07600240A	7	24	18.5	25	37.3	48	30	22	30	33
M70x-07600290A	7	29	22	30	45.1	58	36	30	40	39.6
M70x-07600380A	7	38	30	40	59.1	76	46	37	50	50.6
M70x-07600440A	7	44	37	50	68.4	88	52	45	60	57.2
M70x-07600540A	7	54	45	60	84	108	73	55	75	80.3
M70x-08600630A	8	63	55	75	98	126	86	75	100	94.6
M70x-08600860A	8	86	75	100	133.8	172	108	90	125	118.8
M70x-09601040A/E	9	104	90	125	141.6	182	125	110	150	137.5
M70x-09601310A/E	9	131	110	150	178.3	229.25	155	132	175	170.5
M70x-10601500E	10	150	132	175	204.2	262.5	172	160	200	189.2
M70x-10601780E	10	178	160	200	242.3	311.5	197	185	250	216.7
M70x-11602100E	11	210	185	250	285.8	367.5	225	200	250	247.5
M70x-11602380E	11	238	200	250	323.9	416.5	275	250	300	302.5
M70x-11602630E	11	263	250	300	358	460.25	305	315	400	335.5

\* x = 0, 1 or 2

# UNIDRIVE M600

# OPEN-LOOP

# CONTROL DRIVE

0.75 kW – 2.8 MW (1.0 - 4,200 hp) 200 V | 400 V | 575 V | 690 V

**High performance drive for induction and sensorless control of permanent magnet motors.**

Unidrive M600 is the perfect choice for applications that require high performance open-loop control of induction or permanent magnet motors.

SI-Encoder option modules are available for applications that require more precise closed-loop velocity and digital lock/frequency following of induction motors.

## Key Benefits:

- Energy savings
- Minimise downtime and system set-up time with advanced keypad options
- Reduced system costs with direct integration
- Improve throughput with advanced open-loop motor control algorithms
- Conform to safety standards, maximise uptime and reduce costs by direct safety system integration





# KEY FUNCTIONS

Function		Function	
Jog	✓	Supply loss detection	✓
Bi-polar reference	✓	Low DC link operation	✓
Pre-set speeds	8	Analogue input control	✓
Preset timer	✓	Analogue output control	✓
Skip frequencies	3	Temperature monitoring	✓
Skip frequency dead bands	✓	Digital input control	✓
Local/Remote	✓	Digital output control	✓
S-Ramp	✓	Relay control	✓
Acceleration Rates	8	Mechanical Brake Controller	✓
Deceleration Rates	8	Keypad button assignment	✓
Torque reference	✓	Motorised pot	✓
Control mode: Linear V/f	✓	Logic function control	✓
Control mode: Open-loop vector	✓	Timer function control	✓
Control mode: Quadratic V/f	✓	Limit switch control	✓
Stator resistance compensation	✓	Variable selector	✓
Slip compensation	✓	PID Control	✓
Sensorless control of induction motors	✓	Energy meter	✓
Sensorless control of permanent magnet motors	✓	Trip time stamping (using real-time clock , if available)	✓
Auto-tune static (including permanent magnet motors)	✓	Trip logging	8
Auto-tune rotating	✓	Run time log	✓
Catch a spinning motor	✓	Control word control	✓
Stop mode: Ramp	✓	Auto reset	✓
Stop mode: Coast	✓	Cloning	✓
Stop mode: Fast Ramp	✓	On-board PLC	16kb
DC injection braking	✓	Additional Application parameters	148
Programmable braking	✓	Second motor set-up	✓
Motor Pre-heat control	✓	Speed feedback via options	✓

# SPECIFICATION

Unidrive M600	
Items supplied with the drive	Control Getting Started Guide, Power Installation Guide, Safety Information, Quality Certificate, Control signal connectors, 24V power supply connector (frames 6 to 11), Grounding bracket, Surface mounting brackets, DC connection grommets (frames 3 to 6), Supply and motor connectors (frames 3 to 5), Nuts for supply and motor terminals (frames 6 to 11)
Storage temperature	-40°C to 55°C, -40°F to 131°F
Operating temperature without de-rate	-20°C to 40°C, -4°F to 104°F
Operating temperature with de-rate	40°C to 55°C, 104°F to 131°F
Supply requirements	Maximum supply imbalance: 2 % negative phase sequence (equivalent to 3 % voltage imbalance between phases). Input frequency 45 to 66Hz
Switching frequency range	2,3,4,6,8,12,16kHz (Factory default = 3kHz Open-loop/RFC-A, 6kHz RFC-S)
Approvals	CE (European Union), cUL Listed (USA and Canada), DNV (marine applications), RCM (Australia/ New Zealand), EAC (Russian Customs Union)
Product safety standard	EN61800-5-1
Functional safety (Single STO function)	Independently assessed by TÜV to IEC 61800-5-2 SIL 3 and EN ISO 13849-1 PL
Altitude	1000m – No de-rate. 1000m to 3000m - 1% de-rate/100m
Humidity	95% Non-condensing at 40 °C (104 °F)
Pollution	Degree 2. Dry, non-conducting pollution only
IP Rating	IP20 / NEMA1 / UL TYPE 1 (UL open class as standard, additional kit needed to achieve Type 1) IP65 / NEMA4 / UL TYPE 12 rating on the rear of drive when through panel mounted (Frames 3 to 8) IP55 / NEMA4 / UL TYPE 12 rating on the rear of drive when through panel mounted (Frames 9 to 11)
Vibration	Reference standard IEC60068-2-27, IEC60068-2-29 bump test, IEC60068-2-64 random vibration test, IEC60068-2-6, EN61800-5-1 sinusoidal vibration test. Tested to Environmental Category ENV3.
Mounting methods	Frame 3 to 11 – Surface mount via supplied mounting brackets or through-panel mount via optional mounting brackets Frame 3 to 5 – Tile mount via optional mounting brackets
Output frequency/speed range	599Hz (Open-loop), 560Hz (RFC-A, RFC-S)
Braking	In-built braking transistor, optional internal resistor on frame 3 to 5 or external resistor (all frames)
Operating modes	Open-loop: Open-loop vector, fixed V/F, quadratic V/F RFC-A: Rotor Flux Control for Asynchronous induction motors, without position feedback, or with position feedback from optional SI-Encoder or SI-Universal Encoder. RFC-S: Rotor Flux Control for Synchronous permanent magnet motors, without position feedback Regen: Regenerative front end for four quadrant operation

<b>Overload capability</b>	<p>Normal duty (cold): Open-loop – 110% for 165s, RFC – 110% for 165s</p> <p>Heavy duty (cold): Open-loop – 150% for 60s, RFC – 200% for 28s (size 8 and below)</p> <p>Heavy duty (cold): Open-loop – 136% for 81s, RFC – 175% for 42s (size 9, 10, 11)</p>
<b>Overvoltage category</b>	Evaluated for OVC III.
<b>Corrosive environments</b>	<p>Concentrations of corrosive gases must not exceed the levels given in: Table A2 of EN 50178:1998, Class 3C2 of IEC 60721-3-3</p> <p>This corresponds to the levels typical of urban areas with industrial activities and/or heavy traffic, but not in the immediate neighbourhood of industrial sources with chemical emissions.</p>
<b>Immunity Compliance</b>	<p>IEC61800-3, IEC 61000-4-2, IEC 61000-4-3, IEC61000-4-4, IEC61000-4-5, IEC61000-4-6, IEC61000-4-8, IEC61000-4-11, IEC61000-6-1, IEC 61000-6-2.</p>
<b>Emission compliance</b>	<p>Capable of meeting the requirements of Equipment Category C3 without external filters or line reactors. Capable of meeting the requirements of Equipment Category C2 when installed with the recommended filters and line reactors.</p> <p>IEC61800-3, EC61000-6-4, EN61000-3-2, EN61000-3-12, EN61000-3-3, EN12015</p>
<b>Cooling</b>	Forced cooled
<b>Safe Torque Off</b>	Single STO channel. SIL 3
<b>Communications</b>	<p>Onboard: RS485, Modbus RTU</p> <p>SI Options: EtherCAT, PROFIBUS, Ethernet, DeviceNET, CANopen, PROFINET, POWERLINK</p>
<b>Control I/O</b>	<p>3 x Analogue input (1 x differential, 2 x single ended), 2 x Analogue output, 3 x Digital I/O programmable, 3 x Digital input (including 2 x high speed – 250µs), 1 x NO relay 250Vac Max., 6 x 0V common, 1 x 24V supply input, 1 x 24V user output, 1 x 10V user output, 1 x Safe Torque Off input. Additional I/O available with SI-I/O option module.</p>
<b>Resolution and Accuracy</b>	<p>Frequency/speed accuracy: 0.01% (preset speed)</p> <p>Open loop resolution – Preset reference: 0.1 Hz, Precision reference: 0.001 Hz</p> <p>Closed loop resolution: Preset reference: 0.1 rpm, Precision reference: 0.001 rpm</p> <p>Analog input 1: 11 bit plus sign, Analog input 2: 11 bit plus sign</p> <p>Current resolution: 10 bit plus sign, Current accuracy: typical 2 %</p>
<b>On-Board user program capability</b>	16kB, IEC 61131-3 compliant
<b>Keypad</b>	<p>Optional LCD keypad with or without real-time clock</p> <p>Optional Remote LCD keypad with or without real-time clock</p>
<b>Parameter backup and cloning</b>	Smartcard and SD card (using SD card adapter)
<b>PC Tools</b>	'Connect' commissioning and cloning tool including CT Oscilloscope, Machine Control Studio for On-board PLC programming.
<b>Warranty</b>	26 months
<b>Supported options</b>	<p>RTC Remote Keypad, KI-485 Adapter, HMI, RS485-Communications lead, SI-EtherCAT, SI-PROFIBUS, SI-Ethernet, SI-DeviceNET, SI-CANopen, SI-PROFINET, SI-I/O, SI-Encoder (speed feedback), SI-Universal Encoder (speed feedback), SI-Safety, Remote I/O, Smartcard, SD card (using SD card adapter)</p>
<b>Accessories</b>	Through-hole IP65 mounting kit, UL type conduit kits, SP Retrofit mounting brackets, External EMC filters, Grounding bracket (supplied with the drive)

# DIMENSIONS

Frame Size	Overall Dimensions						Mounting Dimensions				Mounting Hole Diameter		Weight	
	mm			in			mm		in		mm	in	kg	lb
	H**	W	D	H**	W	D	H	W	H	W				
3	365	83	200	14.37	3.27	7.87	370	73	14.57	2.87	5	0.2	4.0*	8.8*
4	365	124	200	14.37	4.88	7.87	375	106	14.76	4.17	6	0.23	6.5	14.3
5	365	143	200	14.37	5.63	7.87	375	106	14.76	4.17	6.5	0.26	7.4	16.3
6	365	210	227	14.37	8.27	8.94	378	196	14.88	7.72	7	0.28	14	30.9
7	508	270	280	20	10.63	11.02	538	220	21.18	8.66	9	0.35	28	61.7
8	753	310	290	29.65	12.21	11.42	884	259	30.87	10.2	9	0.35	52	114.6
9E/10E	1010	310	290	39.7	12.21	11.42	1051	259	41.38	10.2	9	0.35	46	101.4
9A	1049	310	290	41.3	12.21	11.42	1090	259	42.91	10.2	9	0.35	66.5	146.6
11E	1190	310	312	46.9	12.2	48.9	1222	259	48.11	10.2	9	0.35	63	138.9



\* 034300078, 034300100 weigh 4.5 kg (9.9 lbs), all other variants weigh 4.0 kg (8.8 lbs)

\*\* Overall dimensions do not include removable mounting brackets

# CONNECTIONS

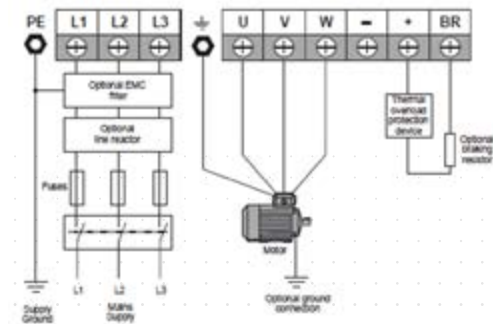

Typical Power Connections

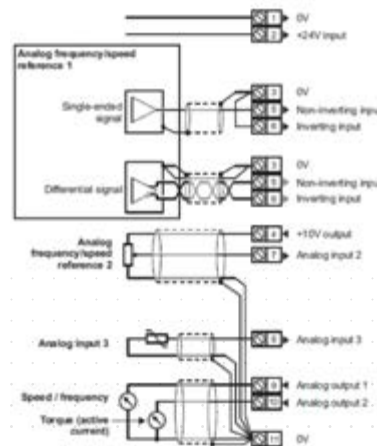

Default Control Connections

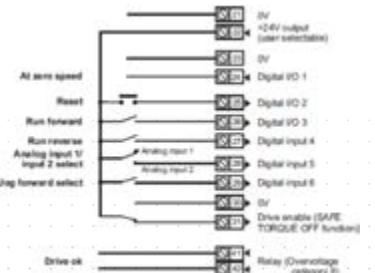

NOTE: DC- terminal is not accessible on frame 9E to 11E

# PART NUMBERS

**M600**  
Model:  
M600

**03**  
Frame Size  
3 to 11

**4**  
Voltage Rating:  
2 = 200V (200V-240 +/-10%)  
4 = 400V (380V-480V +/-10%)  
5 = 575V (500V-575V +/-10%)  
6 = 690V (500V-690V +/-10%)

**00078**  
Heavy Duty Current  
Rating x 10

**A**  
Drive Format  
A = AC in AC out, internal choke\*  
D = DC in AC out, inverter  
C = AC in DC out, rectifier  
E = AC in AC out, external choke  
T = AC in AC out, 12P rectifier plus inverter

\*Frame 9 and below

# MODEL NUMBER AND RATINGS

Model No*	Frame Size	Heavy Duty					Normal Duty			
		Rated Current (A)	Motor Shaft Power		Peak Current Open Loop (A)	Peak Current RFC (A)	Rated Current (A)	Motor Shaft Power		Peak Current (A)
			(kW)	(HP)				(kW)	(HP)	
<b>200 V (200 - 240 V ± 10 %)</b>										
M600-03200050A	3	5	0.75	1	7.8	10	6.6	1.1	1.5	7.26
M600-03200066A	3	6.6	1.1	1.5	10.3	13.2	8	1.5	2	8.8
M600-03200080A	3	8	1.5	2	12.4	16	11	2.2	3	12.1
M600-03200106A	3	10.6	2.2	3	16.5	21.2	12.7	3	3	13.97
M600-03200160A	3	16	4	5	37.3	48	16	4	5	48
M600-04200137A	4	13.7	3	3	21.3	27.4	18	4	5	19.8
M600-04200185A	4	18.5	4	5	28.8	37	25	5.5	7.5	27.5
M600-05200250A	5	25	5.5	7.5	38.9	50	30	7.5	10	33

Model No*	Frame Size	Heavy Duty					Normal Duty				
		Rated Current (A)	Motor Shaft Power		Peak Current Open Loop (A)	Peak Current RFC (A)	Rated Current (A)	Motor Shaft Power		Peak Current (A)	
			(kW)	(HP)				(kW)	(HP)		
M600-06200330A	6	33	7.5	10	51.3	66	50	11	15	55	
M600-06200440A	6	44	11	15	68.4	88	58	15	20	63.8	
M600-07200610A	7	61	15	20	94.9	122	75	18.5	25	82.5	
M600-07200750A	7	75	18.5	25	116.7	150	94	22	30	103.4	
M600-07200800A	7	80	22	30	124.5	166	80	30	40	128.7	
M600-07200830A	7	83	22	30	129.1	166	117	30	40	128.7	
M600-08201160A	8	116	30	40	180.4	232	149	37	50	163.9	
M600-08201320A	8	132	37	50	205.3	264	180	45	60	198	
M600-09201760A/E	9	176	45	60	239.6	308	216	55	75	237.6	
M600-09202190A/E	9	219	55	75	298.1	383.25	266	75	100	292.6	
M600-10202830E	10	283	75	100	385.2	495.25	325	90	125	357.5	
M600-10203000E	10	300	90	125	408.3	525	360	110	150	396	
<b>400 V (380 - 480 V ± 10 %)</b>											
M600-03400025A	3	2.5	0.75	1	3.9	5	3.4	1.1	1.5	3.74	
M600-03400031A	3	3.1	1.1	1.5	4.8	6.2	4.5	1.5	2	4.95	
M600-03400045A	3	4.5	1.5	2	7	9	6.2	2.2	3	6.82	
M600-03400062A	3	6.2	2.2	3	9.6	12.4	7.7	3	5	8.47	
M600-03400078A	3	7.8	3	5	12.1	15.6	10.4	4	5	11.44	
M600-03400100A	3	10	4	5	15.6	20	12.3	5.5	7.5	13.53	
M600-03400135A	3	13.5	5.5	7.5	31.5	40.5	13.5	5.5	7.5	40.5	
M600-03400160A	3	16	5.5	10	37.3	48	16	5.5	10	48	
M600-04400150A	4	15	5.5	10	23.3	30	18.5	7.5	10	20.35	
M600-04400172A	4	17.2	7.5	10	26.8	34.4	24	11	15	26.4	
M600-05400220A	5	22	9	15	34.2	44	27	11	20	29.7	
M600-05400270A	5	27	11	20	42	54	30	15	20	33	
M600-05400300A	5	30	15	20	46.7	60	31	15	20	34.1	
M600-06400350A	6	35	15	25	54.4	70	38	18.5	25	41.8	
M600-06400420A	6	42	18.5	30	65.3	84	48	22	30	52.8	
M600-06400470A	6	47	22	30	73.1	94	63	30	40	69.3	

Model No*	Frame Size	Heavy Duty					Normal Duty			
		Rated Current (A)	Motor Shaft Power		Peak Current Open Loop (A)	Peak Current RFC (A)	Rated Current (A)	Motor Shaft Power		Peak Current (A)
			(kW)	(HP)				(kW)	(HP)	
M600-07400660A	7	66	30	50	102.7	132	79	37	50	86.9
M600-07400770A	7	77	37	60	119.8	154	94	45	60	103.4
M600-07401000A	7	100	45	75	155.6	200	112	55	75	123.2
M600-08401340A	8	134	55	100	208.4	268	155	75	100	170.5
M600-08401570A	8	157	75	125	244.2	314	184	90	125	202.4
M600-09402000A/E	9	200	90	150	272.2	350	221	110	150	243.1
M600-09402240A/E	9	224	110	150	304.9	392	266	132	200	292.6
M600-10402700E	10	270	132	200	367.5	472.5	320	160	250	352
M600-10403200E	10	320	160	250	435.6	560	361	200	300	397.1
M600-11403770E	11	377	185	300	513.1	659.75	437	225	350	480.7
M600-11404170E	11	417	200	350	567.6	729.75	487	250	400	535.7
M600-11404640E	11	464	250	400	631.6	812	507	315	450	557.7
<b>575 V (500 - 575 V ± 10 %)</b>										
M600-05500030A	5	3	1.5	2	4.7	6	3.9	2.2	3	4.29
M600-05500040A	5	4	2.2	3	6.2	8	6.1	4	5	6.71
M600-05500069A	5	6.9	4	5	10.7	13.8	10	5.5	7.5	11
M600-06500100A	6	10	5.5	7.5	15.6	20	12	7.5	10	13.2
M600-06500150A	6	15	7.5	10	23.3	30	17	11	15	18.7
M600-06500190A	6	19	11	15	29.6	38	22	15	20	24.2
M600-06500230A	6	23	15	20	35.8	46	27	18.5	25	29.7
M600-06500290A	6	29	18.5	25	45.1	58	34	22	30	37.4
M600-06500350A	6	35	22	30	54.4	70	43	30	40	47.3
M600-07500440A	7	44	30	40	68.4	88	53	45	50	58.3
M600-07500550A	7	55	37	50	85.6	110	73	55	60	80.3
M600-08500630A	8	63	45	60	98	126	86	75	75	94.6
M600-08500860A	8	86	55	75	133.8	172	108	90	100	118.8
M600-09501040A/E	9	104	75	100	141.6	182	125	110	125	137.5
M600-09501310A/E	9	131	90	125	178.3	229.25	150	110	150	165
M600-10501520E	10	152	110	150	206.9	266	200	130	200	220

Model No*	Frame Size	Heavy Duty					Normal Duty				
		Rated Current (A)	Motor Shaft Power		Peak Current Open Loop (A)	Peak Current RFC (A)	Rated Current (A)	Motor Shaft Power		Peak Current (A)	
			(kW)	(HP)				(kW)	(HP)		
M600-10501900E	10	190	132	200	258.6	332.5	200	150	200	220	
M600-11502000E	11	200	150	200	272.2	350	248	175	250	272.8	
M600-11502540E	11	254	185	250	345.7	444.5	288	225	300	316.8	
M600-11502850E	11	285	225	300	387.9	498.75	315	250	350	346.5	
<b>690 V (500 - 690 V ± 10 %)</b>											
M600-07600190A	7	19	15	20	29.6	38	23	18.5	25	25.3	
M600-07600240A	7	24	18.5	25	37.3	48	30	22	30	33	
M600-07600290A	7	29	22	30	45.1	58	36	30	40	39.6	
M600-07600380A	7	38	30	40	59.1	76	46	37	50	50.6	
M600-07600440A	7	44	37	50	68.4	88	52	45	60	57.2	
M600-07600540A	7	54	45	60	84	108	73	55	75	80.3	
M600-08600630A	8	63	55	75	98	126	86	75	100	94.6	
M600-08600860A	8	86	75	100	133.8	172	108	90	125	118.8	
M600-09601040A/E	9	104	90	125	141.6	182	125	110	150	137.5	
M600-09601310A/E	9	131	110	150	178.3	229.25	155	132	175	170.5	
M600-10601500E	10	150	132	175	204.2	262.5	172	160	200	189.2	
M600-10601780E	10	178	160	200	242.3	311.5	197	185	250	216.7	
M600-11602100E	11	210	185	250	285.8	367.5	225	200	250	247.5	
M600-11602380E	11	238	200	250	323.9	416.5	275	250	300	302.5	
M600-11602630E	11	263	250	300	358	460.25	305	315	400	335.5	

## Documentation & Downloads

Product documentation and PC tools available for download from:  
[www.controltechniques.com/support](http://www.controltechniques.com/support)

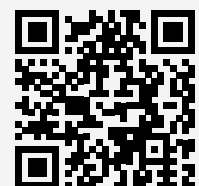





# UNIDRIVE M SERIES HIGH POWER MODULAR AC DRIVES

M600 | M700 | M701 | M702 | F600 | H300

**Unidrive M's modular offering provides a flexible method of building compact, reliable high-power solutions.**

**Paralleled together, Unidrive M can control asynchronous and permanent magnet motors in systems up to 2.8 MW (4,200 hp). The frame 11 is a 250 kW (400 hp) module that allows system builders to create high power solutions with the smallest number of components, keeping both footprint and costs to a minimum.**

Unidrive M differentiates itself on performance with extremely fast current control algorithms and high switching frequencies. Active Front End (AFE) solutions deliver unparalleled torque precision and power quality.

The Unidrive M modules can be paralleled into a wide range of flexible solutions to solve all system needs including Active Front End and multi-pulse rectifier configurations. They can be controlled by M600, M700, M701 and M702 controllers.





**A, E, T**



**D**



**RECT..A, RECT..T**



**Master Control,  
Standard Control**



**Follower Control**

Format	
A	AC in AC out module with integrated rectifier and line choke. Available in frame size 9 and can be paralleled up to 1.9 MW (Unidrive SPMA replacement)
E	AC in AC out module with integrated rectifier. Available in frame sizes 9, 10 & 11 and can be paralleled up to 2.8 MW
T	AC in AC out module with 12 pulse integrated rectifier. Available in frame size 9, 10 & 11 and can be paralleled up to 2.8 MW
D	DC in AC out module. Available in frame size 9, 10 & 11 and can be paralleled up to 2.8 MW (Unidrive SPMD replacement)
RECT..A	AC in DC out rectifier 6 pulse module (Unidrive SPMC replacement)
RECT..T	AC in DC out rectifier 12 pulse module (Unidrive SPMC2 replacement)
Standard Control	M700, M701, M702, M600 controller for single module systems
Master Control	M700, M701, M702, M600 master controller for systems with more than one module
Follower Control	Follower controller for all paralleled modules

# DIMENSIONS

## INTEGRATED INVERTER & RECTIFIER



### Modular Drives

Frame size		9A	9E   9T	10E   10T	11E   11T
Frame sizes available	M600   M700	•	•	•	•
Dimensions (H x W x D)	mm	1049 x 310 x 290	1010 x 310 x 290	1010 x 310 x 290	1190 x 310 x 312
	in	41.3 x 12.2 x 11.4	39.7 x 12.2 x 11.4	39.7 x 12.2 x 11.4	46.9 x 12.2 x 12.3
Weight	kg (lb)	66.5 (146.6)	46 (101.4)   60 (132.3)	46 (101.4)   60 (132.3)	63 (138.9)   65 (143.3)
AC line choke	Internal	•			
	External		•	•	•

# MODEL RATINGS

Frame size		9A	9E   9T	10E   10T	11E   11T
Max continuous heavy duty kW rating / A rating	@ 200 V	45 kW – 55 kW (60 hp – 75 hp)	45 kW – 55 kW (60 hp – 75 hp)	75 kW – 90 kW (100 hp – 125 hp)	N/A
	@ 400 V	90 kW – 110 kW (125 hp – 150 hp)	90 kW – 110 kW (150hp)	132 kW – 160 kW (200 hp – 250 hp)	185 kW – 250 kW (300 hp – 400 hp)
	@ 575 V	75 kW – 90 kW (100 hp – 125 hp)	75 kW – 90 kW (100 hp – 125 hp)	110 kW – 132 kW (150 hp – 200 hp)	150 kW – 225 kW (200 hp – 300 hp)
	@ 690 V	90 kW – 110 kW (125 hp – 150 hp)	90 kW – 110 kW (125 hp – 150 hp)	132 kW – 160 kW (175 hp – 200 hp)	185 kW – 250 kW (250 hp – 300 hp)

Modular ratings up to 2.8 MW (4,200 hp) through parallel connected inverters.

**DC-AC INVERTER**

**RECTIFIER**



9D	10D	11D	10A	11A	11T
•	•	•			
714 x 310 x 290	714 x 310 x 290	804 x 310 x 312	296 x 310 x 290	383 x 310 x 290	383 x 310 x 290
28.11 x 12.2 x 11.4	28.11 x 12.2 x 11.4	31.7 x 12.2 x 12.3	11.7 x 12.2 x 11.4	15.1 x 12.2 x 11.4	15.1 x 12.2 x 11.4
34 (75)	34 (75)	42 (92.6)	12 (26.5)	21 (46.3)	23 (50.7)

			•	•	•
--	--	--	---	---	---

9D	10D	11D	10A	11A	11T
45 kW - 55 kW (60 hp - 75 hp)	75 kW - 90 kW (100 hp - 125 hp)	N/A	413 A*	N/A	N/A
90 kW - 110 kW (150hp)	132 kW - 160 kW (200 hp - 250 hp)	185 kW - 250 kW (300 hp - 400 hp)	455 A*	689 A*	2 x 400 A*
75 kW - 90 kW (100 hp - 125 hp)	110 kW - 132 kW (150 hp - 200 hp)	150 kW - 225 kW (200 hp - 300 hp)	246 A*	387 A*	
90 kW - 110 kW (125 hp - 150 hp)	132 kW - 160 kW (175 hp - 200 hp)	185 kW - 250 kW (250 hp - 300 hp)	251 A*	411 A*	2 x 380 A*

\* Maximum DC output current

# ORDERING INFORMATION

Vac ±10%	M600 M700 M701 M702	Order Code Frame & Format Identifiers	Heavy Duty					Normal Duty			Peak	Rectifier for Modular '..D' Inverters	Input Choke		Output Choke		
			Cont. Max	Motor Shaft Power		Peak Open Loop	Peak Rotor Flux Control	Cont. Max	Motor Shaft Power				RECT-..A/T	Single	Dual	Single	Dual
			A	kW	hp	A	A	A	kW	hp			A				
200/240	'-09201760'	09..A/E/T/D	176	45	60	264	308	216	55	75	238	'-10204100A'	INL401	INL411	OTL401	OTL411	
	'-09202190'	09..A/E/T/D	219	55	75	328	383	266	75	100	293				OTL402	OTL412	
	'-10202830'	10..E/T/D	283	75	100	424	495	325	90	125	358		INL402	INL412	OTL403	OTL413	
	'-10203000'	10..E/T/D	300	90	125	450	525	360	110	150	396				OTL404	OTL414	
380/480	'-09402000'	09..A/E/T/D	200*	90	150	300	350	221	110	150	243	'-10404520A'	INL401	INL411	OTL401	OTL411	
	'-09402240'	09..A/E/T/D	224*	110	150	336	392	266*	132	200	293				OTL402	OTL412	
	'-10402700'	10..E/T/D	270	132	200	405	472	320	160	250	352		INL402	INL412	OTL403	OTL413	
	'-10403200'	10..E/T/D	320*	160	250	480	560	361	200	300	397				OTL404	OTL414	
	'-11403770'	11..E/T/D	377*	185	300	566	659	437*	225	350	480		INL403L		OTL405		
	'-11404170'	11..E/T/D	417*	200	350	626	729	487*	250	400	535		INL403		OTL407		
	'-11404640'	11..E/T/D	464*	250	400	696	812	507*	280	450	558				OTL407		
500/575	'-09501040'	09..A/E/T/D	104	75	100	156	182	125	110	125	138	'-10502430A'	INL601	INL611	OTL601	OTL611	
	'-09501310'	09..A/E/T/D	131	90	125	196	229	150	110	150	165				OTL602	OTL612	
	'-10501520'	10..E/T/D	152	110	150	228	266	200	130	200	220		INL602	INL612	OTL603	OTL613	
	'-10501900'	10..E/T/D	190	132	200	285	332	200	150	200	220				OTL604	OTL614	
	'-11502000'	11..E/T/D	200*	150	200	300	350	248*	185	250	273				OTL605		
	'-11502540'	11..E/T/D	254*	185	250	381	444	288*	225	300	317		INL603		OTL607		
	'-11502850'	11..E/T/D	285*	225	300	428	498	315*	250	350	346				OTL607		
500/690	'-09601040'	09..A/E/T/D	104	90	125	156	182	125	110	150	138	'-10602480A'	INL601	INL611	OTL601	OTL611	
	'-09601310'	09..A/E/T/D	131	110	150	196	229	155	132	175	171				OTL602	OTL612	
	'-10601500'	10..E/T/D	150	132	175	225	262	172	160	200	189		INL602	INL612	OTL603	OTL613	
	'-10601780'	10..E/T/D	178	160	200	267	311	197	185	250	217				OTL604	OTL614	
	'-11602100'	11..E/T/D	210*	185	250	315	367	225*	200	250	248				OTL605		
	'-11602380'	11..E/T/D	238*	200	250	357	416	275*	250	300	303		INL603		OTL607		
	'-11602630'	11..E/T/D	263*	250	300	394	460	305*	280	400	335				OTL607		

**Notes:**

\* At 2 kHz switching frequency

For paralleling, a 5% derating should be applied. For ratings at F 'switching frequency' > 3 kHz (or 2 kHz for F11) refer to User Guide

Refer to electrical specification of the part number (page 91, digits 6-13)

# PART NUMBERS

Range & Derivative	Electrical Specification	Drive Format	Documentation	Customer Code	Configure to Order Optional Build
Digit 1 2 3 4 5 <b>Mxxx-</b>	Frame & Volts & Current 6 7 8 9 10 11 12 13 <b>10 4 03200</b>	Power Control Spare 14 15 16 <b>A 1 0</b>	17 <b>1</b>	18 19 <b>00</b>	20 21 22 23 24 <b>A B 1 0 0</b>

**Frame**

**Volts:**

- 2 = 200 V
- 4 = 400 V
- 5 = 575 V
- 6 = 690 V

**Current Rating:**

- M100 to M702:  
Heavy Duty rating x 10
- RECT.T (twin rectifier):  
2 x Heavy Duty rating

**Documentation:**

- 0 = Supplied Separately
- 1 = English or Multilingual
- 2 = French
- 3 = Italian
- 4 = German
- 5 = Spanish

**Brake Transistor:**

- B = Brake
- N = N\*

**IP / NEMA Rating:**

- 1 = IP20 / NEMA 1

**Keypad:**

- 0 = No Keypad on M6xx and M7xx

**Drive Range: Derivative Description:**

M600-	Will control sensorless permanent magnet and open loop induction motors
M700-	Ethernet and 1 x STO
M701-	Modbus and 1 x STO
M702-	Ethernet and 2 x STO
M000-	Unassigned power – user fit control
RECT-	Rectifier for modular range
HS70-	High speed version of M700
HS71-	High speed version of M701
HS72-	High speed version of M702

**Control Module Range for Unassigned Modular Drives**

Mxxx-STANDARD011100A0100
Mxxx-MASTER00011100A0100
M000-FOLLOWER011100A0100

Power Ident.	Control Ident.	Description	Frame	Power Range (Heavy Duty)	Access to DC bus
A	U	Integrated Rectifier and Inverter Internal Line Choke	9	90 to 110 kW 125 to 150 hp Up to 1.9 MW / 2,800 hp in Parallel	Yes
M000-	E	Integrated Single Rectifier and Inverter External Line Choke	09, 10, 11	90 to 250 kW 125 to 400 hp Up to 2.8 MW / 4,200 hp in Parallel	No
	T	Integrated Twin Rectifier and Inverter External Line Choke			
	D	DC to AC Inverter	09, 10, 11		Yes
RECT-	A	AC to DC Single Rectifier	10, 11	90 to 250 kW / 125 to 400 hp	Yes
	T	AC to DC Twin Rectifier	10, 11		

\*Only available for Frame size 9 and up

## UNIDRIVE M400

# MINIMISE DOWNTIME & SYSTEM SETUP

0.25 - 132 kW (0.33 - 200 hp) 100 V | 200 V | 400 V | 575 V | 690 V

**Optimised throughput, open automation systems, maximum ease of use.**

**Unidrive M400 is exceptional at combining the ease of use of our general purpose range with the capabilities of our high performance Unidrive M Series.**

The removable keypad with a real-text display makes it ideal for users who require extra diagnostic help when setting up parameters. Add in an impressive I/O count, dual Safe Torque Off (STO) and integrated PLC, all of which contribute to making Unidrive M400 an extremely capable drive.

Unidrive M400 combines the latest microprocessor technology with unique motor control algorithms to give maximum stability of induction motors at all powers. Current loop update rates up to 125  $\mu$ s and complementary intelligent control features ensure that machine throughput and energy efficiency are maximised in all industrial applications.

### Key Benefits:

- Reduced system costs with direct integration
- Fast and easy access for commissioning, monitoring and diagnostics
- Flexible communications
- Energy efficiency
- High performance open-loop control





# KEY FUNCTIONS

Function		Function	
Jog	✓	Supply loss detection	✓
Bi-polar reference	✓	Low DC link operation	✓
Pre-set speeds	8	Analogue input control	✓
Pre-set timer	✓	Analogue output control	✓
Skip frequencies	3	Temperature monitoring	✓
Skip frequency dead bands	✓	Digital input control	✓
Local/Remote	✓	Digital output control	✓
S-Ramp	✓	Relay control	✓
Acceleration Rates	8	Mechanical Brake Controller	✓
Deceleration Rates	8	Keypad button assignment	✓
Pulse train frequency reference	0 - 100kHz	Motorised pot	✓
Torque reference	✓	Logic function control	✓
Remote keypad with real time clock	✓	Timer function control	✓
Control mode: open loop vector mode	✓	Stop mode: Ramp	✓
Control mode: fixed V/F mode	✓	Stop mode: Coast	✓
Control mode: square V/F mode	✓	Stop mode: Fast Ramp	✓
Control mode: RFC-A mode	✓	PID Control	✓
On-board 'Scope function	✓	Limit switch control	✓
Stator resistance compensation	✓	Variable selector	✓
Slip compensation	✓	Energy meter	✓
Auto-tune static	✓	Trip time stamping	✓
Trip logging	✓	Run time log	✓
Auto-tune rotating	✓	Control word control	✓
Catch a spinning motor	✓	Auto reset	✓
DC injection braking	✓	Cloning	✓
Programmable braking	✓	On-board PLC	16kb
Motor Pre-heat control	✓	Additional Application parameters	65
Speed feedback via options	✓	Second motor set-up	✓

# SPECIFICATION

Unidrive M400	
Items supplied with the drive	Step-By-Step Guide, Safety Information, Grounding bracket (Frames 1 to 4), Surface mounting brackets (frame 5 to 9)
Storage temperature	-40°C to 60°C, -4°F to 140°F
Operating temperature without de-rate	-20°C to 40°C, -4°F to 140°F
Operating temperature with de-rate	40°C to 60°C, 104°F to 140°F Frames 1 to 4 40°C to 55°C, 104°F to 131°F Frames 5 to 9
Supply requirements	Maximum supply imbalance: 2 % negative phase sequence (equivalent to 3 % voltage imbalance between phases). Input frequency 45 to 66Hz
Switching frequency range	*0.66,*1,2,3,4,6,8,12,16kHz (Factory default = 3kHz)
Approvals	CE (European Union), cUL Listed (USA and Canada), DNV (marine applications), KC (Korea), RCM (Australia/ New Zealand), EAC (Russian Customs Union)
Product safety standard	EN61800-5-1
Functional safety (Dual STO function)	TuV
Altitude	1000m – No de-rate. 1000m to 3000m - 1% de-rate/100m
Humidity	95% Non-condensing
Pollution	Degree 2. Dry, non-conducting pollution only
IP Rating	IP20 – Pollution degree 2
Vibration	Reference standard IEC60068-2-27, IEC60068-2-29 bump test, IEC60068-2-64 random vibration test, IEC60068-2-6, EN61800-5-1 sinusoidal vibration test. Tested to Environmental Category ENV3.
Mounting methods	Frame 1 to 4 – Surface mount, DIN Rail or mounting holes Frame 5 to 9 – Surface mount or through-panel mount via mounting brackets
Output frequency/speed range	599Hz
Braking	In-built braking transistor, external resistor required.
Operating modes	Open-loop, RFC-A (enhanced open-loop performance)
Overload capability	Open-loop – 150% for 60s RFC-A 180% for 3s
Overvoltage category	Evaluated for OVC III.
Corrosive environments	Category C3 according to BS EN ISO 9223
Immunity Compliance	IEC61800-3, EN60800-6-2, IEC 61000-4-2, IEC 61000-4-3, IEC61000-4-4, IEC61000-4-5, IEC61000-4-6, IEC61000-4-8, IEC61000-4-11, IEC61000-6-1, IEC 61000-6-2.
Emission compliance	Capable of meeting the requirements of Equipment Category C3 without external filters or line reactors. Capable of meeting the requirements of Equipment Category C2 when installed with the recommended filters and line reactors. IEC61800-3, IEC61000-6-4, EN61000-3-2, EN61000-3-12, EN61000-3-3, EN12015
Cooling	Forced cooled
Safe Torque off	Dual STO channels.
Communications**	RS485, EtherCAT, PROFIBUS, Ethernet, DeviceNET, CANopen, PROFINET, POWERLINK

Control I/O	2 x analogue input, 2 x analog outputs, 2 x digital I/O programmable, 6 x digital inputs, 2 x digital outputs, 1 x frequency input, 1 x AB encoder input, 1 x PWM/frequency output, 1 x motor thermistor input, 1 x NO relay 250Vac Max., 2 x 0V common, 2 x 24V user output, 1 x 10V user output. Additional I/O available with SI-I/O option module.
Accuracy	Frequency 0.02%, Analogue input 1: 11 bit plus sign, Analogue input 2: 11 bit. Current typical 2%.
On-Board user program capability	16kB
Keypad	Fixed LED keypad, Remote keypad with Real-time clock available as option
PC Tools	'Connect' commissioning and cloning tool including CT Oscilloscope, Machine Control Studio for On-board PLC programming.
Warranty	2 years
Supported options	AI-Back-up Adaptor, SI-SMART Adaptor, AI-485 & 24V Back-up Adaptor, RTC Remote Keypad, HMI, RS485-Communications lead, SI-EtherCAT, SI-PROFIBUS, SI-Ethernet, SI-DeviceNET, SI-CANopen, SI-PROFINET, SI-I/O, SI-Encoder (speed feedback), Remote I/O.
Accessories	Through-hole IP65 mounting kits (frame 5 to 9), UL type conduit kits, SK Retrofit mounting brackets, External EMC filters (standard and low leakage up to and including frame 4), Grounding bracket (supplied with the drive)

\*Frames 1 to 4

\*\*Available with SI-options

# DIMENSIONS

Frame Size	Overall Dimensions						Mounting Dimensions				Mounting Hole Diameter		Weight	
	mm			in			mm		in		mm	in	kg	lb
	H	W	D	H	W	D	H	W	H	W				
1	160	75	130	6.3	2.95	5.1	143	53	5.7	2.08	5	0.2	0.75	1.65
2	205	75	150	8.07	2.95	5.9	194	55	7.63	2.17	5	0.2	1.3	3
3	226	90	160	8.9	3.54	6.3	215	70.7	8.46	2.8	5	0.2	1.5	3.3
4	277	115	175	10.9	4.5	6.9	265	86	10.43	3.4	6	0.23	3.13	6.9
5	391	143	200	15.39	5.63	7.87	375	106	14.76	4.17	6.5	0.26	7.4	16.3
6	291	210	227	15.39	8.27	8.94	378	196	14.88	7.72	7	0.28	14	30.9
7	557	270	280	21.93	10.63	11.02	538	220	21.18	8.66	9	0.35	28	61.7
8	804	310	290	31.65	12.21	11.42	884	259	30.87	10.2	9	0.35	52	114.6
9A	1069	310	290	42.09	12.21	11.42	1051	259	41.38	10.2	9	0.35	46	101.4
9E	1108	310	290	43.62	12.21	11.42	1090	259	42.91	10.2	9	0.35	66.5	146.6



# CONNECTIONS

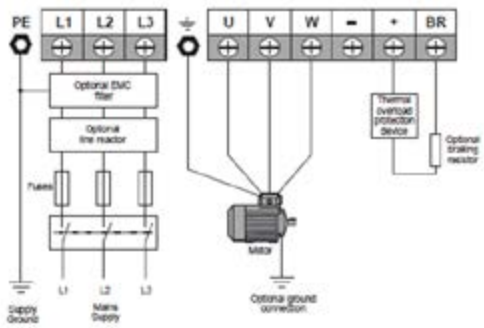

Typical Power Connections

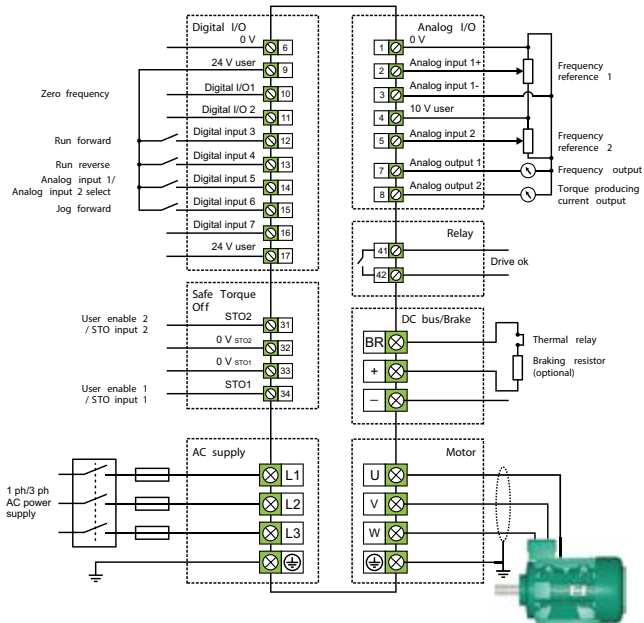

Default Control Connections

# PART NUMBERS

<p><b>M400</b></p> <p>.....</p> <p><b>Model:</b> M400</p>	<p><b>03</b></p> <p>.....</p> <p><b>Frame Size</b> 1 to 9</p>	<p><b>4</b></p> <p>.....</p> <p><b>Voltage Rating:</b></p> <p>1 = 100 V 2 = 200 V 4 = 400 V 5 = 575 V 6 = 690 V</p>	<p><b>00073</b></p> <p>.....</p> <p><b>Heavy Duty Current</b> Rating x 10</p>	<p><b>A</b></p> <p>.....</p> <p><b>Drive Format</b> A = AC in AC out *E = AC in AC out, external line reactor</p>
---	---	---	---	---

\*Frame 9 only

# MODEL NUMBER AND RATINGS

Model No.	Frame Size	Supply Phases	Heavy Duty			Normal Duty		
			Max Cont. Current (A)	Motor Power (kW)	Motor Power (hp)	Max Cont. Current (A)	Motor Power (kW)	Motor Power (hp)
<b>100V (100V-120V +/-10%)</b>								
M400-01100017A	1	1	1.7	0.25	0.33			
M400-01100024A	1	1	2.4	0.37	0.5			
M400-01100042A	1	1	4.2	0.75	1			
M400-01100056A	1	1	5.6	1.1	1.5			
<b>200V (200V-240 +/-10%)</b>								
M400-01200017A	1	1	1.7	0.25	0.33			
M400-01200024A	1	1	2.4	0.37	0.50			
M400-01200033A	1	1	3.3	0.55	0.75			
M400-01200042A	1	1	4.2	0.75	1.0			
M400-02200024A	2	1/3	2.4	0.37	0.5			
M400-02200056A	2	1/3	3.3	0.55	0.75			
M400-02200056A	2	1/3	4.2	0.75	1.0			
M400-02200056A	2	1/3	5.6	1.1	1.5			
M400-02200056A	2	1/3	7.5	1.5	2.0			
M400-03200056A	3	1/3	10.0	2.2	3.0			
M400-04200056A	4	1/3	13.3	3.0	3.0			
M400-04200056A	4	3	17.6	4.0	5.0			
M400-05200056A	5	3	25.0	5.5	7.5	30	7.5	10
M400-06200056A	6	3	33.0	7.5	10.0	50	11.0	15
M400-06200056A	6	3	44.0	11.0	15.0	58	15.0	20
M400-07200056A	7	3	61.0	15.0	20.0	75	18.5	25
M400-07200056A	7	3	75.0	18.5	25.0	94	22.0	30
M400-07200056A	7	3	83.0	22.0	30.0	117	30.0	40
M400-08200056A	8	3	116.0	30.0	40.0	149	37.0	50
M400-08200056A	8	3	132.0	37.0	50.0	180	45	60
M400-09200056A/E	9	3	176.0	45.0	60.0	216	55	75
M400-09200056A/E	9	3	210.0	55.0	75.0	266	75	100

Model No.	Frame Size	Supply Phases	Heavy Duty			Normal Duty		
			Max Cont. Current (A)	Motor Power (kW)	Motor Power (hp)	Max Cont. Current (A)	Motor Power (kW)	Motor Power (hp)
<b>400V (380V-480V +/-10%)</b>								
M400-02400013A	2	3	1.3	0.37	0.5			
M400-02400018A	2	3	1.8	0.55	0.75			
M400-02400023A	2	3	2.3	0.75	1.0			
M400-02400032A	2	3	3.2	1.1	1.5			
M400-02400041A	2	3	4.1	1.5	2.0			
M400-03400056A	3	3	5.6	2.2	3.0			
M400-03400073A	3	3	7.3	3.0	3.0			
M400-03400094A	3	3	9.4	4.0	5.0			
M400-04400135A	4	3	13.5	5.5	7.5			
M400-04400170A	4	3	17.0	7.5	10.0			
M400-05400270A	5	3	27.0	11.0	20.0	30	15	20
M400-05400300A	5	3	30.0	15.0	20.0	31	15	20
M400-06400350A	6	3	35.0	15.0	25.0	38	18.5	25
M400-06400420A	6	3	42.0	18.5	30.0	48	22.0	30
M400-06400470A	6	3	47.0	22.0	30.0	63	30.0	50
M400-07400660A	7	3	66.0	30.0	50.0	79	37.0	60
M400-07400770A	7	3	77.0	37.0	60.0	94	45.0	75
M400-07401000A	7	3	100.0	45.0	75.0	112	55.0	75
M400-08401340A	8	3	134.0	55.0	100	155	75.0	100
M400-08401570A	8	3	157.0	75.0	125	184	90.0	125
M400-09402000A/E	9	3	200.0	90.0	150	221	110.0	150
M400-09402240A/E	9	3	224.0	110.0	150	266	132.0	200

Heavy Duty rating only

## Documentation & Downloads

Product documentation and PC tools available for download from:  
[www.controltechniques.com/support](http://www.controltechniques.com/support)

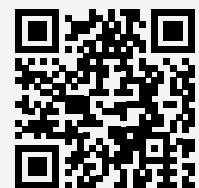

Model No.	Supply Phases	Heavy Duty			Normal Duty		
		Max Cont. Current (A)	Motor Power (kW)	Motor Power (hp)	Max Cont. Current (A)	Motor Power (kW)	Motor Power (hp)
<b>500/575 Vac ±10 %</b>							
M400-055 00030 A	3	3.0	1.5	2.0	3.9	2.2	3.0
M400-055 00040 A	3	4.0	2.2	3.0	6.1	4.0	5.0
M400-055 00069 A	3	6.9	4.0	5.0	10.0	5.5	7.5
M400-065 00100 A	3	10.0	5.5	7.5	12.0	7.5	10.0
M400-065 00150 A	3	15.0	7.5	10.0	17.0	11.0	15.0
M400-065 00190 A	3	19.0	11.0	15.0	22.0	15.0	20.0
M400-065 00230 A	3	23.0	15.0	20.0	27.0	18.5	25.0
M400-065 00290 A	3	29.0	18.5	25.0	34.0	22.0	30.0
M400-065 00350 A	3	35.0	22.0	30.0	43.0	30.0	40.0
M400-075 00440 A	3	44.0	30.0	40.0	53.0	37.0	50.0
M400-075 00550 A	3	55.0	37.0	50.0	73.0	45.0	60.0
M400-085 00630 A	3	63.0	45.0	60.0	86.0	55.0	75.0
M400-085 00860 A	3	86.0	55.0	75.0	108.0	75.0	100.0
M400-095 01040 A	3	104.0	75.0	100.0	125.0	90.0	125.0
M400-095 01310 A	3	131.0	90.0	125.0	150.0	110.0	150.0
<b>500/690 Vac ±10 %</b>							
M400-076 00190 A	3	19.0	15.0	20.0	23.0	18.5	25.0
M400-076 00240 A	3	24.0	18.5	25.0	30.0	22.0	30.0
M400-076 00290 A	3	29.0	22.0	30.0	36.0	30.0	40.0
M400-076 00380 A	3	38.0	30.0	40.0	46.0	37.0	50.0
M400-076 00440 A	3	44.0	37.0	50.0	52.0	45.0	60.0
M400-076 00540 A	3	54.0	45.0	60.0	73.0	55.0	75.0
M400-086 00630 A	3	63.0	55.0	75.0	86.0	75.0	100.0
M400-086 00860 A	3	86.0	75.0	100.0	108.0	90.0	125.0
M400-096 01040 A	3	104.0	90.0	125.0	125.0	110.0	150.0
M400-096 01310 A	3	131.0	110.0	150.0	150.0	132.0	175.0

## EXTREME POWER

# 500 kW DRIVE

**315 kW to 500 kW | Up to 865 A | 380 to 480 VAC ( $\pm 10\%$ )**  
with 110% Overload

**While low power accounts for most of the growth for variable speed drives, energy-saving applications are driving growth in high power drives.**

Fans, pumps, compressors and extruders are common uses of drives that increasingly need a higher power option.

**Control Techniques' largest high power drive, offers 500 kW of power in a single module, but at 130kg is up to 60kg lighter than competitors drives.**

Its small footprint and pre-engineered accessories make it easy to install or retrofit in industry-standard cubicles.

### **A choice of control module options**

**This 500 kW drive can be fitted with a Unidrive M600/ M70X or Pump Drive F600 control module and has a wide range of accessories available for easy installation.**

Alternatively, the frame can be provided pre-assembled in its own industry-standard cabinet, with user-selectable system components included.

This is the ready to use DFS series free standing version.





# DRIVE RATINGS & ORDERING INFORMATION

Product Code	No Overload		Heavy Duty			Normal Duty		
	Max. Cont. Output Current (A)	Nominal Power at 400 V	Max Cont. Current (A)	Peak Current (A)	Nominal Power at 400 V (kW)	Max Cont. Output Current (A)	Peak Current (A)	Nominal Power at 400 V (kW)
M000-12404800T	635	315	608	668	315	480	528	250
M000-12405660T	689	355	660	726	355	566	792	375
M000-12406600T	788	450	755	831	400	660	924	355
M000-12407200T	903	500	865	952	500	720	1008	400

Internal 125 kW brake chopper included as standard

\*At 2 kHz switching frequency

## DIMENSIONS

Width	Height	Depth
295mm	1750mm	526mm



### Documentation & Downloads

Product documentation and PC tools available for download from:  
[www.controltechniques.com/support](http://www.controltechniques.com/support)

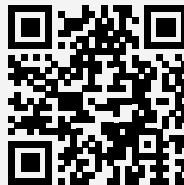

# FREE STANDING DRIVES

**DFS SERIES**

# DFS SERIES

# PRE-ASSEMBLED CUBICLE DRIVES

### Efficient System Build.

Designing and building a high power drive cubicle takes immense engineering knowhow. Most people don't have that expertise in-house. But we do. And we've put it all into our DFS freestanding drives.

The cubicle system is designed to handle high power applications – maximum energy efficiency and ingress protection when you need it most. The drives are pre-assembled, they're easy to set up. Just install the cubicle and flick the switch. Maximum plant availability, minimum technical wizardry required.



Fans & Pumps



General Automation



Compressors



# SPECIFICATION

Feature	Description
Enclosure rating	A = IP23 (Standard) C = IP54 - Air inlet grill filters
Electrical environment	EMC filter to meet generic emission IEC 61000-6-4 or operate in the First Environment Remove internal EMC filter for use on un earthed supplies Remove MOV protection for use on un earthed supplies
AC Input Disconnect	A - Main switch with undervoltage release coil 230 VAC (MN) B - Main switch with undervoltage release coil 24 VAC (MN) C - Main switch with shunt trip voltage release coil 230 VAC (MX) D - Main switch with shunt trip voltage release coil 24 VAC (MX) 2 x auxiliary contacts on main switch - supply and wiring
Emergency stop push button door mounted	For integration in your control system
Cubicle Options	Cabinet temperature-controlled roof fan Plinth 200 mm. Standard plinth is 100 mm Alternative 180 ° door hinges for improved access Cylinder lock with key for extra cubicle security
Energy Monitoring	A - kWh meter Conventional (IP54) with current transducers (non MID) B - kWh meter Modbus RTU with current transducers (non MID) C - kWh meter Profibus (400 V SUPPLY ONLY) with current transducers (non MID) D - kWh meter Ethernet with current transducers (non MID) kWh meter pulse contacts in combination with A, B, C OR D kWh meters
24 V back-up power	Supply wiring installed for external 24V backup power supply
Additional Cubicles	A - Integrated 400 mm empty cubicle with plinth, cable plates INCLUDING mounting plate - for your system equipment B - Integrated 400 mm empty cubicle with plinth, cable plates and WITHOUT mounting plate - for your installation cable management
Packaging	Packaging for land freight as standard Packaging for air freight available at extra cost

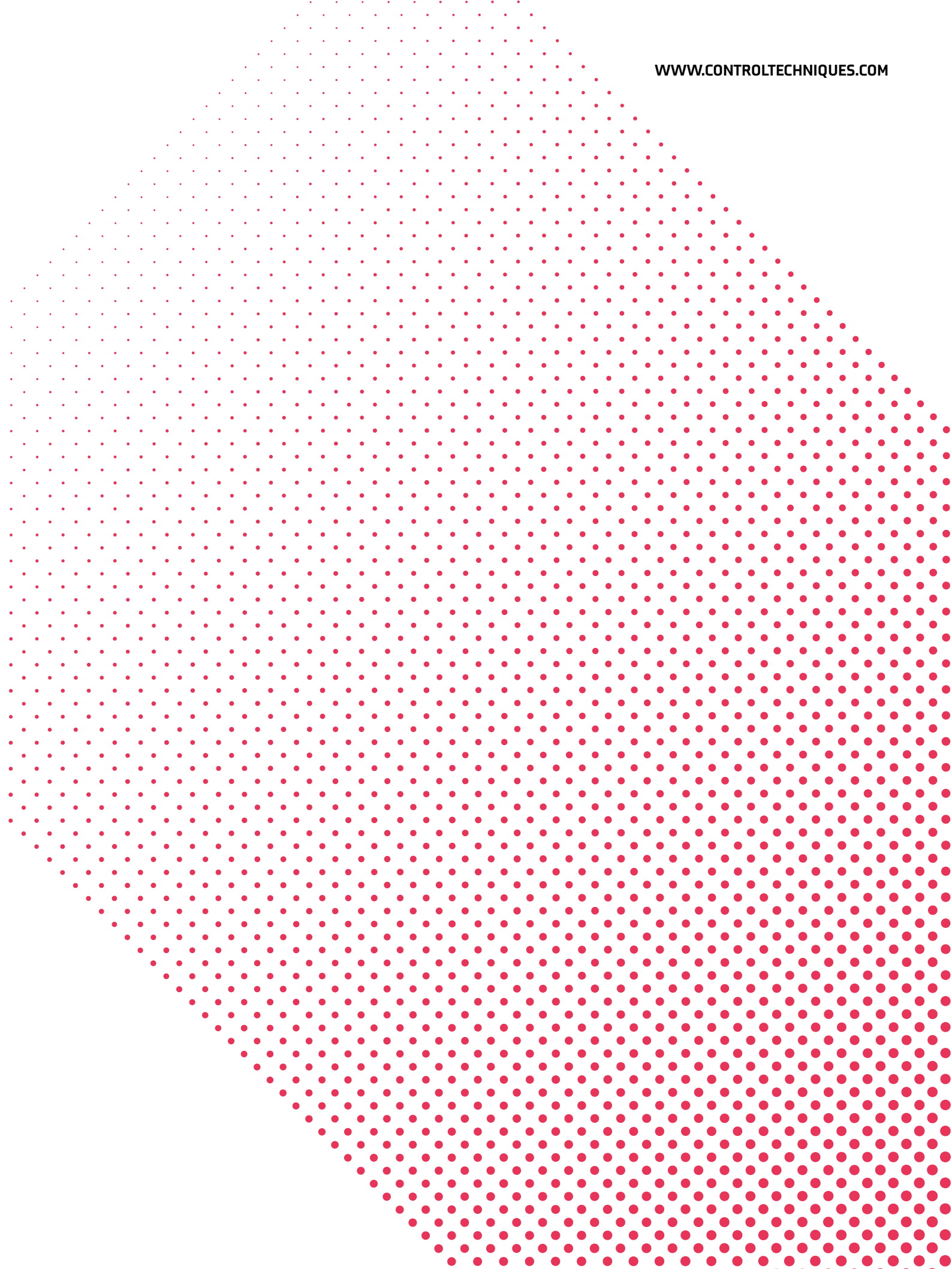

# DIMENSIONS



Dimensions	
A	IP23 or IP54 up to 180 mm
B	2000 mm
C	100 or 200 mm
D	IP23 or IP54 – 600 mm
E	DFS1 – 400 mm DFS2 – 1200 mm

# ORDERING GUIDE

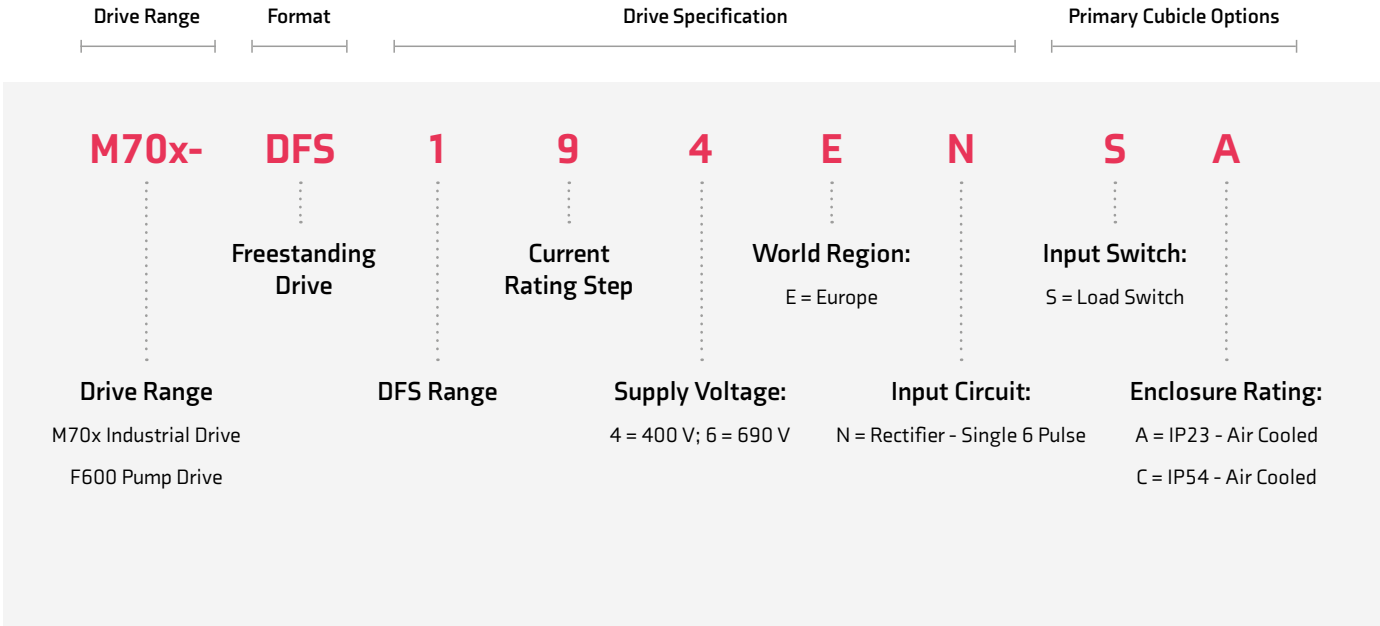

## Documentation & Downloads

Product documentation and PC tools available for download from:  
[www.controltechniques.com/support](http://www.controltechniques.com/support)

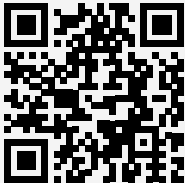

# MODEL NUMBER AND RATINGS

Drive selection for 380/480 VAC: Load switch, fuses and IP23 protection as standard 40°

35°C Ambient   IP23 and IP54				
380/480 VAC ±10%   50 Hz				
Order Code (Short)	Normal Duty 110 %		Heavy Duty Open Loop = 150 % RFC = 175 %	
	xxxx = F600, M700, M701, M702		xxxx = M700, M701, M702	
	Max Cont. Current	Motor Shaft Power	Max Cont. Current	Motor Shaft Power
	(A)	(kW)	(A)	(kW)
xxxx-DFS1G4EN	155	75	134	55
xxxx-DFS1H4EN	184	90	157	75
xxxx-DFS1J4EN	221	110	180 200 (2 kHz)	90
xxxx-DFS1K4EN	255 266 (2 kHz)	132 132 (2 kHz)	211 224 (2 kHz)	110 110 (2 kHz)
xxxx-DFS1L4EN	320	160	270	132
xxxx-DFS1M4EN	361	200	307 320 (2 kHz)	160 160 (2 kHz)
xxxx-DFS1N4EN	437	225	377	200
xxxx-DFS1P4EN	460 487 (2 kHz)	250 250 (2 kHz)	417	225
xxxx-DFS1Q4EN	460 507 (2 kHz)	250 280 (2 kHz)	415 464 (2 kHz)	225 250 (2 kHz)
xxxx-DFS2L4EN	608	315	513	270
xxxx-DFS2M4EN	686	370	583 608 (2 kHz)	315 315 (2 kHz)
xxxx-DFS2N4EN	830	450	716	380
xxxx-DFS2P4EN	874 925 (2 kHz)	470 500 (2 kHz)	792	420
xxxx-DFS2Q4EN	874 963 (2 kHz)	470 520 (2 kHz)	789 882 (2 kHz)	420 470 (2 kHz)

40°C Ambient   IP23 and IP54				
380/480 VAC ±10%   50 Hz				
Order Code (Short)	Normal Duty 110 %		Heavy Duty Open Loop = 150 % RFC = 175 %	
	xxxx = F600, M700, M701, M702		xxxx = M700, M701, M702	
	Max Cont. Current	Motor Shaft Power	Max Cont. Current	Motor Shaft Power
	(A)	(kW)	(A)	(kW)
xxxx-DFS1G4EN	155	75	134	55
xxxx-DFS1H4EN	184	90	152	75
xxxx-DFS1J4EN	221	110	180 200 (2 kHz)	90
xxxx-DFS1K4EN	221 221 (2 kHz)	132	180 200 (2 kHz)	110
xxxx-DFS1L4EN	320	160	270	132
xxxx-DFS1M4EN	341	200	295 314 (2 kHz)	160
xxxx-DFS1N4EN	426 437 (2 kHz)	225	377	200
xxxx-DFS1P4EN	438 475 (2 kHz)	250	398 416 (2 kHz)	225
xxxx-DFS1Q4EN	438 485 (2 kHz)	250 280 (2 kHz)	398 441 (2 kHz)	225 250 (2 kHz)
xxxx-DFS2L4EN	608	315	513	270
xxxx-DFS2M4EN	648 669 (2 kHz)	370	560 596 (2 kHz)	315
xxxx-DFS2N4EN	809 830 (2 kHz)	450	716	380
xxxx-DFS2P4EN	831 902 (2 kHz)	470 500 (2 kHz)	755 790 (2 kHz)	420
xxxx-DFS2Q4EN	831 921 (2 kHz)	470 520 (2 kHz)	755 838 (2 kHz)	420 470 (2 kHz)

**Notes:**

- 3kHz Switching Frequency except where stated otherwise
- "kW" are motor dependant and for indication only
- A braking transistor is included in all drives
- Remaining digits of order code generated automatically for customer selected cubicle options

**\*Higher powers can be quoted on request**



**Drive selection for 500/690 VAC: Load switch, fuses and IP23 protection as standard**

35°C Ambient   IP23 and IP54				
500/690 VAC   ±10%   50 Hz				
Order Code (Short)	Normal Duty 110 %		Heavy Duty Open Loop = 150 % RFC = 175 %	
	xxxx = F600, M700, M701, M702		xxxx = M700, M701, M702	
	Max Cont. Current	Motor Shaft Power	Max Cont. Current	Motor Shaft Power
	(A)	(kW)	(A)	(kW)
xxxx-DFS166EN	86	75	63	55
xxxx-DFS176EN	108	90	86	75
xxxx-DFS186EN	125	110	104	90
xxxx-DFS196EN	155	132	131	110
xxxx-DFS1A6EN	172	160	150	132
xxxx-DFS1B6EN	197	185	178	160
xxxx-DFS1C6EN	225	200	210	185
xxxx-DFS1D6EN	265	235	221	185
	275 (2 kHz)	250 (2 kHz)	238 (2 kHz)	200 (2 kHz)
xxxx-DFS1E6EN	265	235	221	185
	305 (2 kHz)	280 (2 kHz)	263 (2 kHz)	250 (2 kHz)
xxxx-DFS2A6EN	327	300	285	260
xxxx-DFS2B6EN	374	355	338	315
xxxx-DFS2C6EN	428	400	399	370
xxxx-DFS2D6EN	504	440	420	370
	523 (2 kHz)	490 (2 kHz)	452 (2 kHz)	420 (2 kHz)
xxxx-DFS2E6EN	504	440	420	370
	580 (2 kHz)	540 (2 kHz)	500 (2 kHz)	460 (2 kHz)

**Notes:**

- 3kHz Switching Frequency except where stated otherwise
- "kW" are motor dependant and for indication only
- A braking transistor is included in all drives
- Remaining digits of order code generated automatically for customer selected cubicle options

40°C Ambient   IP23 and IP54				
500/690 VAC   ±10%   50 Hz				
Order Code (Short)	Normal Duty 110 %		Heavy Duty Open Loop = 150 % RFC = 175 %	
	xxxx = F600, M700, M701, M702		xxxx = M700, M701, M702	
	Max Cont. Current	Motor Shaft Power	Max Cont. Current	Motor Shaft Power
	(A)	(kW)	(A)	(kW)
xxxx-DFS166EN	86	75	63	55
xxxx-DFS176EN	103	90	86	75
	106 (2 kHz)			
xxxx-DFS186EN	125	110	104	90
xxxx-DFS196EN	155	132	131	110
xxxx-DFS1A6EN	172	160	150	132
xxxx-DFS1B6EN	197	185	178	160
xxxx-DFS1C6EN	215	200	205	185
			210 (2 kHz)	
xxxx-DFS1D6EN	253	235	211	185
	263 (2 kHz)	250 (2 kHz)	238 (2 kHz)	200 (2 kHz)
xxxx-DFS1E6EN	253	235	211	185
	301 (2 kHz)	280 (2 kHz)	254 (2 kHz)	250 (2 kHz)
xxxx-DFS2A6EN	327	300	285	260
xxxx-DFS2B6EN	374	355	338	315
xxxx-DFS2C6EN	409	400	390	370
			399 (2 kHz)	
xxxx-DFS2D6EN	481	440	400	370
	499 (2 kHz)	490 (2 kHz)	452 (2 kHz)	420 (2 kHz)
xxxx-DFS2E6EN	481	440	400	370
	571 (2 kHz)	540 (2 kHz)	483 (2 kHz)	460 (2 kHz)

**\*Higher powers can be quoted on request**

# VARIANTS FOR EVERY APPLICATION

## DFS is available with a control stage to suit any application:

- Industrial automation systems based upon induction or servo motors, where control dynamics are key.
- HVAC/R systems where dedicated drive features provide overall system control.
- DFS supports the latest high-efficiency motors to maximise return on investment and minimise impact on the environment.

## Select from: Unidrive M700, M701, M702 or Pump Drive F600 control

	<b>M700</b>	<b>Ethernet</b>	<ul style="list-style-type: none"> <li>• Onboard real-time multi-protocol Ethernet</li> <li>• 1 x Safe Torque Off (STO) certified to SIL3/PLe</li> <li>• Analogue and digital I/O</li> </ul>
	<b>M701</b>	<b>Unidrive SP replacement</b>	<p>Designed to match Control Techniques' highly popular Unidrive SP feature-set.</p> <ul style="list-style-type: none"> <li>• Modbus RTU over RS485 communications</li> <li>• 1 x STO certified to SIL3/PLe</li> <li>• Analogue and digital I/O</li> </ul>
	<b>M702</b>	<b>Safety enhanced</b>	<ul style="list-style-type: none"> <li>• Onboard real-time multi-protocol Ethernet</li> <li>• 2 x STO certified to SIL3/ PLe</li> <li>• Digital I/O - If Analogue I/O is required, this can be provided by an SI-I/O option module</li> </ul>
	<b>F600</b>	<b>Process</b>	<p>Optimum energy efficiency for pump applications.</p> <p>Pump Drive F600 works with permanent magnet or induction motors to deliver the most efficient performance and highest energy savings for pumps.</p>

Please refer to the individual product brochures for full information

### Output frequency

DFS drives have a maximum output frequency of 599Hz and are, therefore, not subject to special export controls.



# SPECIALIST DRIVES

ELEVATOR | PUMP

# PRODUCTS IN THIS RANGE

ELEVATOR DRIVE E300 | PUMP DRIVE F600



# ELEVATOR DRIVE E300

# DEDICATED DRIVE

# FOR CLASS-LEADING

# RIDE COMFORT

## Your top choice for every project.

Our elevator drive solutions work for any size of building. Whether it's a small residential building or a luxury high rise, new build or modernization projects, we make every step of the process as easy as possible from product selection to installation, setup and service.

## Contactorless operation

Control Techniques' drive range provides contactorless operation in elevator applications.

Our EN81-20, EN81-50 TÜV certified Safe Torque Off (STO) function provides a highly dependable method for preventing the motor from being driven. This removes the need for both output motor contactors.

The benefits of switching to a contactorless solution include:

- Reduced EMC issues
- Reduced acoustic noise
- Improved system reliability
- Simplified electrical installation
- Lower system costs
- Minimised cabinet space allowing machine room-less installation

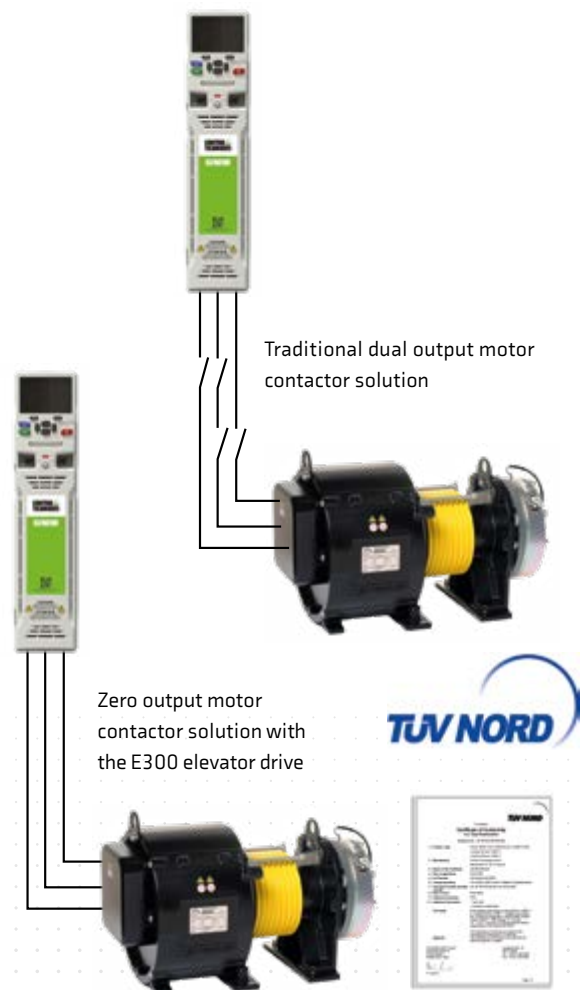

# KEY FUNCTIONS

Function	Function	Function	Function
Analogue input control: 3 ✓	S-Ramps: 4 programmable ✓	Supply - Input Phase Loss Detection ✓	Separate Start, Run, Stop speed loop gains ✓
Analogue output control: 2 ✓	Acceleration Rate: 1 ✓	Motor - Output Phase Loss Detection ✓	Separate Start, Run, Stop current loop filters ✓
Bi-polar analogue reference: 1 ✓	Deceleration Rate: 1 ✓	Temperature monitoring ✓	Velocity threshold outputs: 3 ✓
Digital input control: 9 Maximum ✓	Elevator control mode: Creep to Floor Operation Direct to Floor Operation ✓	Variable heatsink fan control ✓	Speed & Distance error detection ✓
Digital output control: 4 Maximum ✓	Drive control mode: Open-loop V/F Fixed Boost (IM) Open-loop Vector (IM) ✓	Low voltage DC link operation: User defined DC level ✓	Logic: Variable selector ✓
Relay control: 1 ✓	Drive control mode: Closed-loop Vector + Feedback (IM) Closed-loop Vector Sensor-less (IM) ✓	Elevator load & direction measurement at start ✓	Logic: Motorised pot ✓
Digital preset control: Binary & Priority control ✓	Drive control mode: Closed-loop Servo + Feedback (PM) Closed-loop Vector Sensor-less (PM) ✓	Low voltage braking ✓	Logic: Threshold control ✓
Pre-set speeds: 10 Binary, 7 Priority ✓	Auto-tune Stationary (including PM motors) ✓	UPS overload protection: Low voltage DC link operation ✓	Logic: Logic function ✓
Analogue reference control: Analogue input 1 ✓	Auto-tune Rotating ✓	Elevator load cell support ✓	Multilingual Keypad ✓
Control word control: Control & status word ✓	Stator resistance compensation ✓	Start locking position controller ✓	Keypad button assignment ✓
DCP3 DCP4 control: SI option module required ✓	Slip compensation ✓	Start optimiser ✓	Trip time stamping ✓
CANOpen CiA 417 control: SI option module required ✓	DC injection braking ✓	Inertia compensation ✓	Trip logging ✓
Digital override velocity and acceleration control ✓	Motor thermal protection: 5 modes ✓	Peak curve operation ✓	Run time log ✓
Motor brake controller ✓	Motor torque ramp: Start Stop ✓	Short floor operation ✓	Programmable auto reset ✓
Brake Contact Monitoring (x 4 brakes): TUV approved to EN81 ✓	Encoder auto configuration: EnDat, SC.EnDat, SC.Hiperface ✓	Fast stop ✓	Cloning ✓
Programmable braking ✓	Software encoder reversal ✓	Rapid slow down ✓	Additional Application parameters ✓
Braking resistor thermal protection ✓	High speed mode: PM motors ✓	Floor sensor correction ✓	Speed feedback via options ✓
Motor contactor controller ✓	Field weakening operation: IM motors ✓	Fast disable: Output motor shorting contactor ✓	User programmable User Menu A, 80 parameters ✓
Motor contactor monitoring ✓	Software motor phase rotation ✓	Fast start ✓	
Zero output motor contactor SIL3 STO: TUV approved to EN81 ✓	Supply loss detection ✓	Blocked elevator car release ✓	

# SPECIFICATION

Feature	Description
Items supplied with the drive	Safety Information, Quality Certificate, Control signal connectors, 24V power supply connector (frames 6 to 11), Grounding bracket, Surface mounting brackets, DC connection grommets (frames 3 to 6), Supply and motor connectors (frames 3 to 5), Nuts for supply and motor terminals (frames 6 to 11)
Storage temperature	-40°C to 55°C, -40°F to 131°F
Operating temperature without de-rate	-20°C to 40°C, -4°F to 104°F
Operating temperature with de-rate	40°C to 55°C, 104°F to 131°F
Supply requirements	<p>AC supply voltage:</p> <p>200 V drive: 200 V to 240 V ±10 %</p> <p>400 V drive: 380 V to 480 V ±10 %</p> <p>575 V drive: 500 V to 575 V ±10 %</p> <p>690 V drive: 500 V to 690 V ±10 %</p> <p>Number of phases: 3</p> <p>Maximum supply imbalance: 2 % negative phase sequence (3 % voltage imbalance between phases).</p> <p>Frequency range: 45 to 66 Hz</p> <p>For UL compliance only, the maximum supply symmetrical fault current must be limited to 100 kA</p>
Switching frequency range	2,3,4,6,8,12,16kHz (Factory default = 8kHz Open-loop/RFC-A/RFC-S)
Approvals	<p>CE approval – Europe</p> <p>RCM regulatory compliance mark – Australia</p> <p>UL / cUL approval – USA &amp; Canada</p> <p>RoHS compliant – Europe</p> <p>Functional safety – USA &amp; Canada</p> <p>Eurasian conformity – Eurasia</p>
Product safety standard	<p>EN 61800-5-1:2016 Adjustable speed electrical power drive systems - Part 5-2: Safety requirements – Functional</p> <p>EN 61800-5-1:2016 (in extracts) Adjustable speed electrical power drive systems - Part 5-1: Safety requirements - Electrical, thermal and energy</p> <p>EN 61800-3: 2004+A1:2012 Adjustable speed electrical power drive systems - Part 3: EMC requirements and specific test methods</p> <p>EN ISO 13849-1:2015 Safety of Machinery, Safety-related parts of control systems, General principles for design</p> <p>EN 62061:2005 + AC:2010 + A1:2013 + A2:2015 Safety of machinery, Functional safety of safety related electrical, electronic and programmable electronic control systems</p> <p>IEC 61508 Parts 1 - 7:2010 Functional safety of electrical/ electronic/programmable electronic safety-related systems</p>
Altitude	1000m – No de-rate. 1000m to 3000m - 1% de-rate/100m
Humidity	95% Non-condensing at 40 °C (104 °F)
Pollution	Degree 2. Dry, non-conducting pollution only
IP Rating	<p>IP20 / NEMA1 / UL TYPE 1 (UL open class as standard, additional kit needed to achieve Type 1)</p> <p>IP65 / NEMA4 / UL TYPE 12 rating on the rear of drive when through panel mounted (Frames 3 to 8)</p> <p>IP55 / NEMA4 / UL TYPE 12 rating on the rear of drive when through panel mounted (Frames 9 to 11)</p>



<b>Vibration</b>	Reference standard IEC60068-2-27, IEC60068-2-29 bump test, IEC60068-2-64 random vibration test, IEC60068-2-6, EN61800-5-1 sinusoidal vibration test. Tested to Environmental Category ENV3.
<b>Mounting methods</b>	Frame 3 to 11 – Surface mount (supplied mounting brackets) or through-panel mount (optional mounting brackets). Frame 3 to 5 – Tile mount (optional mounting brackets)
<b>Output frequency/speed range</b>	599Hz (Open-loop), 560Hz (RFC-A, RFC-S)
<b>Braking</b>	In-built braking transistor for use with external braking resistor (all frames)
<b>Operating modes</b>	Open-loop: Open-loop vector, fixed V/F RFC-A: Rotor Flux Control for Asynchronous motors, with or without position feedback RFC-S: Rotor Flux Control for Synchronous motors, with or without position feedback
<b>Overload capability</b>	Heavy duty: Open-loop 150% overload, RFC 175% overload with CT profile, RFC 200% max overload.
<b>Overvoltage category</b>	Evaluated for Over Voltage Category III.
<b>Corrosive environments</b>	Concentrations of corrosive gases must not exceed the levels given in: Table A2 of EN 50178:1998, Class 3C2 of IEC 60721-3-3 This corresponds to the levels typical of urban areas with industrial activities and/or heavy traffic, but not in the immediate neighbourhood of industrial sources with chemical emissions.
<b>Immunity Compliance</b>	IEC EN 61000-4-2 Electrostatic discharge IEC EN 61000-4-3 Radio frequency radiated field IEC EN 61000-4-4 Fast transient burst IEC 61000-4-5 Surges IEC EN 61000-4-6 Conducted radio frequency IEC EN 61000-4-11 Voltage dips, short interruptions & variations IEC EN 61000-6-1 Electromagnetic compatibility residential, commercial and light-industrial environments IEC EN 61000-6-2 Electromagnetic compatibility for industrial environments IEC 61800-3 Adjustable speed electrical power drive systems - Part 3: EMC requirements EN12016:2013 Electromagnetic compatibility standard for lifts, escalators and moving walks Immunity
<b>Emission compliance</b>	Meets requirements of Equipment Category C3, C4 without external filters or line reactors. Meets requirements of Equipment Category C2 with the recommended external filters and line reactors. IEC 61800-3 Electromagnetic compatibility (EMC) requirements for power drive systems IEC EN 61000-3-2 Electromagnetic compatibility - Limits for harmonic current emissions IEC EN 61000-3-3 Electromagnetic compatibility Limitation of voltage changes, voltage fluctuations and flicker in public low-voltage supply systems $\leq 16$ A IEC EN 61000-3-11 Electromagnetic compatibility Limitation of voltage changes, voltage fluctuations and flicker in public low-voltage supply systems $< 16$ A $< 75$ A IEC EN 61000-3-12 Electromagnetic compatibility Limits for harmonic currents produced by equipment connected to public low-voltage systems $> 16$ A and $\leq 75$ A per phase IEC EN 61000-6-4 Electromagnetic compatibility (EMC) Emission standard for industrial environments EN 12015:2014, Electromagnetic compatibility standard for lifts, escalators and moving walks Emission
<b>Cooling</b>	Heatsink: Variable speed forced controlled heatsink cooling fans Internal: Variable speed internal power stage cooling fans
<b>Safe Torque Off</b>	Single STO channel. SIL 3
<b>Communications</b>	Onboard: RS485, Modbus/TCP SI Options: Ethernet, CANopen, DCP
<b>Control I/O</b>	3 x Analogue input (1 x differential, 2 x single ended), 2 x Analogue output, 3 x Digital I/O programmable, 3 x Digital input (including 2 x high speed – 250µs), 1 x NO relay 250Vac Max., 6 x 0V common, 1 x 24V supply input (additional digital input), 1 x 24V user output (additional digital output), 1 x 10V user output, 1 x Safe Torque Off input. Additional I/O also available with SI-I/O option module.

**Supported Feedback Devices**

Supports a combination of main encoder feedback and a simulated encoder output from a single high-density connector:  
 AB (0) Quadrature incremental encoders with or without marker pulse  
 AB Servo (3) Quadrature incremental encoders with UVW commutation signals for absolute position for permanent magnet motors with or without marker pulse  
 FR (2) Forward / reverse incremental encoders with or without marker pulse  
 FR Servo (5) Forward / reverse incremental encoders with UVW commutation signals for absolute position for permanent magnet motors with or without marker pulse  
 FD (1) Frequency and direction incremental encoders with or without marker pulse  
 FD Servo (4) Frequency and direction incremental encoders with UVW commutation signals for absolute position for permanent magnet motors with or without marker pulse  
 SC (6) Sincos incremental encoders  
 SC Servo (12) Sincos incremental with commutation signals  
 SC EnDat (9) Heidenhain sincos encoders with EnDat comms for absolute position  
 SC Hiperface (7) Stegmann sincos encoders with Hiperface comms for absolute position  
 SC SSI (11) Sincos encoders with SSI comms for absolute position  
 SC BiSS (17) Sincos encoders with BiSS (type C) comms for absolute position  
 SC SC (15) Sincos incremental with absolute position from single sin and cosine signals  
 SSI (10) SSI encoders (Gray code or binary)  
 EnDat (8) EnDat communication only encoders  
 BiSS (13) BiSS (type C) communication only encoders  
 Resolver (14) Resolver  
 Commutation only (16) UVW commutation only encoders\*  
 \* This feedback device provides very low-resolution feedback

<b>Resolution and Accuracy</b>	Frequency/speed accuracy: 0.01% (preset speed) Open loop resolution – Preset reference: 0.1 Hz, Precision reference: 0.001 Hz Closed loop resolution: Preset reference: 0.1 rpm, Precision reference: 0.001 rpm Differential Analog input 1: 12 bit (11 bit plus sign) Single ended Analog input 2 & 3: 12 bit (11 bit plus sign)
<b>Onboard advanced motion controller</b>	N/A
<b>On-Board user program capability</b>	N/A
<b>Optional Second Processor (PLC / Motion)</b>	SI-Applications Plus: allows application programming to be used MCI200: Advanced Machine Controller using industry standard IEC61131-3 programming languages MCI210: Extended Advanced Machine Controller using industry standard IEC61131-3 programming languages with simultaneous connectivity to 2 separate Ethernet networks
<b>Keypad</b>	Remote-Keypad RTC with real-time clock
<b>Parameter backup and cloning</b>	Smartcard and NV Media Card (using NV Media Card adapter)
<b>PC Tools</b>	Connect: Commissioning and cloning tool CT Scope: Oscilloscope Machine Control Studio: Second processor programming Drive Profiling Tool: Drive estimated thermal profiling
<b>Warranty</b>	26 months
<b>Supported options</b>	Remote-Keypad RTC, KI-485 Adapter, RS485-Communications lead, SI-Ethernet, SI-CANopen, SI-DCP, SI-I/O, SI-Encoder, SI-Universal Encoder, SI-Applications Plus, SI Applications Compact, MCI200, MCI210, Smartcard, NV Media Card (using NV Media Card adapter)
<b>Accessories</b>	Through-hole IP65 mounting kit, UL type conduit kits, SP Retrofit mounting brackets, External EMC filters, Grounding bracket (supplied with the drive)

# DIMENSIONS

Frame Size	Overall Dimensions						Mounting Dimensions				Mounting hole Dia.		Weight	
	mm			in			mm		in		mm	in	kg	lb
	H**	W	D	H**	W	D	H	W	H	W				
3	365	83	200	14.37	3.27	7.87	370	73	14.57	2.87	5	0.2	4.0* 4.5	8.8* 9.9
4	365	124	200	14.37	4.88	7.87	375	106	14.76	4.17	6	0.23	6.5	14.3
5	365	143	200	14.37	5.63	7.87	375	106	14.76	4.17	6.5	0.26	7.4	16.3
6	365	210	227	14.37	8.27	8.94	378	196	14.88	7.72	7	0.28	14	30.9
7	508	270	280	20	10.63	11.02	538	220	21.18	8.66	9	0.35	28	61.7
8	753	310	290	29.65	12.21	11.42	884	259	30.87	10.2	9	0.35	52	114.6
9E/10E	1010	310	290	39.7	12.21	11.42	1051	259	41.38	10.2	9	0.35	46	101.4
9A	1049	310	290	41.3	12.21	11.42	1090	259	42.91	10.2	9	0.35	66.5	146.6
11E	1190	310	312	46.9	12.2	48.9	1222	259	48.11	10.2	9	0.35	63	138.9



\* 034300078, 034300100 weigh 4.5 kg (9.9 lbs), all other variants weigh 4.0 kg (8.8 lbs)

\*\* Overall dimensions do not include removable mounting brackets

# CONNECTIONS

## Typical Power Connections & Default Control Connections

Example for E300 Elevator drive Frame 3, 4, 5 or 6

1. Brake control optional from drive or Elevator controller.
2. Fast disable input only required for systems using output shorting contactor.
3. External protection for the braking circuit and the braking resistor.
4. Communications port E300 Elevator drive.
5. Speeds V1 to V4 are shown as examples.

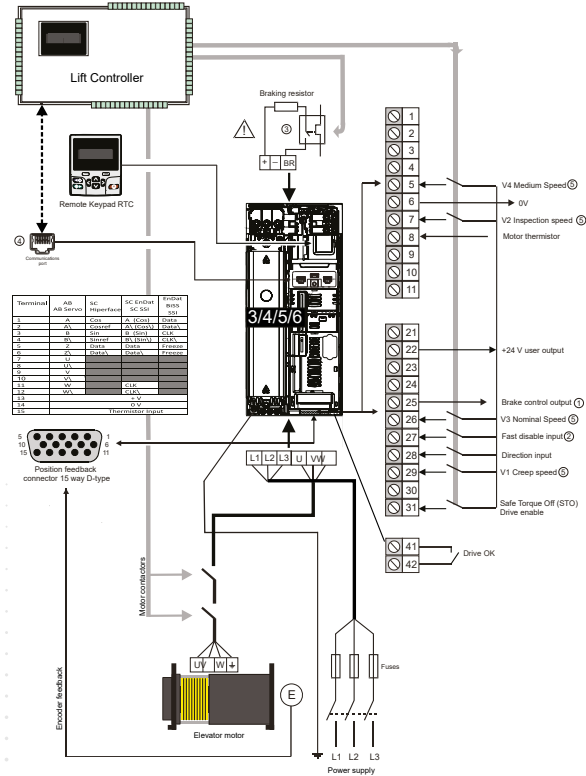

# PART NUMBERS

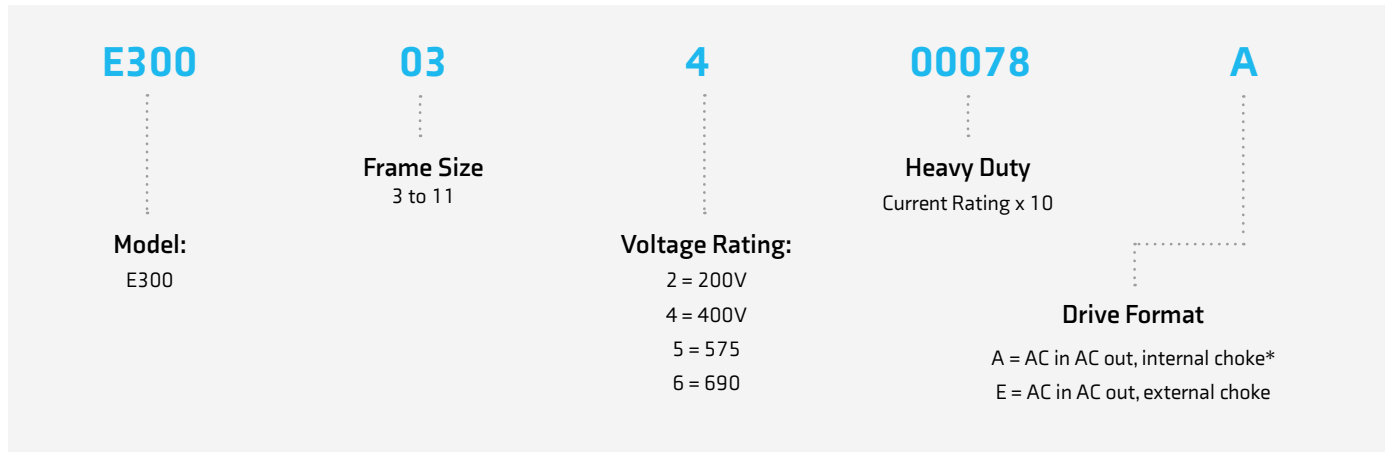

\*Frame 9 and below

# MODEL NUMBER AND RATINGS

Model	Heavy Duty				
	Rated Current	Motor Shaft Power		Peak Current Open Loop	Peak Current RFC
	A	kW	hp	A	A
<b>200V Rated Drives</b>					
E300-3200050	5	0.75	1	7.5	10
E300-3200066	6.6	1.1	1.5	9.9	13.2
E300-3200080	8	1.5	2	12	16
E300-3200106	10.6	2.2	3	15.9	21.2
E300-4200137	13.7	3	3	20.55	27.4
E300-4200185	18.5	4	5	27.75	37
E300-5200250	25	5.5	7.5	37.5	50
E300-6200330	33	7.5	10	49.5	66
E300-6200440	44	11	15	66	88
E300-7200610	61	15	20	91.5	122
E300-7200750	75	18.5	25	112.5	150

Model	Heavy Duty				
	Rated Current	Motor Shaft Power		Peak Current Open Loop	Peak Current RFC
	A	kW	hp	A	A
E300-7200830	83	22	30	124.5	166
E300-8201160	116	30	40	174	232
E300-8201320	132	37	50	198	264
E300-9201760	176	45	60	264	308
E300-9202190	219	55	75	328.5	383.25
E300-10202830	283	75	100	424.5	495.25
E300-10203000	300	90	125	450	525
<b>400V Rated Drives</b>					
E300-3400025	2.5	0.75	1	3.75	5
E300-3400031	3.1	1.1	1.5	4.65	6.2
E300-3400045	4.5	1.5	2	6.75	9
E300-3400062	6.2	2.2	3	9.3	12.4
E300-3400078	7.8	3	5	11.7	15.6
E300-3400100	10	4	5	15	20
E300-4400150	15	5.5	10	22.5	30
E300-4400172	17.2	7.5	10	25.8	34.4
E300-5400220	22	9	12	33	38.5
E300-5400270	27	11	20	40.5	54
E300-5400300	30	15	20	45	60
E300-6400350	35	15	25	52.5	70
E300-6400420	42	18.5	30	63	84
E300-6400470	47	22	30	70.5	94
E300-7400660	66	30	50	99	132
E300-7400770	77	37	60	115.5	154
E300-7401000	100	45	75	150	200
E300-8401340	134	55	100	201	268
E300-8401570	157	75	125	235.5	314
E300-9402000	200	90	150	300	350
E300-9402240	224	110	150	336	392
E300-10402700	270	132	200	405	472.5
E300-10403200	320	160	250	480	560
E300-11403770	377	185	300	565.5	659.75
E300-11404170	417	200	350	625.5	729.75
E300-11404640	464	250	400	696	812

Model	Heavy Duty				
	Rated Current	Motor Shaft Power		Peak Current Open Loop	Peak Current RFC
	A	kW	hp	A	A
<b>575V Rated Drives</b>					
E300-5500030	3	1.5	2	4.5	6
E300-5500040	4	2.2	3	6	8
E300-5500069	6.9	4	5	10.35	13.8
E300-6500100	10	5.5	7.5	15	20
E300-6500150	15	7.5	10	22.5	30
E300-6500190	19	11	15	28.5	38
E300-6500230	23	15	20	34.5	46
E300-6500290	29	18.5	25	43.5	58
E300-6500350	35	22	30	52.5	70
E300-7500440	44	30	40	66	88
E300-7500550	55	37	50	82.5	110
E300-8500630	63	45	60	94.5	126
E300-8500860	86	55	75	129	172
E300-9501040	104	75	100	156	182
E300-9501310	131	90	125	196.5	229.25
E300-10501520	152	110	150	228	266
E300-10501900	190	132	200	285	332.5
E300-11502000	200	150	200	300	350
E300-11502540	254	185	250	381	444.5
E300-11502850	285	225	300	427.5	498.75

## Documentation & Downloads

Product documentation and PC tools available for download from:  
[www.controltechniques.com/support](http://www.controltechniques.com/support)

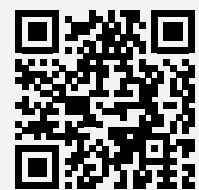

Model	Heavy Duty				
	Rated Current	Motor Shaft Power		Peak Current Open Loop	Peak Current RFC
	A	kW	hp	A	A
<b>690V Rated Drives</b>					
E300-7600190	19	15	20	28.5	38
E300-7600240	24	18.5	25	36	48
E300-7600290	29	22	30	43.5	58
E300-7600380	38	30	40	57	76
E300-7600440	44	37	50	66	88
E300-7600540	54	45	60	81	108
E300-8600630	63	55	75	94.5	126
E300-8600860	86	75	100	129	172
E300-9601040	104	90	125	156	182
E300-9601310	131	110	150	196.5	229.25
E300-10601500	150	132	175	225	262.5
E300-10601780	178	160	200	267	311.5
E300-11602100	210	185	250	315	367.5
E300-11602380	238	200	250	357	416.5
E300-11602630	263	250	300	394.5	460.25

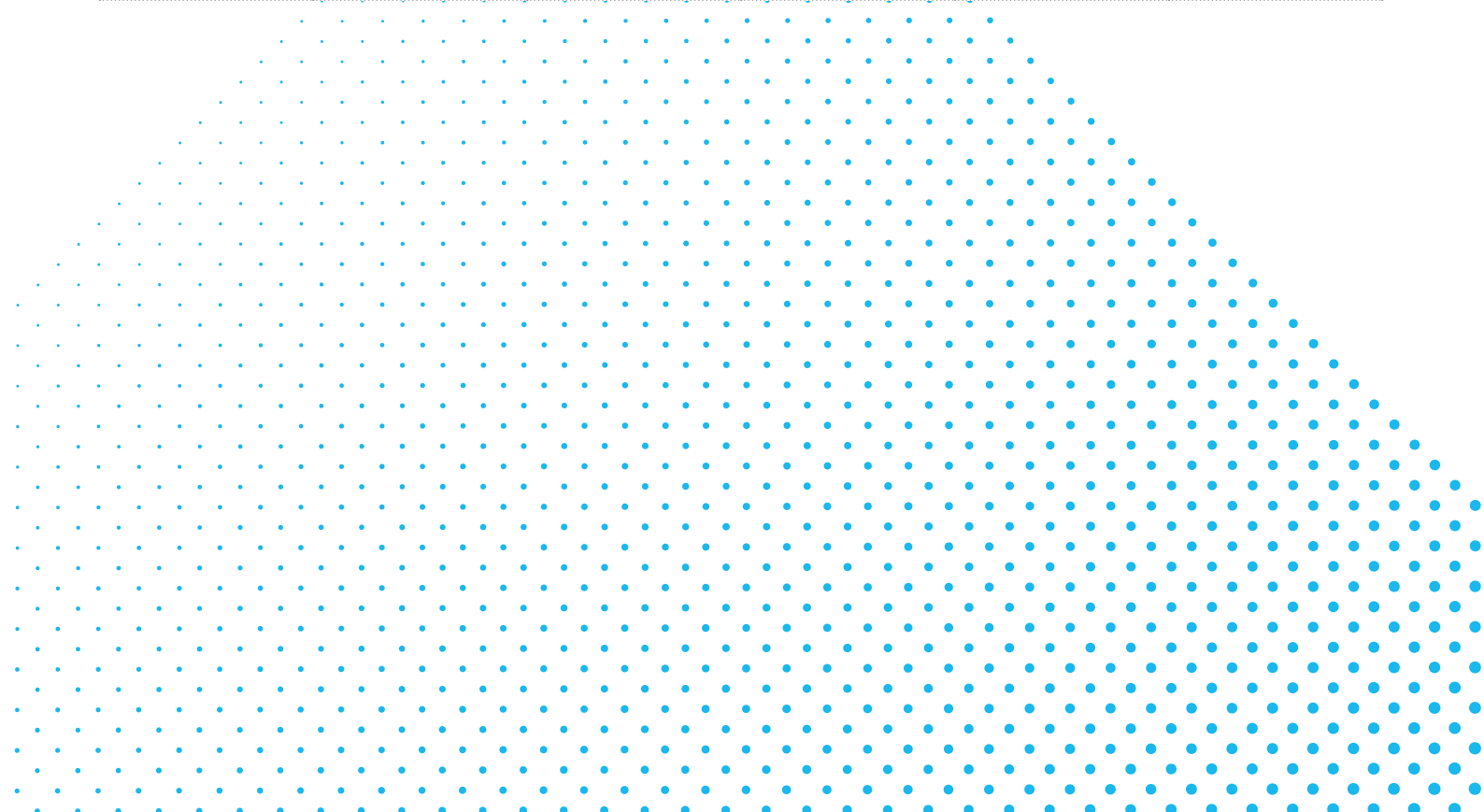

# PUMP DRIVE F600

# THE SPECIALIST

# PUMP DRIVE

Optimised control for your pump solutions

**The perfect mix of application-specific and energy saving features developed into a single solution.**

Applications involving the flow of water demand extreme reliability and low energy consumption. Control Techniques' F600 drive, part of the newly introduced Specialist series of industry-specific drive technologies, builds on our company's five decades of drives expertise, delivering precise, dependable flow control.

Everything you need is baked into the drive itself. The F600 packs all of the features you'll need, presented using terminology you'll understand. This isn't a generic drive with pump features tacked on; it's a dedicated, specialist pump drive, designed from the ground up to deliver the reliability and efficiency you need.



## Free 5 year warranty

To share our confidence in the reliability of Control Techniques, drives in the F600 range are eligible for Control Techniques' extended warranty, at no extra cost.

It is a testament to our exceptional track record for reliability, giving you total peace of mind that your investment is protected and your site will continue to run uninterrupted.

Warranty terms and conditions apply.





# KEY FUNCTIONS

Function		Function		Function	
Pump multi-leader mode for up to 3 drives	✓	Stop mode: Coast	✓	PID Control	2
Pump cascade mode for up to 4 assist pumps	✓	Stop mode: Fast ramp		Energy meter	✓
Control mode: Induction motor operation	✓	Motor pre-heat mode	✓	Trip time stamping	✓
Control mode: Permanent magnet motor operation	✓	Bi-polar reference	✓	Trip logging	10
Pump pipe fill mode	✓	Skip frequencies	✓	Run time log	✓
Pump dry well detection	✓	Fire Mode configurable over-ride function	3	Control word control	✓
Pump low load detection	✓	HMI support	✓	Auto reset	✓
Pump no-flow detection	✓	Supply loss detection	✓	Cloning	✓
Pump over-cycle protection	✓	Low DC link operation	✓	SD card adapter	✓
Pump cleaning function	✓	Analogue input control	2	SMARTCARD	✓
Hand/Off/Auto control	✓	Analogue output control	2	Acceleration rates	4
Pump volume monitoring	✓	Temperature monitoring	✓	Deceleration rates	4
Pump flow monitoring	✓	Digital input control	3	Skip frequency dead bands	✓
Pump Wake/sleep operation	✓	Digital output control	3	Guided set-up via 'Connect' commissioning software	✓
Pump flow switch input	✓	Relay control	3		
Pump assist over-cycle detection	✓	Motorised potentiometer	✓		
Auto-tune static	✓	Motorised potentiometer	✓		
Auto-tune rotating	✓	Logic function control	✓		
Catch a spinning motor	✓	Timer function control	✓		
Stop mode: Ramp	✓	Variable selector	✓		

# SPECIFICATION

## F600

Items supplied with the drive	Step-By-Step Guide, safety information, grounding bracket, grounding clamp, DC terminal cover grommets, terminal nuts, supply and motor connector, surface mounting brackets, control terminals, relay connectors, 24V power supply connector and finger guard grommets
Storage temperature	-40°C to 55°C, -40°F to 131°F
Operating temperature without de-rate	-20°C to 40°C, -4°F to 104°F
Operating temperature with de-rate	40°C to 55°C, 104°F to 131°F
Supply requirements	Maximum supply imbalance: 2% negative phase sequence (equivalent to 3% voltage imbalance between phases). Input frequency 45 to 66Hz
Switching frequency range	2,3,4,6,8,12,16kHz (Factory default = 3kHz)
Approvals	CE (European Union), cUL Listed (USA and Canada), RCM (Australia/ New Zealand), EAC (Russian Customs Union)
Product safety standard	EN61800-5-1
Functional safety (Dual STO function)	Functional safety (Single STO Function)
Altitude	1000m – No de-rate. 1000m to 3000m - 1% de-rate/100m
Humidity	95% Non-condensing
Pollution	Degree 2. Dry, non-conducting pollution only
IP Rating	IP20 – Pollution degree 2
Vibration	Reference standard IEC60068-2-29 bump test, IEC60068-2-64 random vibration test, IEC60068-2-6, EN61800-5-1 sinusoidal vibration test.
Mounting methods	Surface mount or through-panel mount via mounting brackets
Output frequency/speed range	599Hz
Braking	In-built braking transistor, external resistor required.
Operating modes	Open-loop, RFC-A (enhanced open-loop performance) RFC-S (permanent magnet motor)
Overload capability	110% for 165s from cold or for 9s from 100% load
Overvoltage category	Evaluated for OVC III.

<b>Corrosive environments</b>	Concentrations not exceeding levels set in: EN 50178:1998 Table A2 IEC 60721-3-3 Class 3C2
<b>Immunity Compliance</b>	IEC61800-3, EN60800-6-2, IEC 61000-4-2, IEC 61000-4-3, IEC61000-4-4, IEC61000-4-5, IEC61000-4-6, IEC61000-4-11, IEC61000-6-1, IEC 61000-6-2.
<b>Emission compliance</b>	Capable of meeting the requirements of Equipment Category C3 without external filters or line reactors. Capable of meeting the requirements of Equipment Category C2 when installed with the recommended filters and line reactors. IEC61800-3, EN61000-6-4, EN61000-3-2, EN61000-3-12, EN61000-3-3, EN12015
<b>Cooling</b>	Forced cooled
<b>Safe Torque off</b>	Single STO. SIL 3
<b>Communications*</b>	RS485, MODBUS RTU, PROFIBUS, Ethernet, EtherCAT, DeviceNET, CANopen and PROFINET (via SI Option modules)
<b>Control I/O</b>	2 x analog input, 2 x analog outputs, 3 x Digital I/O programmable, 3 x Digital input, 2 x NO relay 250Vac Max., 5 x 0V common, 1 x 24V user output, 1 x 24V external input, 1 x STO input. Additional I/O available with SI-I/O option module.
<b>Accuracy</b>	Frequency 0.01%, Analogue input 1 and 2: 11 bits plus sign, Current accuracy typical 2%.
<b>On-Board user program capability</b>	N/A
<b>Keypad (LCD)</b>	KI- HOA keypad RTC (real time clock), HOA Remote keypad
<b>PC Tools</b>	'Connect' commissioning and cloning tool including CT Oscilloscope, Machine Control Studio for On-board PLC programming.
<b>Warranty</b>	5 years
<b>Supported options</b>	RTC Remote Keypad, HMI, SI-PROFIBUS, SI-Ethernet, SI- EtherCAT, SI-DeviceNET, SI-CANopen, SI-PROFINET, SI-I/O, SI-Encoder (speed feedback), Remote I/O, MCI 200 (2nd processor), KI-485 comms adapter, SD card adapter and SMARTCARD.
<b>Accessories</b>	Through-hole IP65 (frame 3 to 8) or IP55 (frame 9 to 11) mounting kits, UL type conduit kits, retrofit mounting brackets, external EMC filters and grounding bracket (supplied with the drive)

## Documentation & Downloads

Product documentation and PC tools available for download from:  
[www.controltechniques.com/support](http://www.controltechniques.com/support)

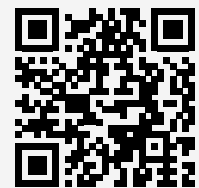

# DIMENSIONS

Frame Size	Overall Dimensions						Mounting Dimensions				Mounting Hole Diameter		Weight	
	mm			in			mm		in		mm	in	kg	lb
	H	W	D	H	W	D	H	W	H	W				
3	382	83	200	15.03	3.26	7.87	365	73	14.37	2.87	5.5	0.21	4.5	9.92
4	391	124	200	15.39	4.88	7.87	365	106	14.37	4.17	6.5	0.26	6.5	14.33
5	391	143	200	15.39	5.63	7.87	365	106	14.37	4.17	6.5	0.26	7.4	16.3
6	391	210	287	15.39	8.27	11.29	365	196	14.37	7.72	7	0.28	14	30.9
7	552	270	280	21.73	10.63	11.02	508	220	20	8.66	9	0.35	28	61.70
8	804	310	290	31.65	12.21	11.42	753	259	29.64	10.20	9	0.35	52	114.6
9	1108	320	290	43.62	12.59	11.42	1049	259	41.29	10.20	9	0.35	46	101.4
10	1069	310	290	42.08	12.21	11.42	1010	259	39.76	10.20	9	0.35	46	101.4
11	1242	310	313	48.89	12.21	12.32	1189	259	46.81	10.20	9	0.35	63	138.8



# CONNECTIONS

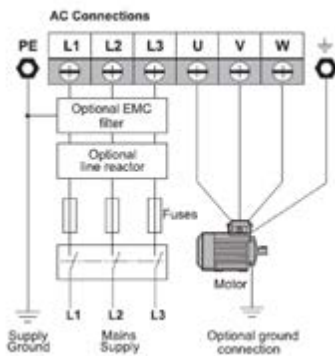

Typical Power Connections

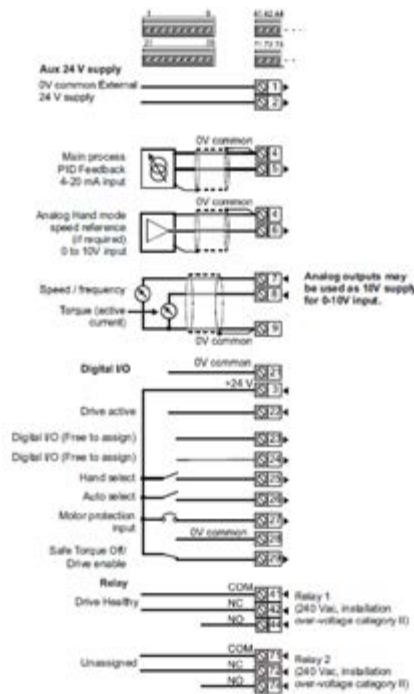

Default Control Connections

# PART NUMBERS

<b>F600</b>	<b>03</b>	<b>4</b>	<b>00078</b>	<b>A</b>	<b>1</b>
⋮	⋮	⋮	⋮	⋮	⋮
<b>Model:</b>	<b>Frame Size</b>	<b>Voltage Rating:</b>	<b>Current Rating x 10</b>	<b>Drive Format</b>	<b>Configuration</b>
F600	1 to 11	2 = 200V (200V-240 +/-10%) 4 = 400V (380V-480V +/-10%) 5 = 575V (500V-575V +/-10%) 6 = 690V (500V-690V +/-10%)		A = AC in AC out E = AC in AC out, external line reactor	1 = Standard U = No control M = Master F = Follower

\*A designation with internal choke is everything below and including Frame size 9

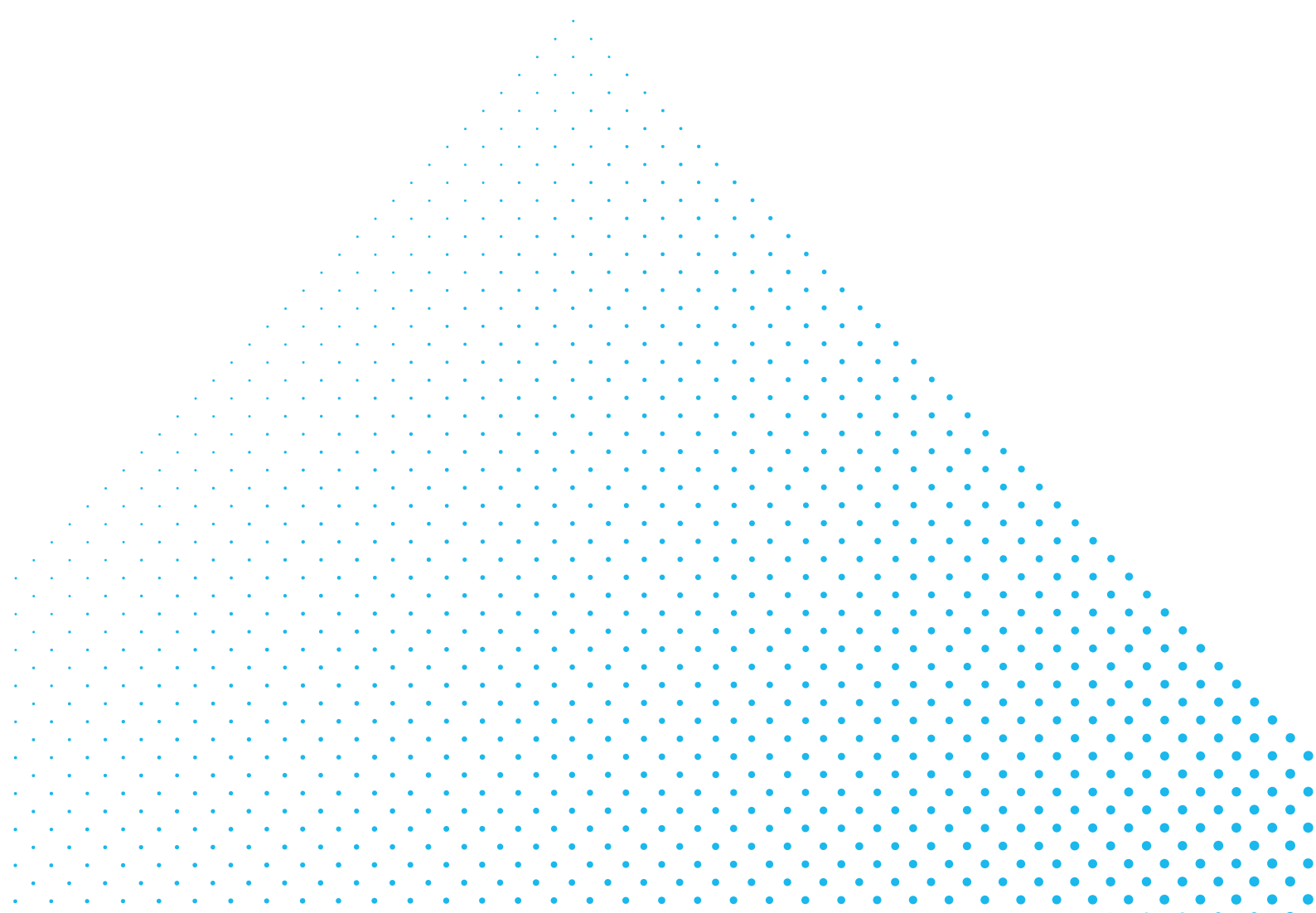

# MODEL NUMBER AND RATINGS

Model No.	Normal Duty		
	Max continuous current (A)	Motor shaft power (kW)	Motor shaft power (hp)
200/240 Vac $\pm$ 10%			
F600-03200066A10	6.6	1.1	1.5
F600-03200080A10	8	1.5	2
F600-03200110A10	11	2.2	3
F600-03200127A10	12.7	3	3
F600-04200180A10	18	4	5
F600-04200250A10	25	5.5	7.5
F600-05200300A10	30	7.5	10
F600-06200500A10	50	11	15
F600-06200580A10	58	15	20
F600-07200750A10	75	18.5	25
F600-07200940A10	94	22	30
F600-07201170A10	117	30	40
F600-08201490A10	149	37	50
F600-08201800A10	180	45	60
F600-09202160A10	216	55	75
F600-09202660A10	266	75	100
F600-09202160E10	216	55	75
F600-09202660E10	266	75	100
F600-10203250E10	325	90	125
F600-10203600E10	360	110	150

Model No.	Normal Duty		
	Max continuous current (A)	Motor shaft power (kW)	Motor shaft power (hp)
<b>380/480 Vac ±10%</b>			
F600-03400034A10	3.4	1.1	1.5
F600-03400045A10	4.5	1.5	2
F600-03400062A10	6.2	2.2	3
F600-03400077A10	7.7	3	5
F600-03400104A10	10.4	4	5
F600-03400123A10	12.3	5.5	7.5
F600-04400185A10	18.5	7.5	10
F600-04400240A10	24	11	15
F600-05400300A10	30	15	20
F600-06400380A10	38	18.5	25
F600-06400480A10	48	22	30
F600-06400630A10	63	30	40
F600-07400790A10	79	37	50
F600-07400940A10	94	45	60
F600-07401120A10	112	55	75
F600-08401550A10	155	75	100
F600-08401840A10	184	90	125
F600-09402210A10	221	110	150
F600-09402660A10	266	132	200
F600-09402210E10	221	110	150
F600-09402660E10	266	132	200
F600-10403200E10	320	160	250
F600-10403610E10	361	200	300
F600-11404370E10	437	225	350
F600-11404870E10	487	250	400
F600-11405070E10	507	280	450
F600-12404800TU0	608	315	500
F600-12405660TU0	660	355	550
F600-12406600TU0	755	400	650
F600-12407200TU0	865	500	700

Drive	Normal Duty		
	Max continuous current (A)	Motor shaft power (kW)	Motor shaft power (hp)
<b>500/575 Vac ±10%</b>			
F600-05500039A10	3.9	2.2	3
F600-05500061A10	6.1	4	5
F600-05500100A10	10	5.5	7.5
F600-06500120A10	12	7.5	10
F600-06500170A10	17	11	15
F600-06500220A10	22	15	20
F600-06500270A10	27	18.5	25
F600-06500340A10	34	22	30
F600-06500430A10	43	30	40
F600-07500530A10	53	37	50
F600-07500730A10	73	45	60
F600-08500860A10	86	55	75
F600-08501080A10	108	75	100
F600-09501250A10	125	90	125
F600-09501550A10	155	110	150
F600-09501250E10	125	90	125
F600-09501500E10	150	110	150
F600-10502000E10	200	130	200
F600-11502480E10	248	175	250
F600-11502880E10	288	225	300
F600-11503150E10	315	250	350



Drive	Normal Duty		
	Max continuous current (A)	Motor shaft power (kW)	Motor shaft power (hp)
<b>500/690 Vac ±10%</b>			
F600-07600230A10	23	18.5	25
F600-07600300A10	30	22	30
F600-07600360A10	36	30	40
F600-07600460A10	46	37	50
F600-07600520A10	52	45	60
F600-07600730A10	73	55	75
F600-08600860A10	86	75	100
F600-08601080A10	108	90	125
F600-09601250A10	125	110	150
F600-09601500A10	150	132	175
F600-09601250E10	125	110	150
F600-09601550E10	155	132	175
F600-10601720E10	172	160	200
F600-10601970E10	197	185	250
F600-11602250E10	225	200	250
F600-11602750E10	275	250	300
F600-11603050E10	305	280	400

\* Rating at 2kHz











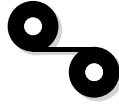

# SERVO DRIVES AND MOTORS

**DIGITAX**

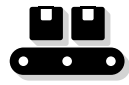
# PRODUCTS IN THIS RANGE

DIGITAX HD | UNIMOTOR HD | DIGITAX SF

## DIGITAX Applications:

- |   |             |   |  |   |                    |
|---|-------------|---|--|---|--------------------|
|    | Hoists      |    | Winding  |    | Cutting            |
|   | Woodworking |   | Printing   |   | Web Handling       |
|  | Textiles    |  | Packaging Machines   |  | Tyre Manufacturing |
|  | Extrusion   |  | Metals   |  | Mining             |
|  | Marine      |  | <b>Speed &amp; Position Control</b><br>(For Gearing & Ratio Control) |   |                    |



# DIGITAX HD

# MINIMUM SIZE

# MAXIMUM

# PERFORMANCE

1.5 A – 16 A with 48 A peak | 200 V | 400 V | 0.25 kW - 7.5 kW  
Amps | Power | Voltage

Downsize cost and upsize floor space.

With a tiny footprint but exceptional power density, Digitax HD is one of the smallest servo drives on the market today. Build the most compact cabinets possible.

## The market's narrowest servo drive

- Digitax HD is just 40mm (1.6 in) wide
- 25 drives, up to 16A per drive, can fit in just 1 metre (40 in) of cabinet space

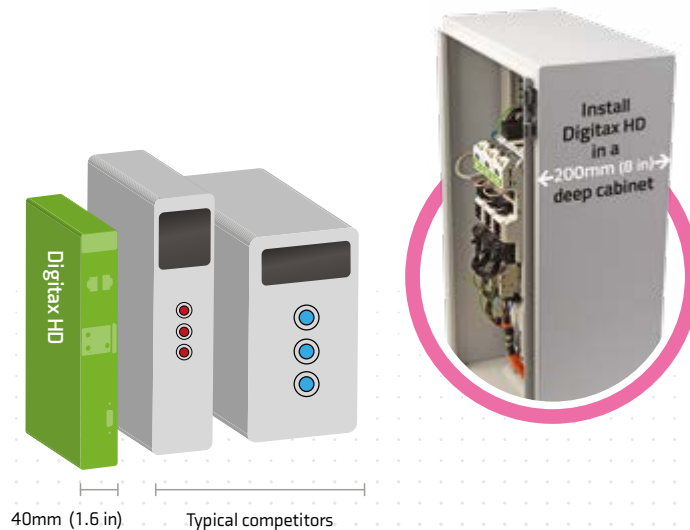

Actual size



Just 40 mm (1.6 in)

# KEY SERVO FEATURES

Servo Series		M753 EtherCAT	M751 Base	M750 EtherNet	M754 MCI
Interface	Onboard Communications	2-port EtherCAT switch	2-port RS485	2-port EtherNet switch	2-port EtherNet switch
	Fieldbus	EtherCAT	Modbus RTU	Modbus TCP/IP, EtherNet/IP, PROFINET RT	Modbus TCP/IP
	Real Time Motion	EtherCAT (CoE)	None	RTMoE	RTMoE
	Analog I/O	1 Analog Input ± 10V, 12 bits (11 bits + sign)			
	Digital I/O	2 DI, 2 DO (100 mA), 1 motor brake output (1 A, max 1.3 A)			
	Pulse Train Input	Frequency/Direction 5 V differential, 500 kHz			
	Encoder Feedback	2 x Encoder input and 1 simulated encoder output			
	Supported Encoders	Resolver, Quadrature, AB Servo, SinCos, EnDat (2.1/2.2), SSI, BiSS, Hiperface			
	Safety	2 x Safe Torque Off (STO) via terminal, PLe, SIL3			
Control	Motor Control Modes	V/F, Open loop vector, Rotor flux control-Asynchronous for induction motors (Sensorless or with feedback 'Closed Loop'), Rotor flux control-Synchronous (Sensorless or with feedback 'Closed Loop')			
	Control Modes	Position control, speed control, torque control			
	Control Features	Stationary autotune for permanent magnet motors Advanced bi-quad filters for suppression of mechanical resonances			
Onboard Intelligence	Motion	Advanced Motion Controller			MCI
		Parameterised motion			Programmable motion
		1.5 Axes			Up to 5 Axes
	Positioning digital lock control			Positioning digital lock control camming	
	PLC	Real-time tasks Onboard PLC			Onboard Machine Controller
Performance	Update Rates	Current Loop Update: 62 µs			
		Speed Loop Update: 250 µs			
		Position Loop Update: 250 µs			
	Overload	*Closed-loop Overload: Maximum closed loop peak current for 0.25 s (from cold: 300 % for 8 s or 200 % for 60 s) *Open-loop Overload: Maximum open loop peak current for 8 s (from cold: 150 % for 100 s)			
	Max Output Frequency	550 Hz (RFC-A and RFC-S) 599 Hz (Open Loop)			
Switching Frequency	Configurable range: 2, 3, 4, 6, 8, 12, 16 kHz Default: 8kHz				

RFC-S: Rotor Flux Control for Synchronous (permanent magnet brushless) motors

RFC-A: Rotor Flux Control for Asynchronous (induction) motors

\* The stated percentages apply only to three phase continuous current

# SPECIFICATION

## Digitax HD

Items supplied with the drive	Documents: Quick Start Guide, Safety Information Booklet, Certificate of Quality. Accessories: Power input connector, Brake connector, I/O connector, 24 Vdc supply connector, cable screen bracket, 3 x M4x8 screws (motor earth, supply earth, cable screen bracket), motor connector.
Storage temperature	-40°C to 55°C (-40°F to 131°F)
Operating temperature without de-rate	-20°C to 40°C (-4°F to 104°F)
Operating temperature with de-rate	40°C to 55°C (104°F to 131°F)
Supply requirements	200 V to 240 V ± 10% single or three phase. 380 V to 480 V ± 10% three phase.
Switching frequency range	2,3,4,6,8,12,16 kHz (Factory default = 8 kHz)
Approvals	CE (European Union), cUL Listed (USA and Canada), KC (Korea), RCM (Australia/ New Zealand), EAC (Russian Customs Union)
Product safety standard	EN61800-5-1
Functional safety (single STO function)	Independently assessed by TUV to IEC 61800-5-2 SIL 3 and EN ISO 13849-1 PL
Altitude	1000 m to 3000 m (3300 ft to 9900 ft). 1% de-rate per 100 m (330 ft) above 1000 m (3300 ft)
Humidity	95% Non-condensing at 40°C (104°F)
Pollution	Degree 2. Dry, non-conducting pollution only
IP Rating	IP20 – Pollution degree 2
Vibration	Maximum recommended continuous (random) vibration level 0.14 g r.m.s. broadband 5 to 200 Hz. Reference standard IEC60068-2-27 (bump test), IEC60068-2-64 (random vibration test), IEC60068-2-6, EN61800-5-1 (sinusoidal vibration test). Tested to Environmental Category ENV3.
Mounting methods	Horizontal or vertical surface mounting with DIN rail alignment.
Output frequency/speed range	550 Hz (RFC-A/RFC-S); 599 Hz (Open loop)
Braking	In-built braking transistor, external resistor required (drive mountable resistor or external resistor)
Operating modes	Open-loop, RFC-A (enhanced open-loop performance), RFC-S (servo mode)
Overload capability	Open-loop (from cold) 150 % for 100 s, Open-loop (from 100%) 150 % for 8 s. RFC (from cold) 300% for 8 s, RFC (from 100%) 300% for 0.25 s
Overvoltage category	Evaluated for OVC III.
Corrosive environments	Concentrations of corrosive gases must not exceed the levels given in: Table A2 of EN 50178:1998, Class 3C2 of IEC 60721-3-3 This corresponds to the levels typical of urban areas with industrial activities and/or heavy traffic, but not in the immediate neighbourhood of industrial sources with chemical emissions.

<b>Immunity Compliance</b>	IEC61800-3, IEC 61000-4-2, IEC 61000-4-3, IEC61000-4-4, IEC61000-4-5, IEC61000-4-6, IEC61000-4-8, IEC61000-4-11, IEC61000-6-1, IEC 61000-6-2.
<b>Emission compliance</b>	Capable of meeting the requirements of Equipment Category C3 without external filters or line reactors. Capable of meeting the requirements of Equipment Category C1 when installed with the recommended filters (dependant on switching frequency). EN61000-6-2, EN61000-6-4, EN61000-3-2, EN61000-3-3
<b>Cooling</b>	Ultraflow™ rear venting option available
<b>Safe Torque off</b>	Dual STO channels. SIL3/PLC compliant
<b>Communications</b>	M750 – EtherNet (multiprotocol) M751 – RS-485 M753 – EtherCAT M754 – EtherNet SI Options – EtherCAT, PROFIBUS, Ethernet, DeviceNet, CANopen, PROFINET V2
<b>Control I/O</b>	1 x Analogue input, 2 x Digital input, 2 x Digital output, 1 x Motor brake output, 7 x 0 V common, 1 x 24V user output. Pluggable control connector with push in spring connection. (Additional I/O available with SI-I/O option module). 2 x External 24 Vdc User supplied ports for control supply. Pluggable connector with screw connection.
<b>Accuracy</b>	Frequency 0.01%, Analog input 1: 11 bit plus sign. Current typical 2%.
<b>On-Board advanced motion controller</b>	Advanced 1.5 axes Motion Controller, key features include: – Real-time tasks – 250 µs cycle time – Motion profile generator – Electronic gearbox – Interpolated CAM – Homing functions – High speed position freeze
<b>Keypad</b>	Single 7 segment display with 2 x rotary dials for node address setting. Remote keypad with Real-time clock available as option (Optional on M751).
<b>Parameter backup and cloning</b>	Smartcard and SD card (using SD card adapter)
<b>PC Tools</b>	'Connect' commissioning and cloning tool including CT Oscilloscope, Machine Control Studio for On-board PLC programming.
<b>Warranty</b>	2 years
<b>Supported options</b>	SI-EtherCAT, SI-PROFIBUS, SI-Ethernet, SI-DeviceNET, SI-CANopen, SI-PROFINET, SI-I/O, SI-Encoder (speed feedback), Remote I/O, SI-Powerlink, SI-Universal Encoder, MCI200, MCI210, SI-Apps Compact and PTi210.
<b>Accessories</b>	Rear vent, Compact brake resistor & External brake resistors, Encoder breakout connector, KI-485 adaptor, KI compact display (supplied with M750, M753, and M754 Drives), Digitax ST retrofit brackets, SI-Option module mounting kit. External EMC filters, Fan replacement kits, Remote Keypad RTC, Multi-axis kits (24Vdc link, DC bus link, Comms link), Unidrive M to Digitax HD DC busbar adaptor kits, Capacitor Module to extend DC bus capacity and Cable grommet kit.

## Documentation & Downloads

Product documentation and PC tools available for download from:  
[www.controltechniques.com/support](http://www.controltechniques.com/support)

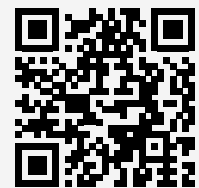

# DIMENSIONS

Frame Size	Overall Dimensions						Mounting Dimensions				Mounting Hole Diameter		Weight	
	mm			in			mm		in		mm	in	kg	lb
	H	W	D	H	W	D	H	W	H	W				
1	233	40	174	9.17	1.58	6.85	222	12	8.74	0.47	5.2	0.21	1.9	4.2
2	278	40	174	10.95	1.58	6.85	267	12	10.51	0.47	5.2	0.21	2.3	5.1
3	328	40	174	12.91	1.58	6.85	317	12	12.48	0.47	5.2	0.21	2.5	5.5



# CONNECTIONS

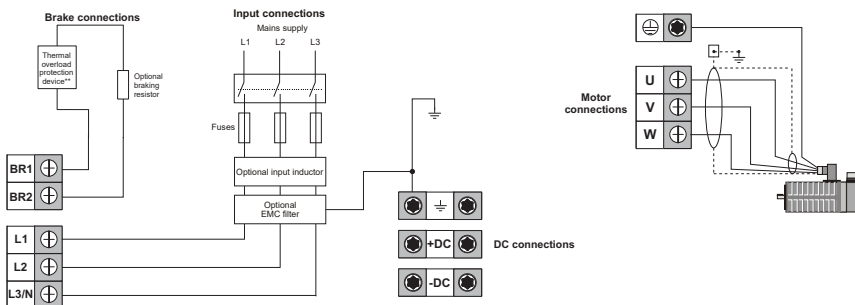

Typical Power Connections

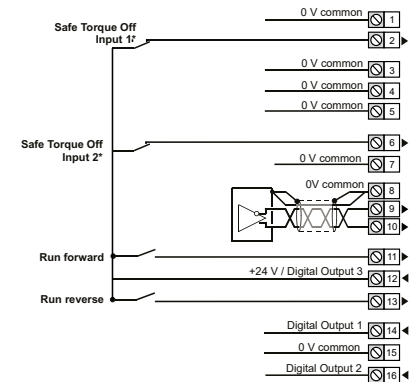

Default Control Connections



# PART NUMBERS

<p><b>M751</b></p> <p>⋮</p> <p><b>Model:</b>                  M750 (Ethernet)                  M751 (RS-485)                  M753 (EtherCAT)                  M754 (MCi)</p>	<p><b>03</b></p> <p>⋮</p> <p><b>Frame Size</b>                  1 to 3</p>	<p><b>4</b></p> <p>⋮</p> <p><b>Voltage Rating:</b>                  2 = 200V (200V-240 +/-10%)                  4 = 400V (380V-480V +/-10%)</p>	<p><b>00022</b></p> <p>⋮</p> <p><b>Current Rating:</b>                  Heavy Duty x10</p>	<p><b>A</b></p> <p>⋮</p> <p><b>Drive Format</b>                  A = AC in AC out</p>
---	--	---	--	---

# MODEL NUMBER AND RATINGS

200 V Single Phase							
Frame Size W x D x H mm (in)	Frame Size 01 40 x 174 x 233 (1.57 x 6.85 x 9.17)	Frame Size 02 40 x 174 x 278 (1.57 x 6.85 x 10.94)	Frame Size 03 40 x 174 x 328 (1.57 x 6.85 x 12.91)				
Line Supply	Single Phase AC 200 V...240 V (± 10%) @ 45...66 Hz						
	M75X-...	01200022	01200040	01200065	02200090	02200120	03200160
<b>Output Servo</b>							
Rated Current (A)	1.1	2.2	3.5	5.6	7.5	10.8	
Max Peak Current (A)	6.6	12	19.5	27	36	48	
<b>Output AC Induction</b>							
Max Continuous Current (A)	1.1	2.2	3.5	5.6	7.5	10.8	
Open Loop Peak Current (A)	3.3	6	9.8	13.5	18	24	
Closed Loop Peak Current (A)	6.6	12	19.5	27	36	48	
Motor Power at 230 V (kW)	0.18	0.37	0.75	1.1	1.5	2.2	
Motor Power at 230 V (hp)	0.25	0.5	1.0	1.5	2.0	3.0	
<b>Overload</b>							
Closed-loop Overload	Maximum closed loop peak current for 0.25 s						
Open-loop Overload	Maximum open loop peak current for 8 s						

200 V Three Phase								
Frame Size W x D x H mm (in)	Frame Size 01 40 x 174 x 233 (1.57 x 6.85 x 9.17)			Frame Size 02 40 x 174 x 278 (1.57 x 6.85 x 10.94)			Frame Size 03 40 x 174 x 328 (1.57 x 6.85 x 12.91)	
Line supply	Three Phase AC 200 V...240 V (± 10%) @ 45...66 Hz							
	M75X-...	01200022	01200040	01200065	02200090	02200120	03200160	
<b>Input</b>								
Max Power (kW)	4			5.3			10*	
<b>Output Servo</b>								
Rated Current (A)	2.2	4	6.5	9	12	16		
Max Peak Current (A)	6.6	12	19.5	27	36	48		
<b>Output AC Induction</b>								
Max Continuous Current (A)	2.2	4	6.5	9	12	16		
Open Loop Peak Current (A)	3.3	6	9.8	13.5	18	24		
Closed Loop Peak Current (A)	6.6	12	19.5	27	36	48		
Motor Power at 230 V (kW)	0.37	0.75	1.1	2.2	2.2	4.0		
Motor Power at 230 V (hp)	0.5	1.0	1.5	2.0	3.0	5.0		
<b>Overload</b>								
Closed-loop Overload	300 % for 0.25 s or 200 % for 4 s							
Open-loop Overload	150 % for 8 s							

400 V Three Phase									
Frame Size W x D x H mm (in)	Frame Size 01 40 x 174 x 233 (1.57 x 6.85 x 9.17)			Frame Size 02 40 x 174 x 278 (1.57 x 6.85 x 10.94)			Frame Size 03 40 x 174 x 328 (1.57 x 6.85 x 12.91)		
Line supply	Three Phase AC 380 V...480 V (± 10%) @ 45...66 Hz								
	M75X-...	01400015	01400030	01400042	02400060	02400080	02400105	03400135	03400160
<b>Input</b>									
Max Power (kW)	6.5			8.7			10/13*		
<b>Output Servo</b>									
Rated Current (A)	1.5	3	4.2	6	8	10.5	13.5	16	
Max Peak Current (A)	4.5	9	12.6	18	24	31.5	40.5	48	
<b>Output AC Induction</b>									
Max Continuous Current (A)	1.5	3	4.2	6	8	10.5	13.5	16	
Open Loop Peak Current (A)	2.3	4.5	6.3	9	12	15.8	20.3	24	
Closed Loop Peak Current (A)	4.5	9	12.6	18	24	31.5	40.5	48	
Motor Power at 400 V (kW)	0.37	0.75	1.5	2.2	3.0	4.0	5.5	5.5	
Motor Power at 400 V (hp)	0.75	1.5	2.0	3.0	5.0	5.0	7.5	10.0	
<b>Overload</b>									
Closed-loop Overload	300 % for 0.25 s or 200 % for 4 s								
Open-loop Overload	150 % for 8 s								

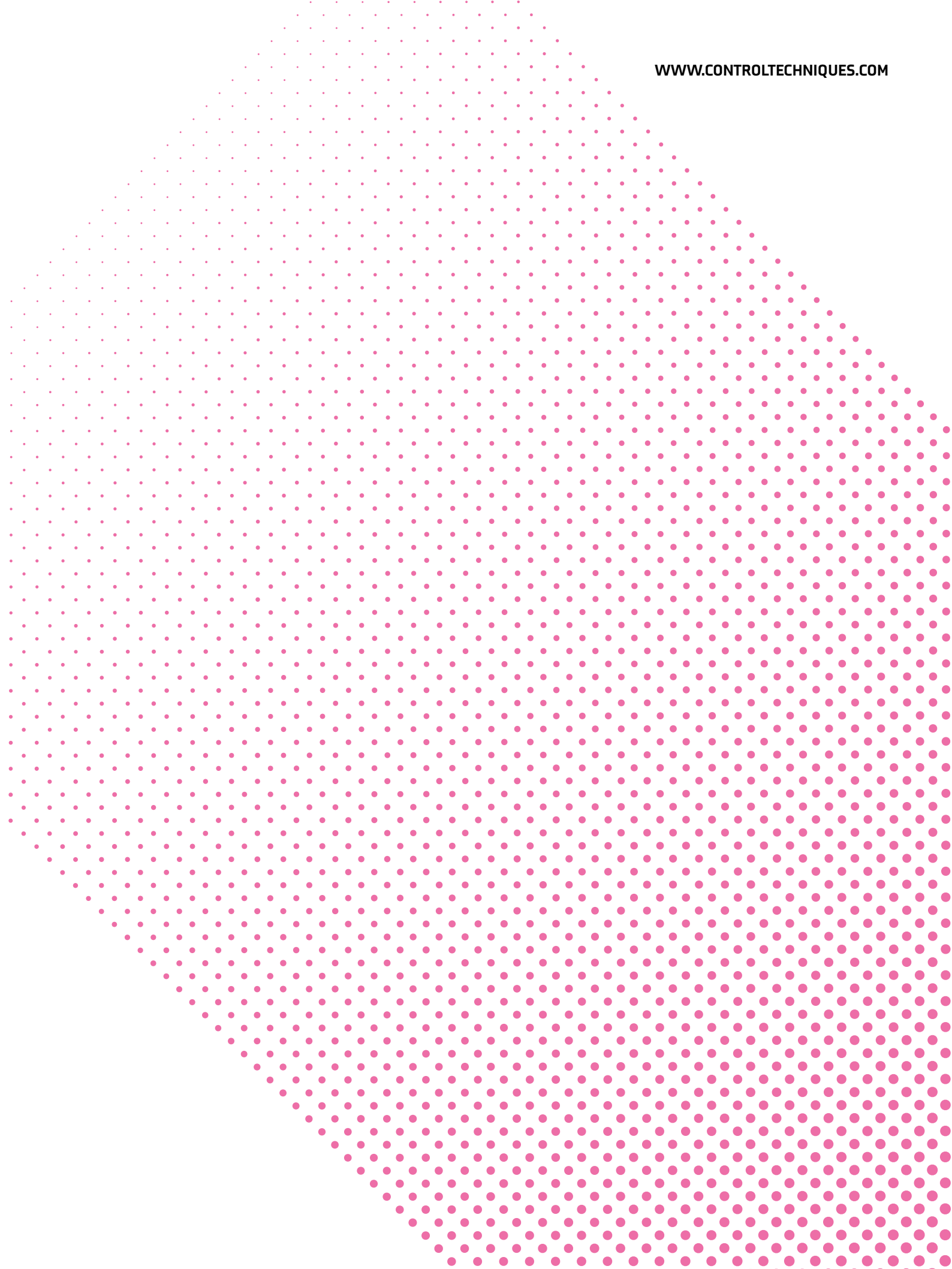

# DIGITAX SF

# EASY TO USE LOW POWER SERVO

0.05 kW - 2 kW | 200 V

The perfect choice for low powered precision servo solutions with its dedicated servo range from 50W to 2 kW.

With 17-bit resolution, robust magnetic encoder technology and pulse train or analogue control interface, Digitax SF offers a cost effective servo solution, without compromising on performance.

## Key Benefits:

- Magnetic encoder technology
- Versatile analogue or pulse train interface
- Built-in keypad
- Standalone operation
- PC-USB interface
- Multiple motor inertia levels available



DIGITAX SF DRIVE

# KEY DRIVE FEATURES

Function		Function	
Operation mode: Position	✓	Command Mode: Pulse Train (Position)	✓
Operation mode: Velocity	✓	Command Mode: Analog (Velocity, Torque)	✓
Operation mode: Torque	✓	Command Mode: Internal (Position, Velocity)	✓
Pulse train input pulse form: Pulse/Direction	✓	Pulse train input pulse form: Quadrature Encoder Pulse	✓
Pulse train input pulse form: CCW/CW	✓	Analog Input Filter	✓
Position Command Filter	✓	Torque Limit	✓
Torque Command Filter	✓	Inching	✓
Jog	✓	Supply loss detection	✓
Bi-polar analog reference	✓	Analogue input control	✓
Internal Pre-set speeds	8	Homing to sensor	✓
Internal Point Moves	16	Homing to encoder z-pulse	✓
Homing to torque limit/stopper	✓	Temperature monitoring	✓
Acceleration Rates (Mode Dependent)	1 to 16	Digital input control	✓
Deceleration Rates (Mode Dependent)	1 to 16	Digital output control	✓
Command pulse frequency RS-422 max	4Mpps	Limit switch control	✓
Command pulse frequency open-collector max	200kpps	Analog Input filters	✓
Auto-tune rotating	✓	Pulse train input filter	✓
Energy meter	✓	Run time log	✓
Alarm time stamping	✓	Alarm logging	10
Auto reset	✓	Control word control	✓
Cloning	✓	Mechanical brake controller	✓
Stop mode: Coast	✓	Stop Mode: Emergency Stop Brake	✓
Stop mode: Quick Stop	✓	Stop mode: Short Brake	✓

# SPECIFICATION

## Digitax SF

Items supplied with the drive	Safety information, power input connector, encoder connector
Storage temperature	-20°C to 65°C, -4°F to 149°F
Operating temperature without de-rate	0°C to 50°C, 32°F to 122°F
Operating temperature with de-rate	N/A
Supply requirements	Maximum supply imbalance: 2 % negative phase sequence (equivalent to 3 % voltage imbalance between phases). Input frequency 45 to 66Hz
Switching frequency range	N/A
Approvals	CE (European Union), UL (508C if installed in appropriate environment), KC (Korea)
Product safety standard	EN61800-5-1
Functional safety (Dual STO function)	N/A
Altitude	≤1000m
Humidity	20 – 85% RH or less (Non-condensing)
Pollution	Degree 2. Dry, non-conducting pollution only
IP Rating	IPXX – Pollution degree 2
Vibration	≤5.8m/s (0.6G) 10 to 60Hz (no continuous operation allowed at resonant frequency)
Mounting methods	Surface mount, mounting holes only
Output frequency/speed range	0 - 500Hz (50W - 750W), 0 – 250Hz (1kW – 2kW)
Braking	Mechanical brake control, no internal braking resistor but an external emergency stop braking unit can be fitted
Operating modes	Position, Velocity, Torque
Overload capability	350% (50W to 100W), 300% (200W to 2kW)
Overvoltage category	II
Corrosive environments	Never use the product in an environment containing explosive or flammable gases, chloride, acidic or alkaline corrosive environment such as sulfur dioxide, chlorine, ammonia and so on
Immunity Compliance	EN 61000-6-2:2005
Emission compliance	EN55011:2009+A1:2010

Cooling	Forced cooled
Safe Torque off	None
Communications	RS-485
Control I/O	1 x Analogue Input, 1 x Analog Ground 8 x Digital Input Programmable, 6 x Digital Output, 2 x independent digital output, 1 x Control 24V Power Input, 1 x Control Ground, 1 x I/O COM +, 1 X I/O COM-, 7 x simulated encoder output, 3 x RS485 terminals, 8 x Position Pulse Inputs
Accuracy	Command pulse -paired ratio: 1/1000 < A/B < 1000, Analogue input: Single Ended ±10V
On-Board user program capability	N/A
Keypad	Fixed LED keypad
PC Tools	'Digitax SF Connect' commissioning, waveform monitor and point table setup.
Warranty	
Supported options	N/A
Accessories	Input / Output (I/O) terminal block and cable assembly; Input / Output Interface Connector; Surge absorber / protector; EMC filter
Encoder	17-bit single or multi-turn (incremental)
Encoder Multi-turn count	65536

# DIMENSIONS

Frame Size	Overall Dimensions						Mounting Dimensions				Mounting Hole Diameter		Weight	
	mm			in			mm		in		mm	in	kg	lb
	H	W	D	H	W	D	H	W	H	W				
1	160	40	130	6.3	1.57	5.12	150	30	5.91	1.18	5.5	0.22	0.7	1.54
2	160	48	130	6.3	1.89	5.12	150	30	5.91	1.18	5.5	0.22	0.8	1.76
3	160	68	130	6.3	2.68	5.12	150	44	5.91	1.73	5.5	0.22	1	2.2
4	160	84	130	6.3	3.31	5.12	150	61.7 / 69*	5.91	2.72 / 2.43	5.5	0.22	1.6	3.53

\* Mounting hole separation: 61.7mm at the top, 69mm at the bottom



# CONNECTIONS

## Typical Power Connections

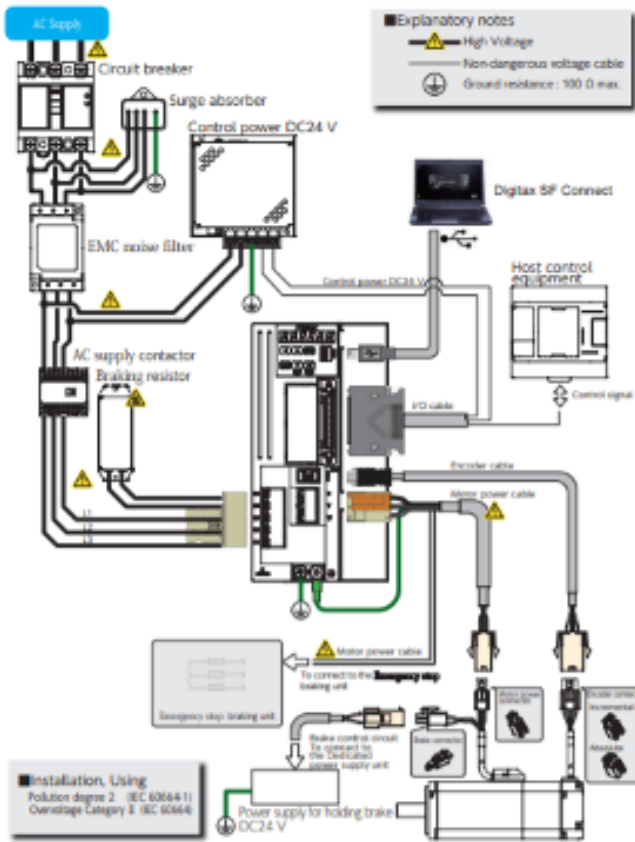

## Default Control Connections

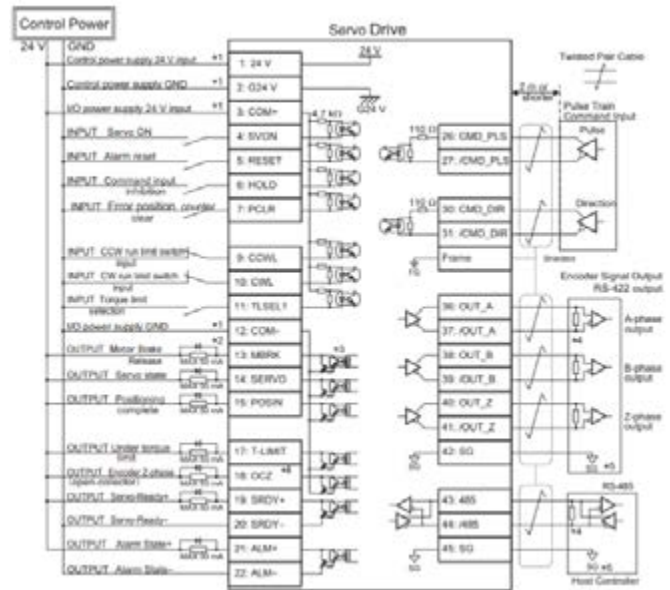

## Pulse Train Command

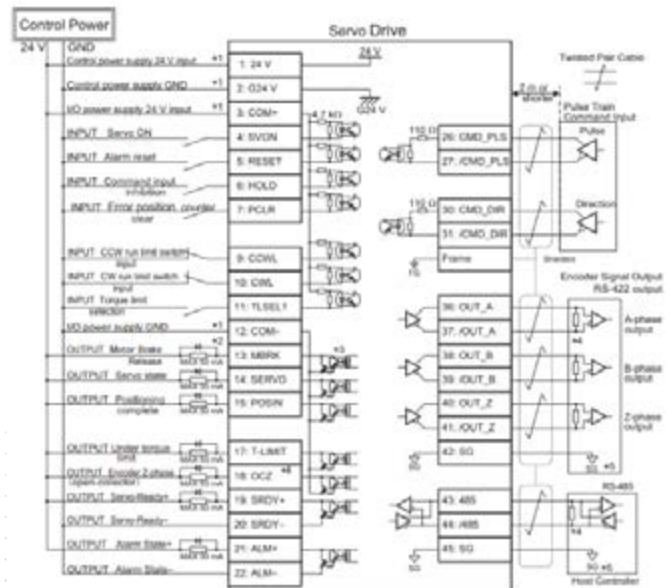

## Analog Velocity Command



# PART NUMBERS

<p><b>DA</b></p> <p>⋮</p> <p>Series</p>	<p><b>2</b></p> <p>⋮</p> <p><b>Input Power Supply:</b> 2: AC 200V-240V (50W - 750W: Single-phase) 1kW: Single-phase/three-phase 1.5kW, 2kW: Three-phase</p>	<p><b>Y</b></p> <p>⋮</p> <p><b>Compatible Motor:</b> Y: Mx500x2xx, Z: Mx101x2xx 1: Mx201x2xx, 2: Mx401x2xx 3: Mx751x2xx, 4: Mx102x2xx 6: Mx152x2xx, 8: Mx202x2xx</p>	<p><b>Z</b></p> <p>⋮</p> <p><b>Main Circuit Power Supply:</b> Z: 50W, 1: 100W, 2: 200W, 4: 400W, 8: 750W, A: 1kW, B: 1.5kW, C: 2kW</p>
---	---	--	--

# MODEL NUMBER AND RATINGS

Model No.	Frame Size	Supply Phases	Rated Current (A)	Motor Power (kW)	Motor Power (hp)	Compatible Motor		
						Model No.	Motor Flange Size (mm)	Motor Inertia
<b>200V (200-240V +/-10%)</b>								
DA2YZ	1	1	0.7	0.05	0.07	Mx500x2xx	40	Middle
DA2Z1	1	1	1	0.1	0.13	Mx101x2xx	40	Middle
DA212	1	1	1.7	0.2	0.27	Mx201x2xx	60	Low,High
DA224	1	1	2.7	0.4	0.53	Mx401x2xx	60	Low,High
DA238	2	1	4.3	0.75	1	Mx751x2xx	80	Low,High
DA24A	3	01-Mar	5.6	1	1.3	Mx102x2xx	130	Middle,High
DA26B	4	3	9.9	1.5	2	Mx152x2xx	130	Middle,High
DA28C	4	3	12.2	2	2.7	Mx202x2xx	130	Middle

## Documentation & Downloads

Product documentation and PC tools available for download from:  
[www.controltechniques.com/support](http://www.controltechniques.com/support)

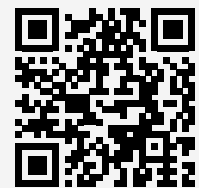

# DIGITAX SF MOTOR

# SPECIFICATION

## Digitax SF Motor

Ambient temperature for operation	0 to 40°C
Ambient humidity for operation	20 to 85% RH (no condensation)
Ambient temperature for storage	-20 to 65°C (no condensation)
	(not subjected to direct sunlight) 80°C for 72 hours
Ambient humidity for storage	20 to 85% RH (no condensation)
Atmosphere for operation/storage	Indoors (not subject to direct sunlight)
	Free from corrosive gases, flammable gases, oil mist, dust, flammables, grinding fluid
Insulation resistance	≥5MΩ at 1,000VDC
Dielectric strength	AC 1500V for one minute across the primary Ground/Earth FG
Operating altitude	≤1000m
Vibration class	V15 (JEC2121)
Vibration resistance	49m/s <sup>2</sup> (5G)
Impact resistance	98m/s <sup>2</sup> (10G)
Protective structure	IP65: 50W to 750W
	IP67: 1kW to 2kW
Electric shock protection	Class I (Mandatory grounding)
Overvoltage category	II
Installation environment	Pollution degree 2

## Documentation & Downloads

Product documentation and PC tools available for download from:  
[www.controltechniques.com/support](http://www.controltechniques.com/support)

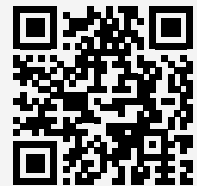

Digitax SF Encoder	Mxxxxx2xN	Mxxxxx2xA
Resolution	Incremental 17-bit	Absolute 17-bit
Ambient operating temperature	0 to 85°C	
External disturbance magnetic field	±2mT (20G) or below	
Power supply voltage	DC 4.5 to 5.5V (Power supply ripple ≤5%)	
Power supply current consumption	160mA (Not including inrush current)	
External battery voltage	-	DC 2.4 to 4.2V
External battery current consumption	-	10µA
Multi-turn count	-	65,536 counts
Maximum revolving speed	6,000rpm	
Count-up direction	Counter-clockwise viewed from load-side shaft end	
Input/output type	Differential	
Communication transmission method	Half-duplex asynchronous serial communication	
Communication speed	2.5Mbps	

# PART NUMBERS

MX		201		N		2		S			N	
Code	Series	Code	Rated Output	Code	Holding Brake	Code	Voltage Specification	Code	Shaft End	Oil Seal	Code	Encoder Type
MX	Low Inertia	500	50W	N	Without	2	AC200V to 240V	S (P)	Straight	Without	N	17bit (incremental)
		101	100W					K (H)	Key	Without		
MY	Middle Inertia	201	200W	A	With	2	AC200V to 240V	T (R)	Straight	With	A	17bit (absolute)
MM		401	400W					L (J)	Key	With		
		751	750W									
MZ	High Inertia	102	1kW									
MH		152	1.5kW									
		202	2kW									

# MODEL NUMBER AND RATINGS

		MY500x2xx	MY101x2xx	MX201x2xx	MZ201x2xx	MX401x2xx	MZ401x2xx	MX751x2xx	MZ751x2xx	MM102x2xx	MH102x2xx	MM152x2xx	MH152x2xx	MM202x2xx	
Item	Units														
Inertia level	-	Middle	Middle	Low	High	Low	High	Low	High	Middle	High	Middle	High	Middle	
Fitting flange size	mm	40 sq.			60 sq.			80 sq.			130 sq.				
Motor length (without brake or oil seal)		66.4	82.4	76.5	93.5	110.5	107.3	122.3	128	163	145.5	180.5	163		
Motor length (without brake, with oil seal)		72	88												
Motor length (with brake, without oil seal)		106.8	122.8	113	130	147	144.3	159.3	153	188	170.5	205.5	188		
Motor length (with brake and oil seal)		112.4	128.4												
Approximate mass (without brake)	kg	0.4	0.5	0.8	1	1.3	1.5	2.2	2.5	5.6	7.6	7	9	8.4	
Approximate mass (with brake)	kg	0.6	0.8	1.3	1.5	1.8	2	3	3.3	7	9	8.4	10.4	9.8	
Compatible drive model number	-	DA2YZ	DA2Z1	DA212		DA224		DA238		DA24A		DA26B		DA28C	
Voltage	V	AC200 to 240V													
Rated output power	W	50	100	200		400		750		1000		1500		2000	
Rated torque	Nm	0.16	0.32	0.64		1.27		2.39		4.77		7.16		9.55	
Instantaneous maximum torque	Nm	0.56	1.12	1.91		3.82		7.1		14.3		21.5		28.6	
Rated current (stall current)	A	0.68	0.97	1.7		2.7		4.2		5.6		9		11.9	
Instantaneous maximum current	A	2.4	3.3	5.2		8.5		12.2		16.8		27		35.7	
Rated revolving speed	rpm	3000						2000							
Maximum revolving speed	rpm	6000						3000							
Torque constant	Nm/A	0.25	0.35	0.41		0.49		0.63		0.88		0.81		0.85	
Induced Voltage Constant per Phase	mV/rpm	8.8	12.3	14.3		17.1		21.9		30.9		28.4		29.6	
Rated power rate (without brake)	kW/s	6.5	16.5	28.2	9.1	69.4	23	76.6	35.4	50	9.2	76.9	13.8	104.9	

		MY500x2xx	MY101x2xx	MX201x2xx	MZ201x2xx	MX401x2xx	MZ401x2xx	MX751x2xx	MZ751x2xx	MM102x2xx	MH102x2xx	MM152x2xx	MH152x2xx	MM202x2xx
Item	Units													
Rated power rate (with brake)	kWs	5.4	14.6	23.5	8.6	61.8	22.1	60.7	31.6	36.5	8.6	61.4	13.3	87.9
Mechanical time constant (without brake)	ms	1.92	1.17	0.72	2.23	0.47	1.42	0.4	0.86	0.76	4.17	0.6	3.32	0.58
Mechanical time constant (with brake)	ms	2.31	1.32	0.87	2.38	0.53	1.47	0.5	0.96	1.05	4.43	0.75	3.46	0.69
Electrical time constant	ms	0.74	0.89	2.53	2.92	4.6	10.1	12.2	12.2					
Rotor moment of inertia (without brake)	x10 <sup>-4</sup> kgm <sup>2</sup>	0.039	0.061	0.14	0.44	0.23	0.71	0.74	1.61	4.56	24.9	6.67	37.12	8.7
Rotor moment of inertia (with brake)	x10 <sup>-4</sup> kgm <sup>2</sup>	0.047	0.069	0.17	0.47	0.26	0.73	0.94	1.81	6.24	26.4	8.35	38.65	10.38
Permissible radial load	N	68	245	392	490									
Permissible axial load	N	58	98	147	196									

# MODEL NUMBER AND BRAKE RATINGS

		MY500A2xx	MY101A2xx	MX201A2xx	MZ201A2xx	MX401A2xx	MZ401A2xx	MX751A2xx	MZ751A2xx	MM102A2xx	MH102A2xx	MM152A2xx	MH152A2xx	MM202A2xx
Item	Units													
Usage	-	Holding												
Rated voltage	V	DC 24V ± 10%												
Rated current	A	0.25	0.3	0.4	1.0									
Static friction torque	Nm	≥0.16	≥0.32	≥1.27	≥2.39	≥9.55								
Engage time	ms	≤35	≤50	≤70	≤120									
Release time	ms	≤20	≤15	≤20	≤30									
Release voltage	V	≥DC 1V												

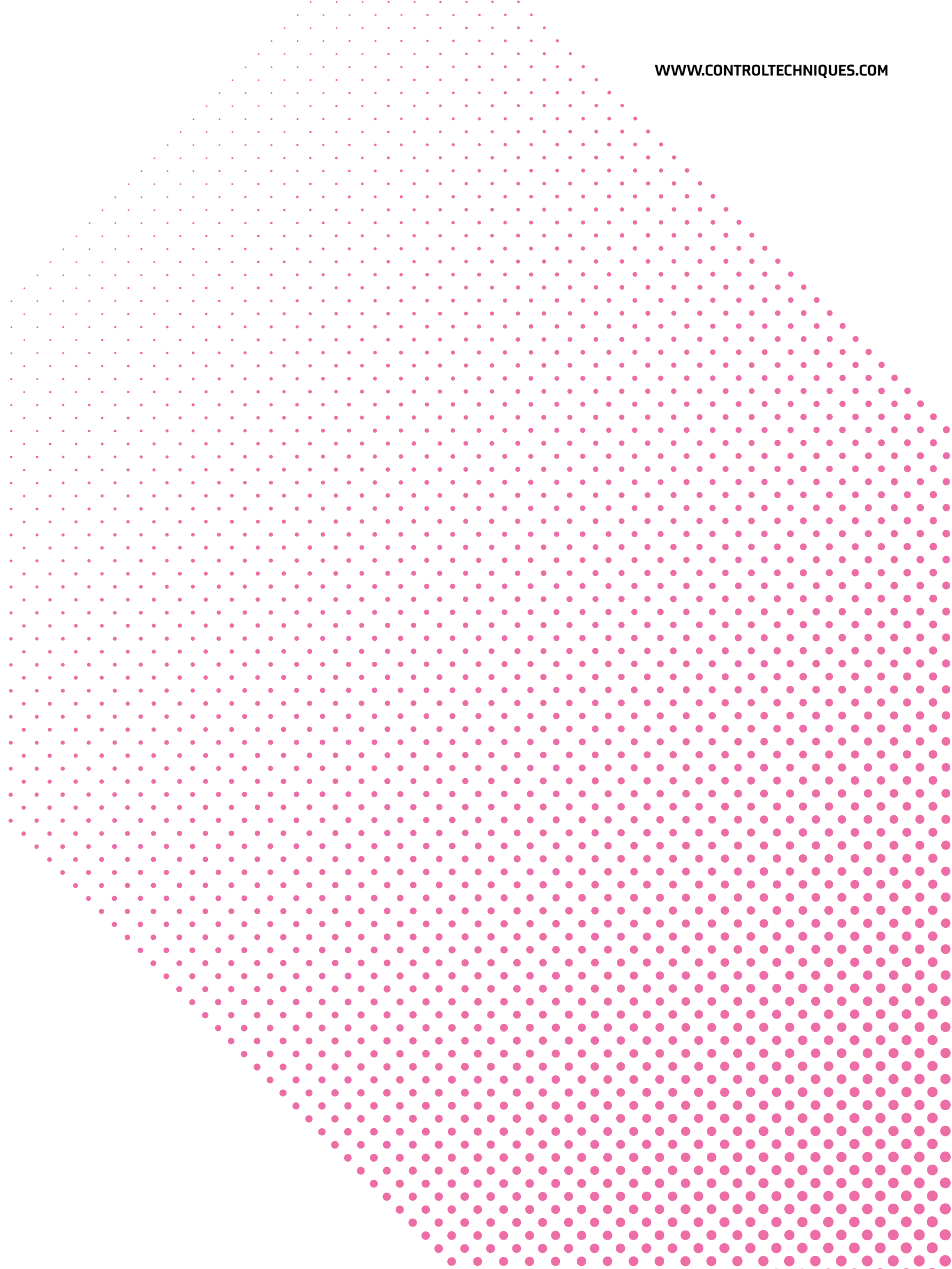

# UNIMOTOR HD

# HIGH DYNAMIC

# SERVO MOTOR

For pulse duty applications

**Unimotor hd is a high dynamic brushless AC servo motor range designed for use in pulse duty applications where rapid acceleration and deceleration are required.**

The motors are available in frame sizes from 060 to 190.

## Features

- Torque range: from 0.64 Nm to 85 Nm
- High torque to inertia ratio for high dynamic performance
- Compact but powerful
- High energy dissipation parking brakes
- IP65 conformance; sealed against water spray and dust when mounted and connected
- Segmented stator design
- World class performance
- Supported by rigorous testing for performance and reliability
- Winding voltage for inverter supply of 400 V and 220 V
- Rated speeds from 1,000 to 6,000 rpm
- Larger shafts to increase torsional rigidity
- Thermal protection by PTC thermistor/optional
- KTY84.130 sensor





# QUICK REFERENCE

Frame Size (mm)	PCD (mm)	Stall (Nm)	Interia (kg.cm <sup>2</sup> ) Standard	Interia (kg.cm <sup>2</sup> ) Medium	Interia (kg.cm <sup>2</sup> ) High
040	046	COMING IN 2021			
060	070	0.64 1.92	0.18 0.48	n/a	n/a
067	075	1.44 4.72	0.3 0.94	0.25 1.4	1.5 2.3
089	100	3.2 10.3	0.87 3.2	1.29 5.16	6.6 8.8
115	130	5.8 18.8	2.4 8.38	2.29 9.17	20.0 25.7
142	165	10.1 38.0	5.6 27.2	10.13 50.64	58.0 81.0
190	215	51.0 85.0	22.0 103.5	33.64 201.0	200.0 293.0



# ORDERING INFORMATION

Use the information below in the illustration to create an order code for a Unimotor hd.

060	UD	B	60	0	T
Frame size	Motor voltage	Stator length	Rated speed*	Brake	Connection type**
	060 - 190 frame	060 frame	060 frame	060 - 190 frame	060 frame
060	ED = 220V	A to C	60 = 6000 rpm	0 = Not fitted (Std)	F = Flying leads (0.5m Standard)
067	UD = 400V	067 - 115 frame	067 frame	060 frame	
089		A to D	30 = 3000 rpm	5 = Parking brake	S = Single cable, power & signal combined
115		142 frame	60 = 6000 rpm	067 - 142B frame	
142		A to E	089 frame	6 = Parking brake	T = YTEC type connector
190		190 frame	30 = 3000 rpm	142C - 190 frame	
		A to F	40 = 6000 rpm	5 = Parking brake	Size 1
			60 = 6000 rpm		B = Power and signal 90° rotatable
			115 - 142 frame		
			20 = 2000 rpm		D = Single cable, power & signal combined, 90° rotatable
			30 = 3000 rpm		
			40 = 4000 rpm		R = Power 8-way, Signal 90° rotatable
			60 = 6000 rpm		
			190 frame		Size 1.5
			10 = 1000 rpm		J = Power and signal 90° rotatable
			15 = 1500 rpm		
			20 = 2000 rpm		E = Single cable, power & signal combined, 90° rotatable
			30 = 3000 rpm		Z = Power 8-way, Signal 90° rotatable

\* Not all speeds are available on all motors. Please refer to performance pages 154 - 164.

\*\* Single cable only must be fitted with KTY thermistor and is only available with feedback options EG/FG, EM/FM, EF/FF, GB/HB. For recommended connector sizes please refer to performance pages 154-164.

Additional options are available upon request but may require a longer lead time to complete, please check with the Drive Centre.

A	CT	A
Output shaft	Feedback device	Thermistor
<b>060 – 190 frame</b>	<b>060 frame</b>	<b>060 – 190 frame</b>
A = Key	AR = Resolver	A = PTC Thermistor
B = Plain shaft	CT = Incremental Encoder	C = KTY Thermistor
	EG = Inductive EnDat Multi-turn	
	FG = Inductive EnDat Single-turn	
	<b>067 frame</b>	
	AR = Resolver	
	CR = Incremental Encoder	
	CT = Incremental Encoder	
	EM = Inductive EnDat SinCos Multi-turn	
	FM = Inductive EnDat SinCos Single-turn	
	EG = Inductive EnDat Multi-turn	
	FG = Inductive EnDat Single-turn	
	<b>089 – 190 frame</b>	
	AE = Resolver	
	CA = Incremental Encoder	
	CT = Incremental Encoder	
	EC = Inductive EnDat SinCos Multi-turn	
	FC = Inductive EnDat SinCos Single-turn	
	EF = Inductive EnDat Multi-turn FS	
	FF = Inductive EnDat Single-turn FS	
	GB = ROHS EnDat Multi-turn Size 58	
	HB = ROHS EnDat Single-turn Size 58	

# DIMENSIONS

## Frame size 060

Motor frame size (mm)	060ED		
Voltage (Vrms)	200-240		
Frame length	A	B	C
Continuous stall torque (Nm)	0.64	1.28	1.92
Peak torque (Nm)	2.24	4.48	6.72
Standard inertia (kg cm <sup>2</sup> )	0.18	0.33	0.48
Standard motor weight (kg)	1.6	2.0	2.2
Number of poles	10	10	10
Speed 6000 (rpm)	Kt (Nm/A) = Ke (V/krpm) =	0.4 26.5	
Rated torque (Nm)	0.64	1.28	1.92
Stall current (A)	1.81	3.06	4.31
Rated power (W)	400	800	1200
R (ph-ph) (Ohms)	5.15	1.9	1.15
L (ph-ph) (mH)	23.8	11.1	7.3
Recommended power conn' size	Y-TEC		

Motor frame size (mm)	060UD		
Voltage (Vrms)	380-480		
Frame length	A	B	C
Continuous stall torque (Nm)	0.64	1.28	1.92
Peak torque (Nm)	2.24	4.48	6.72
Standard inertia (kg cm <sup>2</sup> )	0.18	0.33	0.48
Standard motor weight (kg)	1.6	2.0	2.2
Number of poles	10	10	10
Speed 6000 (rpm)	Kt (Nm/A) = Ke (V/krpm) =	0.8 50	
Rated torque (Nm)	0.64	1.28	1.92
Stall current (A)	1.04	1.77	2.49
Rated power (W)	400	800	1200
R (ph-ph) (Ohms)	15.75	5.76	3.42
L (ph-ph) (mH)	71	33.2	22
Recommended power conn' size	Y-TEC		

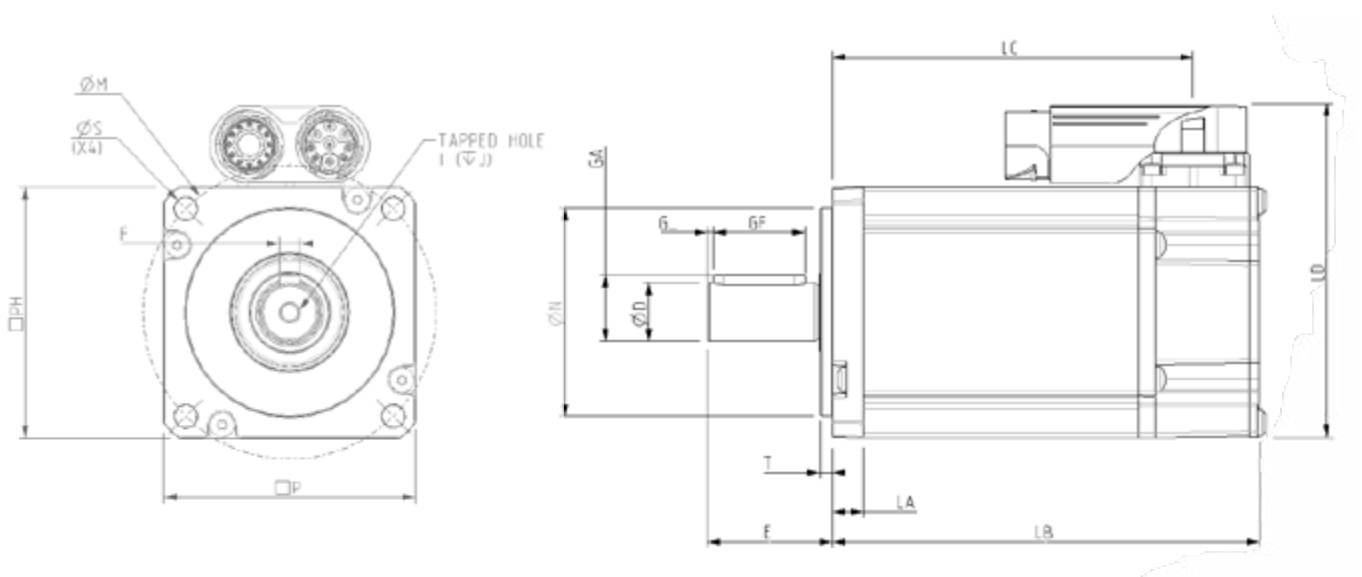

## Motor Dimensions

	Feedback AR, CT				Flange thickness	Register length	Register diameter	Overall height	Flange square	Fixing hole diameter	Fixing hole PCD	Motor housing	Mounting bolts
	Unbraked length		Braked length										
	LB (± 0.9)	LC (± 1.0)	LB (± 0.9)	LC (± 1.0)									
060A	82.5	66.5	119.5	103.5									
060B	102.5	86.5	139.5	123.5	7.5	3	50	80	60	5.5	70	60	M5 mm
060C	122.5	106.5	159.5	143.5									

	Feedback EG, FG	
	Unbraked length	Braked length
	LB (± 0.9)	LB (± 0.9)
060A	100	137
060B	120	157
060C	140	177

- All data subject to +/-10% tolerance.
- Stall torque, rated torque and power relate to maximum continuous operation tested in a 20°C ambient at 12 kHz drive switching frequency.
- All other figures relate to a 20°C motor temperature.
- Maximum intermittent winding temperature is 140°C.

## Shaft Dimensions

	Shaft diameter	Shaft length	Key height	Key length	Key to shaft end	Key width	Tapped hole thread size	Tapped hole depth
	D (j6)	E	GA	GF	G	F (h9)	I	J (± 1)
14.0 Std	14	30	16	22	1.5	5	M5 x 0.8	10 mm

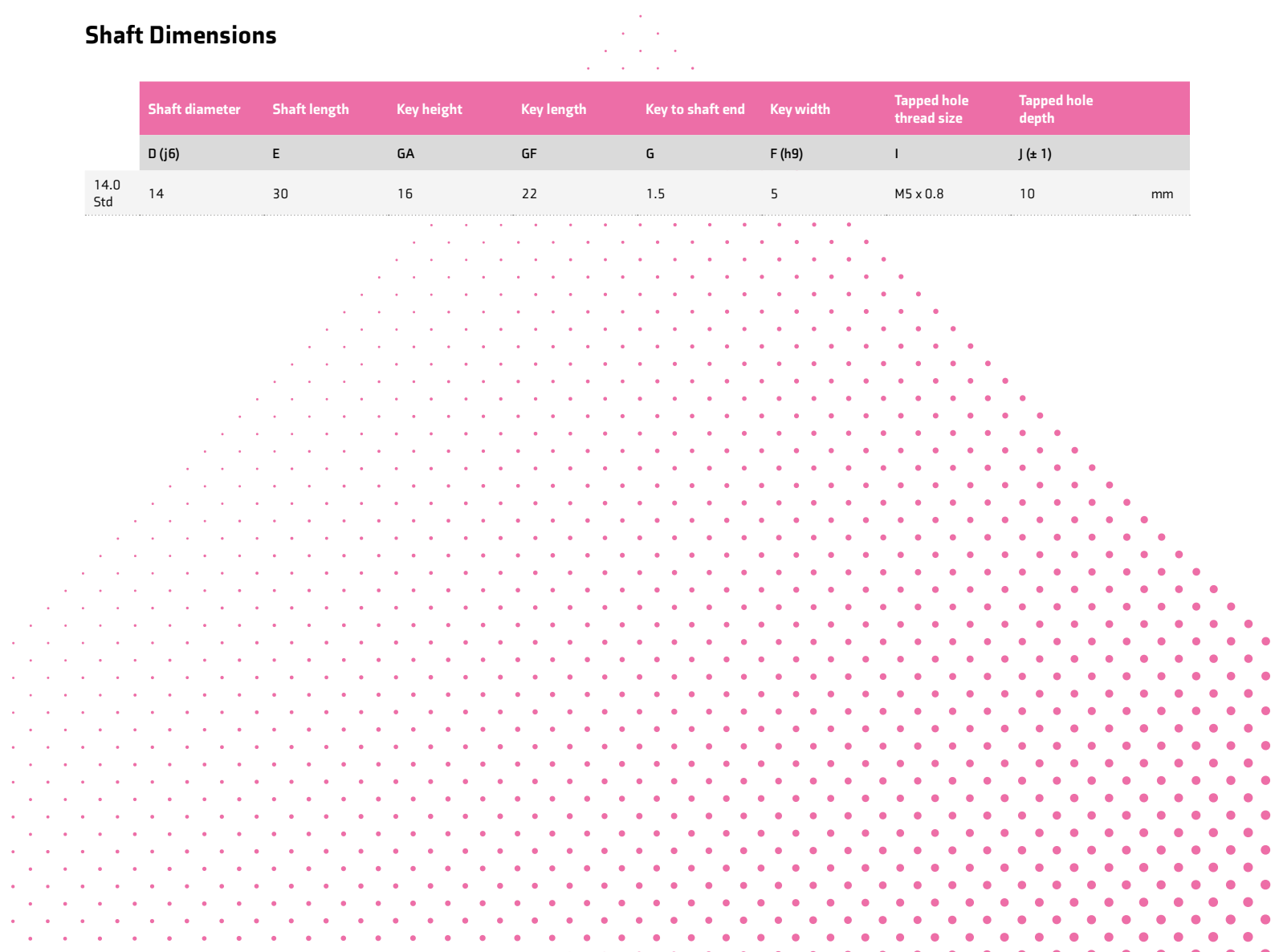

## Frame size 067

Motor frame size (mm)		067ED			
Voltage (Vrms)		200-240			
Frame length		A	B	C	D
Continuous stall torque (Nm)		1.44	2.55	3.7	4.72
Peak torque (Nm)		4.35	7.65	11.1	14.6
Standard inertia (kg cm <sup>2</sup> )		0.3	0.53	0.75	0.94
Winding thermal time constant (sec)		54	61	65	68
Standard motor weight (kg)		1.96	2.56	3.16	3.8
Number of poles		10	10	10	10
Speed 3000 (rpm)	Kt (Nm/A) = Ke (V/krpm) =	0.93 57			
Rated torque (Nm)		1.4	2.45	3.5	4.6
Stall current (A)		1.56	2.76	4	5.11
Rated power (kW)		0.44	0.77	1.1	2.5
R (ph-ph) (Ohms)		15.16	5.85	3.33	2.32
L (ph-ph) (mH)		46.7	20.6	12.7	10.6
Recommended power conn' size		1	1	1	1
Speed 6000 (rpm)	Kt (Nm/A) = Ke (V/krpm) =	0.47 28.5			
Rated torque (Nm)		1.3	2.2	3.1	4
Stall current (A)		3.12	5.52	8.01	10.22
Rated power (kW)		0.82	1.38	1.95	2.66
R (ph-ph) (Ohms)		3.79	1.46	0.76	0.43
L (ph-ph) (mH)		11.7	5.2	3.6	4.7
Recommended power conn' size		1	1	1	1

Motor frame size (mm)		067UD			
Voltage (Vrms)		380-480			
Frame length		A	B	C	D
Continuous stall torque (Nm)		1.44	2.55	3.7	4.72
Peak torque (Nm)		4.35	7.65	11.1	14.6
Standard inertia (kg cm <sup>2</sup> )		0.3	0.53	0.75	0.94
Winding thermal time constant (sec)		54	61	65	68
Standard motor weight (kg)		1.96	2.56	3.16	3.8
Number of poles		10	10	10	10
Speed 3000 (rpm)	Kt (Nm/A) = Ke (V/krpm) =	0.8 49	1.6 98		
Rated torque (Nm)		1.4	2.45	3.5	4.6
Stall current (A)		1.81	1.59	2.3	2.93
Rated power (kW)		0.44	0.77	1.1	2.5
R (ph-ph) (Ohms)		11.69	18.55	10.7	6.42
L (ph-ph) (mH)		35.2	65.6	40.8	31.2
Recommended power conn' size		1	1	1	1
Speed 6000 (rpm)	Kt (Nm/A) = Ke (V/krpm) =	0.8 49			
Rated torque (Nm)		1.3	2.2	3.1	4
Stall current (A)		1.79	3.17	4.6	5.87
Rated power (kW)		0.82	1.38	1.95	2.66
R (ph-ph) (Ohms)		11.69	4.64	2.73	1.6
L (ph-ph) (mH)		35.2	16.4	10.2	7.8
Recommended power conn' size		1	1	1	1

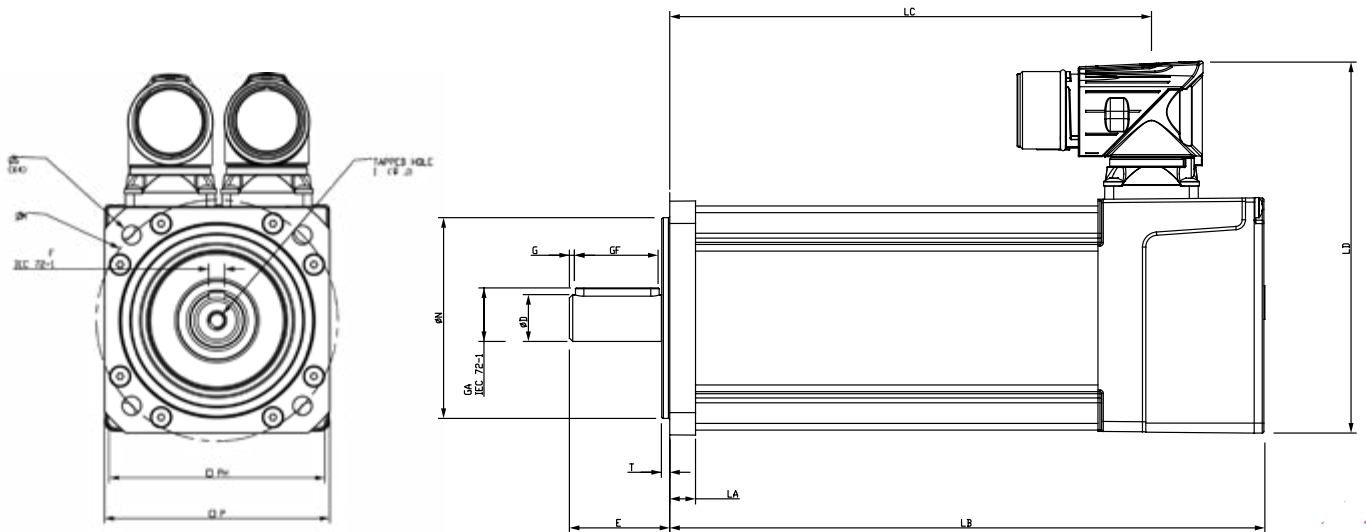

## Motor Dimensions

	Feedback AR, CR, EM, FM, EG, FG				Flange thickness	Register length	Register diameter	Overall height	Flange square	Fixing hole diameter	Fixing hole PCD	Motor housing	Mounting bolts	
	Unbraked length		Braked length											
	LB (± 0.9)	LC (± 1.0)	LB (± 0.9)	LC (± 1.0)										
067A	142.9	109	177.9	144	7.7	2.5	60	111.5	70	5.8	75	67	M5	mm
067B	172.9	138	207.9	174										
067C	202.9	169	237.9	204										
067D	232.9	199	267.9	234										

## Shaft Dimensions

	Shaft diameter	Shaft length	Key height	Key length	Key to shaft end	Key width	Tapped hole thread size	Tapped hole depth	
	D (j6)	E	GA	GF	G	F (h9)	I	J (± 1)	
14.0 Std	14	30	16	25	1.5	5	M5 x 0.8	13.5	mm

19mm shaft and 90mm flange options are available. Refer to factory for more information.

- All data subject to +/-10% tolerance.
- Stall torque, rated torque and power relate to maximum continuous operation tested in a 20°C ambient at 12 kHz drive switching frequency.
- All other figures relate to a 20°C motor temperature.
- Maximum intermittent winding temperature is 140°C.

## Frame size 089

Motor frame size (mm)		089ED			
Voltage (Vrms)		200-240			
Frame length		A	B	C	D
Continuous stall torque (Nm)		3.2	5.5	8	10.3
Peak torque (Nm)		9.6	16.5	24	31.5
Standard inertia (kgcm <sup>2</sup> )		0.87	1.61	2.34	3.2
Winding thermal time constant (sec)		85	93	98	103
Standard motor weight (kg)		3.18	4.28	5.38	6.48
Number of poles		10	10	10	10
Speed 3000 (rpm)	Kt (Nm/A) = Ke (V/krpm) =	0.93 57			
Rated torque (Nm)		3	4.85	6.9	8.5
Stall current (A)		3.46	5.95	8.66	11.15
Rated power (kW)		0.94	1.52	2.17	2.67
R (ph-ph) (Ohms)		3.9	1.57	0.89	0.45
L (ph-ph) (mH)		25	11.8	7.1	13.7
Recommended power conn' size		1	1	1	1
Speed 4000 (rpm)	Kt (Nm/A) = Ke (V/krpm) =	0.7 42.75			
Rated torque (Nm)		•	4.55	6.35	•
Stall current (A)		•	7.94	11.54	•
Rated power (kW)		•	1.91	2.66	•
R (ph-ph) (Ohms)		•	0.78	0.54	•
L (ph-ph) (mH)		•	6	4.3	•
Recommended power conn' size		•	1	1	•
Speed 6000 (rpm)	Kt (Nm/A) = Ke (V/krpm) =	0.47 28.5			
Rated torque (Nm)		2.65	3.8	5	•
Stall current (A)		6.93	11.9	17.32	•
Rated power (kW)		1.67	2.39	3.14	•
R (ph-ph) (Ohms)		0.98	0.39	0.24	•
L (ph-ph) (mH)		6.2	3	1.8	•
Recommended power conn' size		1	1	1	•

• Not available

Motor frame size (mm)		089UD			
Voltage (Vrms)		380-480			
Frame length		A	B	C	D
Continuous stall torque (Nm)		3.2	5.5	8	10.3
Peak torque (Nm)		9.6	16.5	24	31.5
Standard inertia (kgcm <sup>2</sup> )		0.87	1.61	2.34	3.2
Winding thermal time constant (sec)		85	93	98	103
Standard motor weight (kg)		3.18	4.28	5.38	6.48
Number of poles		10	10	10	10
Speed 3000 (rpm)	Kt (Nm/A) = Ke (V/krpm) =	1.6 98			
Rated torque (Nm)		3	4.85	6.9	8.5
Stall current (A)		1.99	3.42	4.97	6.4
Rated power (kW)		0.94	1.52	2.17	2.67
R (ph-ph) (Ohms)		10.25	4.93	2.77	1.98
L (ph-ph) (mH)		66.8	36.7	21.7	17.5
Recommended power conn' size		1	1	1	1
Speed 4000 (rpm)	Kt (Nm/A) = Ke (V/krpm) =	1.2 73.5			
Rated torque (Nm)		•	4.55	6.35	•
Stall current (A)		•	4.56	6.63	•
Rated power (kW)		•	1.91	2.66	•
R (ph-ph) (Ohms)		•	2.47	1.69	•
L (ph-ph) (mH)		•	18.8	13.4	•
Recommended power conn' size		•	1	1	•
Speed 6000 (rpm)	Kt (Nm/A) = Ke (V/krpm) =	0.8 49			
Rated torque (Nm)		2.65	3.8	5	•
Stall current (A)		3.98	6.84	9.95	•
Rated power (kW)		1.67	2.39	3.14	•
R (ph-ph) (Ohms)		2.56	1.23	0.67	•
L (ph-ph) (mH)		16.7	9.2	5.4	•
Recommended power conn' size		1	1	1	•

## Shaft Dimensions

	Shaft diameter	Shaft length	Key height	Key length	Key to shaft end	Key width	Tapped hole thread size	Tapped hole depth	
	D (j6)	E	GA	GF	G	F (h9)	I	J (± 1)	
19.0 Std	19	40	21.5	32	3.7	6	M6x1	17	mm

24mm shaft and 115mm flange options are available. Refer to factory for more information.



**Motor Dimensions**

	Feedback EC, FC, EF, FF				Flange thickness	Register length	Register diameter	Overall height	Flange square	Fixing hole diameter	Fixing hole PCD	Motor housing	Mounting bolts	
	Unbraked length		Braked length											
	LB (± 0.9)	LC (± 1.0)	LB (± 0.9)	LC (± 1.0)										
089A	147.8	110.5	187.9	150.6	10.3	2.2	80	130.5	91	7	100	89	M6	mm
089B	177.8	140.5	217.9	180.6										
089C	207.8	170.5	247.9	210.6										
089D	237.8	200.5	277.9	240.6										

	Feedback CA, GB, HB		Feedback AE		
	Unbraked length	Braked length	Unbraked length	Braked length	
	LB (± 0.9)	LB (± 0.9)	LB (± 0.9)	LB (± 0.9)	
089A	160.8	200.9	137.8	177.9	mm
089B	190.8	230.9	167.8	207.9	
089C	220.8	260.9	197.8	237.9	
089D	250.8	290.9	227.8	267.9	

- All data subject to +/-10% tolerance.
- Stall torque, rated torque and power relate to maximum continuous operation tested in a 20°C ambient at 12 kHz drive switching frequency.
- All other figures relate to a 20°C motor temperature.
- Maximum intermittent winding temperature is 140°C.

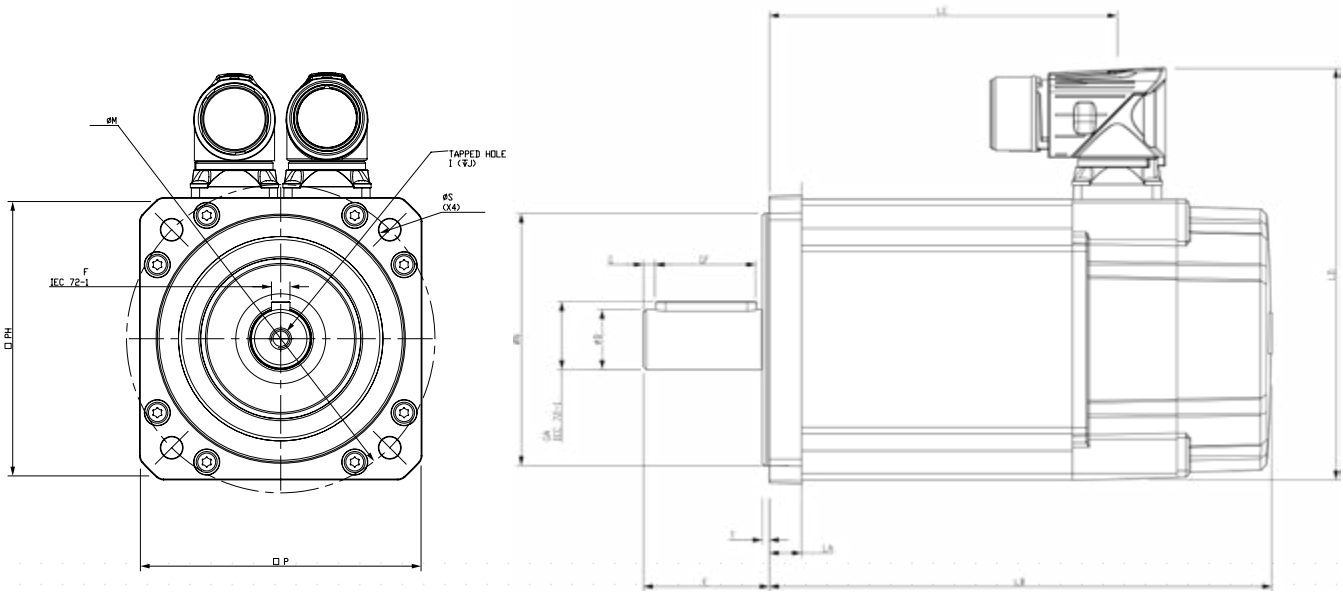

# Frame size 115

Motor frame size (mm)		115ED			
Voltage (Vrms)		200-240			
Frame length		A	B	C	D
Continuous stall torque (Nm)		5.8	10.2	14.6	18.8
Peak torque (Nm)		17.4	30.6	43.8	56.4
Standard inertia (kgcm <sup>2</sup> )		2.40	4.41	6.39	8.38
Winding thermal time constant (sec)		161	164	168	175
Standard motor weight (kg)		5.20	6.95	8.72	10.49
Number of poles		10	10	10	10
Speed 2000 (rpm)	Kt (Nm/A) = Ke (V/krpm) =	1.4 85.5			
Rated torque (Nm)		•	•	11.9	15.6
Stall current (A)		•	•	10.53	13.56
Rated power (kW)		•	•	2.49	3.27
R (ph-ph) (Ohms)		•	•	0.77	0.61
L (ph-ph) (mH)		•	•	7.9	6.6
Recommended power conn' size		•	•	1	1
Speed 3000 (rpm)	Kt (Nm/A) = Ke (V/krpm) =	0.93 57			
Rated torque (Nm)		4.8	7.7	10.5	•
Stall current (A)		6.28	11.04	15.8	•
Rated power (kW)		1.51	2.42	3.30	•
R (ph-ph) (Ohms)		1.59	0.58	0.39	•
L (ph-ph) (mH)		12.8	5.4	4	•
Recommended power conn' size		1	1	1	•
Speed 4000 (rpm)	Kt (Nm/A) = Ke (V/krpm) =	0.7 42.75			
Rated torque (Nm)		•	•	8.7	•
Stall current (A)		•	•	21.07	•
Rated power (kW)		•	•	3.64	•
R (ph-ph) (Ohms)		•	•	0.12	•
L (ph-ph) (mH)		•	•	4	•
Recommended power conn' size		•	•	1	•
Speed 6000 (rpm)	Kt (Nm/A) = Ke (V/krpm) =	0.47 28.5			
Rated torque (Nm)		3.6	4.8	•	•
Stall current (A)		12.55	22.08	•	•
Rated power (kW)		2.27	3.02	•	•
R (ph-ph) (Ohms)		0.4	0.09	•	•
L (ph-ph) (mH)		3.2	2.8	•	•
Recommended power conn' size		1	1	•	•

Motor frame size (mm)		115UD			
Voltage (Vrms)		380-480			
Frame length		A	B	C	D
Continuous stall torque (Nm)		5.8	10.2	14.6	18.8
Peak torque (Nm)		17.4	30.6	43.8	56.4
Standard inertia (kgcm <sup>2</sup> )		2.40	4.41	6.39	8.38
Winding thermal time constant (sec)		161	164	168	175
Standard motor weight (kg)		5.20	6.95	8.72	10.49
Number of poles		10	10	10	10
Speed 2000 (rpm)	Kt (Nm/A) = Ke (V/krpm) =	2.4 147			
Rated torque (Nm)		•	•	11.9	15.6
Stall current (A)		•	•	6.05	7.79
Rated power (kW)		•	•	2.49	3.27
R (ph-ph) (Ohms)		•	•	2.41	1.8
L (ph-ph) (mH)		•	•	24.7	19.5
Recommended power conn' size		•	•	1	1
Speed 3000 (rpm)	Kt (Nm/A) = Ke (V/krpm) =	1.6 98			
Rated torque (Nm)		4.8	7.7	10.5	13.6
Stall current (A)		3.61	6.34	9.08	11.69
Rated power (kW)		1.51	2.42	3.3	4.27
R (ph-ph) (Ohms)		5	1.9	1.21	0.78
L (ph-ph) (mH)		40.3	18	12.7	8.7
Recommended power conn' size		1	1	1	1
Speed 4000 (rpm)	Kt (Nm/A) = Ke (V/krpm) =	1.2 74			
Rated torque (Nm)		•	•	8.7	•
Stall current (A)		•	•	12.1	•
Rated power (kW)		•	•	3.64	•
R (ph-ph) (Ohms)		•	•	0.6	•
L (ph-ph) (mH)		•	•	6.6	•
Recommended power conn' size		•	•	1	•
Speed 6000 (rpm)	Kt (Nm/A) = Ke (V/krpm) =	0.8 49			
Rated torque (Nm)		3.6	4.8	•	•
Stall current (A)		7.21	12.68	•	•
Rated power (kW)		2.27	3.02	•	•
R (ph-ph) (Ohms)		1.25	0.47	•	•
L (ph-ph) (mH)		10.1	4.5	•	•
Recommended power conn' size		1	1	•	•

• Not available

**Motor Dimensions**

	Feedback EC, FC, EF, FF				Flange thickness	Register length	Register diameter	Overall height	Flange square	Fixing hole diameter	Fixing hole PCD	Motor housing	Mounting bolts	
	Unbraked length		Braked length											
	LB (± 0.9)	LC (± 1.0)	LB (± 0.9)	LC (± 1.0)										
115A	163.8	124	200.9	161.1	13.2	2.7	110	156.5	116	10	130	115	M8	mm
115B	193.8	154	230.9	191.1										
115C	223.8	184	260.9	221.1										
115D	253.8	214	290.9	251.1										

	Feedback CA, GB, HB		Feedback AE		
	Unbraked length	Braked length	Unbraked length	Braked length	
	LB (± 0.9)	LB (± 0.9)	LB (± 0.9)	LB (± 0.9)	
115A	176.8	213.9	153.8	190.9	mm
115B	206.8	243.9	183.8	220.9	
115C	236.8	273.9	213.8	250.9	
115D	266.8	303.9	243.8	280.9	

- All data subject to +/-10% tolerance.
- Stall torque, rated torque and power relate to maximum continuous operation tested in a 20°C ambient at 12kHz drive switching frequency.
- All other figures relate to a 20°C motor temperature.
- Maximum intermittent winding temperature is 140°C.

**Shaft Dimensions**

	Shaft diameter	Shaft length	Key height	Key length	Key to shaft end	Key width	Tapped hole thread size	Tapped hole depth	
	D (j6)	E	GA	GF	G	F (h9)	I	J (± 1)	
24.0 Std	24	50	27	40	5.3	8	M8 x 1.25	20	mm

28mm shaft and 145mm flange options are available. Refer to factory for more information.

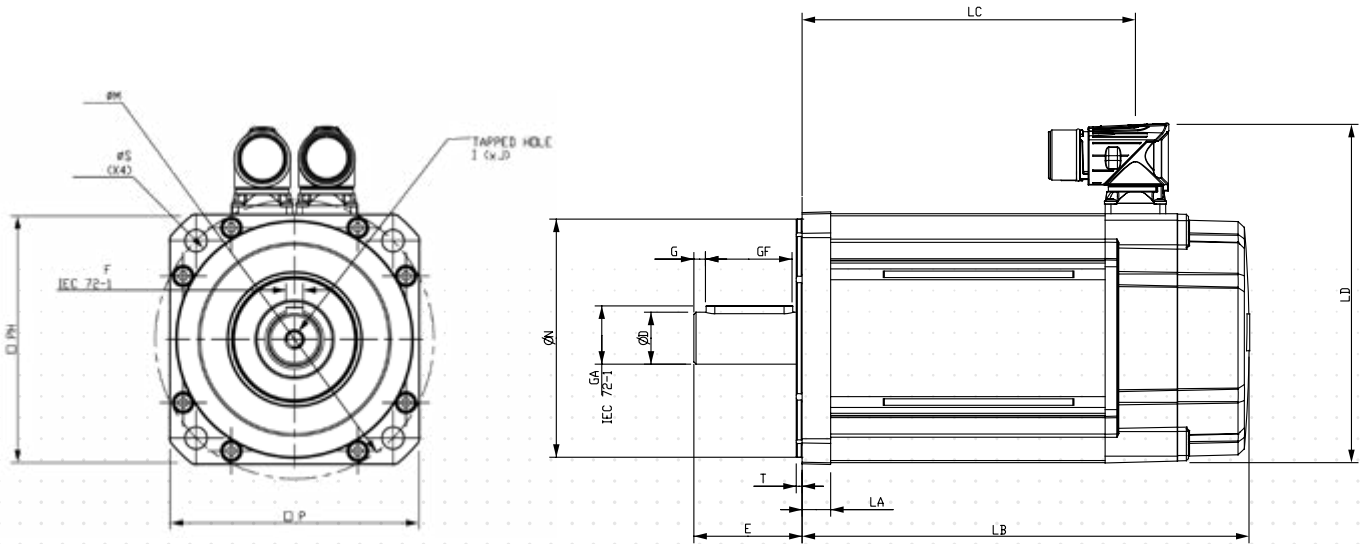

# Frame size 142

Motor frame size (mm)		142ED				
Voltage (Vrms)		200-240				
Frame length		A	B	C	D	E
Continuous stall torque (Nm)		10.1	17.4	25	31.5	38
Peak torque (Nm)		30.3	55.3	74.9	94.5	114
Standard inertia (kgcm <sup>2</sup> )		5.6	11	17	22.1	27.2
Winding thermal time constant (sec)		216	240	245	251	256
Standard motor weight (kg)		7.4	10.1	12.74	15.39	18.04
Number of poles		10	10	10	10	10
Speed 2000 (rpm)	Kt (Nm/A) = Ke (V/krpm) =	1.4 85.5				
Rated torque (Nm)		8.6	15.3	21.4	•	•
Stall current (A)		7.29	12.55	18.04	•	•
Rated power (kW)		1.8	3.2	4.48	•	•
R (ph-ph) (Ohms)		0.85	0.32	0.19	•	•
L (ph-ph) (mH)		14.3	5.9	3.7	•	•
Recommended power conn' size		1	1	1	•	•
Speed 3000 (rpm)	Kt (Nm/A) = Ke (V/krpm) =	0.93 57				
Rated torque (Nm)		8.2	14	18.4	20.9	•
Stall current (A)		10.93	18.83	27.06	34.09	•
Rated power (kW)		2.58	4.4	5.78	6.57	•
R (ph-ph) (Ohms)		0.38	0.22	0.12	0.09	•
L (ph-ph) (mH)		6.3	4.4	1.9	1.6	•
Recommended power conn' size		1	1	1	1.5	•
Speed 4000 (rpm)	Kt (Nm/A) = Ke (V/krpm) =	0.7 42.75				
Rated torque (Nm)		•	11.7	•	•	•
Stall current (A)		•	25.11	•	•	•
Rated power (kW)		•	4.89	•	•	•
R (ph-ph) (Ohms)		•	0.08	•	•	•
L (ph-ph) (mH)		•	4.5	•	•	•
Recommended power conn' size		•	1	•	•	•
Speed 6000 (rpm)	Kt (Nm/A) = Ke (V/krpm) =	0.47 28.5				
Rated torque (Nm)		•	•	•	•	•
Stall current (A)		•	•	•	•	•
Rated power (kW)		•	•	•	•	•
R (ph-ph) (Ohms)		•	•	•	•	•
L (ph-ph) (mH)		•	•	•	•	•
Recommended power conn' size		•	•	•	•	•

Motor frame size (mm)		142UD				
Voltage (Vrms)		380-480				
Frame length		A	B	C	D	E
Continuous stall torque (Nm)		10.1	17.4	25	31.5	38
Peak torque (Nm)		30.3	55.3	74.9	94.5	114
Standard inertia (kgcm <sup>2</sup> )		5.6	11	17	22.1	27.2
Winding thermal time constant (sec)		216	240	245	251	256
Standard motor weight (kg)		7.4	10.1	12.74	15.39	18.04
Number of poles		10	10	10	10	10
Speed 2000 (rpm)	Kt (Nm/A) = Ke (V/krpm) =	2.4 147				
Rated torque (Nm)		8.6	15.3	21.4	•	•
Stall current (A)		4.19	7.21	10.36	•	•
Rated power (kW)		1.8	3.2	4.48	•	•
R (ph-ph) (Ohms)		3.9	1.53	0.79	•	•
L (ph-ph) (mH)		46.3	21	12.2	•	•
Recommended power conn' size		1	1	1	•	•
Speed 3000 (rpm)	Kt (Nm/A) = Ke (V/krpm) =	1.6 98				
Rated torque (Nm)		8.2	14	18.4	20.9	23
Stall current (A)		6.28	10.82	15.54	19.58	23.62
Rated power (kW)		2.58	4.4	5.78	6.57	7.23
R (ph-ph) (Ohms)		1.16	0.63	0.34	0.24	0.18
L (ph-ph) (mH)		19.4	8.6	5.3	3.8	2.9
Recommended power conn' size		1	1	1	1.5	1.5
Speed 4000 (rpm)	Kt (Nm/A) = Ke (V/krpm) =	1.2 74				
Rated torque (Nm)		•	11.7	•	14.9	•
Stall current (A)		•	14.42	•	26.11	•
Rated power (kW)		•	4.89	•	6.26	•
R (ph-ph) (Ohms)		•	0.36	•	0.16	•
L (ph-ph) (mH)		•	7.1	•	2.4	•
Recommended power conn' size		•	1	•	1	•
Speed 6000 (rpm)	Kt (Nm/A) = Ke (V/krpm) =	0.8 49				
Rated torque (Nm)		•	7	•	•	•
Stall current (A)		•	21.63	•	•	•
Rated power (kW)		•	4.4	•	•	•
R (ph-ph) (Ohms)		•	0.17	•	•	•
L (ph-ph) (mH)		•	3.2	•	•	•
Recommended power conn' size		•	1	•	•	•

• Not available

### Motor Dimensions

	Feedback EC, FC, EF, FF				Flange thickness	Register length	Register diameter	Overall height	Flange square	Fixing hole diameter	Fixing hole PCD	Motor housing	Mounting bolts
	Unbraked length		Braked length										
	LB (± 0.9)	LC (± 1.0)	LB (± 0.9)	LC (± 1.0)									
142A	157	122.5	222.5	188									
142B	187	152.5	252.5	218			183.5						
142C	217	182.5	282.5	248	14	3.4	130		142	12	165	142	M10 mm
142D	247	212.5	312.5	278				183.5-					
142E	277	242.5	342.5	308				204.5					

### Shaft Dimensions

	Shaft diameter	Shaft length	Key height	Key length	Key to shaft end	Key width	Tapped hole thread size	Tapped hole depth
	D (j6)	E	GA	GF	G	F (h9)	I	J (± 1)
32.0 Std	32	58	35	50	3	10	M12 x 1.75	29 mm

24mm shaft and 200mm flange options are available. Refer to factory for more information.

- All data subject to +/- 10% tolerance.
- Stall torque, rated torque and power relate to maximum continuous operation tested in a 20°C ambient at 12kHz drive switching frequency.
- All other figures relate to a 20°C motor temperature.
- Maximum intermittent winding temperature is 140°C.

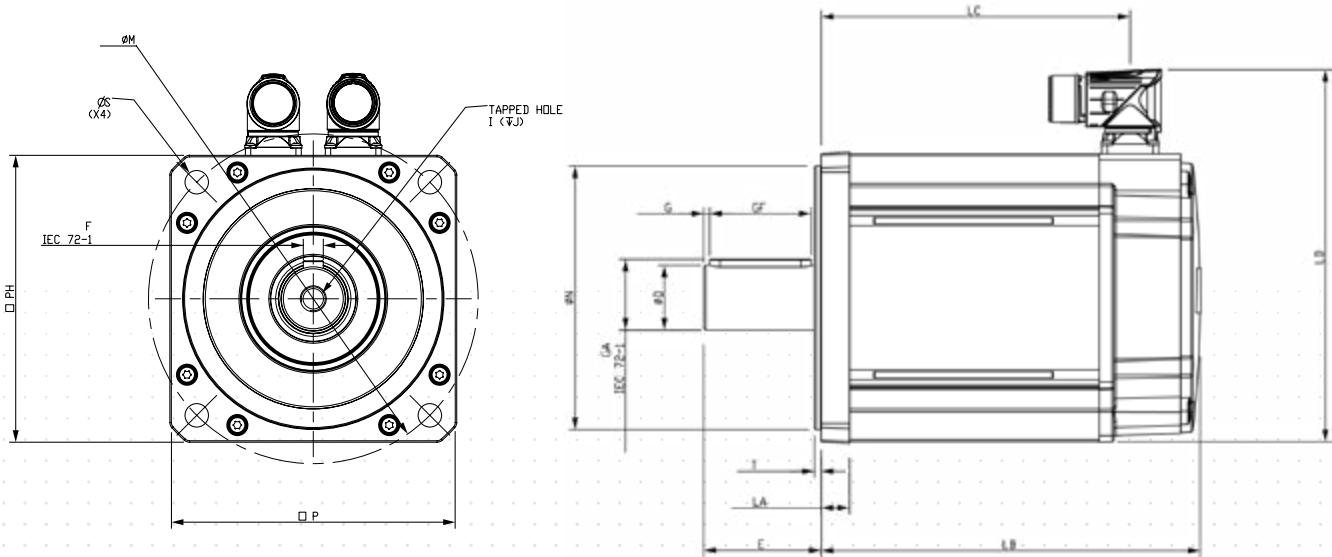

# Frame size 190

Motor frame size (mm)		190ED					
Voltage (Vrms)		200-240					
Frame length		A	B	C	D	E	F
Continuous stall torque (Nm)		18.5	32.7	52	62	73.5	85
Peak torque (Nm)		51	95	156	186	221	255
Standard inertia (kgcm <sup>2</sup> )		22.0	38.3	54.6	70.9	87.2	103.5
Winding thermal time constant (sec)		286	313	311	316	292	324
Standard motor weight (kg)		14.6	21.2	27.74	34.3	40.9	47.42
Number of poles		10	10	10	10	10	10
Speed 1000 (rpm)	Kt (Nm/A) = Ke (V/krpm) =	2.8 171					
Rated torque (Nm)		17.6	•	49.0	56.5	•	77.5
Stall current (A)		6.67	•	17.32	22.37	•	30.66
Rated power (kW)		1.83	•	5.13	5.92	•	8.12
R (ph-ph) (Ohms)		1.23	•	0.35	0.27	•	0.15
L (ph-ph) (mH)		34.1	•	10	7.1	•	4.8
Recommended power conn' size		1.5	•	1.5	1.5	•	1.5
Speed 1500 (rpm)	Kt (Nm/A) = Ke (V/krpm) =	1.86 114					
Rated torque (Nm)		•	•	46.2	•	•	•
Stall current (A)		•	•	25.97	•	•	•
Rated power (kW)		•	•	7.26	•	•	•
R (ph-ph) (Ohms)		•	•	0.11	•	•	•
L (ph-ph) (mH)		•	•	3.5	•	•	•
Recommended power conn' size		•	•	1.5	•	•	•
Speed 2000 (rpm)	Kt (Nm/A) = Ke (V/krpm) =	1.4 85.5					
Rated torque (Nm)		•	•	42.5	•	•	•
Stall current (A)		•	•	34.63	•	•	•
Rated power (kW)		•	•	8.9	•	•	•
R (ph-ph) (Ohms)		•	•	0.09	•	•	•
L (ph-ph) (mH)		•	•	2.5	•	•	•
Recommended power conn' size		•	•	1.5	•	•	•
Speed 3000 (rpm)	Kt (Nm/A) = Ke (V/krpm) =	0.93 57					
Rated torque (Nm)		15.5	25	32.8	•	•	•
Stall current (A)		20.02	35.39	51.95	•	•	•
Rated power (kW)		4.87	7.85	10.3	•	•	•
R (ph-ph) (Ohms)		0.13	0.05	0.03	•	•	•
L (ph-ph) (mH)		3.7	4.5	2.7	•	•	•
Recommended power conn' size		1.5	1.5	1.5	•	•	•

• Not available

Motor frame size (mm)		190UD					
Voltage (Vrms)		380-480					
Frame length		A	B	C	D	E	F
Continuous stall torque (Nm)		18.5	32.7	52	62	73.5	85
Peak torque (Nm)		51	95	156	186	221	255
Standard inertia (kgcm <sup>2</sup> )		22.0	38.3	54.6	70.9	87.2	103.5
Winding thermal time constant (sec)		286	313	311	316	292	324
Standard motor weight (kg)		14.6	21.2	27.74	34.3	40.9	47.42
Number of poles		10	10	10	10	10	10
Speed 1000 (rpm)	Kt (Nm/A) = Ke (V/krpm) =	4.8 296					
Rated torque (Nm)		17.6	•	•	•	•	78.3
Stall current (A)		3.83	•	•	•	•	17.61
Rated power (kW)		1.83	•	•	•	•	8.12
R (ph-ph) (Ohms)		3.7	•	•	•	•	0.53
L (ph-ph) (mH)		101.4	•	•	•	•	15.8
Recommended power conn' size		1.5	•	•	•	•	1.5
Speed 1500 (rpm)	Kt (Nm/A) = Ke (V/krpm) =	3.2 196					
Rated torque (Nm)		•	•	46.2	•	•	68.5
Stall current (A)		•	•	14.92	•	•	26.42
Rated power (kW)		•	•	7.26	•	•	10.76
R (ph-ph) (Ohms)		•	•	0.55	•	•	0.23
L (ph-ph) (mH)		•	•	14.2	•	•	6.8
Recommended power conn' size		•	•	1.5	•	•	1.5
Speed 2000 (rpm)	Kt (Nm/A) = Ke (V/krpm) =	2.4 147					
Rated torque (Nm)		•	•	42.5	45.3	52.9	56
Stall current (A)		•	•	19.89	25.69	30.46	35.22
Rated power (kW)		•	•	8.9	9.5	11.07	11.7
R (ph-ph) (Ohms)		•	•	0.32	0.17	0.16	0.14
L (ph-ph) (mH)		•	•	8.2	5.1	4.6	4.3
Recommended power conn' size		•	•	1.5	1.5	1.5	1.5
Speed 3000 (rpm)	Kt (Nm/A) = Ke (V/krpm) =	1.6 98					
Rated torque (Nm)		15.5	25	32.8	39	•	•
Stall current (A)		11.5	20.33	29.84	38.54	•	•
Rated power (kW)		4.87	7.85	10.3	13.82	•	•
R (ph-ph) (Ohms)		0.41	0.23	0.11	0.09	•	•
L (ph-ph) (mH)		11.4	5.7	3.1	3.1	•	•
Recommended power conn' size		1.5	1.5	1.5	1.5	•	•

**Motor Dimensions**

	Unbraked length		Braked length		Flange thickness	Register length	Register diameter	Overall height	Flange square	Fixing hole diameter	Fixing hole PCD	Motor housing	Mounting bolts	
	LB (± 0.9)	LC (± 1.0)	LB (± 0.9)	LC (± 1.0)										
190A	160.6	131.1	259.1	229.6	18.5	3.9	180	252.5	190.3	14.5	215	190	M12	mm
190B	190.6	161.1	289.1	259.6										
190C	220.6	191.1	319.1	289.6										
190D	250.6	221.1	349.1	319.6										
190E	280.6	251.1	379.1	349.6										
190F	310.6	281.1	409.1	379.6										

**Shaft Dimensions**

	Shaft diameter	Shaft length	Key height	Key length	Key to shaft end	Key width	Tapped hole thread size	Tapped hole depth	
	D (j6)	E	GA	GF	G	F (h9)	I	J (± 1)	
38.0 Std	38	80	41	70	4.6	10	M12 x 1.75	29	mm

42mm shaft and 235mm flange options are available. Refer to factory for more information.

- All data subject to +/-10% tolerance.
- All other figures relate to a 20°C motor temperature.
- Stall torque, rated torque and power relate to maximum continuous operation tested in a 20°C ambient at 12kHz drive switching frequency.
- Maximum intermittent winding temperature is 140°C.

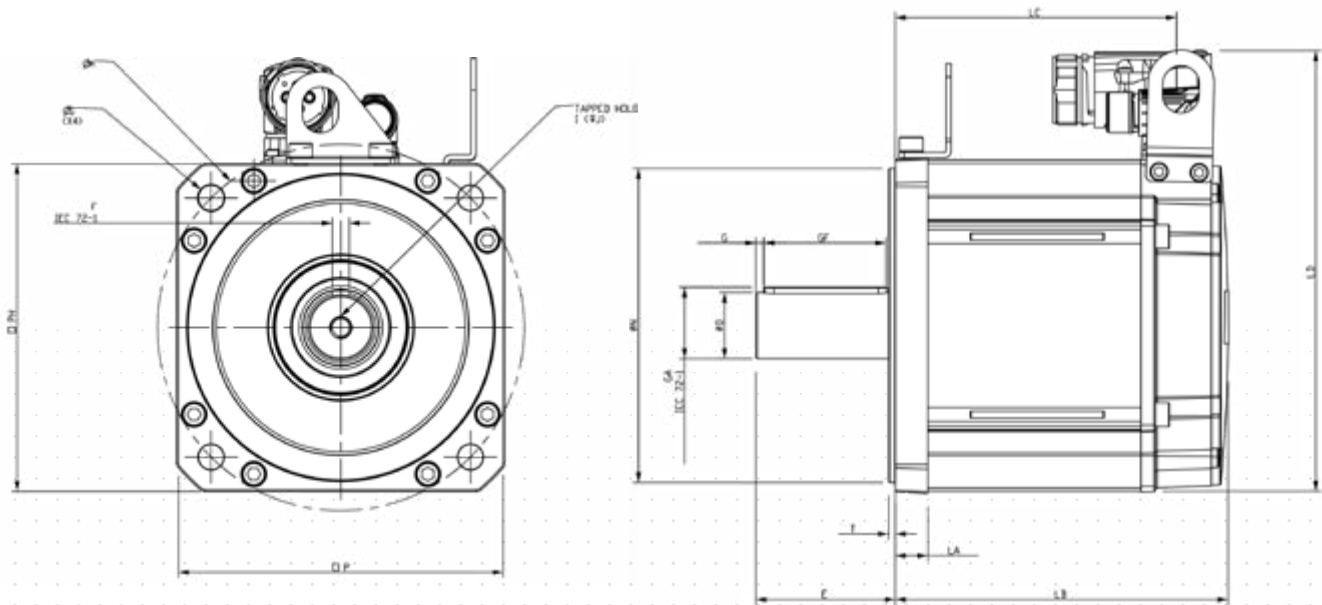

# PART NUMBERS

Frame Size	Motor Voltage	Stator Length	Rated Speed	Brake	Connection Type	Output Shaft	Feedback Device	Inertia + Thermistor Type
<b>089</b>	<b>UD</b>	<b>B</b>	<b>30</b>	<b>0</b>	<b>B</b>	<b>A</b>	<b>CA</b>	<b>A</b>

Frame Size	Rated Speed	Connection Type	Output Shaft	Feedback Device	Inertia + Thermistor Type
055 067 089 115 142 190	0 = Not fitted 5 = Parking Brake (fibre) 6 = Parking Brake (resin) x = Special	<b>Size 1</b> B = Power and signal 90° rotatable D = Single cable, power & Signal combined, 90° rotatable <b>Size 1.5</b> J = Power and signal 90° rotatable E = Single cable, power & signal combined, 90° rotatable	A = Key B = Plain E = Key with half key fitted F = Key and half key supplied separately*	A = Standard + PTC C = Standard inertia + KTY84-130 Thermistor E = Standard + PTC Thermistor + Lifting brackets (190 frame)	

Motor Voltage	Stator Length	Rated Speed
ED = 200V	<b>55 Frame</b> 30 = 3000 rpm 60 = 6000 rpm	
UD = 400V	<b>067 Frame</b> 30 = 3000 rpm 60 = 6000 rpm	
	<b>089 Frame</b> 30 = 3000 rpm 40 = 4000 rpm 60 = 6000 rpm	
055-067 ABC	<b>115 Frame</b> 20 = 2000 rpm 30 = 3000 rpm	
089 ABC	<b>142 Frame</b> 10 = 1000 rpm 15 = 1500 rpm 20 = 2000 rpm 30 = 3000 rpm	
115 BCD	<b>190 Frame</b> 10 = 1000 rpm 15 = 1500 rpm 20 = 2000 rpm	
142 CDE		
190 CDF		

055 to 067 Frame Sizes					
Code	Type	Incremental Resolution	Absolute Resolution	Accuracy	Single Cable
AR	Resolver	14 bit	-	±600"	no
EG	Absolute (Multi turn)	19 bit	12 bit	±120"	yes
FG	Absolute (Single turn)	19 bit	-	±120"	yes
TL	Absolute (Multi turn)	17 bit	12 bit	±120"	no
UL	Absolute (Single turn)	17 bit	-	±120"	no

089 to 190 Frame Sizes					
Code	Type	Incremental Resolution	Absolute Resolution	Accuracy	Single Cable
AE	Resolver	14 bit	-	±720"	no
EF	Absolute (Multi turn)	19 bit	12 bit	±65"	yes
FF	Absolute (Single turn)	19 bit	-	±65"	yes
RA	Absolute (Multi turn)	20 bit	12 bit	±52"	no
SA	Absolute (Single turn)	20 bit	-	±52"	no

Additional feedback options available on request.

<sup>1</sup> not available for 055 & 190 frames

<sup>2</sup> not available on 055 frame.

\*For stator length and connection type see pages 38 - 43



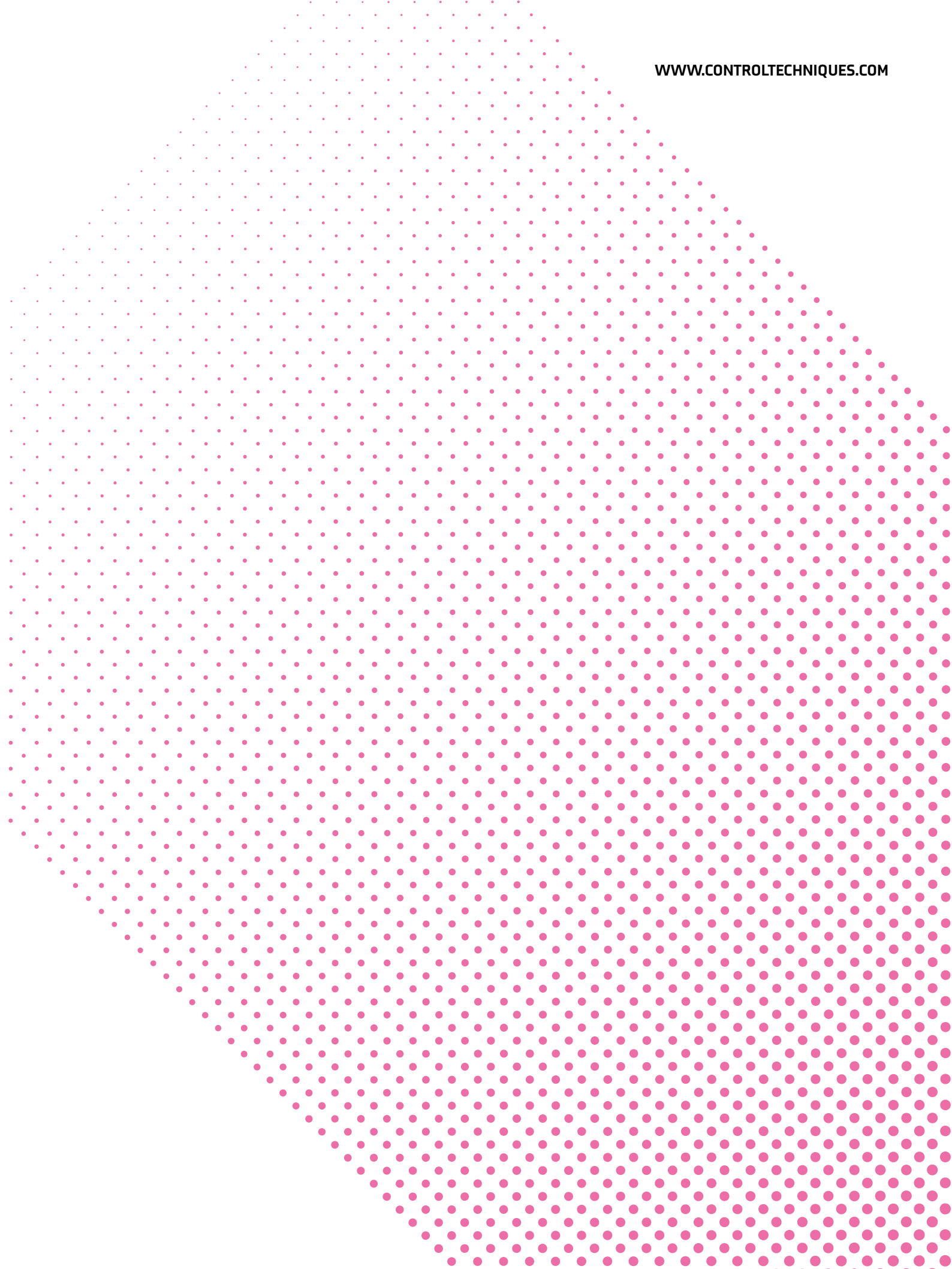

# DC DRIVES

## MENTOR MP

# MENTOR MP

# OPTIMUM PERFORMANCE, FLEXIBLE SYSTEM

25A to 7400A Two or four quadrant operation (regenerative)

24V - 480V | 500V - 575V | 500V - 690V

## The ultimate DC drive

**As a world leader in DC drive technology, our innovative products are used in the most demanding applications requiring performance, reliability & energy efficiency.**

Mentor MP integrates the control platform from the world's leading intelligent AC drive technology making it the most advanced DC drive available. With optimum performance and flexible system interfacing capability, the Mentor MP drive allows you to maximize motor performance & enhance system reliability. Interface digitally with modern control equipment using Ethernet & fieldbus networks. It is very easy to retrofit from Mentor II & for high power configuration.

### Benefits:

- Easy to set-up and commission
- Drive intelligence and system integration
- Machine communications flexibility



# KEY FUNCTIONS

Function		Function		Function	
Jog	✓	Autotune continuous	✓	Motorised potentiometer	✓
Bi-polar reference	✓	Catch a spinning motor	✓	Logic function control	✓
Pre-set speeds	8	Stop mode: Ramp	✓	Timer function control	✓
Preset timer	✓	Stop mode: Coast	✓	Limit switch control	✓
Skip speed	3	Stop mode: Fast ramp	✓	Variable selector	✓
Skip speed bands	✓	Regen braking (four quadrant drives)	✓	PID Control	✓
Local/Remote	✓	Programmable braking	✓	Energy meter	✓
S-Ramp	✓	Field economy control	✓	Trip time stamping	✓
Acceleration rates	8	Field weakening control mode	✓	Trip logging	8
Deceleration rates	8	DC contactor control	✓	Run time log	✓
Pulse train frequency reference	0 - 500kHz	Supply loss detection	✓	Parallel 6, 12 and 24 pulse operation	✓
Torque reference	✓	Low voltage operation	✓	Control word control	✓
Control mode: speed	✓	Analogue input control	✓	Auto reset	✓
Control mode: torque	✓	Analogue output control	✓	Cloning	✓
Control mode: torque control with speed override	✓	Temperature monitoring	✓	On-board PLC	6kB
Control mode: winder (torque control)	✓	Digital input control	✓	Additional application parameters	64
Armature voltage drop compensation	✓	Digital output control	✓	Second motor set-up	✓
Inertia compensation	✓	Relay control	✓	Speed feedback via options	✓
Auto-tune static	✓	Mechanical brake controller	✓	Field voltage control mode	✓
Auto-tune rotating	✓	Keypad button assignment	✓	Position controller	✓

# SPECIFICATION

## Mentor MP

Items supplied with the drive	The drive is supplied with a Short Form Guide, a SMARTCARD, safety information, grounding bracket, power terminal shrouds (for sizes 1, 2A and 2B) and mounting feet brackets for size 1 drives.
Storage temperature	-40°C to 55°C, -40°F to 131°F
Operating temperature without de-rate	0°C to 40°C, 32°F to 104°F
Operating temperature with de-rate	0°C to 55°C, 32°F to 131°F
Supply requirements	Maximum supply imbalance: 2% negative phase sequence (equivalent to 3% voltage imbalance between phases). Input frequency 45 to 65Hz
Switching frequency range	N/A
Approvals	CE (European Union), cUL Listed (USA and Canada), KC (Korea), RCM (Australia/ New Zealand), EAC (Russian Customs Union)
Product safety standard	EN61800-5-1
Functional safety (Dual STO function)	N/A
Altitude	1000m – No de-rate. 1000m to 3000m - 1% de-rate/100m
Humidity	95% Non-condensing at 40°C
Pollution	Degree 2. Dry, non-conducting pollution only
IP Rating	Frame 1 - IP20 Frame 2A and 2B – IP10 Frame 2C and 2D – IP00
Vibration	Shock test: Referenced standard: BS EN 60068-2-27 Bump Test: Referenced standard: IEC 60068-2-29 Random vibration test: Referenced standard: IEC 60068-2-64 Sinusoidal vibration test: Referenced standard: IEC 60068-2-6, EN 61800-5-1:2007
Mounting methods	Surface mount
Output frequency/speed range	N/A
Braking	Regen braking with four quadrant drives.
Operating modes	Estimated speed (open loop), tacho feedback (closed loop) and encoder feedback (closed loop)
Overload capability	150% for 30seconds
Overvoltage category	IEC 60664-1. Evaluated for OVC III.

<b>Corrosive environments</b>	Referenced standard: EN 50178:1998: Table A2 Referenced standard: IEC 60721-3-3 Class 3C2
<b>Immunity compliance</b>	IEC61800-3, IEC 61000-4-2, IEC 61000-4-3, IEC61000-4-4, IEC61000-4-5, IEC61000-4-6, IEC61000-4-8, IEC61000-4-11, IEC61000-6-1, IEC 61000-6-2.
<b>Emission compliance</b>	Capable of meeting the requirements of Equipment Category C3 without external filters or line reactors. Capable of meeting the requirements of Equipment Category C2 when installed with the recommended filters and line reactors. IEC61800-3, IEC61800-6-3, IEC61000-6-4
<b>Cooling</b>	Forced cooled
<b>Safe Torque off</b>	N/A
<b>Communications</b>	RS485, EtherCAT, PROFIBUS, Ethernet, DeviceNET, CANopen, Interbus
<b>Control I/O</b>	3 x Analogue input, 2 x Analog output, 3 x Digital I/O programmable, 4 x Digital input, 2 x NO relay 250Vac Max., 6 x 0V common, 1 x 24V user output, 1 x 10V user output, 1 x 24V external input. Additional I/O available with SM-I/O option modules.
<b>Resolution/Accuracy</b>	Analogue input 1: 14 bits plus sign, Analogue input 2 and 3: 10 bits plus sign. Analog output: 10 bits plus sign. Speed control typically 5% in estimated speed mode and dependent on the feedback device in closed loop mode. Current control typical 5%.
<b>On-Board user program capability</b>	6kB
<b>Keypad</b>	LED keypad, LCD keypad
<b>PC Tools</b>	'CTSoft' commissioning and cloning tool
<b>Warranty</b>	2 years
<b>Supported options</b>	RS485-Communications lead, SM-EtherCAT, SM-PROFIBUS, SM-Ethernet, SM-DeviceNET, SM-CANopen, SM-I/O Plus, SM-I/O 32, SM-I/O Lite, SM-I/O Timer, SM-I/O PELV, SM-I/O 120V, SM-I/O 24V Protected, SM-Universal Encoder Plus, SM-Encoder Plus, SM-Encoder Output Plus, Single ended encoder interface, SM-Applications Plus, SM-Applications Lite V2 SM-Register, FXMP25 (25A field controller).
<b>Accessories</b>	External EMC filters, Grounding bracket (supplied with the drive)

# DIMENSIONS

Frame Size	Overall Dimensions						Mounting Dimensions				Mounting Hole Diameter		Weight	
	mm			in			mm		in		mm	in	kg	lb
	H	W	D	H	W	D	H	W	H	W				
1A	444	293	222	17.48	11.54	8.74	380	170	14.96	6.69	6.6	0.26	10.5	23.1
1B	444	293	251	17.48	11.54	9.88	380	170	14.96	6.69	6.6	0.26	13	28.7
2A	640	495	301	25.2	19.49	11.85	225	472	8.86	18.58	9	0.35	38	83.8
2B	640	495	301	25.2	19.49	11.85	225	472	8.86	18.58	9	0.35	46	101.4
2C	1050	555	611	41.34	21.85	24.06	605	394	23.82	15.51	11	0.43	100	220.5
2D	1510	555	611	59.45	21.85	24.06	1065	394	41.93	15.51	11	0.43	138	304.2



# CONNECTIONS

\*Thermistor is not selected with USA defaults

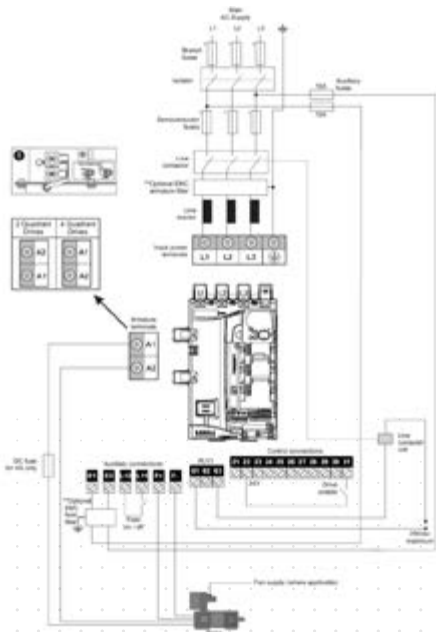

Typical Power Connections

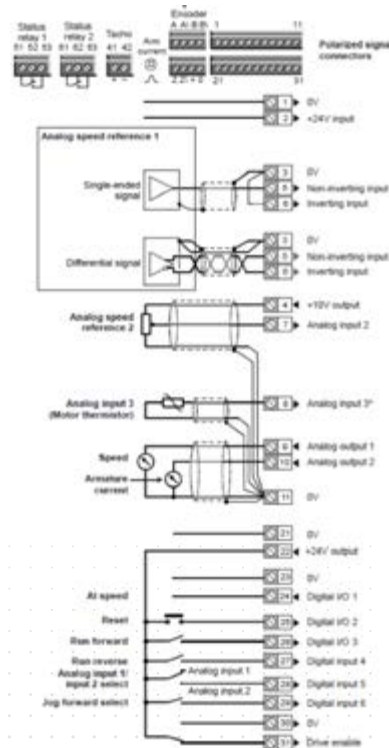

Default Control Connections

# PART NUMBERS

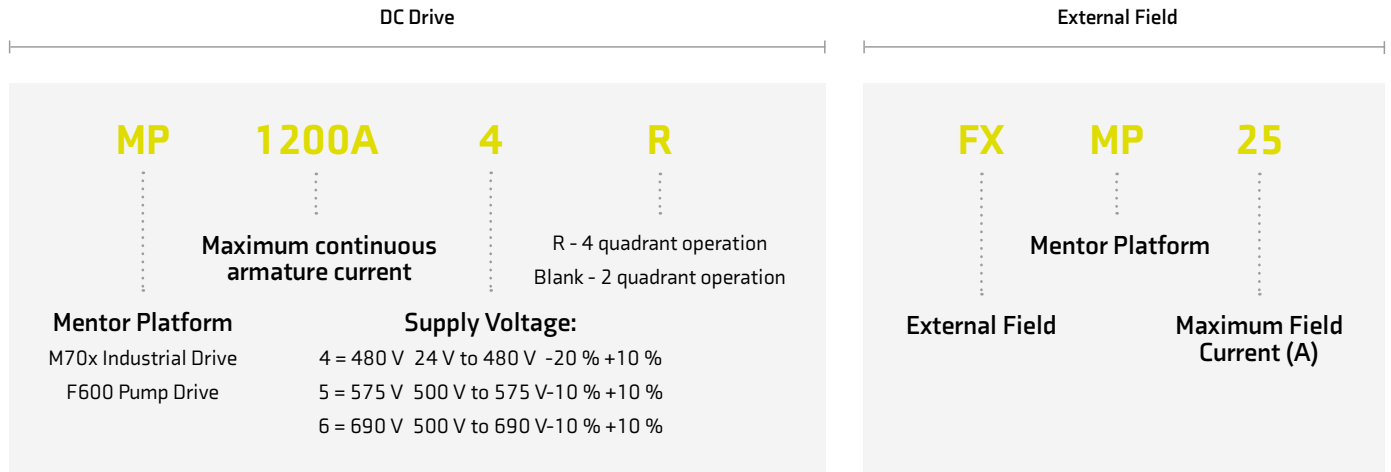

**Note:** At the time of ordering, please select the required interface option.

# MODEL NUMBER AND RATINGS

Model Number	Frame Size	Max. Armature Current	Motor Power		Max. Field Current
		(A)	(kW)	(HP)	(A)
MP25A4(R)	1A	25	9	15	8
MP45A4(R)	1A	45	15	27	8
MP75A4(R)	1A	75	27	45	8
MP105A4(R)	1B	105	37.5	60	8
MP155A4(R)	1B	155	56	90	8
MP210A4(R)	1B	210	75	125	8
MP350A4(R)	2A	350	125	200	20
MP420A4(R)	2A	420	150	250	20
MP550A4(R)	2A	550	200	300	20
MP700A4(R)	2B	700	250	400	20
MP825A4(R)	2B	825	300	500	20
MP900A4(R)	2B	900	340	550	20
MP1200A4(R)	2C/D	1200	450	750	20



Model Number	Frame Size	Max. Armature Current	Motor Power		Max. Field Current
		(A)	(kW)	(HP)	(A)
MP1850A4(R)	2C/D	1850	700	1150	20
MP25A5(R)	1A	25	14	18	8
MP45A5(R)	1A	45	25	33	8
MP75A5(R)	1A	75	42	56	8
MP105A5(R)	1B	105	58	78	8
MP155A5(R)	1B	155	88	115	8
MP210A5(R)	1B	210	120	160	8
MP350A5(R)	2A	350	195	260	20
MP470A5(R)	2A	470	265	355	20
MP700A5(R)	2B	700	395	530	20
MP825A5(R)	2B	825	465	620	20
MP1200A5(R)	2C/D	1200	680	910	20
MP1850A5(R)	2C/D	1850	1045	1400	20
MP350A6(R)	2A	350	240	320	20
MP470A6(R)	2A	470	320	425	20
MP700A6(R)	2B	700	480	640	20
MP825A6(R)	2B	825	650	850	20
MP1200A6(R)	2C/D	1200	850	1150	20
MP1850A6(R)	2C/D	1850	1300	1750	20

## Documentation & Downloads

Product documentation and PC tools available for download from:  
[www.controltechniques.com/support](http://www.controltechniques.com/support)

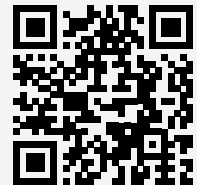

# INDUSTRIAL CONTROL

# PRODUCTS IN THIS RANGE

PLC CONTROLLED MOTION | MCH040, MCH070, MCHMOBILE |  
REMOTE I/O & ETHERCAT I/O | INTEGRATION MODULES

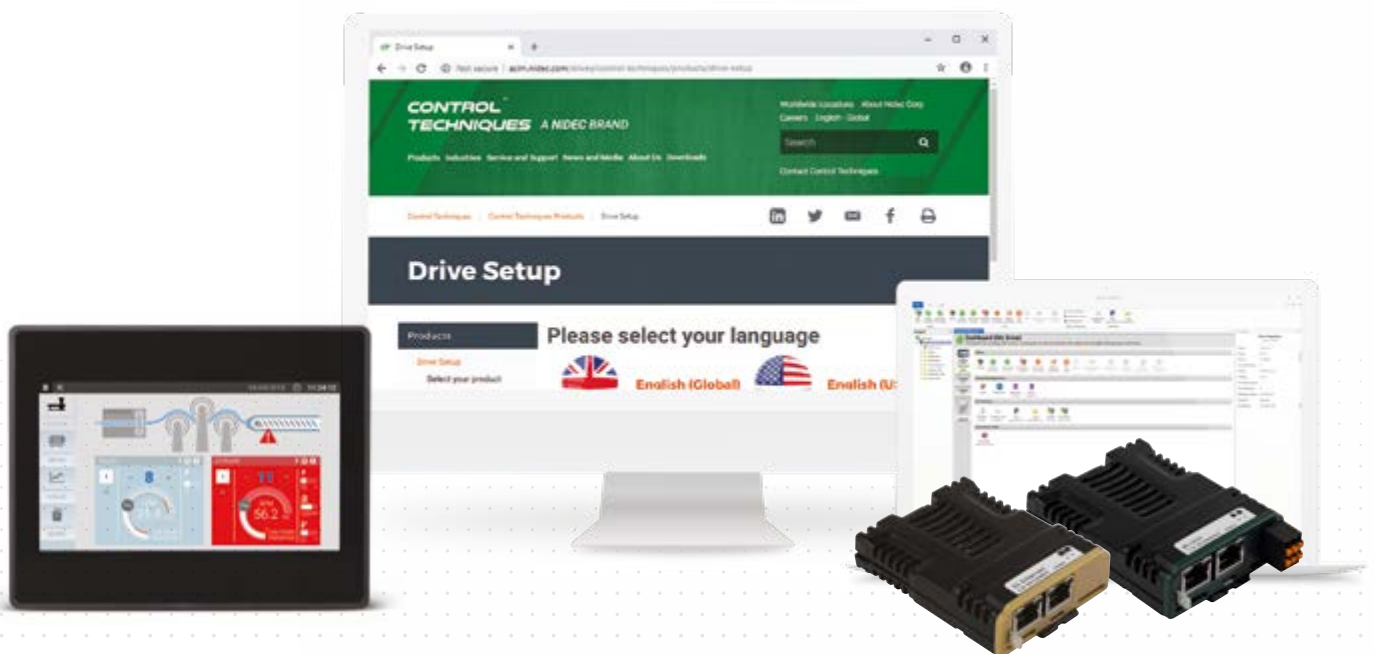

# PLC CONTROLLED MOTION SIMPLIFIES THE INTEGRATION OF DRIVES INTO MAJOR SYSTEMS

**Control Techniques has set the standards in motor control since 1973.**

Composed of two parts, a function block for the PLC and a guided setup within the Connect PC tool, the process of creating the PLC control logic and configuring the powerful onboard motion capabilities of the drive is greatly simplified.

## Application Benefits

**Utilising the high-performance Advanced Motion Controller (AMC) inside the drive not only yields significant performance benefits but gives the possibility to create complex and high-performance motion without the need to use very powerful PLCs.**

All common control and commissioning parameters can be adjusted from the PLC reducing the need to leave the programming environment.

Ladder logic is used extensively in the implementation to ease understanding and facilitate debugging of the application logic. A level of customisation is also possible by the application developer should the function blocks provided not quite meet the needs of the application.



## Installation and Configuration

**A single installation will load all the function blocks and documentation required, as well as example projects to get the application up and running as quickly as possible.**

Also included, is a library of utility function blocks that may be used to further reduce application development time.

PLC Controlled Motion fully configures the Ethernet/IP links thus reducing setup time and leaving more time to focus on the application development.

### Motion configuration

Five function blocks provide functionality to support applications across the motion spectrum.

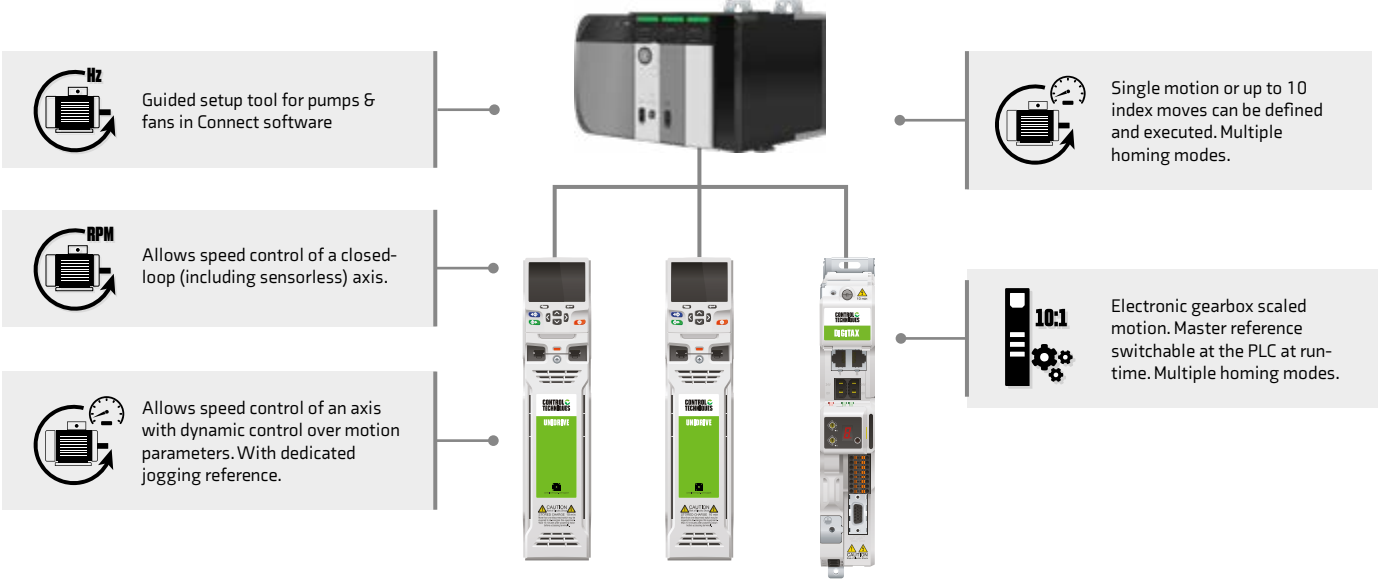

### Machine mechanics

Entering the machine mechanics allows the use of user selectable units across the application; removing the burden of scaling calculations.



PLC controlled motion will guide you through the steps needed to easily configure your application.

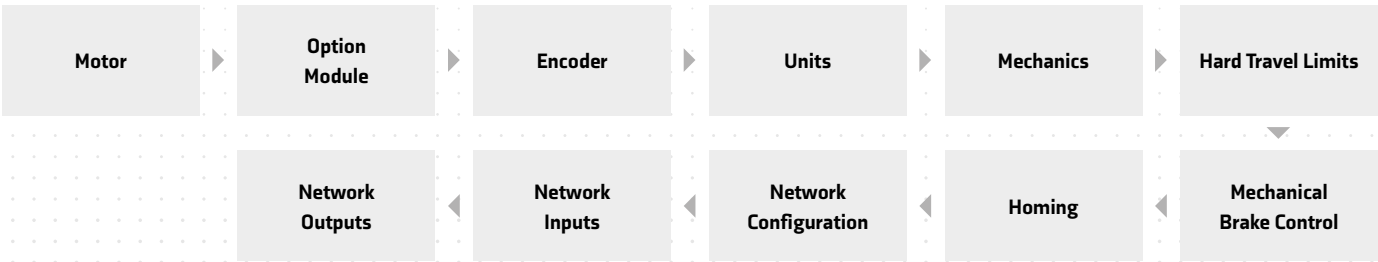

# HMI PANELS AND SOFTWARE

# POWERFUL, FLEXIBLE

# AND EASY TO USE

MCh040 | MCh070 | MChMOBILE

**Control Techniques has set the standards in motor control since 1973.**

The MCh040 & MCh070 panels and MChMobile Software have been designed for the easy development of HMI applications including factory and building automation.

MCh040 features a bright 4.3" TFT widescreen (16:9) display and MCh070 features a bright 7" TFT widescreen (16:9) display with a fully dimmable LED backlight.



## Key Benefits



Full vector graphic support. Native support of SVG graphic objects, transparency and alpha blending.



Multi-language applications with TrueType fonts. Easily create, install and maintain applications in multiple languages to meet global requirements.



Rich set of state-of-the-art HMI features: data acquisition and logging, trend presentation, alarm handling, scheduler and timed actions (daily and weekly schedulers, exception dates), recipes, security and user management, e-mail and RSS feeds.



Screen object dynamics: control visibility and transparency, move, resize and rotate any object on screen. Change properties of basic and complex objects.



Powerful scripting language for automating HMI applications. Efficient script debugger improves productivity in application development.



Wide selection of communication drivers available to communicate with our drives with multiple-driver communication capability.



Data display in numerical, text, bargraph, analogue gauges and image formats.



Remote monitoring and control with Client-Server functionality.



Off-line and on-line simulation.



Rich gallery of objects and symbols.

### Standard Modbus

- Modbus RTU
- Modbus RTU server
- Modbus TCP
- Modbus TCP server

### CT Modbus

- CT Modbus TCP

### Others

- OPC UA Client

# SPECIFICATION

System Resources	MCh040	MCh070
Display - Colors	4.3" TFT 16:9 - 64K	7" TFT 16:9 - 64K
Resolution	480x272	800x480, WVGA
Brightness	200 Cd/m <sup>2</sup> typ.	200 Cd/m <sup>2</sup> typ.
Dimming	Yes	Yes
Touchscreen	Resistive	Resistive
CPU	ARM Cortex-A8 - 300 MHz	ARM Cortex-A8 - 1 GHz
Operating System	Linux 3.12	Linux 3.12
Flash	2 GB	4 GB
RAM	256 MB	512 MB
Real Time Clock, RTC Back-up, Buzzer	Yes	Yes
Interface		
Ethernet port	1 (port 0 - 10/100)	1 (port 0 - 10/100)
USB port	1 (Host v.2.0, max. 500 mA)	1 (Host v.2.0, max. 500 mA)
Serial port 1	1 (RS-232, RS-485, RS-422, software configurable)	1 (RS-232, RS-485, RS-422, software configurable)
SD card	No	No
Expansion	No	No
Ratings		
Power supply	24 Vdc (10 to 32 Vdc)	24 Vdc (10 to 32 Vdc)
Current Consumption	0.25 A max. at 24 Vdc	0.3 A max. at 24 Vdc
Input Protection	Automatic	Automatic
Battery	Yes (Supercapacitor)	Yes (Supercapacitor)
Environment Conditions		
Operating Temperature	0 to 50 °C (vertical installation)	0 to 50 °C (vertical installation)
Storage Temperature	-20°C to +70°C	-20°C to +70°C
Operating / Storage Humidity	5-85% RH, non condensing	5-85% RH, non condensing
Protection Class	IP66, Type 2 and 4X (front); IP20 (rear)	IP66, Type 2 and 4X (front); IP20 (rear)
Approvals		
CE	Emission EN 61000-6-4, Immunity EN 61000-6-2 for installation in industrial environments Emission EN 61000-6-3, Immunity EN 61000-6-1 for installation in residential environments	
UL	cULus: UL508	cULus: UL508
UL	cULus: Class 1 Div 2	cULus: Class 1 Div 2



# DIMENSIONS & WEIGHTS

	MCh040	MCh070
Faceplate LxH	147x107 mm (5.78x4.21")	187x147 mm (7.36x5.79")
Cutout AxB	136x96 mm (5.35x3.78")	176x136 mm (6.93x5.35")
Depth D+T	29+5 mm (1.14+0.19")	29+5 mm (1.14+0.19")
Weight	Approx 0.4 kg	Approx 0.6 kg

# MODEL NUMBER

Ordering Guide	MCh040	MCh070
Part number	eSMART04-MCh040	eSMART07M-MCh070

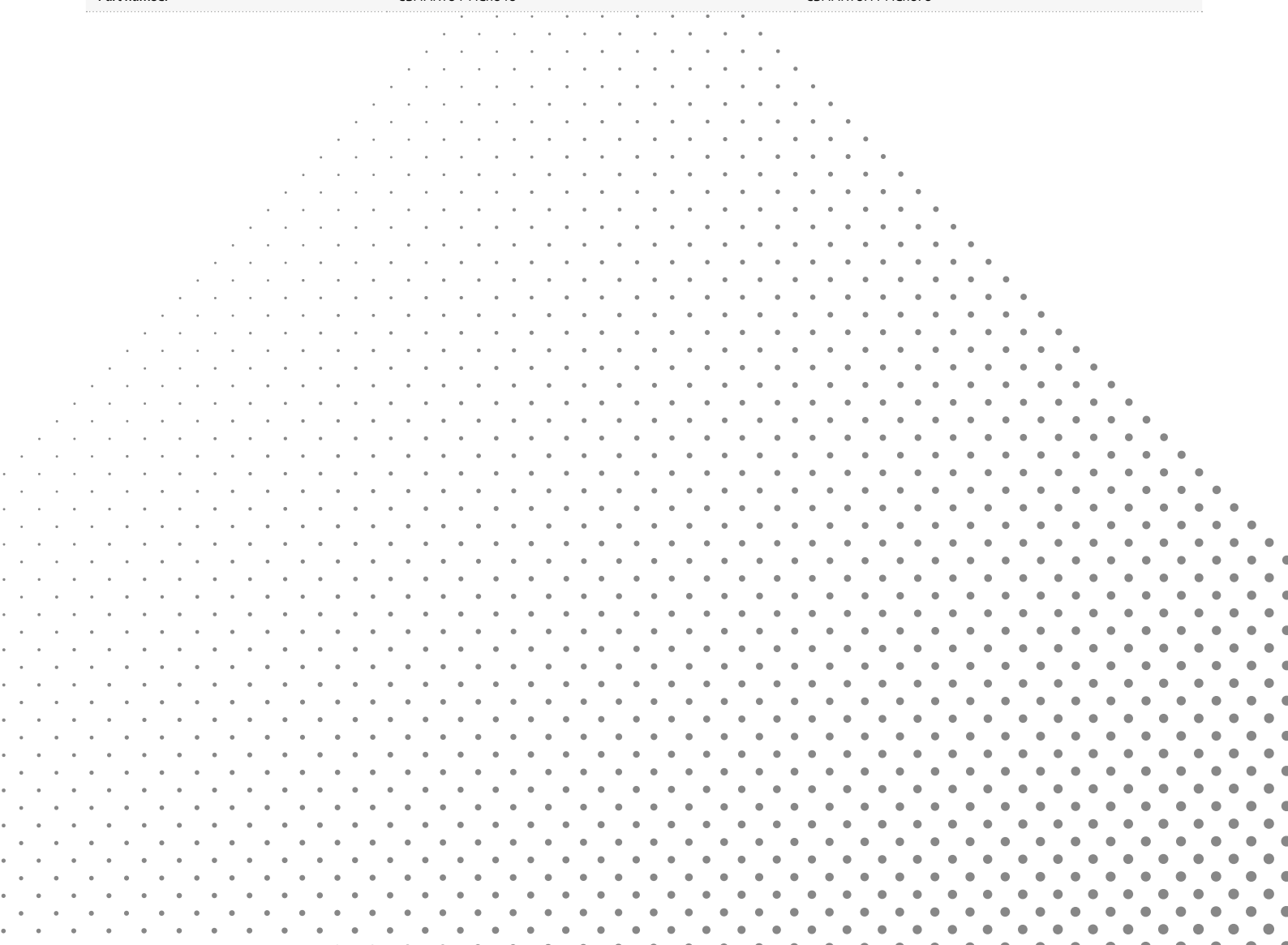

# ETHERCAT REMOTE I/Os

# EASY CONNECTION

# OF ANALOGUE AND

# DIGITAL INPUT &

# OUTPUT SIGNALS

## I/O Modules enable industrial automation control

Industrial automation control applications often use a PLC system to manage the process, using I/O to communicate with sensors attached to the machines involved.

Control Techniques now have a series of EtherCAT Remote I/O modules that can be used with our own or any other brand PLC/Controllers.



## EtherCAT Remote I/Os

In this configuration, add-on EtherCAT Remote I/O modules connect via the on-board EtherCAT port of the MCE or MCz controllers, or through any EtherCAT port on any PLC or controller.

A typical scalable configuration (as shown below) would feature the EtherCAT Remote I/O module, used together with MCE or MCz controllers, MCI2XX Machine Control option modules, Machine Control Studio software and the MCh040/MCh070 HMI Panels. All sensor inputs and outputs can be controlled, including LEDs, pushbuttons, temperature controls, machine status indicators and fluid flow sensors.

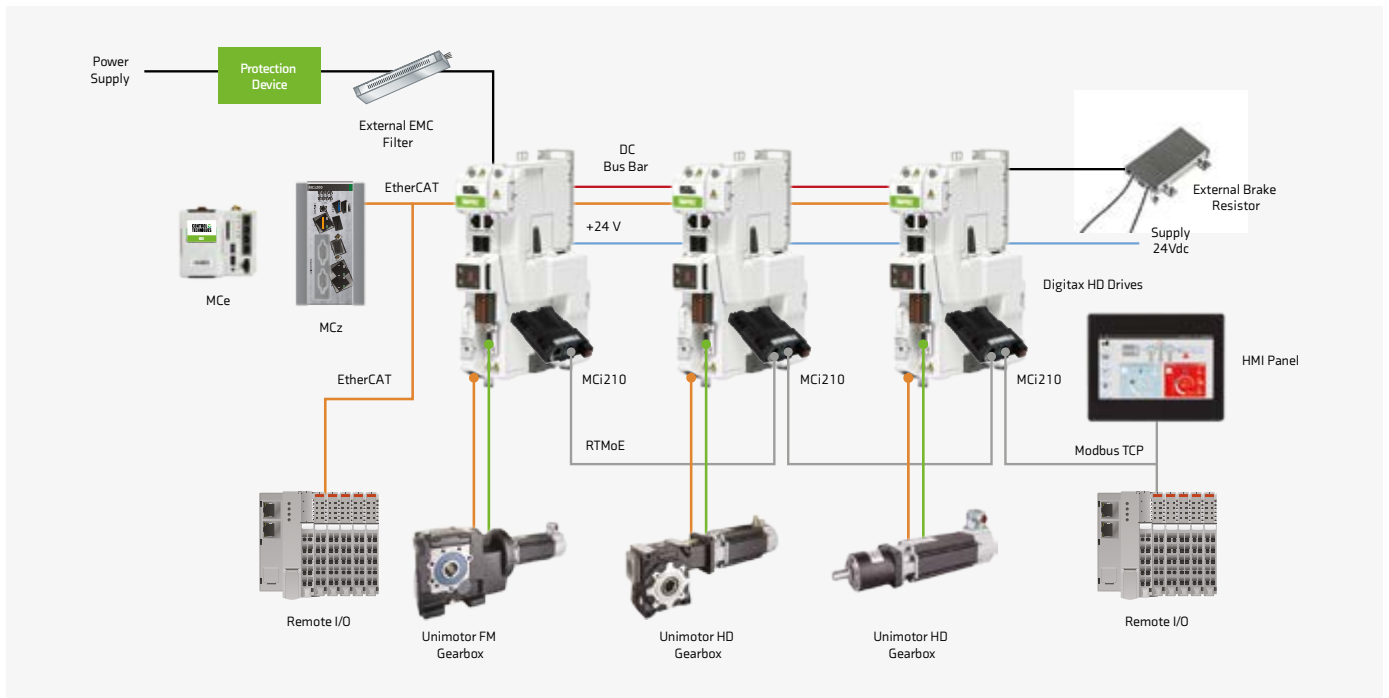

### Supported slices and model number

Network Adapter	Part Number
EtherCAT Network Adapter	IO201-BC
System Module	Part Number
8 Channels, Shield Module, ID Type, 10RTB	RT-7008
8 Channels, Common Module, 0 Vdc, ID Type, 10RTB	RT-7108
1 Channel, Expansion Power, Input 24 Vdc, Output 1.0 A/5 Vdc, ID Type, 10RTB	RT-7111
8 Channels, Common Module, 24 Vdc, ID Type, 10RTB	RT-7118
8 Channels, Common, 0V dc/24 Vdc, ID Type, 10RTB	RT-7188
Field Power Distribution, 5Vdc, 24Vdc, 48Vdc, 110Vac, 220Vac, ID Type, 10RTB	RT-7241
Digital Input	Part Number
DI 8 PTs, Universal (Sink or Source), 24Vdc, 10RTB	RT-1238
DI 16 PTs, Universal (Sink or Source), 24Vdc, 18RTB	RT-12DF
DI 32 PTs, Universal (Sink or Source), 24Vdc, 40PTs Connector	RT-12FA
Digital Output	Part Number
DO 8 PTs, Sink, 24Vdc/0.5A, 10RTB	RT-2318
DO 8 PTs, Source, 24Vdc/0.5A, 10RTB	RT-2328
DO 16 PTs, Sink, 24Vdc/0.3A, 18RTB	RT-225F
DO 16 PTs, Source, 24Vdc/0.3A, 18RTB	RT-226F
DO 32 PTs, Sink, 24Vdc/0.3A, 40PTs Connector	RT-22BA
DO 32 PTs, Source, 24Vdc/0.3A, 40PTs Connector	RT-22CA
Relay Output 4 PTs, 24Vdc/2A, 240Vac/2A, 10RTB	RT-2744

Analogue Input	Part Number
AI, 4 CHs, 0~20, 4~20mA, 12Bits, 10RTB	RT-3114
AI, 4 CHs, 0~20, 4~20mA, 16Bits, 10RTB	RT-3154
AI, 8 CHs, 0~20, 4~20mA, 12Bits, 10RTB	RT-3118
AI, 4 CHs, 0~10, 0~5, 1~5Vdc, 12Bits, 10RTB	RT-3424
AI, 4 CHs, 0~10, 0~5, 1~5Vdc, 16Bits, 10RTB	RT-3464
AI, 8 CHs, 0~10, 0~5, 1~5Vdc, 12Bits, 10RTB	RT-3428
AI, 4 CHs, RTD, 10RTB	RT-3704
AI, 4 CHs, Thermocouple, 10RTB	RT-3804
Differential type, 4 CHs, 0~20, 4~20, +/-20mA, 12Bits, 10RTB	RT-3914
Differential type, 4 CHs, 0~20, 4~20, +/-20mA, 16Bits, 10RTB	RT-3934
Differential type, 4 CHs, 0~5, 0~10, +/-5, +/-10Vdc, 12Bits, 10RTB	RT-3924
Differential type, 4 CHs, 0~5, 0~10, +/-5, +/-10Vdc, 16Bits, 10RTB	RT-3944
Analogue Output	Part Number
AO, 4 CHs, 0~20mA, 12Bits, 10RTB	RT-4114
AO, 4 CHs, 0~20mA, 16Bits, 10RTB	RT-4154
AO, 8 CHs, 0~20mA, 12Bits, 10RTB	RT-4118
AO, 8 CHs, 0~20mA, 16Bits, 10RTB	RT-4158
AO, 4 CHs, 0~10Vdc, 12Bits, 10RTB	RT-4424
AO, 4 CHs, 0~10Vdc, 16Bits, 10RTB	RT-4464
AO, 8 CHs, 0~10Vdc, 12Bits, 10RTB	RT-4428
AO, 8 CHs, 0~10Vdc, 16Bits, 10RTB	RT-4468

# RTMOE OR MODBUS TCP REMOTE I/Os THE MOST WIDELY USED NETWORK PROTOCOL

## I/O Modules enable industrial automation control without PLCI

Industrial automation control applications often use a PLC system to manage the process, using I/O to communicate with sensors attached to the machines involved.

Now, a series of I/O modules is available for Control Techniques' drives. They are designed to enable applications of moderate complexity to be managed without the need for a PLC system, but directly using the drive itself.



## RTMoE or Modbus TCP Remote I/Os

In this configuration, add-on RTMoE or Modbus TCP Remote I/O modules connect directly via the on-board Ethernet port of the M7XX series drives, or via the on-board Ethernet port of the MCI210 Machine Control option modules.

A typical configuration (as shown below) would include MCI2XX Machine Control option modules, Machine Control Studio software and the MCh040/MCh070 HMI Panels. All sensor inputs and outputs can be controlled, including LEDs, pushbuttons, temperature controls, machine status indicators and fluid flow sensors.

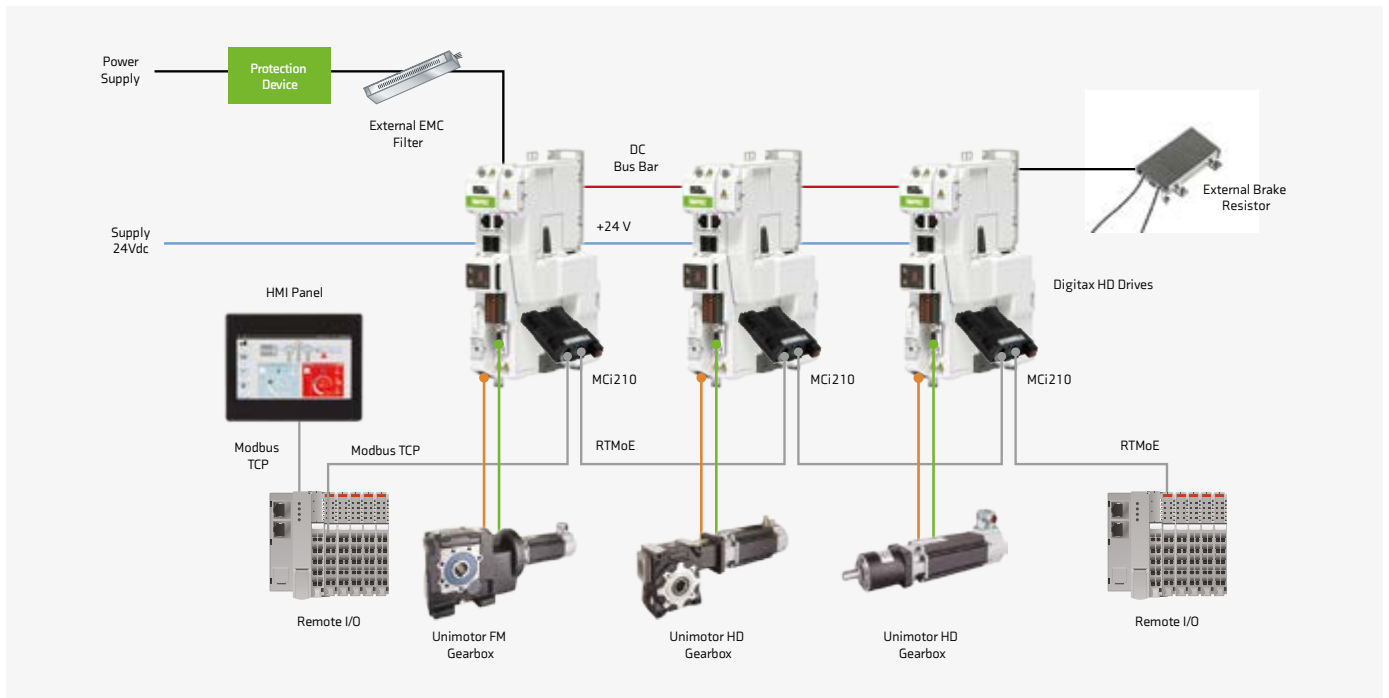

## Supported slices and model number

Network Adapter	Part Number
RTMoE & MODBUS TCP Network Adapter	IO210-BC
System Module	Part Number
8 Channels, Shield Module, ID Type, 10RTB	GT-7408
8 Channels, Common Module, 0 Vdc, ID Type, 10RTB	GT-7508
1 Channel, Expansion Power, Input 24 Vdc, Output 1.0 A/5 Vdc, ID Type, 10RTB	GT-7511
8 Channels, Common Module, 24 Vdc, ID Type, 10RTB	GT-7518
8 Channels, Common, 0V dc/24 Vdc, ID Type, 10RTB	GT-7588
Field Power Distribution, 5Vdc, 24Vdc, 48Vdc, 110Vac, 220Vac, ID Type, 10RTB	GT-7641
Digital Input	Part Number
DI 8 PTs, Universal (Sink or Source), 24Vdc, 10RTB	GT-1238
DI 16 PTs, Universal (Sink or Source), 24Vdc, 18RTB	GT-12DF
DI 32 PTs, Universal (Sink or Source), 24Vdc, 40PTs Connector	GT-12FA
Digital Output	Part Number
DO 8 PTs, Sink, 24Vdc/0.5A, 10RTB	GT-2318
DO 8 PTs, Source, 24Vdc/0.5A, 10RTB	GT-2328
DO 16 PTs, Sink, 24Vdc/0.3A, 18RTB	GT-225F
DO 16 PTs, Source, 24Vdc/0.3A, 18RTB	GT-226F
DO 32 PTs, Sink, 24Vdc/0.3A, 40PTs Connector	GT-22BA
DO 32 PTs, Source, 24Vdc/0.3A, 40PTs Connector	GT-22CA
Relay Output 4 PTs, 24Vdc/2A, 240Vac/2A, 10RTB	GT-2744

Analogue Input	Part Number
AI, 4 CHs, 0~20, 4~20mA, 12Bits, 10RTB	GT-3114
AI, 4 CHs, 0~20, 4~20mA, 16Bits, 10RTB	GT-3154
AI, 8 CHs, 0~20, 4~20mA, 12Bits, 10RTB	GT-3118
AI, 8 CHs, 0~20, 4~20mA, 16Bits, 10RTB	GT-3158
AI, 4 CHs, 0~10, 0~5, 1~5Vdc, 12Bits, 10RTB	GT-3424
AI, 4 CHs, 0~10, 0~5, 1~5Vdc, 16Bits, 10RTB	GT-3464
AI, 8 CHs, 0~10, 0~5, 1~5Vdc, 12Bits, 10RTB	GT-3428
AI, 8 CHs, 0~10, 0~5, 1~5Vdc, 16Bits, 10RTB	GT-3468
AI, 4 CHs, RTD, 10RTB	GT-3704
AI, 4 CHs, Thermocouple, 10RTB	GT-3804
Differential type, 4 CHs, 0~20, 4~20, +/-20mA, 12Bits, 10RTB	GT-3914
Differential type, 4 CHs, 0~20, 4~20, +/-20mA, 16Bits, 10RTB	GT-3934
Differential type, 4 CHs, 0~5, 0~10, +/-5, +/-10Vdc, 12Bits, 10RTB	GT-3924
Differential type, 4 CHs, 0~5, 0~10, +/-5, +/-10Vdc, 16Bits, 10RTB	GT-3944
Analogue Output	Part Number
AO, 4 CHs, 0~20mA, 12Bits, 10RTB	GT-4114
AO, 4 CHs, 0~20mA, 16Bits, 10RTB	GT-4154
AO, 8 CHs, 0~20mA, 12Bits, 10RTB	GT-4118
AO, 8 CHs, 0~20mA, 16Bits, 10RTB	GT-4158
AO, 4 CHs, 0~10Vdc, 12Bits, 10RTB	GT-4424
AO, 4 CHs, 0~10Vdc, 16Bits, 10RTB	GT-4464
AO, 8 CHs, 0~10Vdc, 12Bits, 10RTB	GT-4428
AO, 8 CHs, 0~10Vdc, 16Bits, 10RTB	GT-4468

# PTi210 POWERTOOLS MOTION MADE EASY®

More than 45 years later, we're still in pursuit of the best Motion Made Easy for servo motion control applications. Enter our next generation of Motion Made Easy for Digitax HD and Unidrive M servo drive platforms. The PTi210 enables Control Techniques' PowerTools Studio software interface.

Setup complex applications within minutes. It's flexible, versatile and up to whatever challenging application you want to throw at it.



## PTi210 PowerTools Integration Module

**PTi210 is a cost effective way to provide simple, fast and effective motion control solutions.**

- Precise reliable motion controller
- 5 high speed digital I/O points (3 inputs & 2 outputs) in addition to the on-board drive I/O
- 1.5 axis synchronized encoder following with an optional encoder system integration module
- Rapid integration for applications such as:
  - Conveyor Synchronization
  - Parts Alignment
  - Rotary Knife
  - Electronic Gearing
  - Phase Synchronization
  - Slip Compensation
  - Feed to Sensor/Torque
  - Point-To-Point Positioning
  - Thermoforming
  - Flying Cutoff
  - Product Spacing
  - Traverse Winding
  - Labelling and Printing
  - Random Infeed Control
  - Web Control
  - Multi-Lane Merge Control
  - Registration Control

**and many more!**

# PowerTools Studio software

PowerTools Studio provides an unparalleled setup and commissioning experience suitable for all skill levels. Professional motion control software engineers, infrequent users, or someone with no servo experience can equally use this interface to program drives.

- Easily program the Digitax HD or Unidrive M using a Modbus RTU serial port or on-board Ethernet depending on your model
- Simple configuration and programming visual interface
  - Fill-in-the-blank
  - Point-and-Click
  - Drop down menu selection
  - Drag-and-Drop parameters and I/O assignments
- Instant access to all parameters through the project tree view
- As always with Control Techniques, the software is freely available for download.

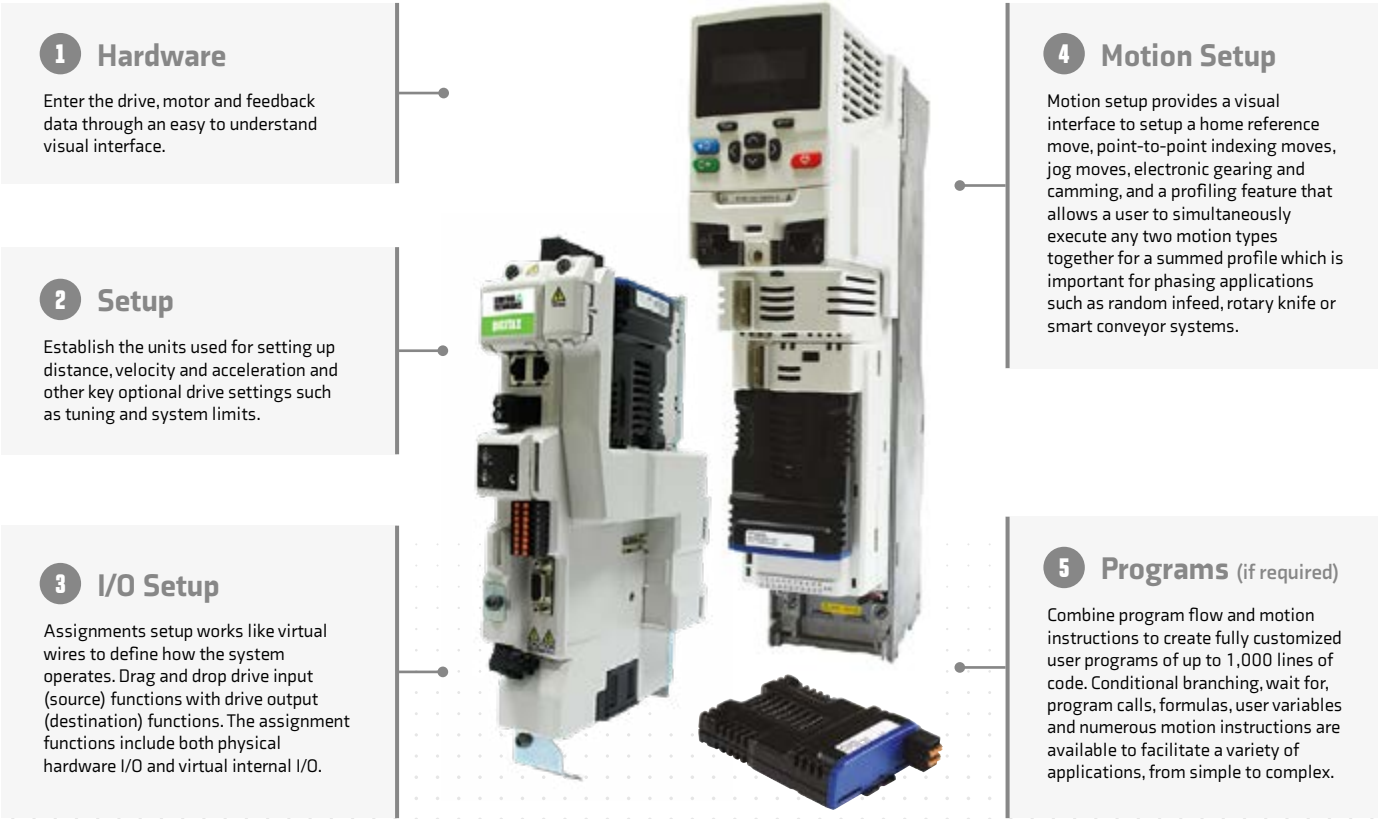
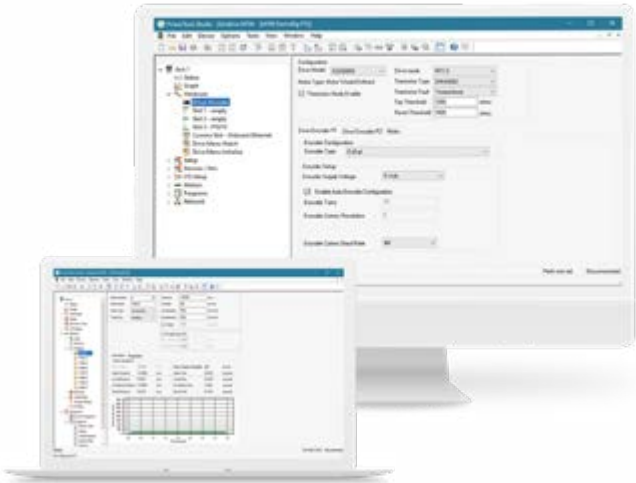

## APPLICATIONS

# SI-APPLICATIONS PLUS SI-APPLICATIONS COMPACT

**SI-Applications modules allow SyPTPro application programs to be recompiled and executed with Unidrive M700 and Digitax HD to enable rapid and simple upgrade to users.**

Applications comprising networked drives with SM-Applications using CTNet or CTSync for real-time control can be quickly replaced with Unidrive M and Digitax HD and the SI-Applications module without any compromise to system performance.



### **SI-Applications Plus**

Can be used with Unidrive M only  
in option slot 3



### **SI-Applications Compact**

Can be used with Unidrive M and  
Digitax HD in any option slot



**Features include:**

- Enhanced high speed dedicated microprocessor
- 384 kB Flash memory for user program
- 80 kB user program memory
- EIA-RS485 port offering ANSI, Modbus-RTU follower and master and Modbus-ASCII follower and master protocols
- CTNet high speed network connection offering up to 5 Mbit/s data rate
- Two 24 V digital inputs
- Two 24 V digital outputs
- Task based programming system for real-time control
- CTSync distributes a master position to multiple drives on a network. Hardware synchronization of speed, position and torque loops achieving a time base of 250 μs

**Terminal Descriptions**

Terminal	Function	Description
1	0 V SC	0 V connection for EIA-RS485 port
2	/RX	EIA-RS485 Receive line (negative). Incoming
3	RX	EIA-RS485 Receive line (positive). Incoming
4	/TX	EIA-RS485 Transmit line (negative). Outgoing
5	TX	EIA-RS485 Transmit line (positive). Outgoing
6	CTNET A	CTNet data line
7	CTNET Shield	Shield connection for CTNet
8	CTNET B	CTNet data line
9	0 V	0 V connection for digital I/O
10	DIO	Digital input 0
11	DI1	Digital input 1
12	DO0	Digital output 0
13	DO1	Digital output 1

# MCi200 & MCi210

# MACHINE CONTROL MODULES

**Unidrive M's MCi200 and MCi210 modules extend machine control capability when combined with the Advanced Motion Controller embedded in Unidrive M700.**

Enabling easy connectivity of additional machine components and application software, MCi200 and MCi210 create a complete application solution. As a result of the highly flexible plug-in option module format, system design is streamlined by removing the need for PLCs and additional external equipment. Machine control is fast and easy to achieve thanks to Unidrive M's user friendly programming software - Machine Control Studio - utilizing the industry-standard open IEC 61131-3 programming environment.

## **Build high performance systems and productive machines**

- MCi modules execute comprehensive programs that can control multiple drives and motors simultaneously across real-time networks.
- M700's onboard Ethernet using RTMoE (Real Time Motion over Ethernet) provides synchronization and communication between drives using the Precision Time Protocol as defined by IEEE1588 V2.
- Performance is optimized by having a motion controller embedded in each networked drive.



**MCi200**



**MCi210**

The MCI200 and MCI210 machine control modules provide:

- **High performance machine control:** High speed communications of 250 µs enables optimum performance.
- **High bandwidth:** Control multiple drive and motor axes thanks to MCI210's second Ethernet port.
- **Optimum ease of use:** Rapidly create machine control programs with Unidrive M's programming software, developed with extensive human centred design research and based on the industry-standard IEC 61131-3 programming environment.
- **Open environment:** Standard IEEE 1588 Ethernet and IEC 61131 software enable open machine control programming, boosting the choice of component connectivity.
- **Streamlined machine design:** Plug-in option module format means less wiring, less physical space required & less financial cost, while increasing design simplicity.
- **User programming:** The MCI200 and MCI210 modules are capable of running Machine Control Studio programs. It is an integrated development environment that supports all five of the programming languages of the IEC 61131-3 standard, including Structured Text (ST), Ladder Diagram (LD), Function Block Diagram (FBD), Sequential Function Chart (SFC) and Instruction List (IL). Continuous Function Chart (CFC) is also supported.
- **Optimum connectivity:** Simple integration with external components such as I/O, HMIs and other networked drives can be achieved using Unidrive M's integrated standard Ethernet ports (with RTMoE or standard protocols), or fieldbuses supported by SI option modules (EtherCAT, PROFINET, PROFIBUS, CANopen).

The user has a number of tasks available to them as shown in the following table.

Task	Interval
Initial	Executes once when the user program starts
Freewheeling	No timebase
Clock0	
Clock1	User-specified timebase from 1 ms to 24 hours in 1 ms increments
Clock2	
Clock3	
Position	User-specified timebase from 250 µs to < 8 ms in 250 µs increments
Event0	
Event1	No timebase. This task is triggered (e.g. by the Timer Unit, Ethernet cyclic data etc.)
Event2	
Event3	
ErrorTask	No timebase. This task is triggered on a user program error

MCI210 ensures higher performance by delivering:

- Two additional Ethernet ports with an internal switch
- Support for standard Ethernet protocols, along with RTMoE for PTP (IEEE 1588) synchronization
- Modbus TCP/IP master (up to 5 nodes)
- Parallel interface with drive processor provides faster data exchange
- Machine control over two segregated Ethernet networks enables greater flexibility in machine design
- Extends connectivity with 3 x digital inputs, 1 x digital output and 1 x digital I/O

The Clock and Position tasks are cyclic and will run at an interval set by the user. The Freewheeling task is the lowest priority task and will run when processor resource allows.

# OPTION MODULES

## Communication



SI-Ethernet



SI-EtherCAT



SI-PROFINET V2



SI-CANopen



SI-PROFIBUS



SI-Encoder



SI-Interbus



SI-POWERLINK



SI-DCP



SI-CiA417

**Feedback**



**SI-Encoder**



**SI-Universal Encoder**



**MiS210**



**SI-Safety**

**I/O**



**SI-I/O**

**Safety**

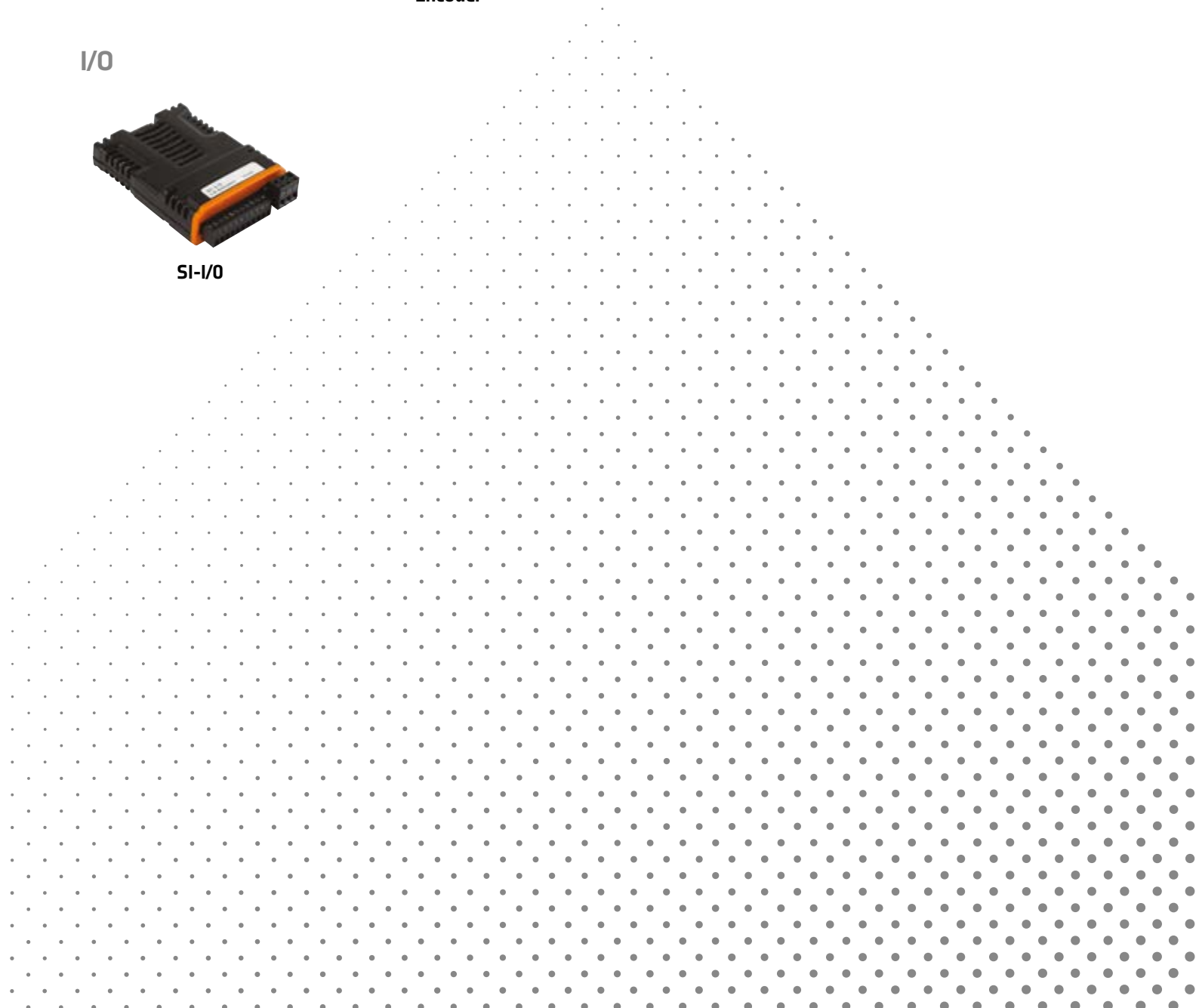

# PC TOOLS

# PRODUCTS IN THIS RANGE

Category	PC Tool/App	Description
Connect	Commissioning/Set-up	Drive Commissioning tool for Uni M, Commander, Powerdrive, Pump Drive, Elevator, HVAC, and Digitax HD.
Connect	Diagnostics	Fault Log, Monitoring, Drive status views.
CT Energy Savings Estimator	Application	Estimates energy consumption for fan and pumps applications when using and AC motor with a CT Drive.
CTSafePro	Safety	Graphical program editor used to prepare function-block programs for the SM & SI safety module.
CTScope	Commissioning/Set-up	CTScope is a single oscilloscope display on which a number of channels can be displayed. A feature set (and look and feel) similar to that of a hardware oscilloscope is provided.
CTScope	Diagnostics	Eight analogue channels (drive or option module parameters) of data can be recorded.
CTSoft	Commissioning/Set-up	Drive commissioning tool for CT Affinity, Unidrive Classic, Unidrive SP, Unidrive ES, Unidrive PV, Commander GP20, Commander SK, Digitax ST series and Mentor MP ranges of drives.
CTSoft	Diagnostics	Fault Log, Monitoring, Drive status views.
Digitax SF Connect	Commissioning/Set-up	3rd party commissioning tool for Digitax SF Drive.
Machine Control Studio	Programming	Machine Control Studio provides a IEC 61131-3 programming environment for the Unidrive M / Commander drive and MCI2x0 option module range from Control Techniques.
Machine Control, Studio	Diagnostics	Trace watch functionality.
PowerTools Pro	Programming	For the Epsilon EP, FM-3E and FM-4E modules, and for Control Techniques' Unidrive SP and Digitax ST-Z drives (with the SM-EZMotion Option Module).. CT-USA Developed product.
PowerTools Pro	Commissioning/Setup	Epsilon EP, FM-3E and FM-4E modules, and for Control Techniques' Unidrive SP and Digitax ST-Z drives (with the SM-EZMotion Option Module).
SyPTLite	Programming	Unidrive, SP, Digitax series, Commander SK Onboard PLC programming tool.
SyPTPro	Programming	SM/SI-Applications / Plus, allows user programs to be developed for multiple nodes in DPL, Ladder and Function Block programming languages. DPL (Drive Programming Language) is a high level language as easy to use as BASIC but optimised for drive applications. SYPT also allows user programs to be downloaded to nodes and the runtime operation of the programs to be monitored. Contains SyPTLite.
MChMobile	Programming	Development of HMI applications with the MCh040 and MCh070 HMI panels.

# ACCESSORIES





# HIGH PERFORMANCE, HIGH SPEED.

## **Integrate, automate, communicate with an extensive range of options**

















Control Techniques' drives support a wide range of optional click-in System Integration modules that allow them to integrate seamlessly with existing Manufacturing Automation systems and other vendor supplied equipment. These include communications, I/O, feedback devices, enhanced safety features and onboard PLCs.

Control Techniques' high performance drives use a high speed parallel bus between the drive and SI modules which removes delays, improving the drive's reaction time. Communications interfaces are independently certified for conformance with the relevant standards to ensure performance and interoperability.













## **Drive installation, set-up, configuration and monitoring**

Our drives are quick and easy to set-up and can be configured using a selection of keypads, SD or Smartcards. We can also provide standard engineered accessories such as external EMC filters (for compliance with EN 61000-6-4) chokes and motor cables. Control Techniques can also provide all the mounting brackets required to meet your specific application requirements whether retrofitting old systems or designing new ones to meet specific IP ratings.













*All of what we offer can be found in the following pages.*

Optimal Drives Programming and Operator Interface	Frame Size	Part No.	Commander C200	Commander C300
Connect			✓	✓
Remote Keypad		82500000000001	✓	✓
Remote keypad RTC		82400000019600	✓	✓
KI-Keypad		82400000016000		
KI-Keypad RTC		82400000016300		
KI-HDA Keypad RTC - Green F600		82400000018500		
KI-Compact Display		82700000020400		
Remote Keypad (LCD)		82400000019700		
Remote HDA Keypad RTC		82400000019700		
CI-Keypad		82500000000000		
MP-Keypad LCD with MP Firmware		82300000015300		
SM-Keypad LED standard		82000000010900		
Operator Interface (HMI)		eSMART04-MCh040 eSMART07M-MCh070	using the AI-485 Adaptor	using the AI-485 Adaptor
REMOTE I/O				
Smartcard		2214-0010		
SD card using SD Card Adaptor		82400000016400		
AI-485 Adaptor		82500000000003		
KI-485 Adaptor		82400000016100		

Unidrive M400	Unidrive M600	Unidrive M700	Elevator Drive E300	Pump Drive F600	Digitax HD	Digitax SF	Mentor MP
✓	✓	✓	✓	✓	✓		✓
	✓	✓	✓				
✓	✓	✓	Recommended		✓		
	✓	✓	✓				
✓	✓	✓	✓	✓			
				✓			
					✓		
✓							
				✓			
✓							
using the AI-485 Adaptor	✓	✓		✓	M753 with an option module		✓
		✓ M700 & M702			✓ M750		
	✓	✓	✓	✓			✓
	✓	✓	✓	✓			
	✓	✓					
			✓	✓			

Optimal Drives Programming and Operator Interface		Frame Size	Part No.	Commander C200	Commander C300
AI-Back-up Adaptor			82500000000004	✓	✓
AI-485 Adaptor			82500000000003	✓	✓
AI-Smart Adaptor			82500000018500	✓	✓
RS485 Cable			4500-0096	✓	✓
AI-485 24 V Adaptor			82500000019700		✓
AI-485 24 V Adaptor			82500000019700		
AI-485 Adaptor			82500000000003	✓	✓
CI-485 Adaptor			82500000000002		
<b>SI Option Modules</b>					
<b>Machine Control</b>					
MCI200			82400000017000		
MCI210			82400000016700		
SI-Applications Plus			82400000016500		
SI-Applications Compact			82400000020700		
PTI210			82400000021400		

Unidrive M400	Unidrive M600	Unidrive M700	Elevator Drive E300	Pump Drive F600	Digitax HD	Digitax SF	Mentor MP
✓							
✓							
✓							
			✓			✓	
✓							
✓							
✓							
		✓	✓	✓		✓	
		✓	✓			✓	
		✓ (Only slot 3)	✓ (Only slot 3)				
		✓ (Only slot 3)	✓ (Only slot 3)			✓	
		✓				✓	

SI Option Modules	Frame Size	Part No.	Commander C200	Commander C300
<b>Safety</b>				
SI-Safety		82400000018400		
MiS210		82400000021100		
<b>Communications</b>				
SI-Ethernet		82400000017900	✓	✓
SI-PROFINET RT V2		82500000018200	✓	✓
SI-EtherCAT		82400000018000	✓	✓
SI-CANopen V2		82400000017600	✓	✓
SI-PROFIBUS		82400000017500	✓	✓
SI-POWERLINK		82400000021600	✓	✓
SI-DeviceNet		82400000017700	✓	✓
SI-Interbus 500kBd		82400000021220	✓	✓
SI-Interbus 2MBb		82400000021230	✓	✓
SI-DCP* *Support of DCP3 & DCP		82400000019900		
SI-CiA417		82400000021700		

Unidrive M400	Unidrive M600	Unidrive M700	Elevator Drive E300	Pump Drive F600	Digitax HD	Digitax SF	Mentor MP
✓	✓						
	✓	✓					
✓	✓	✓	✓	✓	✓		
✓	✓	✓		✓	✓		
✓	✓	✓		✓	✓		
✓	✓	✓	✓	✓	✓		
✓	✓	✓		✓	✓		
✓	✓	✓	✓	✓	✓		
✓	✓	✓		✓	✓		
✓	✓	✓		✓	✓		
			✓				
			✓				

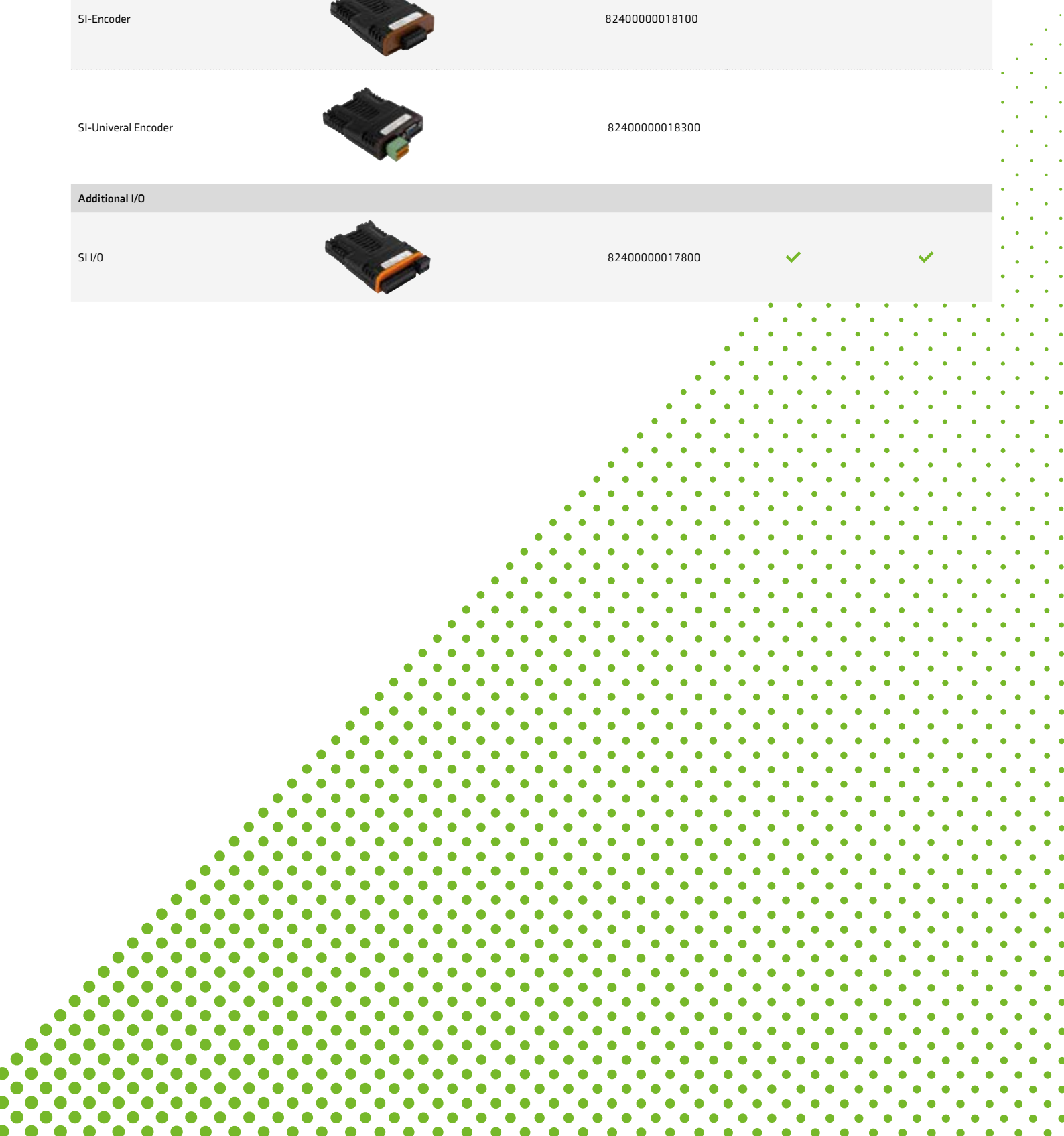

SI Option Modules	Frame Size	Part No.	Commander C200	Commander C300
<b>Feedback</b>				
SI-Encoder			82400000018100	
SI-Universal Encoder			82400000018300	
<b>Additional I/O</b>				
SI I/O			✓	✓



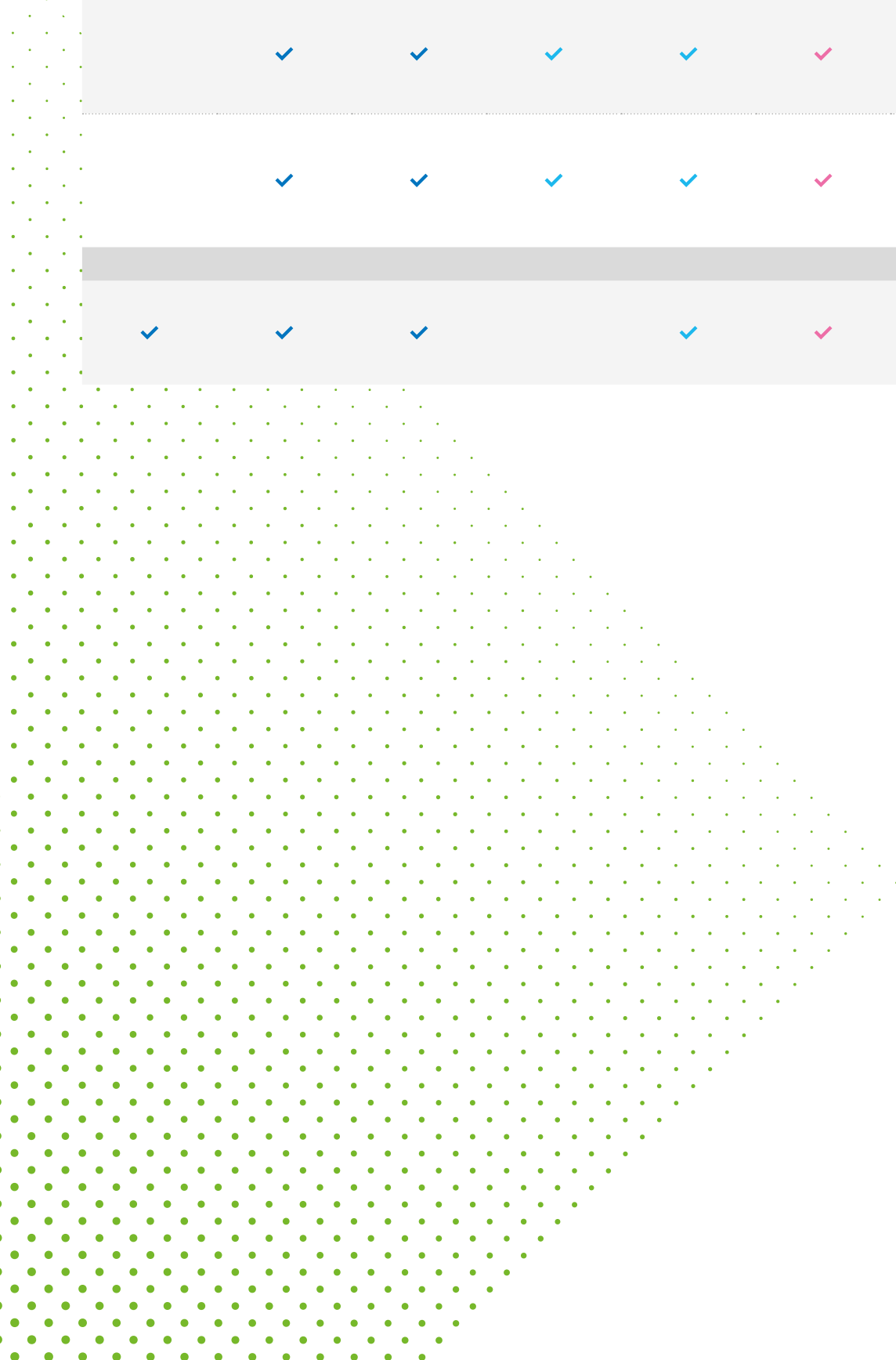

Unidrive M400	Unidrive M600	Unidrive M700	Elevator Drive E300	Pump Drive F600	Digitax HD	Digitax SF	Mentor MP
	✓	✓	✓	✓	✓		
	✓	✓	✓	✓	✓		
✓	✓	✓		✓	✓		



	Frame Size	Part No.	Commander C200	Commander C300
Input / Output (I/O) terminal block and cable assembly		2216-0211		
Input / Output: Interface Connector		3412-0050		
Surge absorber/protector		2490-2754		
		2490-0004		
Internal brake resistor	3	1220-2752		
	4 & 5	1299-0003		
DC bus paralleling kit	3	3470-0048		
	4	3470-0061		
	5	3470-0068		
	6	3470-0063		
	6 (connect to frame 3,4 & 5)	3470-0111		
Through hole IP65 kit IP65 / UL TYPE 12 rating is achieved on the rear of the drive when through panel mounted using the following kits.	3	3470-0053		
	4	3470-0056		
	5	3470-0067	✓	✓
	6	3470-0055	✓	✓
	7	3470-0079	✓	✓
Through hole IP65 kit IP55 / UL TYPE 12 rating can be achieved for frame sizes 9A and 9E using the following kits:	8	3470-0083	✓	✓
	9A	3470-0119	✓	✓
	9E & 10D	3470-0105	✓ (9E only)	✓ (9E only)
Through hole IP65 kit	10 Inverter	3470-0108		
	10 Rectifier	3470-0106		
	11E & 11T	3470-0126		
	11 D Inverter	3470-0130		
Through-hole IP55 kits	11 & 11 Rectifier	3470-0123		
	9A	3470-0119		
	9E/10E	3470-0105		
	10 Inverter	3470-0108		
	10 Rectifier	3470-0106		
	11E & 11T	3470-0126		
	11D Inverter	3470-0130		
	11 Rectifier	3470-0123		



		Frame Size	Part No.	Commander C200	Commander C300
Line reactor		9E (400 V)	7022-0063	✓	✓
		9E (200 V/400 V)	4401-0181		
		9E (575 V/600 V)	4401-0183		
		10 (200 V/400 V)	4401-0182		
		10 (575 V/600 V)	4401-0184		
		11 (400 V)	4401-0259		
		11 (575 V/600 V)	4401-0261		
Finger Guard Grommet		9A / 9E	3470-0107	✓	✓
		9 & 10	3470-0107		
Lifting Tool		8 & 9A	3470-0107		
		9A	7778-0045	✓	✓
		9E	7778-0016	✓	✓
		9E, 10 & 11	7778-0016		
Fan Replacement Kit		1	3470-0092	✓	✓
		2	3470-0095	✓	✓
		3	3470-0099	✓	✓
		4	3470-0103	✓	✓
		1 & 2	9500-1053		
Cable grommet kit		3	9500-1054		
		7	3470-0086		
		8 - Single cable	3470-0089		
		8 - Dual cable	3470-0090		
Tile mount kit		9A, 9E, 10* & 11* (*M600/M700 only)	3470-0107		
		3	3470-0049		
		4	3470-0060		
General kit items		5	3470-0073		
		Keypad blanking cover (10 pieces in pack)	3470-0058		
		Frame size 3 & 4 power connector split kit	3470-0064		
Optional external EMC filters	All	I/O commissioning extender adaptor	3000-0009	✓	✓



	Frame Size	Part No.	Commander C200	Commander C300
	All	4200-1001	✓	✓
	100 V	2	4200-2000	✓
	200 V	4200-2001	✓	✓
		4200-2002	✓	✓
		4200-2003	✓	✓
		4200-2004	✓	✓
	400 V	4200-2005	✓	✓
		4200-2006	✓	✓
	200 V	3	4200-3000	✓
		4200-3001	✓	✓
		4200-3004	✓	✓
		4200-3005	✓	✓
	400 V	4200-3008	✓	✓
		4200-3009	✓	✓
	200 V	3	4200-3230	
	400 V	4200-3480		
	200 V	4	4200-4000	✓
		4200-4001	✓	✓
		4200-4002	✓	✓
		4200-4003	✓	✓
	400 V	4200-4004	✓	✓
		4200-4005	✓	✓
	200 V	4	4200-0272	
	400 V	4200-0252		
	200 V	5	4200-0312	✓
	400 V	4200-0402	✓	✓
	200 V	4200-0122		
	400 V	6	4200-2300	✓
	200 V & 400 V	4200-4800	✓	✓
	575 V & 690 V	4200-3690		
	200 V & 400 V	7	4200-1132	✓
	575 V & 690 V	4200-0672		
	200 V & 400 V	8	4200-1972	✓
	575 V & 690 V	4200-1662		
	200 V & 400 V	9A	4200-3021	✓
	575 V & 690 V	4200-1660		
	200 V & 400 V	9E & 10	4200-4460	
	575 V & 690 V	4200-2210		
		11	4200-0400	
		4200-0690		

Unidrive M built-in EMC filter complies with EN 61800-3. External EMC filters are required for compliance with EN 61000-6-4.























Frame 12 Kits and Accessories ordering information	Frame Size	Part No.	Commander C200	Commander C300
Input wiring kit		6772-0006		
Output wiring kit		6772-0007		
Earthing kit		6772-0008		
Cubicle fitting kit		6772-0009		
		6772-0010		
Pallet truck lifting kit and ramp		6500-0150		
Fixed ramp		6500-0151		
		6500-0158		
Pallet truck lifting and ramp		6500-0159		
External EMC filter (All 3 models)		FN 3311-1000-99-C16-R55		
		Shaffner HLD 103-500/1000 Block		





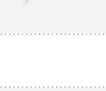



## Digitax Only













Optional Drives Programming and Operator Interface	Part No.	Digitax HD	
Multi-axis Kit (standard – without SI-Option Mounting Kit fitted)		9500-1047	✓
Multi-axis Kit (with SI-Option Mounting Kit fitted)		9500-1048	✓
External Cable Grommet Kit up to 6mm <sup>2</sup>		3470-0145	✓
Multi-axis Kit (with SI-Option Mounting Kit fitted)		9500-1050	✓
KI-Compact 485 Adaptor		8270000020300	✓
Input Line Choke		4401-0236	✓
Frame 1 Rear Ultraflow™ Vent Kit		3470-0158	✓
Frame 2/3 Rear Ultraflow™ Vent Kit		3470-0181	✓
Retrofit Kit – Epsilon 202-206		3470-0185	✓
Retrofit Kit – Epsilon 209-216		3470-0184	✓
Retrofit Kit – Digitax ST/SP0		3470-0182	✓
Retrofit Kit – M'Ax		3470-0183	✓
Drive – Mountable Brake Resistor		9500-1049	✓
Compact Brake Resistor Kit – 50 W, 70 Ω		9500-1049	✓
External Brake Resistor		1220-2201	✓
External Brake Resistor – DBR 100 W, 20 Ω		1220-2401	✓
External Brake Resistor – DBR 100 W, 40 Ω		1220-2801	✓
External Brake Resistor – DBR 100 W, 80 Ω		8270000020200	✓
Encoder Breakout Kit		9500-1055	✓
SI-Option Mounting Kit		9500-1055	✓



DC bus conn. kit - Unidrive M fr03 (panel mount)		3470-0146	✓
DC bus conn. kit - Unidrive M fr03 (through mount)		3470-0147	✓
DC bus conn. kit - Unidrive M fr06 (panel mount)		3470-0148	✓
DC bus conn. kit - Unidrive M fr06 (through mount)		3470-0149	✓

Digitax HD EMC Filters	Voltage	Model (M75X-...)	Order Code	Digitax HD
	200 V	1200022	4200-3503	✓
		1200040	4200-3503	✓
		1200065		✓
		2200090		✓
		2200120	4200-5033	✓
		3200160	4200-6034	✓
		1200022	4200-8744	✓
		1200040	4200-6002	✓
		1200065	4200-6001	✓
		2200090	4200-5833	✓
		2200120	4200-5833	✓
		3200160	4200-5833	✓
	400 V	01400015 to 01400042	4200-8744	✓
		02400060 to 02400105	4200-1644	✓
		03400135 to 03400160	4200-5833	✓
		* Multi-axis up to 46 A	4200-0033	✓
		* Multi-axis up to 60.2 A	4200-5534	✓
		* Multi-axis up to 82.2 A	4200-7534	✓
		* Multi-axis up to 109.5 A	4200-0035	✓

Digitax SF EMC Filters	Voltage	Model (M75X-...)	Order Code	Digitax SF
	Rated Voltage (V): 250 Vac		4200-0056	✓
			4200-3106	✓

## Mentor MP Only

SM Option Modules			Mentor MP
<b>Machine Control</b>			
SM-Applications Lite V2		82000000014100	✓
SM-Applications Plus		82000000014000	✓
SM-Register		82000000015000	✓
<b>Communications</b>			
SM-EtherNet		82000000013200	✓
SM-PROFINET		82000000015800	✓
SM-EtherCAT		82000000014900	✓
SM-CANopen		82000000012000	✓
SM-Profibus DP-V1		82000000011000	✓
SM-DeviceNet		82000000011100	✓
SM-Interbus		500 kBd: 82000000011600 2MBd: 82000000015200	✓
<b>Feedback</b>			
SM-Encoder Plus		82000000011700	✓
SM-Universal Encoder Plus		82000000011310	✓
SM-Encoder Output Plus		82000000013900	✓

Additional I/O			
SM-I/O 32		82000000014700	✓
SM-I/O Plus		82000000011200	✓
SM-I/O Lite		82100000012500	✓
SM-I/O Timer		82100000012600	✓
SM-I/O 120 V		82000000013300	✓
SM-PELV		82000000012900	✓

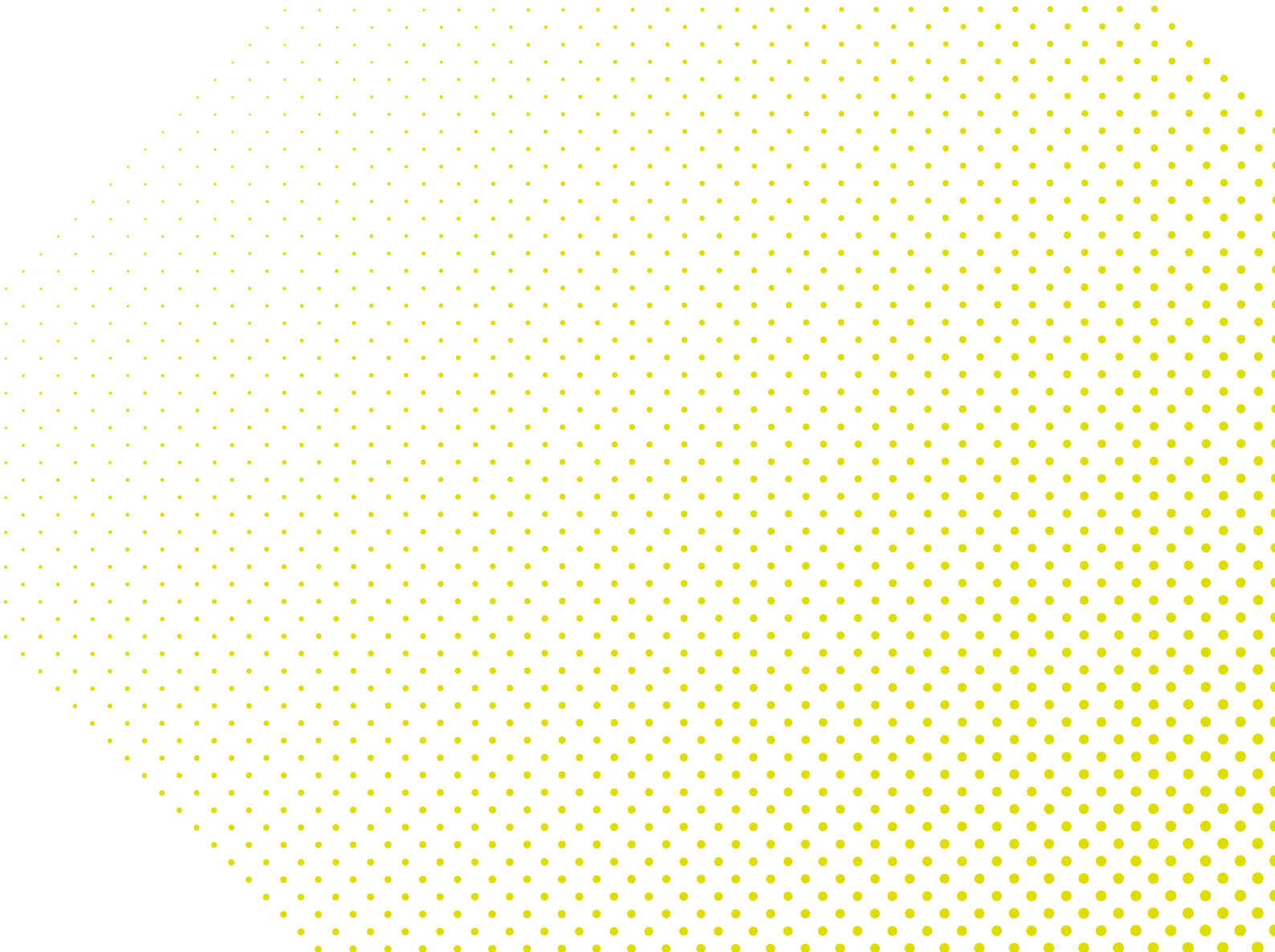





# CERTIFICATIONS

	Description
	RCM - Australia and New Zealand: RCM Marking ensures the safety and performance of telecoms, electrical, and wireless devices. By placing an RCM Mark on products and equipment, manufacturers certify that their devices meet all applicable standards required for product safety and performance.
	A CE Mark is a symbol that must be affixed to many products before they can be sold on the European market. The mark indicates that a product: Fulfills the requirements of relevant European product directives. Meets all the requirements of the relevant recognized European harmonized performance and safety standards.
	The UL Listed seal means that the product has been tested by UL to nationally recognized safety and sustainability standards. Additionally, it has been found to be free from a reasonably foreseeable risk of fire, electric shock in a Division 2 environment.
	Russian Customs Union: The Eurasian Conformity mark (EAC, Russian: Евразийское соответствие (EAC)) is a certification mark to indicate products that conform to all technical regulations of the Eurasian Customs Union.
	2 Year Warranty All products except Commander and Pump drives.
	5 Year Warranty Commander and Pump drives only.
	DNV GL is the world's leading classification society and a recognized advisor for the maritime industry. We enhance safety, quality, energy efficiency to make the maritime industry safer, smarter and greener.
	SIL is a relative level of risk reduction provided by a safety function. SIL ratings correlate to frequency and severity of hazards. They determine the performance required to maintain and achieve safety — and the probability of failure.
	A TUV certification means a sampling of the product has been tested for safety and found to meet the minimum requirements of the German Equipment and Product Safety Act.
	This is the switch standard for Canada designed to go into other low voltage (below 600V) appliances. This standard is equivalent to the CSA mark. This receive the "cUR Mark" or if combined with a USA approval, the "cURus Mark"
	The KC (Korea Certification) mark signifies compliance with Korea's product safety requirements for electrical and electronic equipment and is issued by Korea-based certification bodies that have been approved by the Korea Standards Association. Manufacturers and distributors of electronic goods may apply a KC mark to their goods once they have completed the standard procedure.
	
	

Commander		Unidrive					Digitax				Elevator	Pump	Mentor
C200	C300	M600	M700	M701	M702	M400	M750	M751	M753	Digitax SF			
•	•	•	•	•	•	•	•	•	•	•	•	•	•
•	•	•	•	•	•	•	•	•	•	•	•	•	•
•	•	•	•	•	•	•	•	•	•	•	•	•	•
•	•	•	•	•	•	•	•	•	•	•	•	•	•
		•	•	•	•	•	•	•	•	•	•		•
•	•											•	
Pending		•	•	•	•								Pending
	•	•	•	•	•	•	•	•	•			•	•
	•	•	•	•	•	•	•	•	•			•	•
										•			
•	•	•	•	•	•	•	•	•	•				•
	•	•	•	•	•	•	•	•	•			•	•
•	•	•	•	•	•	•	•	•	•	•	•	•	•

# STANDARDS

	Commander		Unidrive	
	C200	C300	M600	M700
				•
				•
			•	•
				
<b>RTMoE</b>				•



Unidrive			Digitax				Elevator	Pump	Mentor
M701	M702	M400	M750	M751	M753	Digitax SF			

	•		•					
	•		•					
•	•		•	•			•	•
					•			
	•		•					

# SERVICE & SUPPORT



Control Techniques' 94 subsidiary Drive Centers and Resellers offer customers **local technical sales, service and design expertise; many also offer a comprehensive system design and build service including local and bespoke training courses.**



### Technical Support

Our global Drive Centre and Distributor network offers local technical support. Find your local support location.

[www.controltechniques.com](http://www.controltechniques.com)



### Drive Set-up

Everything you need for quick and easy installation in our free-to-access online guides:

[www.drive-setup.com](http://www.drive-setup.com)



### Diagnostic Tool

Quickly solve any error codes that the drive may show. Download:

[controltechniques.com/mobile-applications](http://controltechniques.com/mobile-applications)



### 5 Year Warranty

Guaranteed for products listed below:

- Commander C
- Pump Drive F600

Warranty terms and conditions apply.



\*For Microsoft users, please note that this mobile app operates with Windows 10 only.



### Technical Documentation

Product support downloads including user guides, software, firmware etc.



### Services & Repairs

Our certified Service and Repair Centers have extensive product knowledge and provide a prompt, professional, guaranteed repair service.



### Drive Systems

Fully designed, built & commissioned automation systems for your drive applications.



### Training

Control Techniques Global Training Centers offer a unique program of drive, servo and software training solutions.



### Commander C Virtual Demo

The Commander C Virtual Demo Tool provides a safe and accessible first experience with Commander C variable speed drives and allows you to get familiar with the Commander C keypad and menu structure.



# TECHNICAL SUPPORT

**Whatever your technical question, we have the tools and teams to support you. Access professionally qualified engineers with many years of product knowledge and field experience.**

Support Suite is our online tool with masses of technical information that you can access whenever you need to. You can submit enquires to the Control Techniques technical support network and share enquires within your own organisation. These can be prioritised for a fast response.

It also gives you access to a vast amount of technical information and the Knowledge base Library, including product documentation, application notes, approvals and certifications, PC tools and web based diagnostics. You can receive automated e-mail updates relating to products and documentation, and Support Suite can also be configured in your local language.

Or speak to a drive obsessive. If you can't find the information online, your local Drive Centre or the Global Technical Support team are on hand to help.

We can guarantee a fast, accurate response to your enquiry in your local language and time zone.



[controltechniques.com/academy](https://www.controltechniques.com/academy)



# DRIVE SET-UP

Our drive set-up is complete with resources to assist you with rapid installation and commissioning, fast diagnostics and easy option module selection.

## How it works:

- 1 Select your Language**  
 Choose from English (Global), English (USA), Deutsch, Espanol and Italiano.
- 2 Select your Product**  
 Choose from Commander C200 & C300, Unidrive M and Digitax HD
- 3 Step by Step**  
 Get access to videos, user guides, software downloads and applications.

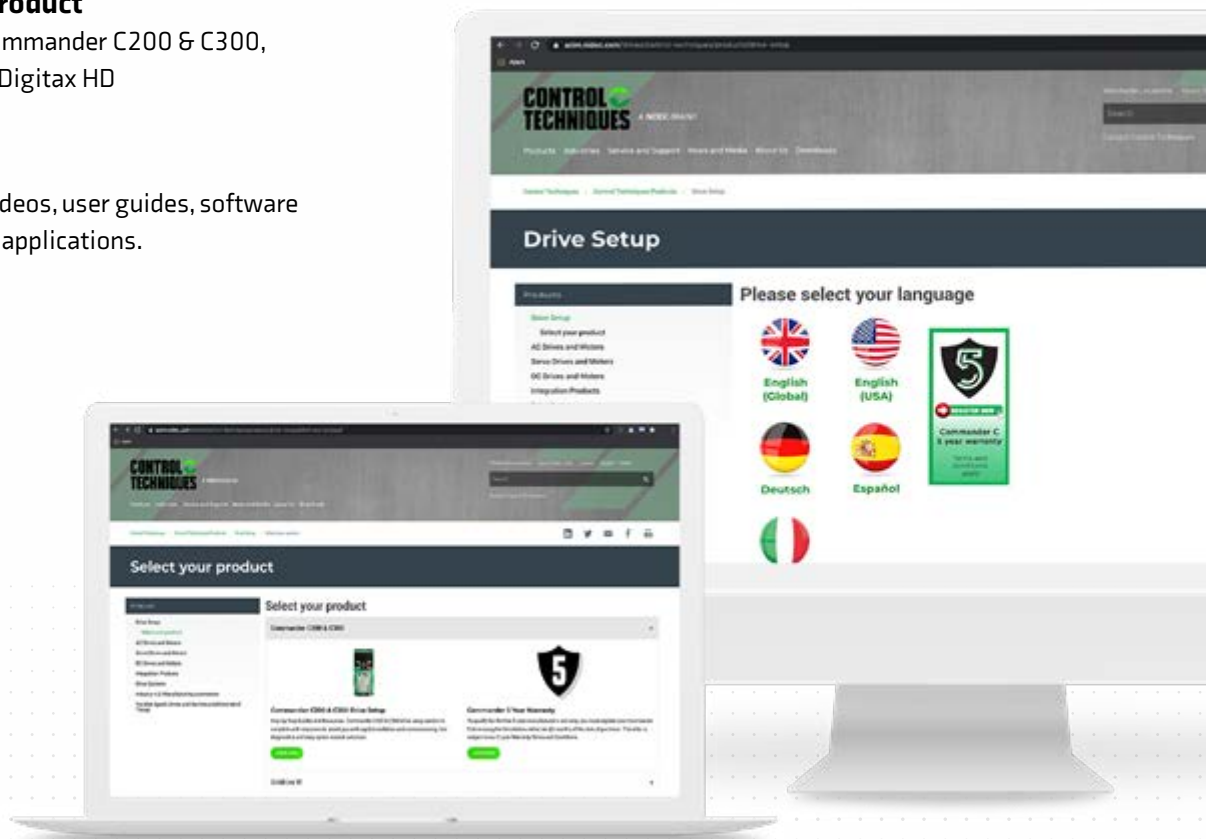



# DIAGNOSTIC TOOL

**Diagnostic Tool is a fast and simple tool, which allows users of Control Techniques' drives to quickly solve any error codes that the drive may show.**

Built within the app are easy to locate wiring diagrams for first time setup and fault finding with links to the relevant comprehensive manuals. The app also has full contact details of the technical support teams around the world to aid you with technical assistance.

**Download from the below app stores for free.**

**Microsoft:**



**Apple:**



**Google:**



**\*For Microsoft users, please note that this mobile app operates with Windows 10 only.**



# 5 YEAR WARRANTY

**Control Techniques' free 5 year warranty is another testament of our exceptional track record for reliability and durability.**

With 5 years guarantee, rest assured your application will continue to run uninterrupted, giving an unbeatable total cost of ownership.

### Commander C

Our Commander C series is built to cope with harsh environments. In fact, it is so reliable we are confident enough to supply it with a free five-year warranty.

Now you can buy with the same confidence.

### Pump Drive F600

All F600s up to 55kW can register to extend the warranty from the standard two years to five at no extra cost.

For the past 45 years we have brought new technology and innovations to the world of automation. You can buy a F600 with confidence, safe in the knowledge that your purchase comes with the security a 5 year warranty offers.



Warranty terms and conditions apply.



# DOCUMENTATION

**You may want support throughout a project, or enjoy the peace of mind knowing someone is here to help if you need it.**

Our goal is to make it easy for you tap into specialist knowledge, helping to take some of the pressure off your design team.

Learn how Control Techniques drives and motors can help your business achieve energy savings and improve operating efficiency.

## Brochures:

- Product Portfolio
- High Performance Drives
- General Purpose Drives
- Specialist Drives
- DC Drives
- Servo Drives and Motors
- Integration Products

## User Guides and Software:

- Manuals
- Software
- Firmware
- Installation Guides
- 2D Drawings
- 3D Drawings
- Technical Data



**CONTROL  
TECHNIQUES**



**COMMANDER**  
GENERAL PURPOSE, LOW VOLTAGE AC DRIVES  
**DRIVE OBSESSED**

**CONTROL  
TECHNIQUES**



**PUMP DRIVE F600**  
SIMPLE, RELIABLE FLOW CONTROL  
SPECIALIST DRIVE  
**DRIVE OBSESSED**

**CONTROL  
TECHNIQUES**

**PRODUCT  
PORTFOLIO**



**DRIVE OBSESSED**

**CONTROL  
TECHNIQUES**



**DIGITAX HD**  
MINIMUM SIZE, MAXIMUM PERFORMANCE  
**DRIVE OBSESSED**

**CONTROL  
TECHNIQUES**



**MENTOR MP**  
HIGH PERFORMANCE DC DRIVE  
**DRIVE OBSESSED**

**CONTROL  
TECHNIQUES**



**DFS SFD**  
READY TO  
High p

**000 ELEVATOR**  
DRIVES FOR CLASS-LEADING RIDE COMFORT  
**DRIVE OBSESSED**



# SERVICES & REPAIRS

**Should you ever experience a Control Techniques drive failure, minimizing the impact on your plant is our main concern. High levels of performance and reliability are a feature of our product range but, occasionally, failures do occur. When this happens, help is at hand from our certified Service and Repair Centers.**

These centers have extensive product knowledge and provide a prompt, professional, guaranteed repair service. Contact our Service and Repair Centers for any Control Techniques products, including Unidrive M, Commander, Digitax and Mentor.

## Exceptional service

- All drive repairs carry a new 1-year parts and labour warranty on the work done.
- Fast turnaround is standard and even faster turnaround is available at a reasonable extra charge. In addition, our Service Centers carry stock for our major product lines of refurbished drives. These are usually available for immediate shipping and are exchanged for your failed product.
- The drives are returned in a clean state with any damaged components replaced, including plastics and metalwork.
- Each product has a fixed repair cost regardless of the fault. This allows us to tell you immediately what our service will cost and the processing time of your order.
- On request, and where possible, the repaired drive is returned with the same parameter configuration as the failed unit to allow you to get the machine operational as quickly as possible.

## Future reliability

- All useful specification upgrades are made to repaired drives enhancing performance and installed life time operation.
- Reliability is maintained with every aspect of the drives operation being checked.
- Only Control Techniques Engineering and Development certified components are used for repairs.
- Failure data feedback to Engineering and Development enhances future reliability.

## The environment

- Waste materials are recycled to reduce any harmful impact on the environment.

## Safety

- High voltage insulation testing ensures the continuing safe operation of the drive (2kV for a 400V product).
- High current earth bond test is completed on every unit.





# DRIVE SYSTEMS

### Custom design, build and commissioning.

Through our worldwide Automation Centers we have over 30 years' experience in providing complete solutions for thousands of applications from a control system for an automatic welder through to the complete line control in a paper, timber or steel mill.

### Range of services:

- Industry leading applications engineering experience
  - In-house project design and management
  - Comprehensive software development and engineering support
  - Panel-building, installation and project commissioning
  - First class service and support
  - Worldwide network of Automation Centers for ongoing support of overseas contracts
- **Consultation and site meeting**
  - **From Concept to ePlan**
  - **Design**
  - **Software services**
  - **Communications**
  - **Trouble-free operation with other manufacturers' equipment**
  - **High-speed deterministic control**
  - **Manufacturing**
  - **Installation, commissioning & after sales support**



# TRAINING

**Control Techniques Global Training Centers offer a unique program of drive, servo and software training solutions.**

Train in a safe and dedicated environment with highly qualified and experienced trainers for a great mix of classroom and practical 'hands-on' learning experience. Most Automation Centers offer both standard and bespoke courses. To find out about training courses near you, locate your nearest Automation Center or Reseller.

## UK and Worldwide Training

For UK training enquiries please contact the Control Techniques Academy:

**Tel: 01686 612900**

**Fax: 01686 612999**

**Email: [controltechniques.academy@mail.nidec.com](mailto:controltechniques.academy@mail.nidec.com)**

## Training Flyers:

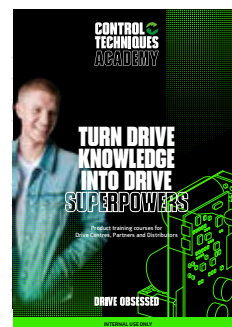
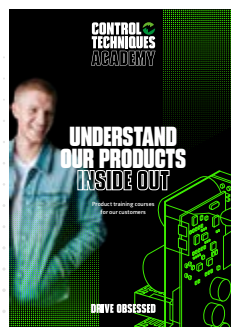
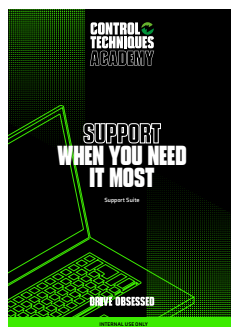
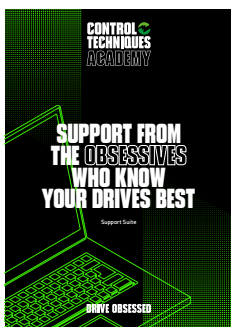



# VIRTUAL DEMO

**The Commander C Virtual Demo Tool provides a safe and accessible first experience with Commander C variable speed drives and allows you to get familiar with the Commander C keypad and menu structure.**

This digital replica of a Commander C drive, motor and control allows you to use the virtual keypad to set-up the drive parameters for commissioning just like in a real situation. Once the key parameters have been set, the drive can be enabled and the motor shaft will spin.

To see just how easy it is to set-up the drive, visit: [virtualdemo.controltechniques.com](http://virtualdemo.controltechniques.com)



Scan here to see how the drive is set up

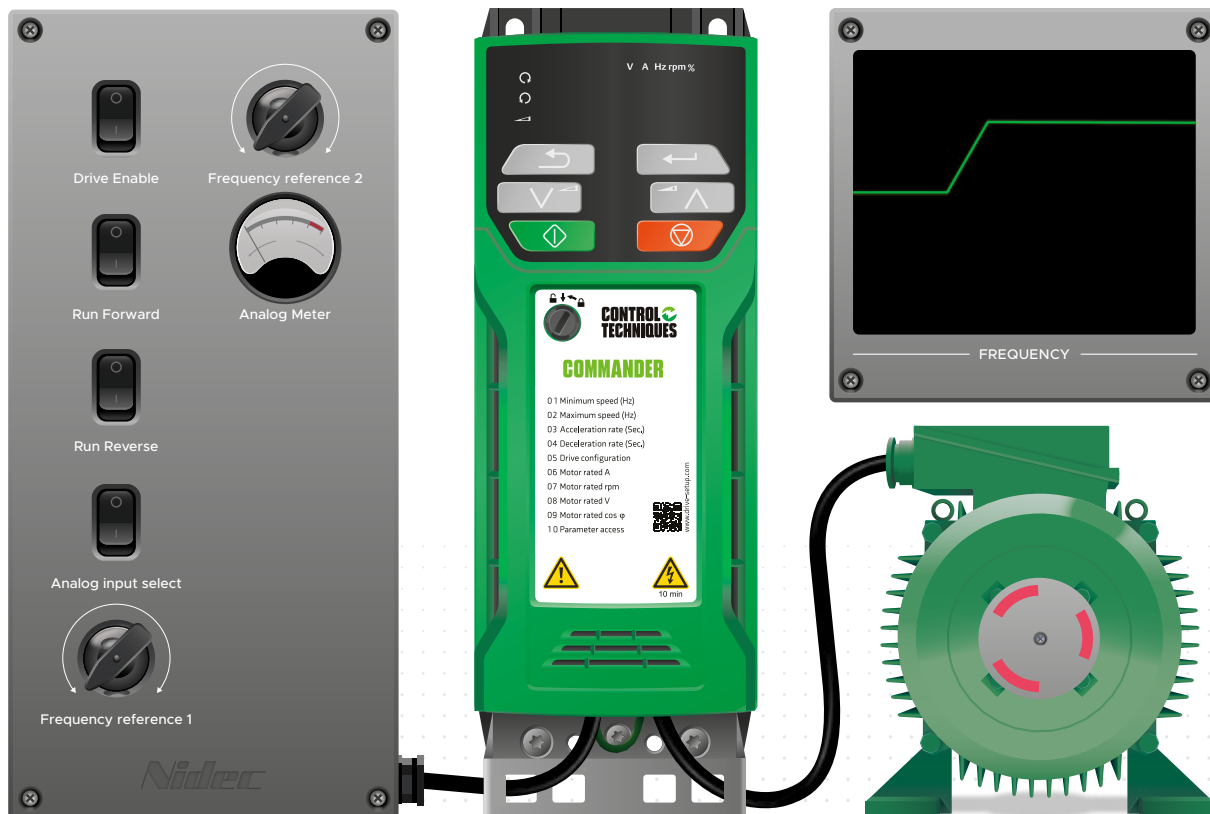



# DRIVE CENTRES



## Australia

**Nidec Industrial Automation Australia Pty Ltd**  
ABN 12 003 815 281, 16 - 18 Tucks Road, Seven Hills NSW 2147



## Belgium

**Nidec Industrial Automation Belgium NV**  
Blarenberglaan A23/bus 1, Industriepark Noord, Mechelen 2800



## Canada

**Control Techniques & KB Electronics Canada - a division of Nidec Industrial Automation**  
Canadian Sales Office, Unit 1, 752 Cochrane Drive, Markham, ON L3R 8E1



## China

**Control Techniques, Leroy Somer Electro - Technique (Fuzhou) Co., Ltd. Beijing Branch**  
F15 Gateway Building, Room 1506, No.10Yabao Road, Chaoyang District, Beijing 100020



## Czech Republic

**Control Techniques Brno s.r.o.**  
Podnikatelska 2b, CZ 61200, Brno



## Germany (including Austria)

**Control Techniques GmbH**  
Meysstrasse 20, Hennef D-53773



## India

**Control Techniques India Private Limited**  
117B Developed Plot Industrial Estate, Perungudi, Chennai, Tamilnadu 600 096



## Italy

**Nidec Industrial Automation Italy SpA**  
Via Idiomi 3/6, Assago, MI 20090



## Korea

**Nidec Korea Corporation - Seongnam Sales Office**  
Room 1101, 11th Floor, Sicox Tower - (Sangdaewon-dong), 484, Dunchon-daero, Jungwon-gu, Seongnam 13229



## Malaysia

**Nidec Precision Malaysia Sdn Bhd**  
C/O Control Techniques - Leroy Somer, 11.08, Amcorp Tower 18, Persiaran Barat, 46050 Petaling Jaya, Selangor 46050



## Netherlands

**Nidec Netherlands B.V.**  
Kubus 155, 3364 DG, Sliedrecht



**Philippines**

**Nidec Motor Philippines Corporation**  
 9F North Tower Rockwell Business Center  
 Sheridan, Sheridan Corner United Street,  
 Mandaluyong City 1550



**Poland**

**Nidec Industrial Automation Poland**  
 ul. Baltycka 6, Poznań, 61-014



**Romania**

**Nidec Oradea**  
 20 Petre P. Carp Street, Oradea 410605



**Singapore**

**Control Techniques Singapore Pte Ltd**  
 36 Lok Yang Way 628641



**South Africa**

**Nidec Industrial Automation Southern Africa (Pty) Ltd**  
 Stand 331& 333, Corner Olympic Duel and Angus  
 Crescent, Northlands Business Park, Newmarket  
 Street, Northriding, Johannesburg 2162



**Spain**

**Nidec Industrial Automation Iberia, S.A. (Barcelona AC)**  
 Pol Ind Pedrosa, Carrer Primer de Maig, 41,  
 Entrada Almacen por C/Rafael Barradas 1  
 L'Hospitalet de Llobregat, Barcelona 8908



**Switzerland**

**Control Techniques AG**  
 Lindächerstrasse 1, Birmenstorf CH-5413



**Taiwan**

**Nidec Taiwan Corporation**  
 Room 1001, 10F, No 88, Sec 2, ZhongXiao E. Rd,  
 Taipei 10050



**Thailand**

**Nidec (Thailand) Co Ltd**  
 200 Moo 4, Jasmine International Tower, 26th  
 Floor, Unit 2601, Chaengwatana Road, Pakkred,  
 Nonthaburi 11120



**Turkey**

**Control Techniques A.Ş.**  
 İçerenköy Mah. Topçu İbrahim Sk. No:13 K:2  
 34752, Ataşehir, Istanbul



**United Kingdom**

**Nidec Industrial Automation UK Ltd**  
 Stafford Park 4, Telford TF3 3BA



**USA**

**Control Techniques - a Nidec Motor Corporation business**  
 Americas Headquarters, 7078 Shady Oak Road,  
 Eden Prairie, MN 55344

# FAQS





# GENERAL

Question	Answer
<b>What are Electric Drives?</b>	<p>"In the Industrial and Commercial sectors, electric drives are devices that are connected to fixed electrical supply systems and provide variable electric power supplies for electric motor control.</p> <p>Different electric drives are available to control different electric motor types such as DC motors, AC induction motors and AC permanent motors. Some electric drives can be applied to more than one type of motor."</p>
<b>What are VFD Packaged Solutions?</b>	<p>"Packaged drive solutions are electric drives mounted in industrial enclosures and are typically high power and available with a range of power and control accessories including HMIs, line reactors, fuse protection and cooling systems.</p> <p>These large packaged AC drives are typically pre-engineered and configurable and provide robust and reliable solutions for motor control applications."</p>
<b>What is a VFD?</b>	<p>"A variable frequency drive or VFD is an electronic controller used to vary the frequency applied to an AC motor in order to control the motor speed. Other names for such devices include variable speed drive or VSD, adjustable speed drive or ASD and inverter.</p> <p>VFDs are commonly used in automation systems and for machine control and productivity and in building automation systems for energy savings."</p>
<b>What is an AC Drive?</b>	<p>"An AC Drive is a device that is used to control the speed of an AC motor. AC drives range from variable frequency drives for basic speed control to closed loop vector drives for precision speed and torque control.</p> <p>AC drives are available with a wide range of control, feedback and networking options. Working with a trusted drive specialist is the best way to select the optimum drive for your application."</p>
<b>What is Motor Control?</b>	<p>"Motor control refers to devices that are used to control the torque, speed or position of an electric motor. Examples of electronic motor controls are soft starters that limit the electrical and mechanical shock applied to a system when an AC motor is started and VFDs and servo drives that control motor speed and position across the working design range of the motor.</p> <p>It is important that the motor and motor controls are matched for long term reliable operation."</p>
<b>What is a DC Drive?</b>	<p>"A DC drive is an electronic controller used to vary the voltage and current applied to a DC motor in order to control the motor speed and torque. Other names for such devices include variable speed drive or VSD, adjustable speed drive or ASD.</p> <p>DC Drives are not commonly used in modern automation systems today but can be found in older machines."</p>
<b>What is a motion controller?</b>	<p>"The term motion control is commonly used to describe machinery where the position of the machine parts are controlled. Motion controllers can be in the form of standalone electronic hardware devices or embedded in PLCs (Programmable Logic Controllers), PCs or drives.</p> <p>Servo drives and motors are most commonly used in these applications but AC drives and motors can also be used depending on the machine type."</p>
<b>What is a servo drive?</b>	<p>A servo drive is an electronic controller used to precisely control the torque, speed and position of a servo motor or actuator in motion control applications. The term servo amplifiers is also used. Most servo drive systems include motor feedback devices that the servo drive uses to continuously vary its output to meet the machine demands.</p>
<b>What is a servo motor?</b>	<p>A servo motor is a type of permanent magnet motor used most commonly in motion control positioning applications. Compared to standard AC induction motors servo motors are typically smaller and lighter and can be controlled for highly dynamic and high precision applications. Most servo motors are supplied with a feedback device for closed loop speed and position control systems.</p>

# COMMANDER C

Question	Answer
<b>General Topics</b>	
How do I clear the Digital Output Overload (O.Ld1) fault on my Commander C200/C300 drive?	Reduce the total load on digital output (DO) and the 24VDC terminal rail to below 100 mA. Check for incorrect wiring and damages or re evaluated the loads that are supported from the digital outputs.
How can I change the direction of my motor running in open loop from a drive?	<p>"To change the direction of the motor by phase output (where you want to change the positive direction of the motor), with the drive powered down do either:</p> <ol style="list-style-type: none"> <li>1. Swap the installation location of 2 of the motor leads at the drive output terminal.</li> <li>2. Set Pr. 5.042 to ""On"" to reverse the output phase sequence.</li> </ol> <p>To change the direction of the motor where you want the drive to run in the opposite direction (reversing) on command, you can do any of the following:</p> <ol style="list-style-type: none"> <li>1. Change the digital input destination that is running the drive from ""Run Forward (Pr 6.030)"" to ""Run Reverse (Pr 6.032)"".</li> <li>2. If controlling from a fieldbus with the control word, use Bit 3 instead of Bit 1 to issue the run command." </li></ol>
What is a PH.LO trip on my drive? How can I check what is causing it?	<p>"The Ph.Lo fault is an indication of an input phase loss or large supply imbalance.</p> <p>Check phase to phase, phase to ground and do the same on the output side to see if one or more phases are dipping right before the drive trips compared to the other two legs. Also, measure the DC Bus Link (between: DC+ and DC- when meter is set for an AC mode) to confirm if there is a significant ripple input/output voltage imbalance."</p>
What are the best ways to troubleshoot an OV trip on a Commander drive, and what does this mean?	<p>DC bus voltage has exceeded the peak level or maximum continuous level for 15 seconds. The OV trip indicates that the DC bus voltage has exceeded the maximum limit. Possible solutions:</p> <p>Increase Deceleration Rate (Pr 04)</p> <p>Decrease the braking resistor value (staying above the minimum value)</p> <p>Check nominal AC supply level</p> <p>Check for supply disturbances which could cause the DC bus to rise</p> <p>Check motor insulation using insulation tester</p>
What are the best ways to troubleshoot an OIAC trip on a Commander drive, and what does this mean?	<p>Instances output over current detected.</p> <p>The instantaneous drive output current has exceeded the set limit. Possible solutions:</p> <p>Increase acceleration/deceleration rate</p> <p>If seen during autotune reduce the voltage boost</p> <p>Check for short circuit on the output cabling</p> <p>Check integrity of the motor insulation using an insulation tester</p> <p>Reduce the values in the current loop gain parameters.</p>
How do I use the AI-Backup adapter with an SD card to transfer parameter sets between Commander drives?	<p>NV Media Card Operation</p> <p><b>Installing the AI-Backup Adaptor (SD Card):</b></p> <ol style="list-style-type: none"> <li>1. Identify the two plastic fingers on the underside of the AI-Backup adaptor (1) - then insert the two fingers into corresponding slots in the spring-loaded sliding cover on the top of the drive.</li> <li>2. Hold the adaptor firmly and push the spring-loaded protective cover towards the back of the drive to expose the connector block (2) below.</li> </ol> <p>Press the adaptor downwards (3) until the adaptor connector locates into the drive connection below.</p> <p><b>Basic NV Media Card Operation:</b></p> <p>The whole card may be protected from writing or erasing the setting that read-only flag, refer to the Control User Guide for further information. The card should not be removed during data transfer, as the drive will produce a trip. If this occurs then either the transfer should be reattempted or in the case of a card to drive transfer, default parameters should be loaded.</p> <p><b>Note:</b> The drive supports SD cards formatted with the FAT32 file system only.</p>

<p>How do I remove the drive terminal cover from a C200/C300?</p>	<p>Using a flat bladed screwdriver, turn the terminal cover locking anti-clockwise by approximately 30 degrees, and then pull the cover off, starting on the top edge.</p> <ol style="list-style-type: none"> <li>1. Using a flat bladed screwdriver, turn the terminal cover locking clip anti-clockwise by approximately 30°.</li> <li>2. Slide the terminal cover down.</li> <li>3. Remove terminal cover in direction shown.</li> </ol>
<p>What is an "r5" trip, and how do I clear it?</p>	<p>This typically means that resistance in the motor stator is likely more than recommended for this drive. This can be solved by using a more suitable motor, or by changing the drive into "Fixed" mode by setting Pr.0.041 to "FD" and 0.042 to 1.0 .</p>
<p>How do I clear the "INH" or "INHIBIT" message on my Commander keypad?</p>	<p>Make sure the Drive enable terminal ( T11 ) on C200 (or M100-M200) or the Safe Torque OFF inputs on the C300 (M300-M400) drive are energized with a 24VDC supply from T9 or T17, or an external 24VDC supply that shares a same common reference with the drive IO.</p>
<p>How do I configure S Ramps in my Unidrive M or Commander C drive to control jerk and acceleration?</p>	<p><a href="https://youtu.be/A6sGH5GPMp8">https://youtu.be/A6sGH5GPMp8</a></p>
<p>How do I configure the Unidrive M or Commander C relay contacts?</p>	<p><a href="https://youtu.be/n2r3bBZpePQ">https://youtu.be/n2r3bBZpePQ</a></p>
<p>How do I configure the onboard PID controller in Menu 14 of my drive?</p>	<p><a href="https://youtu.be/2N-rNWNrU_U">https://youtu.be/2N-rNWNrU_U</a></p>
<p><b>Using the Drive Keypad</b></p>	
<p>What do I do if my remote keypad is stuck displaying "Initializing"?</p>	<p>"For a remote keypad to work, first the serial port communication parameters must be modified so that the remote keypad can access the drive parameters. This can be done by a drive mounted keypad or through Connect software. Make the following parameter changes, and then save them to the drive:</p> <ol style="list-style-type: none"> <li>1. Pr. 11.023 (Serial Address) = 1</li> <li>2. Pr. 11.024 (Serial Mode) = "8 1 NP M" or (5)</li> <li>3. Pr. 11.025 (Baud Rate) = "115200" or (10)</li> <li>4. Pr. 11.020 (Reset Comms)"</li> </ol>
<p>How do I change the status parameter on the drive keypad that displays during normal operation?</p>	<p>"Use the status mode parameters 11.018 and 11.019 to setup a display readout by changing their value pointers. For example, if you want to have the drive keypad to display RPM speed value, then you will set Pr. 11.018 to 5.004, then SAVE parameters. "</p>
<p>How do I save my parameter set to my drive from the keypad?</p>	<p>Saving Parameters</p> <p>When changing a parameter in Menu 0, the new value is saved when pressing the Enter button to return to parameter mode from parameter edit mode.</p> <p>If parameters have been changed in the advanced menus, then the change will not be saved automatically. A save function must be carried out.</p> <p>Procedure</p> <ol style="list-style-type: none"> <li>1. Select 'Save' in Pr 00 or Pr mm.000 (alternatival enter a value 1001 in Pr 00 or Pr mm.000).</li> <li>2. Either:</li> </ol> <p>Press the red reset button.</p> <p>Carry out a drive reset through serial communications by setting Pr 10.038 to 100.</p>
<p>How can I setup my C300 defaults the match the defaults of my old M300 from the keypad?</p>	<p><a href="https://youtu.be/lq3u-i7GdT8">https://youtu.be/lq3u-i7GdT8</a></p>
<p>How do I migrate from an M300 to a C300 using an SD card?</p>	<p><a href="https://youtu.be/YZc0n0vMB6c">https://youtu.be/YZc0n0vMB6c</a></p>

Quick Start

I just received my first Unidrive M400, how do I get it running with my motor?

<https://youtu.be/jRVi20bQ90k>

I just received my first Unidrive M300, how do I get it running with my motor?

<https://youtu.be/rEqjvG48EY>

I just received my first Unidrive M200, how do I get it running with my motor?

<https://youtu.be/ZKhVcH9hN7E>

How do I configure the digital IO on my Unidrive M or Commander C drive?

<https://youtu.be/d90jecE2zYw>

I just received my first C200, how do I get it running with my motor?

<https://youtu.be/QzQacmfRQJI>  
<https://youtu.be/BEi29-lLzu8>

I just received my first C300, how do I get it running with my motor?

<https://youtu.be/mnZo15UksCo>  
<https://youtu.be/laQTufDIUPc>

Drive Software

How can I transition my M300 drive to a C300 drive using Connect software?

<https://youtu.be/8A-8LfbNKY0>

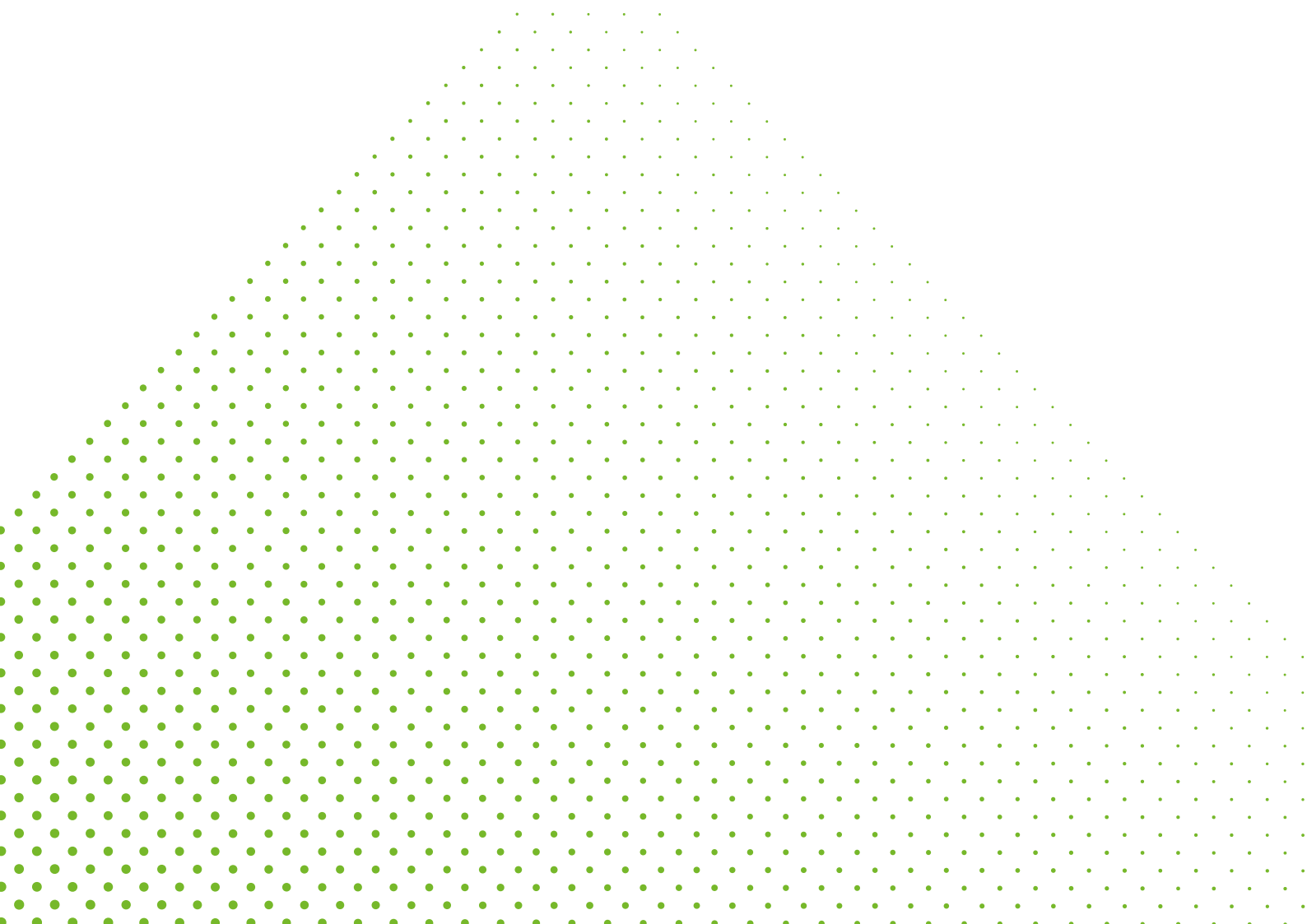

# UNIDRIVE M700

## Question

## Answer

### General Topics

How do I use the buttons on a KI Keypad, and what are the symbols that appear on the display?

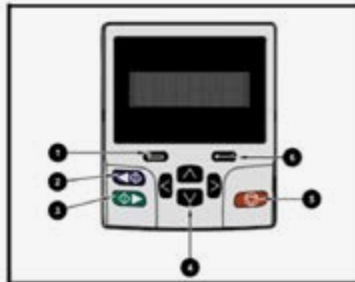

1. Escape button
  2. Start reverse (Auxiliary button)
  3. Start forward
  4. Navigation keys (x4)
  5. Stop/Reset (red) button
  6. Enter Button
- NOTE:** The red stop button is also used to reset the drive.

What kind of torque performance can I expect from my Unidrive M700 in Open Loop mode?

#### Open loop mode

The drive applies power to the motor frequencies varied by the user. The motor speed is a result of the output frequency of the drive and slip due to the mechanical load. The drive can improve the speed control of the motor by applying the slip compensation. The performance at low speed depends on whether V/F mode or open loop vector mode is selected.

#### Open loop vector mode

The voltage applied to the motor is directly proportional to the frequency except at low speed where the drive uses motor parameters to apply the correct voltage to keep the flux constant under varying load conditions.

#### Fixed V/F mode

The voltage applied to the motor is directly proportional to the frequency except at low speed where the voltage boost is provided which is set by the user. This mode can be used for multi-motor applications.

Typically 100% torque is available down to 4 Hz for a 1 Hz motor.

#### Quadratic V/F mode

The voltage applied to the motor is directly proportional to the square of the frequency except at low speed where the voltage boost is provided which is set by the user. The mode can be used for running fan or pump applications with quadratic load characteristics or for multi-motor applications. This mode is not suitable for applications requiring a high starting torque.

Is it possible to program or setup a drive parameter file without line voltage on the drive?

Yes, you can apply a 24 VDC power to the drive to power the drive processor (please see user manual for the specific drive). This will allow you to save parameters and files from the drive in the event of a power stage failure, or so that the drive can be programmed before it is installed in the equipment panel.

What is the difference between RFC-A and RFC-S mode on my Unidrive M700?

"RFC-A mode stands for "Rotor Flux Control Asynchronous" mode, and is used to control AC induction motors. Using RFC-A mode in "sensorless" control means that the drive is reading the rotor speed from the EMF on the rotor itself to do closed loop control. Using RFC-A mode in "closed loop" or "vector control" typically means that the the drive is using a physical speed feedback device to perform closed loop control.  
 RFC-S mode stands for "Rotor Flux Control Synchronous" mode, and is used to control AC servo motors with permanent magnet rotors (power factor of "1"). Using RFC-S mode in "sensorless" control means that the drive is reading the rotor speed from the EMF on the magnets on the rotor itself to do closed loop control. Using RFC-S mode in "closed loop" means that the drive is using a physical speed feedback device to perform closed loop control, along with hall sensors to determine proper commutation."

How do I troubleshoot at Over Voltage (OV) trip on my Unidrive M?

"This trip is generated when the DC Bus Voltage level rises above a set level. Generally, this trip occurs when a "overhauling load", or high-inertia condition exists during deceleration. In basic terms, the motor is converting mechanical energy into electricity, or acting like a generator. This energy must have somewhere to go, which is usually back into the drives DC Bus circuit.  
 There are several ways to prevent this depending on the severity of the mechanical load on the motor, (adjusting Regeneration Current limit, dynamic braking resistor or using a regenerative drive or add-on module). General troubleshooting steps:  
 Parameter 2.004 is set to "Standard" without a DBR.  
 Parameter 2.004 is set to "Fast" if a DBR is being used.  
 Increasing the Deceleration rate in Parameter 2.021  
 Tuning the current gains in Parameters 4.013 & 4.014 to higher values (i.e. doubled from the autotune)  
 Checking the DBR parameter settings  
 Determine if DBR is sized properly"

I am getting a "Brake R Too Hot" trip on my drive, but I am not using a braking resistor. How do I clear this trip?

If you do not have a brake resistor physically wired to the drive set Pr. 10.030, Pr. 10.031 and Pr. 10.061 all to "0". This will disable the braking resistor thermal modelling which in turn will disable the Brake R Too Hot trip.

**Quick Start**

How do I default my Unidrive M700 back to it's factory parameter defaults?

Restoring parameter defaults  
 Restoring parameter defaults by this method saves the default values in the drives memory. User security status (00.049) and User security code (00.034) are not affected by this procedure).  
 Procedure  
 1. Ensure the drive is not enabled, i.e. terminal 31 is open or Pr 06.015 is OFF (0)  
 2. Select 'Reset 50 Hz Defs' or 'Reset 60 Hz Defs' in Pr mm.000. (alternatively, enter 1233 (50 Hz settings) or 1244 (60 Hz settings) in Pr mm.000).  
 3. Either:  
 Press the red reset button  
 Toggle the reset digital input  
 Carry out a drive reset through communications interface by setting Pr 10.038 to 100.

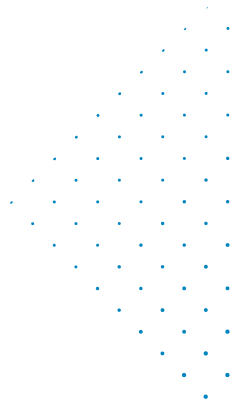

**How do I change the operating mode on my Unidrive M700?**

Changing the operating mode returns all parameters to their default value, including the motor parameters. User security status (00.049) and User Security code (00.034) are not affected by this procedure.

**Procedure**

1. Use the following procedure only if the drive is not enabled. i.e. terminal 31 is open or Pr 06.015 is OFF (0)
2. Enter either the following values in Pr mm.000, as appropriate: 1253 (50 Hz AC supply frequency) or 1254 (60 Hz AC supply frequency)
3. Change the setting Pr 00.048.

**4. Either:**

Press the red reset button

Toggle the reset digital input

Carry out a drive reset through the communications interface by setting Pr 10.0378 to 100.

**NOTE:** Entering 1253 or 1254 in Pr mm.000 will only load defaults if the setting or Pr 00.048 has been changed.

**Communications**

**What is the difference between a Unidrive M700 and an M701?**

On a Unidrive M700, the communication ports below the keypad are Ethernet communication ports, supporting Modbus TCP and Ethernet IO. On a Unidrive M701, the communication ports below the keypad are RS485 serial communication ports, supporting Modbus RTU.



# DIGITAX HD

Question	Answer
<b>General Topics</b>	
Where can I find Add On Instructions (AOI's) for PLC Controlled Motion for Digitax HD for my PLC?	All of these can be found at our website at the following link: PLC Controlled Motion Downloads: <a href="https://acim.nidec.com/en-us/drives/control-techniques/products/integration-products/plc-controlled-motion">https://acim.nidec.com/en-us/drives/control-techniques/products/integration-products/plc-controlled-motion</a>
What is the difference between a Digitax HD and a Unidrive M750, M751, and M753?	The Digitax HD is the newest and highest performing servo drive that Control Techniques has to offer. It is offered in 3 derivatives, noted by the M750, M751, and M753. The M751 offers onboard serial communications (RS485). The M750 offers onboard Ethernet communications (TCP, Modbus TCP, and Ethernet IP). The M753 offers onboard EtherCAT communications. All of these derivatives of the Digitax HD offer 2 option module slots for additional SI Option Modules.
<b>Drive Configuration</b>	
What baud rate should I set in Menu 3 when I am using the "Single Cable Solution" for my servo motor wired to the drive?	Set 3.037 = 4M Baud if feedback is wired to feedback position P1. Set 3.137 = 4M Baud if feedback is wired to feedback position P2. This setting would apply to both M700 and Digitax HD drives with encoder feedback.
<b>Using the Drive Keypad</b>	
How do I use and install the KI Compact Display and the KI Compact 485 Adapter on my Digitax HD?	<a href="https://youtu.be/yXKY0ZVWHhY">https://youtu.be/yXKY0ZVWHhY</a>
<b>Hardware Installation</b>	
How do I install SI Option modules on my Digitax HD using the SI-Option Mounting Kit?	<a href="https://youtu.be/L5ReY_khbhQ">https://youtu.be/L5ReY_khbhQ</a>
How do I connect a paralleled DC system using the multi-axis kit with the Digitax HD drive?	<a href="https://youtu.be/SgfyCuWdC88">https://youtu.be/SgfyCuWdC88</a>
How do I connect my Digitax HD drive in a DC paralleling installation?	<a href="https://youtu.be/AcaijhMkNXc">https://youtu.be/AcaijhMkNXc</a>
How do I fit the onboard compact braking resistor to my Digitax HD drive?	<a href="https://youtu.be/1tsCFw_jgDw">https://youtu.be/1tsCFw_jgDw</a>



# MENTOR MP

Question	Answer
<b>General Topics</b>	
Does the Mentor MP drives have jumpers, tachogenerator pots, and PCB switches that need manual configuration, same as the Mentor II?	No, these settings for the Mentor MP are setup using the keypad or CTSoft configuration software as setup parameters.
Our production line has some of your Mentor II drives that talk to each other using CTNet, do you still support this with the Mentor MP drives?	Yes, our drives can still be integrated on the CTNet interface using the SM-Application Plus option module with the Mentor MP. This includes the capability to host different generations of CT products on the same CTNet network, where a customer would like to have both Mentor II and Mentor MP on the same drive network.
We have a damaged Mentor II drive that has the MD29 programmed applications board, what is available for updating the MD29 when we replace the Mentor II with a Mentor MP drive?	<p>The MD29 has been replaced by the SM-Applications option module in the Mentor MP. The SM-Application module supports programming in ladder, function blocks and the DPL (text based Drive Programming Language). We can provide field services from CT to assist with the upgrade from the MD29 to an SM-Applications Module.</p> <p>SM Applications Product Page  <a href="https://acim.nidec.com/en-us/drives/control-techniques/products/options-and-accessories/intelligence-option-modules/sm-applications-plus">https://acim.nidec.com/en-us/drives/control-techniques/products/options-and-accessories/intelligence-option-modules/sm-applications-plus</a></p> <p>Field Service Request  <a href="https://acim.nidec.com/en-us/drives/control-techniques/service-and-support/field-service">https://acim.nidec.com/en-us/drives/control-techniques/service-and-support/field-service</a></p>
We have the FXM5, Field Control Units which we would like to replace, do you still stock these?	<p>We have a "drop-in" replacement which is the FXMP25 Field Controller. It can be installed using the same mounting holes as the FXM5 and supports our CTSoft configuration and parameter software.</p> <p>FXMP25 Field Controller Product Page  <a href="https://acim.nidec.com/en-us/drives/control-techniques/products/dc-drives/fxmp25">https://acim.nidec.com/en-us/drives/control-techniques/products/dc-drives/fxmp25</a></p>
Our Mentor II drives communicated with an HMI using a serial cable, we know this is becoming obsolete, do you have a recommendation for upgrading and what protocols do you have available?	<p>The Mentor II provides a RS422 connection, which is a legacy serial protocol for Control Techniques.</p> <p>The Mentor MP drives have a built in RS485 port but additional option modules can be added. The MP has a total of three slots for option modules. The most popular communication protocols that can be used with the Mentor MP by attaching an SM option module are EtherNet/IP, EtherCat, Modbus TCP/IP and DeviceNet.</p>
I have a Mentor II drive and need spares or parts. Can I still get these?	<p>The Mentor II drives were discontinued but we do have a retrofit replacement which is the "Mentor MP / Quantum MP" drive. We offer them in Regenerative and Non-Regenerative configurations.</p> <p>Control Techniques Current Products - DC Drives  <a href="https://acim.nidec.com/en-us/drives/control-techniques/products/dc-drives">https://acim.nidec.com/en-us/drives/control-techniques/products/dc-drives</a></p> <p>Our Quantum MP drives are Mentor MP drives configured with a DC contactor, input and output fusing and a dynamic braking contactor up to the 400A model.</p>
<b>General Topics</b>	
Do your Mentor MP drives have embedded PLC capabilities?	<p>Yes, the drives have a built-in programmable controller that has ladder logic. It is configured using SyPTLite which is complimentary to use software.</p> <p>Mentor MP Documentation  <a href="https://controltechniquesfaqhelp.zendesk.com/hc/en-us/articles/360047541293">https://controltechniquesfaqhelp.zendesk.com/hc/en-us/articles/360047541293</a></p>

<p>How do I transfer the parameters from one Mentor MP to another?</p>	<p>You can use the commissioning software CTSoft to create, save, and load parameter files. You can download CTSoft from our website You will also need the communications cable, CT-USB-CABLE.</p> <p>Control Techniques Software Tools Downloads  <a href="https://acim.nidec.com/en-us/drives/control-techniques/downloads/software-tools">https://acim.nidec.com/en-us/drives/control-techniques/downloads/software-tools</a></p> <p>You can alternatively use the SMARTCARD that comes with the drive to externally save the drive's parameters and transfer them to other drives. To save parameters on the SMARTCARD insert it into the SMARTCARD slot on the front of the drive. Navigate to parameter 0.30 (or SE09 in the sub-block menu) and change the value to Prog. Press the red reset button on the keypad. This will write the parameters in the drive onto the card.</p> <p>To transfer the parameters from the SMARTCARD onto a drive, insert the SMARTCARD into the desired drive. Navigate to parameter 0.30 (or SE09 in the sub-block menu) and change the value to READ. Press the red reset button on the keypad. This will write the parameters on the SMARTCARD onto the drive. Perform a parameter save.</p> <p>Follow link for more detailed information on SMARTCARD use.  <a href="https://controltechniquesfaqhelp.zendesk.com/hc/en-us/article_attachments/360068198714/Mentor_MP_Using_Smartcard.pdf">https://controltechniquesfaqhelp.zendesk.com/hc/en-us/article_attachments/360068198714/Mentor_MP_Using_Smartcard.pdf</a></p>
<p>How do I size an enclosure for my Mentor MP DC Drive?</p>	<p>See section 3.6 of the Mentor MP user guide or section 3.5 of the Quantum MP user guide for the information and equation needed to calculate the size of a sealed enclosure.</p>
<p>How do I select an external suppression resistor for my Mentor MP DC Drive?</p>	<p>See section 4.7 of the Mentor MP user guide or section 4.10 of the Quantum MP user guide for information on sizing an external suppression resistor for your drive.</p>
<p>What cable size and fusing should I use with my Mentor MP DC drive?</p>	<p>See section 4.6 of the Mentor MP user guide or section 4.9 of the Quantum MP user guide for information on cable and fuse sizing, compiled in the pdf link below.  <a href="https://controltechniquesfaqhelp.zendesk.com/hc/en-us/article_attachments/360069318613/Mentor_MP_Cable_and_Fuse_Sizing.pdf">https://controltechniquesfaqhelp.zendesk.com/hc/en-us/article_attachments/360069318613/Mentor_MP_Cable_and_Fuse_Sizing.pdf</a></p>
<p>What size line reactor or choke should I use with my Mentor MP DC Drive?</p>	<p>See section 4.4 of the Mentor MP user guide, or the Quantum MP user guide for information on sizing line reactors for your drive.</p>
<p>How do I clear the "inh" status on my Mentor MP keypad display?</p>	<p>Apply 24 vdc to drive terminal 31, the enable terminal. Parameter 8.09 will show the status of the enable terminal, and parameter 6.29 will show if the drive is enabled or not.</p> <p>If 24 vdc is present at terminal 31, but the drive still shows Inh on the status screen check parameter 6.15 (the software enable). 6.15 should read ON. If it shows on, but the drive is still in the Inhibit state, turn 6.15 OFF and then turn it back ON again. You can also remove the 24 vdc from terminal 31 and reapply it for the same effect.</p> <p>See parameters 6.15, 6.29, and 8.09 in the Advanced User Guide Mentor MP for additional information. You can also find more details in sections 4.14 of the Mentor MP user guide, and section 4.16 of the Quantum MP user guide.</p>
<p>How do I reprogram the Mentor MP drive's analog input parameter destination from the default control setting?</p>	<p>First use figure 4-21 in the Mentor MP user guide to determine which analog input (input 1, input 2, or input 3) you are looking to reprogram.</p> <p>Next use section 11.7 of the Mentor MP or Quantum MP user guide to identify the destination parameter for your desired terminal (i.e. for analog input 1 it is parameter 7.10). Navigate to that parameter and edit the value to match the parameter you would like your selected analog input to point to.</p> <p>Press the red reset button on the keypad to make the change take effect.</p> <p>Perform a parameter save.</p> <p>How do I save the parameters to my Mentor MP drive?  <a href="https://controltechniquesfaqhelp.zendesk.com/hc/en-us/articles/360047288513">https://controltechniquesfaqhelp.zendesk.com/hc/en-us/articles/360047288513</a></p> <p>Where can I find user guides (basic and advanced) for the Mentor MP, Quantum MP, or FXMP25?  <a href="https://controltechniquesfaqhelp.zendesk.com/hc/en-us/articles/360047541293">https://controltechniquesfaqhelp.zendesk.com/hc/en-us/articles/360047541293</a></p>

Where can I find user guides (basic and advanced) for the Mentor MP, Quantum MP, or FXMP25?

The Mentor MP user guide and Quantum MP user guide covers safety information, product information, drive installation, basic drive and keypad operation, basic parameters, quick start commissioning, optimization, SMARTCARD operation, onboard PLC programming, advanced parameter menus, technical data, diagnostics, and UL information for their respective drives. The user guides can be downloaded from our website through the links below:

Mentor MP Product Page  
<https://acim.nidec.com/en-us/drives/control-techniques/products/dc-drives/mentor-mp>

Quantum MP Product Page  
<https://acim.nidec.com/en-us/drives/control-techniques/products/dc-drives/quantum-mp>

FXMP25 Product Page  
<https://acim.nidec.com/drives/control-techniques/products/dc-drives/fxmp25>

The Advanced User Guide Mentor MP covers parameter structure, the keypad and display, parameter xx.00, the parameter reference guide, serial communications protocol, and performance for both the Mentor MP and Quantum MP drives. It can be also downloaded from the links above.

Where can I find the part number, voltage, and power rating information label on my Mentor MP Drive or Quantum MP?

The rating label can be found on the upper left hand corner of the drive cover.



How do I restore my Quantum MP drive back to factory default settings?

For the Quantum MP, first follow the steps required to set the Mentor MP back to factory default settings, through the link below:

How do I restore my Mentor MP back to factory default settings?

Next, look at section 5.9 of the QMP user guide.

Where can I find documented safety information about my Mentor MP or Quantum MP drive?

All safety information can be found in Chapter 1 of the Mentor MP or Quantum MP user guide. Please follow one of the links below to be taken to the respective product page to download the applicable manual.

Mentor MP Product Page  
<https://acim.nidec.com/en-us/drives/control-techniques/products/dc-drives/mentor-mp>

Quantum MP Product Page  
<https://acim.nidec.com/en-us/drives/control-techniques/products/dc-drives/quantum-mp>

How do I restore my Mentor MP back to factory default settings?

For the Mentor MP navigate to parameter 00 in any menu. Press the mode button to enter edit mode and scroll up to find the parameter value that reads USA (or EUR for European defaults). Press the red reset button on the keypad. Then perform a parameter save.

How do I save the parameters to my Mentor MP drive?  
<https://controltechniquesfaqhelp.zendesk.com/hc/en-us/articles/360047288513>

Using the Mentor Drive IO

In our existing DC Drive installation some of our I/O devices are 120VAC and we prefer to use the existing devices, is this possible when we install the new Quantum or Mentor MP drive?

Yes, the Quantum MP drive as one slot designated for the 120VAC I/O option module. This option module can also be used on a Mentor MP (SM IO 120V).

SM IO 120V Product Page

<https://acim.nidec.com/en-us/drives/control-techniques/products/options-and-accessories/inputs-outputs-option-modules/sm-io-120v>

How do I reconfigure the function of one of my Mentor MP drive's digital outputs?

First use figure 4-21 in the Mentor MP user guide to determine which digital I/O (I/O 1, I/O 2, or I/O 3) you are looking to reprogram. (Note that some Digital IO can be configured as Inputs or Outputs via parameter 8.31, 8.32, or 8.33).

Next use section 11.8 of the Mentor MP or Quantum MP user guide to identify the corresponding output select parameter to make the I/O point an output (make sure that parameter is ON to make the terminal in question an output). Use section 11.8 of the Mentor MP or Quantum MP user guide to identify the corresponding source parameter (i.e. for digital I.O 1 it is parameter 8.21). Once that is done navigate to source pointer parameter that matches your terminal and edit the value to your desired parameter source. Press the red reset button on the keypad to make the change take effect.

Perform a parameter save.

How do I save the parameters to my Mentor MP drive?

<https://controltechniquesfaqhelp.zendesk.com/hc/en-us/articles/360047288513>

Where can I find user guides (basic and advanced) for the Mentor MP, Quantum MP, or FXMP25?

<https://controltechniquesfaqhelp.zendesk.com/hc/en-us/articles/360047541293>

How do I change the output scaling factor of my Mentor MP drive's analog output?

First use figure 4-21 in the Mentor MP user guide to determine which analog output (output 1, or output 3) you are looking to adjust the scaling on.

Next use section 11.7 of the Mentor MP or Quantum MP user guide to identify the output scaling parameter for your desired terminal (i.e. for analog output 1 it is scaling parameter is 7.20). Navigate to that parameter and edit the value to match the source parameter for your analog output. Press the red reset button on the keypad to make the change take effect.

Perform a parameter save.

How do I save the parameters to my Mentor MP drive?

<https://controltechniquesfaqhelp.zendesk.com/hc/en-us/articles/360047288513>

Where can I find user guides (basic and advanced) for the Mentor MP, Quantum MP, or FXMP25?

<https://controltechniquesfaqhelp.zendesk.com/hc/en-us/articles/360047541293>

How do I reprogram my Mentor MP drive's analog output from the factory setting?

First use figure 4-21 in the Mentor MP user guide to determine which analog output (output 1, or output 2) you are looking to reprogram.

Next use section 11.7 of the Mentor MP or Quantum MP user guide to identify the source parameter for your desired terminal (i.e. for analog output 1 it is parameter 7.19 which is defaulted to 3.02). Navigate to that parameter and edit the value to match the source parameter for your analog output. Press the red reset button on the keypad to make the change take effect.

Perform a parameter save.

How do I save the parameters to my Mentor MP drive?

<https://controltechniquesfaqhelp.zendesk.com/hc/en-us/articles/360047288513>

Where can I find user guides (basic and advanced) for the Mentor MP, Quantum MP, or FXMP25?

<https://controltechniquesfaqhelp.zendesk.com/hc/en-us/articles/360047541293>

How do I change the input scaling of the drive's analog input on an Mentor MP?

First use figure 4-21 in the Mentor MP user guide to determine which analog input (input 1, input 2, or input 3) you are looking to reprogram.

Next use section 11.7 of the Mentor MP or Quantum MP user guide to identify the input scaling parameter for your desired terminal (i.e. for analog input 1 it is scaling parameter is 7.08). Navigate to that parameter and edit the value to match the scaling you require on the analog input. Press the red reset button on the keypad to make the change take effect.

Perform a parameter save.

How do I save the parameters to my Mentor MP drive?

<https://controltechniquesfaqhelp.zendesk.com/hc/en-us/articles/360047288513>

Where can I find user guides (basic and advanced) for the Mentor MP, Quantum MP, or FXMP25?

<https://controltechniquesfaqhelp.zendesk.com/hc/en-us/articles/360047541293>

#### Using the Mentor Keypad

How do I switch between the sub block menus and linear menus on the keypad for a Mentor MP?

In the sub-block menu navigate to parameter SE14. Press the mode button to enter edit mode and change the value from L1 to L2. You will now be in the linear menu on parameter 0.35.

In the linear menu navigate to either parameter 0.35 or 11.44. Press the mode button to enter edit mode and change the value from L2 to L2. You will now be in the sub-block menu on parameter SE14.

See sections 5.3 – 5.7 of the Mentor MP or Quantum MP user guide for more details.

Mentor MP Product Page

<https://acim.nidec.com/en-us/drives/control-techniques/products/dc-drives/mentor-mp>

How do I save the parameters to my Mentor MP drive?

If you are making changes in either the sub-block menus, or menu 0 of the linear menus then all parameter changes are automatically saved.

If you are in the advanced menus then after you have made your changes, navigate to parameter 00 in any menu. The user guides will display this as xx.00. Press the mode button to enter edit mode, scroll up, and find the parameter value that reads SAVE. Press the red reset button on the keypad to complete the save.

How do I use the keypad on my Mentor MP DC drive?

The left and right arrow keys on the keypad will move you through the menus/headers. The up and down arrow keys on the key-pad will move you through the parameters of the menu/header you are currently on.

The mode button (black button with an M on it) will cycle you through the display modes – parameter view, parameter edit, and status screen. When an item is blinking on the screen, the arrows will allow you to edit the value.

# PTi210

Question	Answer
<b>Mobile Inputs and Outputs</b>	
What voltage will cause the PTi210 inputs to turn on?	The input turn-on voltage is 15 Vdc +/- 0.5 Vdc
What are the PTi210 digital input voltage ratings?	The inputs are rated for +24 Vdc with a maximum input voltage of +30 Vdc.
What are the current ratings for the PTi210 digital outputs?	The 2 outputs are rated for 20 mA total.
Are the PTi210 I/O sinking or sourcing?	The PTi210 are electrically sourcing I/O. All I/O utilize positive logic meaning they are active when a positive voltage is applied. Refer to Figure 3-2 in the PTi210 user guide for a wiring diagram. The PTi210 module has a single terminal block allowing screwless terminal access to the digital I/O. The terminals are numbered from Terminal 1 to 3 on the upper row (left to right) and Terminals 4 to 6 on the bottom row (left to right).
How many inputs and outputs are on the PTi210?	The PTi210 has 3 digital inputs and 2 digital outputs. The first two digital inputs are designed for high speed capture, but they can also be used as a regular input.
<b>Hardware Installation</b>	
I just replaced a drive that had a PTi210 module fitted to one of the drive slots. Do I need to fit the PTi210 module in the same slot where it was removed from?	Yes, when replacing a drive that has a PTi210 and any other working solutions modules each module needs to be put back into the exact same drive slot in the new drive.
Are PTi210 modules hot swappable?	No, remove all power from the drive before removing or adding PTi210 or any other solutions option modules.
Do I need any additional options to install a PTi210 to a Digitax HD (M750 or M751) drive?	Yes, the SI-Option Mounting kit order code 9500-1055 must be ordered separately to allow proper fitting of the PTi210 and any other option modules to the drive.
Do I need any additional options to install a PTi210 to a Unidrive M700, M701 or M702?	No, any empty drive slot can be used to fit the PTi210 module.
<b>Module Programming</b>	
How do I control the brake on a motor with PowerTools Studio and the PTi210 on a Digitax HD?	<p>First, modify the drive initialization file in PowerTools Studio. The Drive Initialization File can be found under the Hardware tree in PowerToolsStudio. If it is not there, enable it to be view or edited by selecting Options/Preferences/Show Advanced Views.</p> <p>Next, insert the following lines into the code:</p> <p>Menu.12.41=1 - this instruction set the brake control to Enable.</p> <p>Menu.8.22=12.040 - this sets the Digitax HD Brake Release function to be the source of the SP Relay.</p> <p>Next, remove or comment out the following line:</p> <pre> Menu.8.21 = 18.039 *IO 1 Source Destination Menu.8.22 = 18.040 *IO 2 Source Destination Menu.8.24 = 0.00 *Input 4 Source Destination Menu.8.25 = 0.00 *Input 5 Source Destination Menu.8.28 = 0.00 *24V output Source Destination Menu.12.041 = 1 *Enable Brake control to On Menu.8.22 = 12.040 *IO 2 Source Destination for the Brake status </pre> <p>Menu.8.22=18.040 - IO 2 Source Destination.</p> <p>This is the preferred method of controlling the brake when PTi210 is used. In actuality, the Digitax HD is doing all the control, and PTi210 is simply telling the drive to take over.</p>

<p>How do I erase the program and reset a PTi210 back to factory default defaults?</p>	<p>The user will need a drive keypad or Connect software. Set 18.001 = 19237 and cycle power to the drive. After the drive has completed powering back up there should be a Slot Error for the slot where the PTi210 is fitted indicating there is no program in the module.</p>
<p>Can I download a program to a PTi210 while the drive is enabled in a Ready or Run state?</p>	<p>No, the drive must be disabled / inhibited to download a program to a PTi210.</p>
<p>I just installed a new drive and am reusing the PTi210 module from the drive that failed since it is still functional. Do I need to re-program the PTi210?</p>	<p>No, the program for the PTi210 resides in the module NVM. If the same exact program is going to be used downloading is not required.</p>
<p>Can I use "Upload" to go online with a new out of box PTi210?</p>	<p>No. There is no program in a brand new PTi210 module so a program must be downloaded first to a new PTi210 before upload can be used to go online with the module.</p>
<p>Do I have to save parameters in the drive after downloading a program to the PTi210?</p>	<p>No, the PTi210 has its own microprocessor, and performing a download to the PTi210 writes the program contents directly to NVM (non-volatile memory).</p>
<p>Can I pre-program a PTi210 module for later use on a compatible drive?</p>	<p>Yes, it is recommended to pre-program the module by fitting the PTi210 to the same drive type and size that it will be used on by downloading the desired program using PowerTools Studio software. After downloading the program to the PTi210 it can be removed for use later time in the same drive slot that it was originally programmed in.</p>
<p>I cannot find my SI module in the PowerTools Studio Slot Configuration Module Type drop down list. How do I program this module?</p>	<p>For Module Type select 'Empty Slot' for the Slot # where this module is fitted to the drive. The module can then be setup using the drive keypad or Connect software.</p>
<p>How do I change the Ethernet IP address on a drive that has a PTi210?</p>	<p>In PowerTools studio click on the '&gt;' next to Hardware and then click on Comms Slot – Onboard Ethernet for M700, M702 or M750 drives and enter the new IP address in Setup, and check the box next to Change Ethernet Settings. Download the changes.  For M701 or M751 drives with SI-Ethernet fitted to one of the drive slots click on the '&gt;' next to Hardware and then click on the Slot # where SI-Ethernet is fitted and enter the new IP address in Setup, and check the box next to Change Ethernet Settings. Download the changes.</p>
<p>My drive with a PTi210 keeps losing it's IP address on a power cycle. Why is this happening?</p>	<p>The IP address is stored in the PTi210 module settings and must be changed using the PowerTools Studio software.</p>
<p>How many drive slots are available in PowerTools Studio software for Solutions Integration (SI) modules?</p>	<p>The number of available drive slots depends on the drive being used with the PTi210.  For M700, M701 &amp; M702 there are 2 drive slots available for other SI-Modules after installing the PTi210.  For the M750 &amp; M751 there is one drive slot available after installing the PTi210.</p>
<p>What programming cable is needed to program a M700, M702 or M750 with PTi210 using PowerTools Studio software via Ethernet?</p>	<p>A standard Cat5e or Cat6 Ethernet patch cable can be used.  For M701 or M751 drives that have SI-ETHERNET fitted to the drive a standard Cat5e or Cat6 Ethernet patch cable can be used to program the drive.</p>
<p>What programming cable is needed to program a M701 or M751 drive using PowerTools Studio that has no SI modules fitted to the drive?</p>	<p>You can use the standard CT-USB-CABLE serial programming cable as a USB to Serial interface from your local PC.</p>
<p>Where can I download PowerTools Studio software?</p>	<p>You will be able to download PowerTools Studio software at the Software Downloads section of Control Techniques' website when it is fully released later in 2020.</p>
<p>Does PowerTools Pro v6.0 work with the PTi210 Motion Made easy module?</p>	<p>No, it does not. You will need to use PowerTools Studio software for programming and commissioning the PTi210 Motion Made Easy module.</p>

General Topics

Do I need AC Input supply power on my drive to program or go online with a PTi210?

No, the user can provide external +24 Vdc to the appropriate drive terminals to go online with or program a new or existing PTi210 module.

Can I use a SD card to back up my PowerTools Studio program?

No, the SD card cannot be used to save a PowerTools Studio program. The user must use PowerTools Studio software to save a program for the PTi210.

The picture below shows the 3 drive slots for M700, M701 and M702 drives:



The picture below with 2 drive slots show slot locations for M750 and M751 drives:



How can I visually tell if the PTi210 is being used with my drive?

Look for any SI module with royal blue plastic on the bottom of the module; this color is used to identify the PTi210 as seen below:



How can I tell if my drive has a PTi210 module fitted to one of the drive slots using the drive keypad?

For M700, M701 and M702 drives, navigate to drive parameters 15.001, 16.001 & 17.001; if any of these parameters equals 320 this indicates PTi210 is fitted to the respective drive slot. 15.001 is drive Slot 1 Module ID, 16.001 is drive Slot 2 Module ID & 17.001 is drive Slot 3 Module ID.

For M750 (Digitax HD) and M751 (Digitax HD) drives, navigate to drive parameters 15.001, 16.001; if either of these parameters equals 320 this indicates PTi210 is fitted to the respective drive slot. 15.001 is drive Slot 1 Module ID and 16.001 is drive Slot 2 Module ID.

Do I need to provide an external +24 Vdc power supply to use the PTi210 I/O?

Yes, the user must provide an external +24 Vdc power supply.

If my computer supports it, can I use a standard serial cable to program a Digitax HD (M751) or M701 drive using PowerTools Studio software?

No, the CT-USB-CABLE has a built in RS232 to RS485 converter that is needed to program a drive. Also note that the drive must have a PTi210 module attached to it to support PowerTools Studio.



How can I get my saved .EZM or .EZME file to work with the PTi210?

You will need to open a new file in PowerTools Studio software and manually recreate your program. You can use Cut/Copy-Paste for user programs, however, be careful of any references made to drive or module inputs, drive or module outputs or menu parameters as the syntax may have changed. For example: 18.01 is now 18.001 in the PTi210.

File -> Import is a feature that is being slated for a future release of PowerTools Studio software for importing file types .EZM and .EZME into PowerTools Studio. Please check back soon for future updates supporting this feature.

Will PowerTools Studio software open my saved program I am using with SM-EZ Motion?

No, it will not. PowerTools Pro v6.0 is needed to open any .EZM or .EZME file types.

Where do I find information about Digitax HD with PTi210?

Please visit our control techniques website to find information for the following drives:

<https://acim.nidec.com/en-us/drives/control-techniques/products/servo-drives/digitax-hd/digitax-m750-ethernet>

Servo - Digitax HD

High Performance - Unidrive M700

General Purpose - Commander C



# SOFTWARE TOOLS

Question	Answer
<b>CT Scope Software</b>	
How do I setup different channels to monitor multiple parameters through CTScope in my Control Techniques drive?	<a href="https://youtu.be/5m58PGZdFyc">https://youtu.be/5m58PGZdFyc</a>
How do I use CTScope to monitor parameters and settings in my Control Techniques drive?	<a href="https://youtu.be/Udib-IPgrPI">https://youtu.be/Udib-IPgrPI</a>
<b>Machine Control Studio</b>	
How can I start a new Machine Control Studio project for an MCI200 or MCI210?	<a href="https://youtu.be/QWX13-UG65k">https://youtu.be/QWX13-UG65k</a>
How can I access SI-IO option module parameters through Machine Control Studio for use in my drive program?	<a href="https://youtu.be/jkoHGWK_5Ts">https://youtu.be/jkoHGWK_5Ts</a>
<b>Connect Software</b>	
Where can I download Connect, CT Scope, or Machine Control Studio Software?	Please visit the "download" section of our Control Techniques website via the link below: Control Techniques Software Downloads: <a href="https://acim.nidec.com/en-us/drives/control-techniques/downloads/software-tools">https://acim.nidec.com/en-us/drives/control-techniques/downloads/software-tools</a>
If I want to copy or clone one drive to another existing drive, how can I use Connect software to do so?	<a href="https://youtu.be/rM1vyloneMM">https://youtu.be/rM1vyloneMM</a>
How do I use Connect software to compare the settings in my drive to the default settings for the drive, and produce me a detailed list?	<a href="https://youtu.be/lqzIHZK0EPg">https://youtu.be/lqzIHZK0EPg</a>
How can I update the option module firmware for an option module attached to my Control Techniques drive?	<a href="https://youtu.be/lzXln-DH4iw">https://youtu.be/lzXln-DH4iw</a>
How can I update my drive firmware on my Control Techniques drive using Connect software?	<a href="https://youtu.be/tw2FllvFvR8">https://youtu.be/tw2FllvFvR8</a>
How can I save, upload, or backup parameter files from my Control Techniques drive to my computer?	<a href="https://youtu.be/2hPntRaCU2I">https://youtu.be/2hPntRaCU2I</a>
How can I program my KI-Keypad for a different language using Connect software?	<a href="https://youtu.be/61PmYMIzddI">https://youtu.be/61PmYMIzddI</a>

# OTHER TOPICS

Question	Answer
<b>Other Topics</b>	
Where can I get drawings for Nidec US Motors brand motors?	Please visit the US Motors "MotorBoss" page by following the link below: Motor Boss E-Catalog: <a href="http://ecatalog.motorboss.com">http://ecatalog.motorboss.com</a>
Can I use a single phase motor with my CT drive?	CT drives are not intended for single phase output operation.
How do I find my drive model or serial number?	All drive model numbers and serial numbers are located on the drive identification label, typically near the top of the drive. Note, you may need to remove an option module or keypad to find this label.
How do I find out where I can purchase CT drives and components?	Find your local distributor(s) by following the link below: CT Distributor Locator: <a href="https://acim.nidec.com/en-us/drives/control-techniques/distributor-locator">https://acim.nidec.com/en-us/drives/control-techniques/distributor-locator</a> or email us at: <a href="mailto:customerservice.cta@mail.nidec.com">customerservice.cta@mail.nidec.com</a>
<b>Drive Diagnostics</b>	
Where can I download CT's "Diagnostic Tool" to troubleshoot drive trips right from my phone?	The CT Drive Diagnostic tool can be installed on any mobile device, and provides the user with quickstart guides, wiring diagrams, and quick access to the explanation for any drive error code for fast any easy troubleshooting. Please use the link below to be directed to CT's website, or you can find the application on your mobile app store. CT Drive Diagnostic Tool: <a href="https://acim.nidec.com/en-us/drives/control-techniques/downloads/mobile-applications">https://acim.nidec.com/en-us/drives/control-techniques/downloads/mobile-applications</a>
<b>Field Service</b>	
I need a Control Techniques engineer or technician to come to my site to help setup or troubleshoot my drive. How do I start that process?	Please fill out our online request form, you should receive a quote or feedback within a few hours for onsite assistance or virtual support via Teamviewer or Webex. Field Service Request Page: <a href="https://acim.nidec.com/en-us/drives/control-techniques/service-and-support/field-service">https://acim.nidec.com/en-us/drives/control-techniques/service-and-support/field-service</a>
<b>Drive Communications</b>	
How do I determine the Modbus address for a parameter on my drive?	<b>IMPORTANT!</b> To access parameters in a drive menu (not a slot menu), a Modbus Unit Identifier must be used and set to either 0 or 255 from the master device.  The Modbus addressing method is chosen using Pr. 4.15.013. Default is ""0"" for Standard Addressing. Change Pr. 4.15.013 to ""1"" to use Modified Addressing. Use Modified mode when accessing parameter numbers that are greater than ""99"" within their menu.  To access parameters in drive slots 1, 2 or 3 you must change the Modbus Unit Identifier to match the Slot Number. For example: To access a parameter in slot #3, change the Modbus Unit Identifier to ""3"". Option Slot parameters are addressed using Standard mode only. (4.15.013 = 0/Standard).  See table below for parameter mapping examples, note the addressing differences between 16-bit and 32-bit parameters.
What cable do I need to communicate with my CT drive via a serial link from my computer?	We recommend acquiring a CT-USB-CABLE to communicate or go online with the drive via a serial link. If your selected drive Commander C or Unidrive M) does not already have an RS485 communication port, you may also need to purchase a AI-485 Adapter.
What kind of add on communication option modules are available for my CT drive?	The best place to find this information is on our Control Techniques website, please follow the link below: Control Techniques Option Modules: <a href="https://acim.nidec.com/en-us/drives/control-techniques/products/options-and-accessories">https://acim.nidec.com/en-us/drives/control-techniques/products/options-and-accessories</a>
Can you show me in a video how I can access drive parameters using Modbus TCP or Modbus RTU from a communication master?	<a href="https://youtu.be/ZAL3YhEVyuk">https://youtu.be/ZAL3YhEVyuk</a>
<b>Drive Training</b>	
How can I sign up for the Control Techniques Online Learning Center?	<a href="https://youtu.be/jvnbY2fyTzI">https://youtu.be/jvnbY2fyTzI</a>

# DISCOVER MORE



# BIG BOOKS



## THE 100

The Big Book of Case Studies for every one of our solutions.



## THE HERO'S JOURNEY

The Big Book about our Drives being the unsung heroes.



## THE ORIGIN

The Big Book of the full Control Techniques History.

# GREEN BOOKS



## ELECTROMAGNETIC COMPATIBILITY



## HARMONICS



## SAFE TORQUE OFF







## CONTROL TECHNIQUES IS YOUR GLOBAL DRIVES SPECIALIST.

With operations in over 70 countries, we're open for business wherever you are in the world.

For more information, or to find your local drive centre representatives, visit:

[www.controltechniques.com](http://www.controltechniques.com)

Connect with us



©2020 Nidec Control Techniques Limited. The information contained in this brochure is for guidance only and does not form part of any contract. The accuracy cannot be guaranteed as Nidec Control Techniques Ltd have an ongoing process of development and reserve the right to change the specification of their products without notice.

Nidec Control Techniques Limited. Registered Office: The Gro, Newtown, Powys SY16 3BE.

Registered in England and Wales. Company Reg. No. 01236886.

0781-0465-01 02/21

