

ENERPAC®

POWERFUL SOLUTIONS. GLOBAL FORCE.



US

E 3 2 9

INDUSTRIAL TOOLS

Page(s) ▼	Page(s) ▼	Page(s) ▼	Page(s) ▼
A	ER	N	SPD
A 132-135, 136, 158, 197	194-195	NC	188-189
A5-A10 ..	ES	NCB	SPK
186-187	194-195	251	188
A12	ETW	NS	SPMT
10	228-230	253	270
A13-A28 ..	EVO	NV	SRSX
186-187	120-121	145	209
A29-A53	F	P	STB
10	F	P	200-201
A64-A66	134-135	P392AL	STC
136	FF	54, 70-76, 78-79	198
A92	258-259	71	STF
197	FH	P392FP	254-255
A102	135	76	STN
10, 33	FR	104	STP
A128-A192	135	PA	189
186-187	FRL	PAM	T
A185	227	105	T
187	FS	PAMG	135, 142
A200R	254	106-107	THC
158	FSB	PATG	238, 241-242
A205-A220	255	106-107	THQ
156-157	FSH	PARG	238, 241-242
A218	255	106-107	TM
186-187	FSM	PC	160
A242-A305	255	70, 72, 104	TQ
186-187	FZ	84-87, 102-103	234-235
A252	137	PE	TSP
10	G	PEM	209, 225
A258	G	84-85, 102-103	V
156-157	GA	PEJ	V
A310, A330	140-141	84-85	54, 145-147
156-157	GB	PER	VA-2
A530-A595	144-145	84-85, 102-103	105
186-187	GBJ	PES	VC
A604	57	84-85	126-127
134-135	GF	PK	VE
A607	138-139	158	124-129
186-187	GP	PL	VM
A630	138-139	60-61	124-125, 127
134-135	GPS	PMB	VS
A650	172	158	128
186-187	GT	PMU	W
AD	246-247	233	W
31, 158	H	PR	212-223
AH	H	58-59	WCB
132-133	HA	PTW	198-199
AM	133	226-227, 230	WCR
136	HB	PU	224
AR	133	82-83	WHC
132-133	HC	R	198
ATM	36-43	RA	WHR
256-257	HCL	12-13	198
ATP	36, 48-51	RACH	WMC
250	HCR	16-17	199
AW	36, 44-47	RACL	WR
10	HF	14-15	197
B	HP	RAR	WRP
B	27, 29	8-19	225
250	HSK	RB	WTE
BFZ	262-263	RC	225
137	HSL	6-10, 54-55	X
BH	264-265	RCH	XA
250	HPT	26-27	108-109
BHP	248	RCS	XC
164-167, 173	HT	22-23	80-81
BLS	250	RDM	XLK1
62-63	I	30-31	108
BR	IP	REB	XPG1
250	IP 150-154, 156-157	10	108
BRC	IPK	REP	XSC1
24-25	IPK	10	108
BRP	IPL	RFL	Z
24-25	IPR	109	Z
BRP	158	RR	Z
24-25	154-155	32-35	135
BSH	J	RRH	ZA4
210	JBI	28-29	110-111
BW	JH	RSM	ZA4T
250	JHA	22-23	242-245
BZ	JS	RTEX	ZC
201	268-269	209	94-95, 100-101
C	L	RWH	ZCP
C	LH	164-165	125
132-135	160	S	ZE
CAT	LL	S	96-99, 240-241
10, 23	116-117	206-208	ZG
CATG 15, 19, 41, 43, 45	LPL	SB	112-114
CD	20-21	255	ZH
135	LW	SBL	95, 101, 239
CH	192	266-267	ZL
132-133	136	SBZ	94-95, 100-101
CM	M	94, 100, 239, 245	ZP
196	MBL	SC	94-95, 100-101, 239
CR	266-267	52-53	ZU4
135	MP	SCH	88-95
CT	77	53	ZU4T
135	MPS	SCL	236-239
CW	171	53	ZUTP
164-165	184-187	SCR	249
D	MS	SDA	ZTM
DGR	189	208	239, 245
143	MZ	SFP	Numeric
E	186-187	118-119	11
E	MP	SGH	78-79, 142
204-205	77	168-169, 172	41
ELB	MPS	SGM	79
194	171	168-170	43
ELP	184-187	SHS	79, 142
194-195	MSP	64-65	45
EMB	189	SHAS	79
194	186-187	64-65	72-750
EP	MZ	266-267	78
174-181	177	SOH	79, 142
EPH	177	193	83
178-181	EPX	188-191	
EPP	177		
174-177			
EPT			
178			
EPX			
177			



Cylinders and Lifting Products

Page 4-67



Pumps & Directional Control Valves

Page 68-129



System Components & Control Valves

Page 130-147



Presses

Page 148-161



Pullers

Page 162-181



Tools

Page 182-201



Bolting Tools

Page 202-259



Heavy Lifting Equipment

Page 260-272

The World Class Brand

A complete range of quality high-force tools for all industrial applications, with local availability and after sale service anywhere in the world.... this is what has made Enerpac the undisputed global market leader in high-pressure hydraulics.

Across every continent, Enerpac's network of authorized distributors and service centers can reach even the most remote locations, supplying and servicing products that are designed to enhance productivity and performance, while making the workplace safer.

With over 150 sales specialists and a network of service and engineering support in 17 countries across the globe, Enerpac has become the product of choice in industries such as manufacturing, construction, energy, oil and gas, shipbuilding, railroads, mining, and metals transformation.

Always at the leading edge of technology, Enerpac has continued to develop its range of time and cost-savings tools, utilizing modern engineered materials to improve productivity and minimize operator fatigue.

Enerpac's commitment to the continued development of quality high force tools ensures that the products you purchase are the best tools in the industry. We will continue to lead the way in the development of quality high force tools for all industrial applications.



10 Reasons to Work with Enerpac

- Expert Design
- Highly Reliable
- Service Excellence
- Worldwide Experience
- Application Support
- Availability
- Quality
- Value
- Innovative Products
- Systems Solutions



Total Quality

Our products are tested to the most exacting standards. These high standards guarantee the quality, price and performance requirements of the markets we serve around the globe.

Global Network

Enerpac has an extensive network of authorized distributors and service centers located in more than 90 countries worldwide. You can rely on Enerpac for the products and technical support you need to get your job done, anywhere in the world.

Logistics Excellence

Enerpac's mission is to maintain service excellence in the ever-changing world of modern distribution. Providing our extensive range of products to our thousands of distributors worldwide demands a logistic expertise only a market leader can provide.

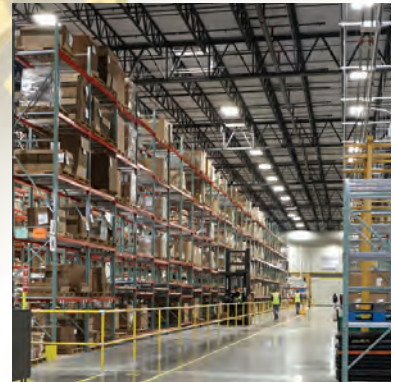

A Tradition of Innovation

Enerpac has a long history of finding new solutions to better meet the challenges of the industries we serve. We were the first to develop a composite hand pump and the first to offer a computerized lifting system. Our latest innovations include the XA-Series of air driven foot pumps, designed for less operator fatigue - with the unique XVARI® technology, delivering variable oil flow and fine metering for precise control, a full range of aluminum cylinders with the strength of steel and the advantages of aluminum and the Z-Class series of power pumps... pumps that were designed to run cooler, use less electricity and are easy to service.

To support the demands of the construction industry, Enerpac continues to develop Heavy Lifting Technologies. These technologies include controlled hydraulic movement for your most challenging applications.

ENERPAC®

POWERFUL SOLUTIONS. GLOBAL FORCE.

Enerpac hydraulic cylinders are available in hundreds of different configurations. Whatever the industrial application... lifting, pushing, pulling, bending, holding... whatever the force capacity, stroke length, or size restrictions... single- or double-acting, solid or hollow plunger, you can be sure that Enerpac has the cylinder to suit your high force application.

Enerpac jacking cylinders fully comply to ASME B30.1 (except RD-Series).



GR2 Bearing Technology



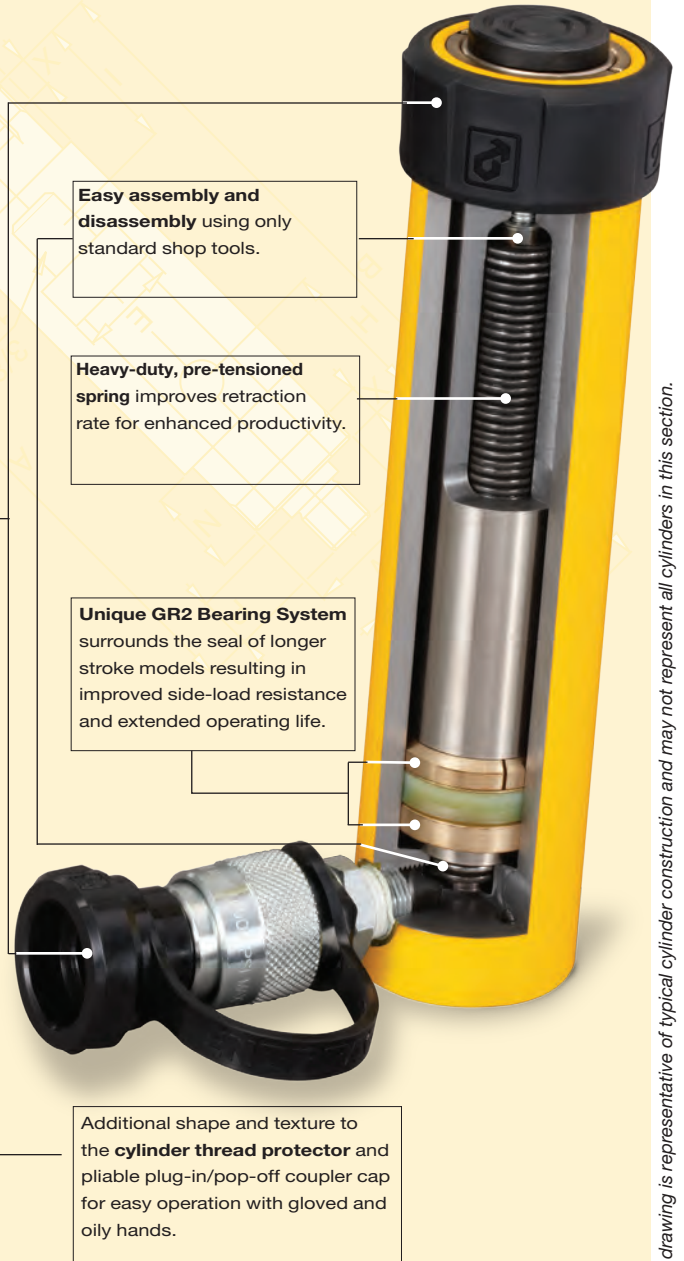









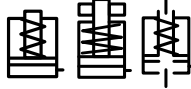



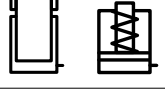



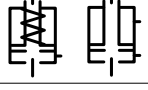







The exclusive GR2 is a unique bearing design on RC-Series DUO cylinders which absorbs eccentric load stresses to protect your cylinder against abrasion, over-extending or plunger blow-outs and jamming or top-end mushrooming. As a result, RC-Series DUO cylinders provide long, trouble-free operation.



Note: The cut-away drawing is representative of typical cylinder construction and may not represent all cylinders in this section.



Cylinder & Lifting Products Section Overview

* Capacity (tons)	Stroke Range (in)	Cylinder Type and Functions	Series		Page
5-100	.63-14.25	General Purpose Cylinders, Single-acting Cylinder Accessories 	RC-DUO		6 ▶ 10 ▶
20-150	1.97-9.84	Aluminum Cylinders Single-Acting, Solid Plunger, Lock Nut, Hollow Plunger 	RAC RACL RACH		12 ▶ 14 ▶ 16 ▶
20-150	1.97-9.84	Aluminum Cylinders Double-Acting Solid Plunger 	RAR		18 ▶
5-500	.25-2.44	Pancake and Low Height Cylinders, Single-Acting 	LPL RSM RCS		20 ▶ 22 ▶ 23 ▶
2.5-60	5.00-6.00	Pull Cylinders, Single-Acting 	BRC BRP		24 ▶
12-150	.31-10.13	Hollow Plunger Cylinders Single- and Double-Acting 	RCH RRH		26 ▶ 28 ▶
4-25	1.13-10.25	Precision Production Cylinders, Double-Acting 	RD		30 ▶
10-500	2.25-48.00	Long Stroke Cylinders, Double-Acting 	RR		32 ▶
50-1000	1.97-11.81	High Tonnage Cylinders Single-Acting (S/A), S/A with Mechanical Locknut, Double-Acting 	HCG HCR HCL		36 ▶ 44 ▶ 48 ▶
5-100	1.50-14.25	Cylinder - Pump Sets (Single-Acting) 	SC		52 ▶
5-25	2.0-6.0	Extreme Environment Products (Valves, cylinders, hand pumps)	RC P V		54 ▶
5-50	.44-10.13	Portable Hydraulic Toolbox	SCR SCL SRS		55 ▶
7-150 2-100	3.00-6.13 2.44-18.11	Aluminum and Steel Jacks Industrial Bottle Jack 	JH/JHA GBJ		56 ▶ 57 ▶
60-200	14.0-27.0	POW'R-RISER® Lifting Jack 	PR		58 ▶
200	14.0 / 24.5	Pow'R-LOCK™ Portable Lift System	PL		60 ▶
55-220	5.91-6.34	Climbing Jacks	BLS		62 ▶
60-250	19.69-59.06	Synchronous Hoisting Systems	SHS SHAS		64 ▶

* All cylinder capacities are nominal values, unless otherwise stated. [Maximum] capacities are theoretical and may vary, depending on cylinder condition and application.

▼ Shown from left to right: RC-506, RC-50, RC-2510, RC-154, RC-10010, RC-55, RC-1010



- Unique GR2 Bearing Design, reduces wear, extending life
- Collar threads, plunger threads and base mounting holes enable easy fixturing (on most models)
- Designed for use in all positions
- High strength alloy steel for durability
- Redesigned cylinder thread protector for ease of use
- Heavy-duty, pretensioned spring improves retraction speed
- Baked enamel finish for increased corrosion resistance
- CR-400 coupler and dust cap included on all models
- Plunger wiper reduces contamination, extending cylinder life

The Industry Standard General Purpose Cylinder



Saddles

All RC cylinders (except RC-50, 101) are equipped with hardened removable grooved saddles. For tilt and flat saddles, see the RC-Series accessory page.

Page: 10

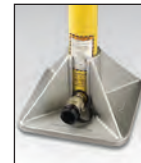

Base Plates

To ensure the stability of cylinders for lifting applications, base plates are available for 10, 25 and 50 ton RC cylinders.

Page: 10



Specialty Attachments

For solving all kinds of application problems, specialty attachments are available for 5, 10 and 25 ton RC cylinders.

Page: 187

▼ To re-stabilize the foundation, the 308-ton silo needed to be lifted, levelled and structurally supported. Twenty-five ton RC-Series hydraulic cylinders were attached to a bracket on the top of each steel pier. Powered by a Z-Class pump, the hydraulic cylinders applied 20 tons of force at each placement to lift the silo two inches.



▼ RC cylinder mounting attachments greatly extend the application possibilities (available for 5, 10, 15 and 25 ton cylinders).



Single-Acting, General Purpose Cylinders



GR2 Bearing Technology

The exclusive GR2 is a unique bearing design on RC-Series DUO cylinders which absorbs eccentric load stresses to protect your cylinder against abrasion, over-extending or plunger blow-outs and jamming or top-end mushrooming. As a result, RC-Series DUO cylinders provide long, trouble-free operation.

▼ QUICK SELECTION CHART

For complete technical information see next page.

Cylinder Capacity	Stroke	Model Number	Cylinder Effective Area	Oil Capacity	Collapsed Height	Weight
tons (maximum)	(in)		(in ²)	(in ³)	(in)	(lbs)
5 (4.9)	.63	RC-50**	.99	.62	1.63	2.2
	1.00	RC-51	.99	.99	4.34	2.3
	3.00	RC-53	.99	2.98	6.50	3.3
	5.00	RC-55*	.99	4.97	8.50	4.1
	7.00	RC-57	.99	6.96	10.75	5.3
	9.13	RC-59	.99	9.07	12.75	6.1
10 (11.2)	1.00	RC-101	2.24	2.24	3.53	4.0
	2.13	RC-102*	2.24	4.75	4.78	5.1
	4.13	RC-104	2.24	9.23	6.75	7.2
	6.13	RC-106*	2.24	13.70	9.75	9.8
	8.00	RC-108	2.24	17.89	11.75	12.0
	10.13	RC-1010*	2.24	22.65	13.75	14.0
	12.00	RC-1012	2.24	26.84	15.75	15.0
	14.00	RC-1014	2.24	31.31	17.75	18.0
15 (15.7)	1.00	RC-151	3.14	3.14	4.88	7.2
	2.00	RC-152	3.14	6.28	5.88	9.0
	4.00	RC-154*	3.14	12.57	7.88	11.0
	6.00	RC-156*	3.14	18.85	10.69	15.0
	8.00	RC-158	3.14	25.13	12.69	18.0
	10.00	RC-1510	3.14	31.42	14.69	21.0
	12.00	RC-1512	3.14	37.70	16.69	24.0
	14.00	RC-1514	3.14	43.98	18.69	26.0
25 (25.8)	1.00	RC-251	5.16	5.16	5.50	13.0
	2.00	RC-252*	5.16	10.31	6.50	14.0
	4.00	RC-254*	5.16	20.63	8.50	18.0
	6.25	RC-256*	5.16	32.23	10.75	22.0
	8.25	RC-258	5.16	42.55	12.75	27.0
	10.25	RC-2510	5.16	52.86	14.75	31.0
	12.25	RC-2512	5.16	63.18	16.75	36.0
	14.25	RC-2514*	5.16	73.49	18.75	39.0
30 (32.4)	8.25	RC-308	6.49	53.56	15.25	40.0
50 (55.2)	2.00	RC-502	11.04	22.09	6.94	33.0
	4.00	RC-504	11.04	44.18	8.94	42.0
	6.25	RC-506*	11.04	69.03	11.13	51.0
	13.25	RC-5013	11.04	146.34	18.13	83.0
75 (79.5)	6.13	RC-756	15.90	97.41	11.25	65.0
	13.13	RC-7513	15.90	208.74	19.38	130.0
100 (103.1)	6.63	RC-1006	20.63	136.67	14.06	130.0
	10.25	RC-10010	20.63	211.45	17.69	160.0

* Available as a set. See note on this page.

** RC-50 cylinder has non-removable grooved saddle and no collar thread.

RC Series



Capacity:

5-100 tons

Stroke:

.63-14.25 inches

Maximum Operating Pressure:

10,000 psi



Think Safety

Manufacturer's rating of load and stroke are maximum safe limits.

Good practice encourages using only 80% of these ratings!

Page: 274



RAC-Series, Single-Acting Cylinders

The lightweight general purpose spring return aluminum cylinders.

Page: 12



RC-Series DUO Cylinders

maintain external dimensions for use with existing fixtures.



Gauges

Minimize the risk of overloading and ensure long, dependable service from your equipment. Refer to

the System Components section for a full range of gauges.

Page: 117

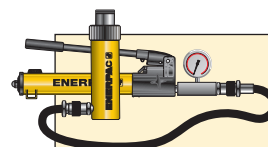

Pump and Cylinder Sets

All cylinders marked with an * are available as sets (cylinder, gauge, couplers, hose and pump) for your ordering convenience.

Page: 52

RC-Series DUO Cylinders, Single-Acting



Speed Chart

See the Enerpac Cylinder Speed Chart in our "Yellow Pages" to determine your approximate cylinder speed.

Page: **283**

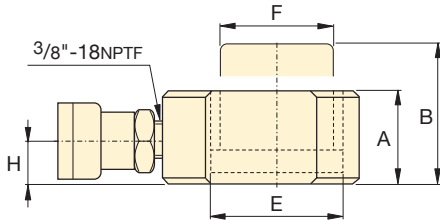
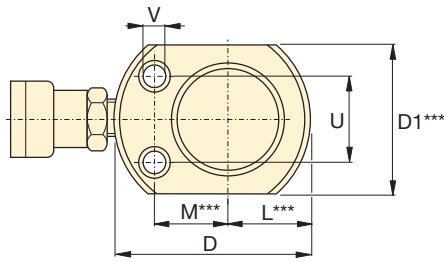

RC-50

RC-101 only
(U1 = .75 inch)

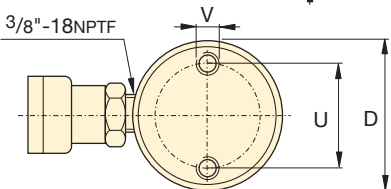
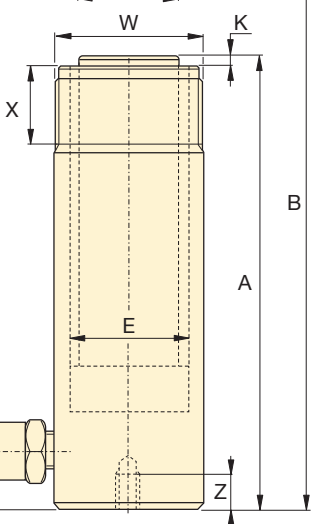
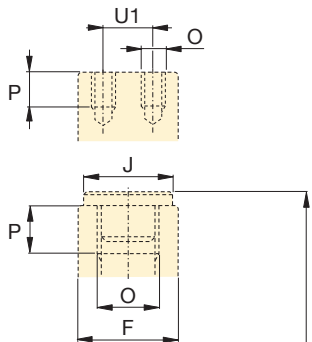

RC-51 to RC-5013 models

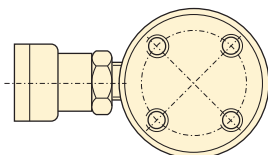

RC-1006 and RC-10010 models

◀ For full features see page 6.

Cylinder Capacity	Stroke	Model Number	Cylinder Effective Area	Oil Capacity	Collapsed Height	Extended Height	Outside Diameter
tons (maximum)	(in)		(in ²)	(in ³)	A (in)	B (in)	D (in)
5 (4.9)	.63	RC-50**	.99	.62	1.63	2.25	2.31
	1.00	RC-51	.99	.99	4.34	5.34	1.50
	3.00	RC-53	.99	2.98	6.50	9.50	1.50
	5.00	RC-55*	.99	4.97	8.50	13.50	1.50
	7.00	RC-57	.99	6.96	10.75	17.75	1.50
9.13	RC-59	.99	9.07	12.75	21.88	1.50	
10 (11.2)	1.00	RC-101	2.24	2.24	3.53	4.53	2.25
	2.13	RC-102*	2.24	4.75	4.78	6.91	2.25
	4.13	RC-104	2.24	9.23	6.75	10.88	2.25
	6.13	RC-106*	2.24	13.70	9.75	15.88	2.25
	8.00	RC-108	2.24	17.89	11.75	19.75	2.25
	10.13	RC-1010*	2.24	22.65	13.75	23.88	2.25
	14.00	RC-1014	2.24	31.31	17.75	31.75	2.25
15 (15.7)	1.00	RC-151	3.14	3.14	4.88	5.88	2.75
	2.00	RC-152	3.14	6.28	5.88	7.88	2.75
	4.00	RC-154*	3.14	12.57	7.88	11.88	2.75
	6.00	RC-156*	3.14	18.85	10.69	16.69	2.75
	8.00	RC-158	3.14	25.13	12.69	20.69	2.75
	10.00	RC-1510	3.14	31.42	14.69	24.69	2.75
	12.00	RC-1512	3.14	37.70	16.69	28.69	2.75
	14.00	RC-1514	3.14	43.98	18.69	32.69	2.75
25 (25.8)	1.00	RC-251	5.16	5.16	5.50	6.50	3.38
	2.00	RC-252*	5.16	10.31	6.50	8.50	3.38
	4.00	RC-254*	5.16	20.63	8.50	12.50	3.38
	6.25	RC-256*	5.16	32.23	10.75	17.00	3.38
	8.25	RC-258	5.16	42.55	12.75	21.00	3.38
	10.25	RC-2510	5.16	52.86	14.75	25.00	3.38
	12.25	RC-2512	5.16	63.18	16.75	29.00	3.38
14.25	RC-2514*	5.16	73.49	18.75	33.00	3.38	
30 (32.4)	8.25	RC-308	6.51	53.56	15.25	23.50	4.00
50 (55.2)	2.00	RC-502	11.04	22.09	6.94	8.94	5.00
	4.00	RC-504	11.04	44.18	8.94	12.94	5.00
	6.25	RC-506*	11.04	69.03	11.13	17.38	5.00
	13.25	RC-5013	11.04	146.34	18.13	31.38	5.00
75 (79.5)	6.13	RC-756	15.90	97.41	11.25	17.38	5.75
	13.13	RC-7513	15.90	208.74	19.38	32.50	5.75
100 (103.1)	6.63	RC-1006	20.63	136.67	14.06	20.69	7.00
	10.25	RC-10010	20.63	211.45	17.69	27.94	7.00

* Available as a set. See page 52.

** RC-50 cylinder has non-removable grooved saddle and no collar thread.

*** D1 = 1.63 inch, L = .81 inch, M = 1.00 inch.

Single-Acting, General Purpose Cylinders

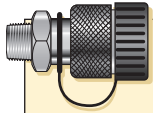

Couplers Included!
CR-400 couplers included on all models. Fits all HC-Series hoses.

Capacity:
5-100 tons

Stroke:
.63-14.25 inches

Maximum Operating Pressure:
10,000 psi

RC Series



Cylinder Bore Diam.	Plunger Diam.	Base to Adv. Port	Saddle Diam.	Saddle Protrusion from Plngr.	Plunger Internal Thread	Plunger Thread Length	Base Mounting Holes			Collar Thread	Collar Thread Length	Weight (lbs)	Model Number
							Bolt Circle U (in)	Thread V (in)	Thread Depth Z (in)				
E (in)	F (in)	H (in)	J (in)	K (in)	O (in)	P (in)	U (in)	V (in)	Z (in)	W (in)	X (in)	(lbs)	
1.13	1.00	.75	**	**	**	**	1.13	.22	—	—	—	2.2	RC-50**
1.13	1.00	.75	1.00	.25	3/4"-16	.56	1.00	1/4"-20UN	.56	1 1/2"-16	1.13	2.3	RC-51
1.13	1.00	.75	1.00	.25	3/4"-16	.56	1.00	1/4"-20UN	.56	1 1/2"-16	1.13	3.3	RC-53
1.13	1.00	.75	1.00	.25	3/4"-16	.56	1.00	1/4"-20UN	.56	1 1/2"-16	1.13	4.1	RC-55*
1.13	1.00	.75	1.00	.25	3/4"-16	.63	1.00	1/4"-20UN	.56	1 1/2"-16	1.13	5.3	RC-57
1.13	1.00	.75	1.00	.25	3/4"-16	.63	1.00	1/4"-20UN	.56	1 1/2"-16	1.13	6.1	RC-59
1.69	1.50	.75	—	—	#10-24UN	.25	1.56	5/16"-18UN	.50	2 1/4"-14	1.06	4.0	RC-101
1.69	1.50	.75	1.38	.25	1"-8	.75	1.56	5/16"-18UN	.50	2 1/4"-14	1.13	5.1	RC-102*
1.69	1.50	.75	1.38	.25	1"-8	.75	1.56	5/16"-18UN	.50	2 1/4"-14	1.06	7.2	RC-104
1.69	1.50	.75	1.38	.25	1"-8	.75	1.56	5/16"-18UN	.50	2 1/4"-14	1.13	9.8	RC-106*
1.69	1.50	.75	1.38	.25	1"-8	.75	1.56	5/16"-18UN	.50	2 1/4"-14	1.06	12	RC-108
1.69	1.50	.75	1.38	.25	1"-8	.75	1.56	5/16"-18UN	.50	2 1/4"-14	1.13	14	RC-1010*
1.69	1.50	.75	1.38	.25	1"-8	.75	1.56	5/16"-18UN	.50	2 1/4"-14	1.06	15	RC-1012
1.69	1.50	.75	1.38	.25	1"-8	.75	1.56	5/16"-18UN	.50	2 1/4"-14	1.06	18	RC-1014
2.00	1.63	.75	1.50	.38	1"-8	1.00	1.88	3/8"-16UN	.50	2 3/4"-16	1.19	7.2	RC-151
2.00	1.63	.75	1.50	.38	1"-8	1.00	1.88	3/8"-16UN	.50	2 3/4"-16	1.19	9	RC-152
2.00	1.63	.75	1.50	.38	1"-8	1.00	1.88	3/8"-16UN	.50	2 3/4"-16	1.19	11	RC-154*
2.00	1.63	1.00	1.50	.38	1"-8	1.00	1.88	3/8"-16UN	.50	2 3/4"-16	1.19	15	RC-156*
2.00	1.63	1.00	1.50	.38	1"-8	1.00	1.88	3/8"-16UN	.50	2 3/4"-16	1.19	18	RC-158
2.00	1.63	1.00	1.50	.38	1"-8	1.00	1.88	3/8"-16UN	.50	2 3/4"-16	1.19	21	RC-1510
2.00	1.63	1.00	1.50	.38	1"-8	1.00	1.88	3/8"-16UN	.50	2 3/4"-16	1.19	24	RC-1512
2.00	1.63	1.00	1.50	.38	1"-8	1.00	1.88	3/8"-16UN	.50	2 3/4"-16	1.19	26	RC-1514
2.56	2.25	1.00	2.00	.41	1 1/2"-16	1.00	2.31	1/2"-13UN	.75	3-12	1.94	13	RC-251
2.56	2.25	1.00	2.00	.41	1 1/2"-16	1.00	2.31	1/2"-13UN	.75	3 5/16"-12	1.94	14	RC-252*
2.56	2.25	1.00	2.00	.41	1 1/2"-16	1.00	2.31	1/2"-13UN	.75	3 5/16"-12	1.94	18	RC-254*
2.56	2.25	1.00	2.00	.41	1 1/2"-16	1.00	2.31	1/2"-13UN	.75	3 5/16"-12	1.94	22	RC-256*
2.56	2.25	1.00	2.00	.41	1 1/2"-16	1.00	2.31	1/2"-13UN	.75	3 5/16"-12	1.94	27	RC-258
2.56	2.25	1.00	2.00	.41	1 1/2"-16	1.00	2.31	1/2"-13UN	.75	3 5/16"-12	1.94	31	RC-2510
2.56	2.25	1.00	2.00	.41	1 1/2"-16	1.00	2.31	1/2"-13UN	.75	3 5/16"-12	1.94	36	RC-2512
2.56	2.25	1.00	2.00	.41	1 1/2"-16	1.00	2.31	1/2"-13UN	.75	3 5/16"-12	1.94	39	RC-2514*
2.88	2.25	2.25	2.00	.41	1 1/2"-16	1.00	—	—	—	3 5/16"-12	1.94	40	RC-308
3.75	3.13	1.31	2.81	.11	—	—	3.75	1/2"-13UN	.75	5"-12	2.19	33	RC-502
3.75	3.13	1.31	2.81	.11	—	—	3.75	1/2"-13UN	.75	5"-12	2.19	42	RC-504
3.75	3.13	1.38	2.81	.11	—	—	3.75	1/2"-13UN	.75	5"-12	2.19	51	RC-506*
3.75	3.13	1.38	2.81	.11	—	—	3.75	1/2"-13UN	.75	5"-12	2.19	83	RC-5013
4.50	3.75	1.19	2.81	.23	—	—	—	—	—	5 3/4"-12	1.75	65	RC-756
4.50	3.75	1.19	2.81	.23	—	—	—	—	—	5 3/4"-12	1.75	130	RC-7513
5.13	4.13	1.63	2.81	.11	—	—	5.50	3/4"-10UN	1.00	6 7/8"-12	1.75	130	RC-1006
5.13	4.13	1.63	2.81	.11	—	—	5.50	3/4"-10UN	1.00	6 7/8"-12	1.75	160	RC-10010

▼ SELECTION CHART

For Use with Cylinder Capacity (tons)	Saddles			Base Plate	Mounting Block	Clevis Eyes	
	Flat	Grooved ¹⁾	Tilt			Base ⁴⁾	Plunger
5	A-53F ²⁾	A-53G ²⁾	-	-	RB-5 ²⁾ , AW-51 ²⁾ , AW-53 ²⁾	REB-5 ²⁾	REP-5 ²⁾
10	A-12 ³⁾ , A-102F ³⁾	A-102G ³⁾	CAT-10 ³⁾	JBI-10	RB-10, AW-102	REB-10	REP-10 ³⁾
15	-	A-152G	CAT-10	-	RB-15	REB-15	REP-10
25	A-29	A-252G	CAT-50	JBI-25	RB-25	REB-25	REP-25
30	A-29	A-252G	CAT-50	-	RB-25	-	REP-25
50	-	-	CAT-100	JBI-50	-	-	-
75	-	-	CAT-100	-	-	-	-
100	-	-	CAT-100	-	-	-	-

¹⁾ Standard on 5-30 ton RC-cylinders ²⁾ Except RC-50 ³⁾ Except RC-101 ⁴⁾ Mounting screws are included.

▼ DIMENSION CHARTS

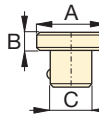
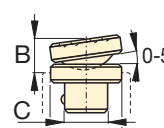
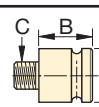
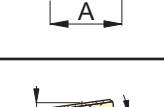
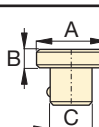
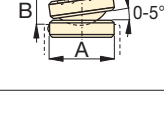
Model Number	Saddle Dimensions (in)				Model Number	Tilt Saddle Dimensions (in)			
	A	B	C			A	B	C	
Flat					Tilt				
A-53F	1.00	.25	.68		CAT-10	1.38	.79	.88	
A-102F	1.38	.24	.88		CAT-50	1.97	.83	1.40	
A-12	2.00	1.88	1" - 8UNC						
A-29	2.00	1.88	1 1/2" - 16UN						
Grooved					Tilt				
A-53G	1.00	.25	.68		CAT-100	2.80	.98	-	
A-102G	1.38	.24	.88						
A-152G	1.50	.37	.88						
A-252G	1.97	.37	1.40						

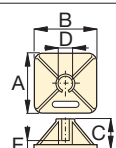
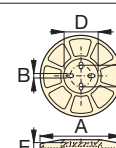
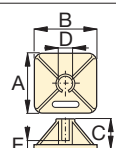
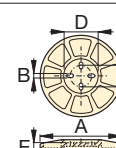
Model Number	Base Plate Dimensions (in)						
	A	B	C	D	E		
JBI-10	9.00	9.00	5.34	2.29	.81		
JBI-25	11.00	11.00	5.53	3.41	1.03		
JBI-50	12.00	.60	3.75	5.19	1.25		

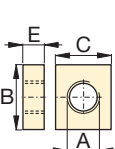
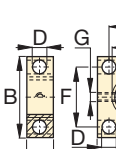
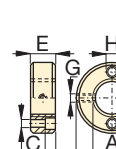
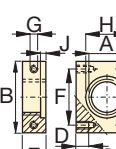
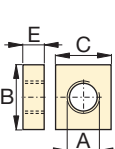
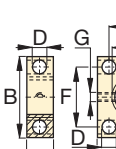
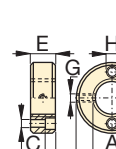
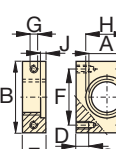
Model Number	Mounting Block Dimensions (in)											
	A	B	C	D	E	F	G	H				
RB-5	1 1/2" - 16	3.50	3.00	-	1.00	-	-	-				
AW-51	1 1/2" - 16	2.76	2.36	.43	.98	2.13	1/4" - 20	1.62				
AW-53	1 1/2" - 16	2.87	.28	.31	.75	2.25	1/4" - 20	.41				
RB-10	2 1/4" - 14	4.50	3.50	-	1.00	-	-	-				
AW-102	2 1/4" - 14	3.94	3.25	.63	1.18	3.00	7/16" - 20	2.31				
RB-15	2 3/4" - 16	4.00	4.50	-	1.50	-	-	-				
RB-25	3 5/16" - 12	5.00	6.50	-	2.00	-	-	-				

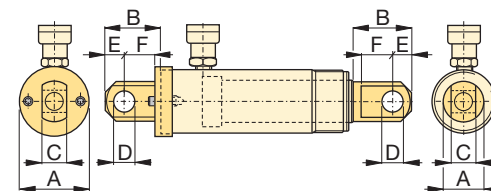
Type	Model Number	Clevis Eye Dimensions (in)						Pin to Pin* (in)	
		A	B	C	D	E	F		
Base ⁴⁾	REB-5	1.75	1.88	.56	.63	.63	1.00	2.37	
	REB-10	2.50	2.63	1.00	.88	1.00	1.38	3.07	
	REB-15	3.00	2.63	1.00	.88	1.00	1.38	3.07	
	REB-25	3.75	3.13	1.50	1.25	1.25	1.63	3.45	
Plunger	REP-5	1.13	1.75	.56	.63	.63	.75	-	
	REP-10	1.69	2.43	1.00	.88	1.00	1.13	-	
	REP-25	2.25	2.81	1.50	1.25	1.25	1.38	-	

* Pin to Pin- REB and REP Clevises fitted. Add cylinder collapsed height.

⁴⁾ Mounting screws are included.

The Enerpac Lightweight Aluminum Cylinders

▼ Shown: RAC, RACL, RACH, and RAR



- Lightweight, easy to carry and position to allow a higher cylinder capacity-to-weight-ratio
- Non-corrosive by design, aluminum has always been a good material for use in many caustic environments
- Composite bearings on all moving surfaces guarantee NO metal-to-metal contact, to resist side loads and increase cylinder life

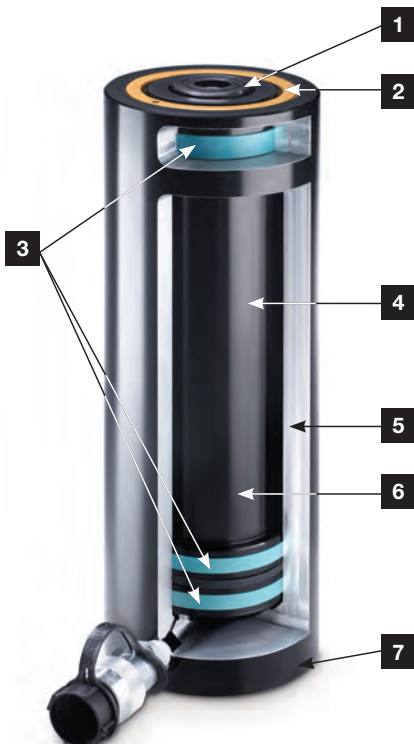

1. **Removable Hardened Saddle** protects plunger from being damaged by abrasive surface contact.
2. **Stop Ring** on all models absorbs eccentric loading and prevents plunger over-extension.
3. **Composite Bearing** material to prevent metal-to-metal contact, reducing side-load issues and increasing life.
4. **Hard-coated Plunger and Base** resist wear and prevent galling.
5. **7075-T6 Aluminum Alloy Components** for maximum strength and minimum weight.
6. **Plunger Return Spring** on all single-acting models for prompt cylinder return.
7. **Standard Steel Base Plate** protects cylinder base from abrasive surfaces.

RA Series

Capacity:

20-150 tons

Stroke:

1.97-9.84 inches

Maximum Operating Pressure:

10,000 psi



Think Safety

Manufacturer's rating of load and stroke are maximum safe limits.

Good practice encourages using only 80% of these ratings!

Page: 274



Aluminum vs. Steel

Aluminum cylinders, while offering the most lightweight solution also have some unique limitations due to material properties. It differs from steel in that it has a lower finite fatigue life. Aluminum cylinders should NOT be used in high-cycle applications such as production.

These cylinders are designed to provide 5000 cycles at their recommended pressure. **This limit should not be exceeded.** In normal lifting and many maintenance applications, this should provide a lifetime of use.

▼ Shown from left to right: RAC-508, RAC-1506, RAC-304, and RAC-206



Lightweight for Maximum Portability



Saddles

All RAC cylinders are equipped with bolt-on removable saddles of hardened steel.



Lightweight Hand Pumps

Enerpac hand pumps **P-392** or **P-802** make the optimal lightweight set.

Page: **70**

- Composite bearings prevent metal-to-metal contact, increasing cylinder life and resistance to side-loads of up to 10%
- Hard coat finish on all surfaces resists damage and extends cylinder life
- Handles included on all models
- Steel baseplate and saddle for protection against load-induced damage
- Integral stop ring prevents plunger over-travel and is capable of withstanding the full cylinder capacity
- High-strength return spring for rapid cylinder retraction
- CR-400 coupler and dust cap included on all models
- All cylinders meet ASME B-30.1 and ISO 10100 standards

Cylinder Capacity tons (maximum)	Stroke* (in)	Model Number	Cylinder Effective Area (in ²)
20 (24.2)	1.97	RAC-202	4.83
	3.94	RAC-204	4.83
	5.91	RAC-206	4.83
	7.87	RAC-208	4.83
	9.84	RAC-2010	4.83
30 (34.2)	1.97	RAC-302	6.85
	3.94	RAC-304	6.85
	5.91	RAC-306	6.85
	7.87	RAC-308	6.85
	9.84	RAC-3010	6.85
50 (54.9)	1.97	RAC-502	10.99
	3.94	RAC-504	10.99
	5.91	RAC-506	10.99
	7.87	RAC-508	10.99
	9.84	RAC-5010	10.99
100 (110.9)	1.97	RAC-1002	22.19
	3.94	RAC-1004	22.19
	5.91	RAC-1006	22.19
	7.87	RAC-1008	22.19
	9.84	RAC-10010	22.19
150 (175.9)	1.97	RAC-1502	35.18
	3.94	RAC-1504	35.18
	5.91	RAC-1506	35.18
	7.87	RAC-1508	35.18
	9.84	RAC-15010	35.18

* Custom strokes available.



◀ Enerpac lightweight aluminum RAC-506 cylinders are ideal for wet environments such as this tunnel under the river (Holland High-Speed Train Line).

Single-Acting, Spring Return Cylinders



Steel Base Plate

The steel base plate protects the cylinder base from damage, it should not be removed.

The base holes in these aluminum cylinders are designed for securing the steel base plate. **They will not withstand the capacity of the cylinder.**

Do not use the base holes in these aluminum cylinders to attach any device to the cylinder.

Capacity:
20-150 tons

Stroke:
1.97-9.84 inches

Maximum Operating Pressure:
10,000 psi

RAC Series



Optional Bolt-on Tilt Saddle Dimensions (in)

Cylinder Model / Capacity (ton)	Model Number*	Saddle Diameter J1	Saddle Protrusion from Plunger K1
RAC-50	CATG-50	1.95	1.02
RAC-100	CATG-150	3.57	1.30
RAC-150	CATG-200	4.64	1.44

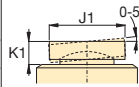

* Tilt saddle not available for less than 50 ton.

Steel Base Plate Mounting Holes

Cylinder Model / Capacity (ton)	Bolt Circle U (in)	Thread V (mm)	Thread Depth ¹⁾ Z (in)
RAC-20	2.76	M6	.47
RAC-30	3.15	M6	.47
RAC-50	4.33	M6	.47
RAC-100	5.91	M10	.47
RAC-150	7.87	M10	.47

¹⁾ Including Base Plate Height of .25 inches. Four (4) base plate bolts included.

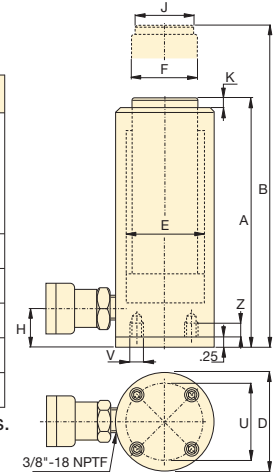

Oil Capacity (in ³)	Collapsed Height		Extended Height (in)	Outside Diameter (in)	Cylinder Bore Diameter (in)	Plunger Diameter (in)	Base to Advance Port (in)	Saddle Diameter (in)	Saddle Protrusion from Plunger (in)	Weight (lbs)	Model Number
	A (in)	B (in)									
9.52	6.85	8.83	3.35	2.48	1.97	1.07	1.58	0.12	7.9	RAC-202	
19.03	8.82	12.76	3.35	2.48	1.97	1.07	1.58	0.12	9.0	RAC-204	
28.55	10.79	16.70	3.35	2.48	1.97	1.07	1.58	0.12	10.1	RAC-206	
38.01	12.76	20.64	3.35	2.48	1.97	1.07	1.58	0.12	11.2	RAC-208	
47.53	14.73	24.58	3.35	2.48	1.97	1.07	1.58	0.12	12.3	RAC-2010	
13.49	7.13	9.10	3.94	2.95	2.36	1.31	1.58	0.12	9.9	RAC-302	
26.99	9.09	13.04	3.94	2.95	2.36	1.31	1.58	0.12	11.5	RAC-304	
40.48	11.06	16.98	3.94	2.95	2.36	1.31	1.58	0.12	13.0	RAC-306	
53.91	13.04	20.91	3.94	2.95	2.36	1.31	1.58	0.12	14.5	RAC-308	
67.40	15.01	24.85	3.94	2.95	2.36	1.31	1.58	0.12	16.1	RAC-3010	
21.65	7.32	9.90	5.12	3.74	3.15	1.19	1.97	0.12	18.7	RAC-502	
43.30	9.29	13.24	5.12	3.74	3.15	1.19	1.97	0.12	21.6	RAC-504	
64.95	11.26	17.17	5.12	3.74	3.15	1.19	1.97	0.12	24.5	RAC-506	
86.49	13.24	21.11	5.12	3.74	3.15	1.19	1.97	0.12	27.3	RAC-508	
108.14	15.21	25.05	5.12	3.74	3.15	1.19	1.97	0.12	30.2	RAC-5010	
43.71	8.71	10.68	7.09	5.32	4.33	1.82	3.70	0.12	38.1	RAC-1002	
87.43	10.67	14.61	7.09	5.32	4.33	1.82	3.70	0.12	43.2	RAC-1004	
131.14	12.64	18.55	7.09	5.32	4.33	1.82	3.70	0.12	48.3	RAC-1006	
174.64	14.61	22.49	7.09	5.32	4.33	1.82	3.70	0.12	53.4	RAC-1008	
218.35	16.58	26.43	7.09	5.32	4.33	1.82	3.70	0.12	58.4	RAC-10010	
69.30	9.56	11.53	9.06	6.69	5.51	2.02	4.45	0.12	55.8	RAC-1502	
138.61	11.53	15.47	9.06	6.69	5.51	2.02	4.45	0.12	64.6	RAC-1504	
207.91	13.49	19.41	9.06	6.69	5.51	2.02	4.45	0.12	73.4	RAC-1506	
276.87	15.47	23.34	9.06	6.69	5.51	2.02	4.45	0.12	82.2	RAC-1508	
346.17	17.44	27.28	9.06	6.69	5.51	2.02	4.45	0.12	91.1	RAC-15010	

▼ Shown from left to right: RACL-1006, RACL-504 and RACL-506



To Secure Loads Mechanically



Saddles

All RACL cylinders are equipped with bolt-on removable saddles of hardened steel. For tilt saddles see next page.

Page: 15



Hoses

Enerpac offers a complete line of high-quality hydraulic hoses. To ensure the integrity of your system, specify only Enerpac hydraulic hoses.

Page: 132

- Aluminum Lock Nut provides mechanical load holding for extended periods
- Hardened steel stop ring increases cylinder life and resistance to side-loads of up to 5%
- Hard coat finish on all surfaces resists damage and extends cylinder life
- Composite bearings increase cylinder life and side load resistance
- Handles included on all models
- Steel base plate and saddle for protection against load-induced damage
- Integral stop ring prevents plunger over-travel and is capable of withstanding the full cylinder capacity
- High-strength return spring for rapid cylinder retraction
- CR-400 coupler and dust cap included on all models
- All cylinders meet ASME B-30.1 and ISO 10100 standards



◀ The portable Lock Nut cylinder RACL-1506 used for extended load support during epoxy injection for bridge reinforcement.

Cylinder Capacity	Stroke*	Model Number	Cylinder Effective Area
ton (maximum)	(in)		(in ²)
20 (24.2)	1.97	RACL-202	4.83
	3.94	RACL-204	4.83
	5.91	RACL-206	4.83
	7.87	RACL-208	4.83
	9.84	RACL-2010	4.83
30 (34.2)	1.97	RACL-302	6.85
	3.94	RACL-304	6.85
	5.91	RACL-306	6.85
	7.87	RACL-308	6.85
	9.84	RACL-3010	6.85
50 (54.9)	1.97	RACL-502	10.99
	3.94	RACL-504	10.99
	5.91	RACL-506	10.99
	7.87	RACL-508	10.99
	9.84	RACL-5010	10.99
100 (110.9)	1.97	RACL-1002	22.19
	3.94	RACL-1004	22.19
	5.91	RACL-1006	22.19
	7.87	RACL-1008	22.19
	9.84	RACL-10010	22.19
150 (175.9)	1.97	RACL-1502	35.18
	3.94	RACL-1504	35.18
	5.91	RACL-1506	35.18
	7.87	RACL-1508	35.18
	9.84	RACL-15010	35.18

* Custom strokes available.

Single-Acting, Spring Return, Lock Nut Cylinders



Steel Base Plate

The steel base plate protects the cylinder base from damage, it should not be removed.

The base holes in these aluminum cylinders are designed for securing the steel base plate. **They will not withstand the capacity of the cylinder.**

Do not use the base holes in these aluminum cylinders to attach any device to the cylinder.

Capacity:
20-150 tons

Stroke:
1.97-9.84 inches

Maximum Operating Pressure:
10,000 psi

RACL Series



Optional Bolt-on Tilt Saddle Dimensions (in)

Cylinder Model / Capacity (ton)	Model Number*	Saddle Diameter	Saddle Protrusion from Plunger K1
		J1	
RACL-50	CATG-50	1.95	1.02
RACL-100	CATG-150	3.57	1.30
RACL-150	CATG-200	4.64	1.44

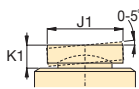

* Tilt saddle not available for less than 50 ton.

Steel Base Plate Mounting Holes

Cylinder Model / Capacity (ton)	Bolt Circle U (in)	Thread V (mm)	Thread Depth ¹⁾ Z (in)
RACL-20	2.76	M6	.47
RACL-30	3.15	M6	.47
RACL-50	4.33	M6	.47
RACL-100	5.91	M10	.47
RACL-150	7.87	M10	.47

¹⁾ Including Base Plate Height of .25 inches. Four (4) base plate bolts included.

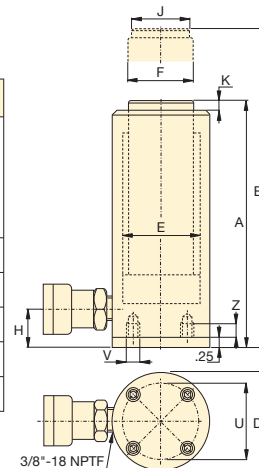

Oil Capacity	Collapsed Height	Extended Height	Outside Diameter	Cylinder Bore Diameter	Plunger Diameter (Threaded)	Base to Advance Port	Saddle Diameter	Saddle Protrusion from Plunger	Lock Nut Height	Weight	Model Number
(in ³)	A (in)	B (in)	D (in)	E (in)	F (in)	H (in)	J (in)	K (in)	S (in)	(lbs)	
9.52	8.83	10.80	3.35	2.48	2.17	1.07	1.58	0.12	1.97	8.8	RACL-202
19.03	10.80	14.73	3.35	2.48	2.17	1.07	1.58	0.12	1.97	10.1	RACL-204
28.55	12.76	18.67	3.35	2.48	2.17	1.07	1.58	0.12	1.97	11.4	RACL-206
38.01	14.73	22.61	3.35	2.48	2.17	1.07	1.58	0.12	1.97	12.7	RACL-208
47.53	16.70	26.54	3.35	2.48	2.17	1.07	1.58	0.12	1.97	14.1	RACL-2010
13.49	9.10	11.07	3.94	2.95	2.36	1.31	1.58	0.12	1.97	11.9	RACL-302
26.99	11.07	15.01	3.94	2.95	2.36	1.31	1.58	0.12	1.97	13.4	RACL-304
40.48	13.04	18.95	3.94	2.95	2.36	1.31	1.58	0.12	1.97	14.9	RACL-306
53.91	15.01	22.88	3.94	2.95	2.36	1.31	1.58	0.12	1.97	16.5	RACL-308
67.40	16.98	26.82	3.94	2.95	2.36	1.31	1.58	0.12	1.97	18.0	RACL-3010
21.65	9.29	11.27	5.12	3.74	3.15	1.19	1.97	0.12	2.95	20.5	RACL-502
43.30	11.26	15.21	5.12	3.74	3.15	1.19	1.97	0.12	2.95	23.4	RACL-504
64.95	13.23	19.14	5.12	3.74	3.15	1.19	1.97	0.12	2.95	26.2	RACL-506
86.49	15.20	23.08	5.12	3.74	3.15	1.19	1.97	0.12	2.95	29.1	RACL-508
108.14	17.17	27.02	5.12	3.74	3.15	1.19	1.97	0.12	2.95	31.9	RACL-5010
43.71	11.65	13.63	7.09	5.32	4.33	1.82	3.70	0.12	2.95	48.2	RACL-1002
87.43	13.62	17.57	7.09	5.32	4.33	1.82	3.70	0.12	2.95	53.3	RACL-1004
131.14	15.59	21.50	7.09	5.32	4.33	1.82	3.70	0.12	2.95	58.4	RACL-1006
174.64	17.57	25.44	7.09	5.32	4.33	1.82	3.70	0.12	2.95	63.4	RACL-1008
218.35	19.54	29.38	7.09	5.32	4.33	1.82	3.70	0.12	2.95	68.5	RACL-10010
69.30	12.72	14.68	9.06	6.69	5.51	2.02	4.45	0.12	3.15	71.0	RACL-1502
138.61	14.69	18.62	9.06	6.69	5.51	2.02	4.45	0.12	3.15	79.8	RACL-1504
207.91	16.65	22.56	9.06	6.69	5.51	2.02	4.45	0.12	3.15	88.6	RACL-1506
276.87	18.62	26.49	9.06	6.69	5.51	2.02	4.45	0.12	3.15	97.4	RACL-1508
346.17	20.59	30.43	9.06	6.69	5.51	2.02	4.45	0.12	3.15	106.3	RACL-15010

▼ Shown from left to right: RACH-1508, RACH-304 and RACH-208



The Lightweight Solution for Tensioning and Testing



Saddles

All RACH-cylinders are equipped with bolt-on removable hardened steel hollow saddles.



Lightweight Hand Pumps

Enerpac hand pumps **P-392** or **P-802** make the optimal lightweight set.

Page: 70

- Hollow plunger design allows for both pull and push forces
- Composite bearings increase cylinder life and side load resistance
- Hard coat finish on all surfaces resists damage and extends cylinder life
- Handles included on all models
- Floating center tube increases seal life
- Steel baseplate and saddle for protection against load-induced damage
- Integral stop ring prevents plunger over-travel and is capable of withstanding the full cylinder capacity
- High-strength return spring for rapid cylinder retraction
- CR-400 coupler and dust cap included on all models
- All cylinders meet ASME B-30.1 and ISO 10100 standards

Cylinder Capacity	Stroke*	Model Number	Cylinder Effective Area
tons (maximum)	(in)		(in ²)
20 (25.4)	1.97	RACH-202	5.07
	3.94	RACH-204	5.07
	5.91	RACH-206	5.07
	7.87	RACH-208	5.07
	9.84	RACH-2010	5.07
30 (39.6)	1.97	RACH-302	7.92
	3.94	RACH-304	7.92
	5.91	RACH-306	7.92
	7.87	RACH-308	7.92
	9.84	RACH-3010	7.92
60 (65.6)	1.97	RACH-602	13.13
	3.94	RACH-604	13.13
	5.91	RACH-606	13.13
	7.87	RACH-608	13.13
	9.84	RACH-6010	13.13
100 (127.5)	1.97	RACH-1002	25.51
	3.94	RACH-1004	25.51
	5.91	RACH-1006	25.51
	7.87	RACH-1008	25.51
	9.84	RACH-10010	25.51
150 (175.0)	1.97	RACH-1502	35.00
	3.94	RACH-1504	35.00
	5.91	RACH-1506	35.00
	7.87	RACH-1508	35.00
	9.84	RACH-15010	35.00

* Custom strokes available.



◀ An RACH-306, powered by a P-392 hand pump, is used to extract corroded carriage pins from refuse collection vehicles.

Single-Acting, Spring Return, Hollow Plunger Cylinders



Steel Base Plate

The steel base plate protects the cylinder base from damage, it should not be removed.

The base holes in these aluminum cylinders are designed for securing the steel base plate. **They will not**

withstand the capacity of the cylinder.

Do not use the base holes in these aluminum cylinders to attach any device to the cylinder.

RACH Series



Capacity:

20-150 tons

Stroke:

1.97-9.84 inches

Center Hole Diameter:

1.06-3.11 inches

Maximum Operating Pressure:

10,000 psi

Steel Base Plate Mounting Holes

Cylinder Model / Capacity (ton)	Bolt Circle U (in)	Thread V (mm)	Thread Depth ¹⁾ Z (in)
RACH-20	3.15	M6	.47
RACH-30	4.33	M6	.47
RACH-60	6.30	M6	.47
RACH-100	8.66	M10	.47
RACH-150	9.65	M10	.47

¹⁾ Including Base Plate Height of .25 inches. Four (4) baseplate bolts included.

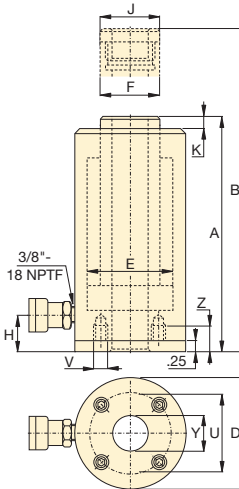

Oil Capacity (in ³)	Collapsed Height A (in)	Extended Height B (in)	Outside Diameter D (in)	Cylinder Bore Diameter E (in)	Plunger Diameter F (in)	Base to Advance Port H (in)	Saddle Diameter J (in)	Saddle Protrusion from Plunger K (in)	Center Hole Diameter Y (in)	Weight (lbs)	Model Number
9.98	7.41	9.38	3.93	2.95	2.17	1.14	2.17	0.40	1.06	11.5	RACH-202
19.96	9.89	13.83	3.93	2.95	2.17	1.14	2.17	0.40	1.06	13.5	RACH-204
29.94	12.41	18.32	3.93	2.95	2.17	1.14	2.17	0.40	1.06	15.6	RACH-206
39.87	14.89	22.76	3.93	2.95	2.17	1.14	2.17	0.40	1.06	17.7	RACH-208
49.90	17.41	27.25	3.93	2.95	2.17	1.14	2.17	0.40	1.06	19.8	RACH-210
15.59	8.20	10.17	5.12	3.74	2.76	1.14	2.76	0.40	1.34	17.6	RACH-302
31.18	10.52	14.46	5.12	3.74	2.76	1.14	2.76	0.40	1.34	20.9	RACH-304
46.77	13.12	19.02	5.12	3.74	2.76	1.14	2.76	0.40	1.34	24.6	RACH-306
62.35	15.56	23.43	5.12	3.74	2.76	1.14	2.76	0.40	1.34	28.4	RACH-308
77.94	18.04	27.88	5.12	3.74	2.76	1.14	2.76	0.40	1.34	31.9	RACH-3010
25.84	9.89	11.86	7.09	5.12	3.94	2.41	3.94	0.47	2.13	35.6	RACH-602
51.69	12.41	16.35	7.09	5.12	3.94	2.41	3.94	0.47	2.13	42.8	RACH-604
77.53	14.97	20.87	7.09	5.12	3.94	2.41	3.94	0.47	2.13	50.3	RACH-606
103.37	17.52	25.40	7.09	5.12	3.94	2.41	3.94	0.47	2.13	57.2	RACH-608
129.21	20.09	29.93	7.09	5.12	3.94	2.41	3.94	0.47	2.13	65.1	RACH-6010
50.21	10.16	12.13	9.84	7.28	5.71	2.41	5.71	0.55	3.11	74.6	RACH-1002
100.43	12.80	16.74	9.84	7.28	5.71	2.41	5.71	0.55	3.11	87.8	RACH-1004
150.64	15.40	21.31	9.84	7.28	5.71	2.41	5.71	0.55	3.11	101.9	RACH-1006
200.85	18.08	25.95	9.84	7.28	5.71	2.41	5.71	0.55	3.11	115.7	RACH-1008
251.07	20.76	30.60	9.84	7.28	5.71	2.41	5.71	0.55	3.11	129.3	RACH-10010
66.08	11.03	13.00	10.83	8.07	5.91	2.41	5.71	0.55	3.11	107.7	RACH-1502
132.17	14.18	18.12	10.83	8.07	5.91	2.41	5.71	0.55	3.11	122.8	RACH-1504
206.72	16.93	22.84	10.83	8.07	5.91	2.41	5.71	0.55	3.11	138.9	RACH-1506
275.62	19.69	27.57	10.83	8.07	5.91	2.41	5.71	0.55	3.11	154.5	RACH-1508
344.53	22.45	32.29	10.83	8.07	5.91	2.41	5.71	0.55	3.11	170.2	RACH-15010

▼ Shown from left to right: RAR-506, RAR-508, RAR-302



The Lightweight Solution for Double-Acting Applications



Saddles

All RAR-cylinders are equipped with bolt-on removable hardened steel saddles. For tilt saddles see next page.

Page: 19



Hoses

Enerpac offers a complete line of high-quality hydraulic hoses. To ensure the integrity of your system, specify only Enerpac hydraulic hoses.

Page: 132

- Double-acting for rapid retraction, regardless of hose lengths and system losses
- Composite bearings increase cylinder life and side load resistance
- Hard coat finish on all surfaces resists damage and extends cylinder life
- Handles included on all models
- Steel base plate and saddle for protection against load-induced damage
- Integral stop ring prevents plunger over-travel and is capable of withstanding the full cylinder capacity
- Built-in safety valve prevents accidental over-pressurization



◀ An RAR-506 was easy to position under a bulldozer for repair of frame member.

Cylinder Capacity (ton)	Stroke* (in)	Model Number	Maximum Cylinder Capacity (ton)		Cylinder Effective Area (in ²)		Oil Capacity (in ³)	
			Push	Pull	Push	Pull	Push	Pull
20 (24.2)	1.97	RAR-202	24.2	14.4	4.83	2.88	9.52	5.67
	3.94	RAR-204	24.2	14.4	4.83	2.88	19.03	11.34
	5.91	RAR-206	24.2	14.4	4.83	2.88	28.55	17.02
	7.87	RAR-208	24.2	14.4	4.83	2.88	38.01	22.66
	9.84	RAR-2010	24.2	14.4	4.83	2.88	47.53	28.34
30 (34.2)	1.97	RAR-302	34.2	19	6.85	3.80	13.49	7.49
	3.94	RAR-304	34.2	19	6.85	3.80	26.99	14.97
	5.91	RAR-306	34.2	19	6.85	3.80	40.48	22.46
	7.87	RAR-308	34.2	19	6.85	3.80	53.91	29.91
	9.84	RAR-3010	34.2	19	6.85	3.80	67.40	37.39
50 (54.9)	1.97	RAR-502	55	21	10.99	3.54	21.65	6.97
	3.94	RAR-504	55	21	10.99	3.54	43.30	13.95
	5.91	RAR-506	55	21	10.99	3.54	64.95	20.92
	7.87	RAR-508	55	21	10.99	3.54	86.49	27.86
	9.84	RAR-5010	55	21	10.99	3.54	108.14	34.83
100 (110.9)	1.97	RAR-1002	111	62	22.19	12.33	43.71	24.29
	3.94	RAR-1004	111	62	22.19	12.33	87.43	48.58
	5.91	RAR-1006	111	62	22.19	12.33	131.14	72.87
	7.87	RAR-1008	111	62	22.19	12.33	174.64	97.04
	9.84	RAR-10010	111	62	22.19	12.33	218.35	121.33
150 (175.9)	1.97	RAR-1502	176	102	35.18	20.45	69.30	40.29
	3.94	RAR-1504	176	102	35.18	20.45	138.61	80.57
	5.91	RAR-1506	176	102	35.18	20.45	207.91	120.86
	7.87	RAR-1508	176	102	35.18	20.45	276.87	160.94
	9.84	RAR-15010	176	102	35.18	20.45	346.17	201.23

* Custom strokes available.

Double-Acting, Aluminum Cylinders



Steel Base Plate

The steel base plate protects the cylinder base from damage, it should not be removed.

The base holes in these aluminum cylinders are designed for securing the steel base plate. **They will not withstand the capacity of the cylinder.**

Do not use the base holes in these aluminum cylinders to attach any device to the cylinder.

Capacity:
20-150 tons

Stroke:
1.97-9.84 inches

Maximum Operating Pressure:
10,000 psi

RAR Series



Optional Bolt Tilt Saddle Dimensions (in)

Cylinder Model / Capacity (ton)	Model Number*	Saddle Diameter J1	Saddle Protrusion from Plunger K1
RAR-50	CATG-50	1.95	1.02
RAR-100	CATG-100	2.81	1.22
RAR-150	CATG-150	3.57	1.30

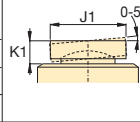

* Tilt saddle not available for less than 50 ton.

Steel Base Plate Mounting Holes

Cylinder Model / Capacity (ton)	Bolt Circle U (in)	Thread V (mm)	Thread Depth ¹⁾ Z (in)
RAR-20	3.66	M6	.47
RAR-30	4.13	M6	.47
RAR-50	4.33	M6	.47
RAR-100	6.10	M10	.47
RAR-150	7.87	M10	.47

¹⁾ Including Base Plate Height of .25 inches. Four (4) base plate bolts included.

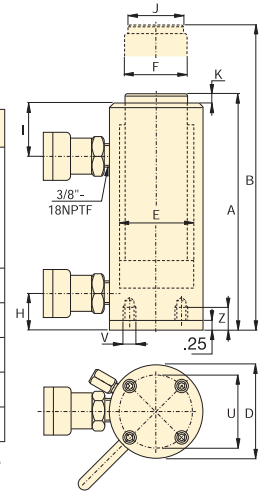

Collapsed Height	Extended Height	Outside Diameter	Cylinder Bore Diameter	Plunger Diameter	Base to Advance Port	Top to Retract Port	Saddle Diameter	Saddle Protrusion from Plunger	Weight	Model Number
A (in)	B (in)	D (in)	E (in)	F (in)	H (in)	I (in)	J (in)	K (in)	(lbs)	
7.45	9.42	4.45	2.48	1.58	1.19	1.97	1.18	0.12	16.3	RAR-202
9.42	13.35	4.45	2.48	1.58	1.19	1.97	1.18	0.12	17.6	RAR-204
11.29	17.29	4.45	2.48	1.58	1.19	1.97	1.18	0.12	19.0	RAR-206
13.35	21.23	4.45	2.48	1.58	1.19	1.97	1.18	0.12	20.3	RAR-208
15.32	25.17	4.45	2.48	1.58	1.19	1.97	1.18	0.12	21.6	RAR-2010
7.92	9.89	4.92	2.95	1.97	1.19	2.17	1.58	0.12	19.0	RAR-302
9.89	13.83	4.92	2.95	1.97	1.19	2.17	1.58	0.12	20.9	RAR-304
11.86	17.76	4.92	2.95	1.97	1.19	2.17	1.58	0.12	22.9	RAR-306
13.83	21.70	4.92	2.95	1.97	1.19	2.17	1.58	0.12	24.9	RAR-308
15.80	25.64	4.92	2.95	1.97	1.19	2.17	1.58	0.12	26.9	RAR-3010
7.92	9.89	5.71	3.74	2.95	1.19	2.21	1.97	0.12	24.5	RAR-502
9.89	13.83	5.71	3.74	2.95	1.19	2.21	1.97	0.12	28.0	RAR-504
11.86	17.76	5.71	3.74	2.95	1.19	2.21	1.97	0.12	31.5	RAR-506
13.83	21.70	5.71	3.74	2.95	1.19	2.21	1.97	0.12	35.1	RAR-508
15.80	25.64	5.71	3.74	2.95	1.19	2.21	1.97	0.12	38.6	RAR-5010
9.89	11.86	7.28	5.32	3.54	1.70	3.15	2.95	0.12	36.2	RAR-1002
11.86	15.80	7.28	5.32	3.54	1.70	3.15	2.95	0.12	42.6	RAR-1004
13.83	19.73	7.28	5.32	3.54	1.70	3.15	2.95	0.12	48.9	RAR-1006
15.80	23.67	7.28	5.32	3.54	1.70	3.15	2.95	0.12	55.3	RAR-1008
17.76	27.61	7.28	5.32	3.54	1.70	3.15	2.95	0.12	61.7	RAR-10010
9.77	11.74	9.06	6.70	4.33	1.50	2.95	3.70	0.12	53.4	RAR-1502
11.74	16.68	9.06	6.70	4.33	1.50	2.95	3.70	0.12	63.7	RAR-1504
13.71	19.61	9.06	6.70	4.33	1.50	2.95	3.70	0.12	73.2	RAR-1506
15.68	23.55	9.06	6.70	4.33	1.50	2.95	3.70	0.12	83.6	RAR-1508
19.61	29.46	9.06	6.70	4.33	1.50	2.95	3.70	0.12	93.9	RAR-15010

▼ LPL-Series, Low-height Lock Nut Cylinders



- Lock nut provides mechanical load holding for a safe work environment
- Integrated tilt saddle allows for up to 5 degrees of misalignment
- Extreme low-height for use in confined areas
- Side-load resistance 5-10% of maximum capacity
- Overflow port as stroke limiter to prevent plunger blow-out
- Single-acting, gravity-return

▼ Only the extreme low-height LPL-cylinder fits in this confined area to lift the construction. The lock nut provides positive and safe mechanical load holding over a long period of time.



The Lowest Power Lifter



Integrated Tilt Saddles

All LPL-Series cylinders include integral tilt saddles with maximum tilt angles up to 5°.



The Summit Edition

Innovation is at the heart of the new Summit Edition cylinders, delivering the high-quality construction that you expect from Enerpac. Their durability ensures your job is done safely and reliably.

- Replaceable plunger support bearing adds support for eccentric loads *
- Nitrocarburization surface treatment for improved load and wear resistance and corrosion protection
- Replaceable composite bearing surrounds the seal, providing support for eccentric loads
- Low-wear, high-pressure seals provide longer service life.

* Eccentric load (or “side-load”) is inevitable in heavy lifting. Enerpac's unique *Summit Edition* features provide the ultimate protection against side load. Increased bearing surface maintains stability, and nitrocarburization treatment prevents scoring on the inside of the cylinder. Side-load poses a real problem.... our new cylinder features are the solution!

Cylinder Capacity (ton)	Stroke (in)	Model Number	Maximum Cylinder Cap. at 10,150 psi (ton)	Side-load Resistance of Maximum Capacity	Cylinder Effective Area (in ²)
60	1.97	LPL-602	68	10%	13.42
100	1.97	LPL-1002	113	10%	22.19
150	1.77	LPL-1602	179	8%	35.18
200	1.77	LPL-2002	223	8%	43.95
250	1.77	LPL-2502	286	5%	56.27
400	1.77	LPL-4002	450	5%	88.75
500	1.77	LPL-5002	575	5%	113.25

Single Acting, Low Height Lock-Nut Cylinders



IMPORTANT!

All LPL-Series cylinders require a solid lifting surface for correct support. The use of these cylinders on surfaces such as sand, mud or dirt, may result in cylinder damage.

INCORRECT!

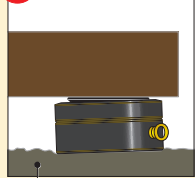

Rough soil

CORRECT!

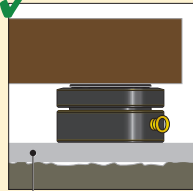

Flat lifting surface

For more safety instructions see our 'Learning Center' on www.enerpac.com

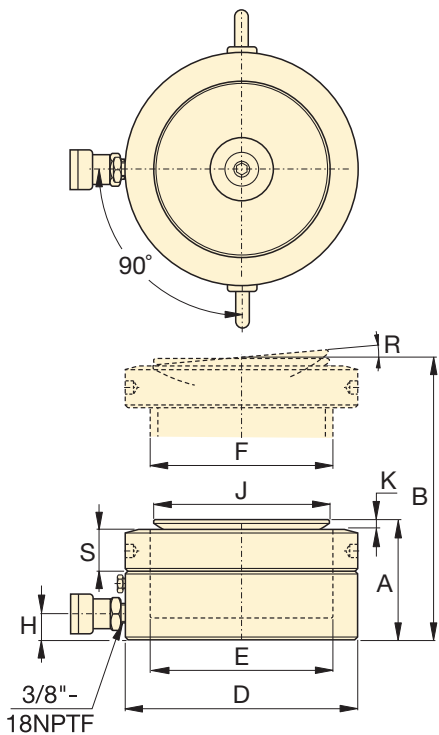

LPL Series



Capacity:
60 - 500 ton

Stroke:
1.77 - 1.97 inch

Maximum Operating Pressure:
10,150 psi



Longer Stroke Lock-Nut Cylinders

For longer stroke applications HCL-Series Lock-Nut Cylinders are the perfect choice.

Page: **4**



Split-Flow Pumps

SFP-Series pumps with multiple outlets with equal oil flow. For lifting and lowering applications on multiple points these pumps are a far better alternative than using separately operated pumps.

Page: **118**



Synchronous Lifting Systems

Pumps for multiple lift-point capabilities. The economical **EVOB-Series** for basic applications and the multi-functional **EVO-Series** lifting system.

Page: **120**

Oil Capacity	Collapsed Height	Extended Height	Outside Diameter	Cylinder Bore Diameter	Plunger Diameter	Base to Advance Port	Saddle Diameter	Saddle Protrusion from Plunger	Saddle Max. Tilt Angle	Lock Nut Height	Wt.	Model Number
(in ³)	A (in)	B (in)	D (in)	E (in)	F (mm)	H (in)	J (in)	K (in)	R (degrees)	S (in)	(lbs)	
26.4	4.94	6.91	5.51	4.13	Tr 105 x 4	0.75	3.78	0.26	5°	1.10	33	LPL-602
43.7	5.39	7.36	6.81	5.31	Tr 135 x 6	0.83	4.96	0.31	5°	1.22	54	LPL-1002
62.3	5.83	7.60	8.66	6.69	Tr 170 x 6	1.06	6.30	0.35	5°	1.57	94	LPL-1602
77.9	6.10	7.87	9.65	7.48	Tr 190 x 6	1.18	7.09	0.39	5°	1.69	121	LPL-2002
99.7	6.24	8.01	10.83	8.46	Tr 215 x 6	1.26	7.87	0.45	5°	1.69	155	LPL-2502
157.2	7.01	8.78	13.78	10.63	Tr 270 x 6	1.56	9.84	0.45	4°	2.17	284	LPL-4002
200.6	7.56	9.33	15.75	12.01	Tr 305 x 6	1.91	11.42	0.39	3°	2.42	404	LPL-5002

▼ Shown from left to right: RSM-1000, RSM-300, RSM-50, RCS-1002, RCS-302



Maximum Power to Height Ratio



Saddles

All **RCS-Series** cylinders have plunger mounting holes for installation of tilt saddles. See table for selection and dimensional information.

Page: **23**



Low Clearance Lifting

The **LW-16** Lifting Wedge and **SOH-Series** Machine Lifts are the perfect choices for lifting loads that have low clearance.

Page: **192**

RSM-Series, Flat-Jac® Cylinders

- Compact, flat design for use where other cylinders will not fit
- RSM-750, 1000 and 1500 have handles for easy carrying
- Mounting holes permit easy fixturing
- Baked enamel finish for increased corrosion resistance
- CR-400 coupler and dust cap included on all models¹⁾
- Hard chrome plated high-quality steel plungers
- Grooved plunger ends require no saddle
- Single-acting spring return

RCS-Series, Low Height Cylinders

- Lightweight, low profile design for use in confined spaces
- Baked enamel finish for increased corrosion resistance
- Plunger wiper reduces contamination, extending cylinder life
- CR-400 coupler and dust cap included on all models
- Grooved plunger end with threaded holes for mounting tilt saddles
- Integral handle on RCS-1002 for easy carrying
- Plated steel plungers
- Single-acting spring return

▼ Only a couple of inches are needed for an RSM-cylinder to lift this large steel construction.



Column 1	Column 2	Column 3	Column 4	Column 5
Cylinder Capacity	Stroke	Model Number	Cyl. Effect. Area	Oil Cap.
(tons) [max.]	(in)		(in ²)	(in ³)
5 [4.9]	.25	RSM-50 ¹⁾	.99	.25
10 [11.2]	.44	RSM-100	2.24	.98
20 [22.1]	.44	RSM-200	4.43	1.94
30 [32.4]	.50	RSM-300	6.49	3.25
50 [48.1]	.63	RSM-500	9.62	6.01
75 [79.5]	.63	RSM-750	15.90	9.94
100 [98.1]	.63	RSM-1000	19.63	12.27
150 [153.4]	.63	RSM-1500	30.68	19.17
10 [11.2]	1.50	RCS-101*	2.24	3.35
20 [22.1]	1.75	RCS-201*	4.43	7.75
30 [32.4]	2.44	RCS-302*	6.49	15.82
50 [48.1]	2.38	RCS-502*	9.62	22.85
100 [98.1]	2.25	RCS-1002*	19.63	44.18

¹⁾ RSM-50 is fitted with an AR-400 coupler.

* Available as a set. See note on next page.

Single-Acting, Low Height Cylinders

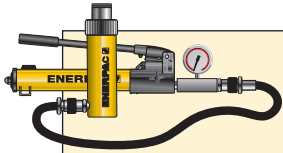

Pump and Cylinder Sets

All cylinders marked with an ** are available as **sets** (cylinder, gauge, couplers, hose and pump) for your ordering convenience.

Page: 52

Optional Bolt On Tilt Saddle Dimensions (in)

For cylinder model:	Model Number	A	B	C*
RCS-201, -302, -502	CAT-51	1.97	.59	1.14
RCS-1002	CAT-101	2.80	.67	1.39

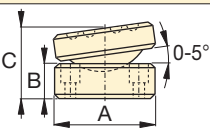

* "C" dimension equals saddle protrusion from plunger. Mounting screws are included.

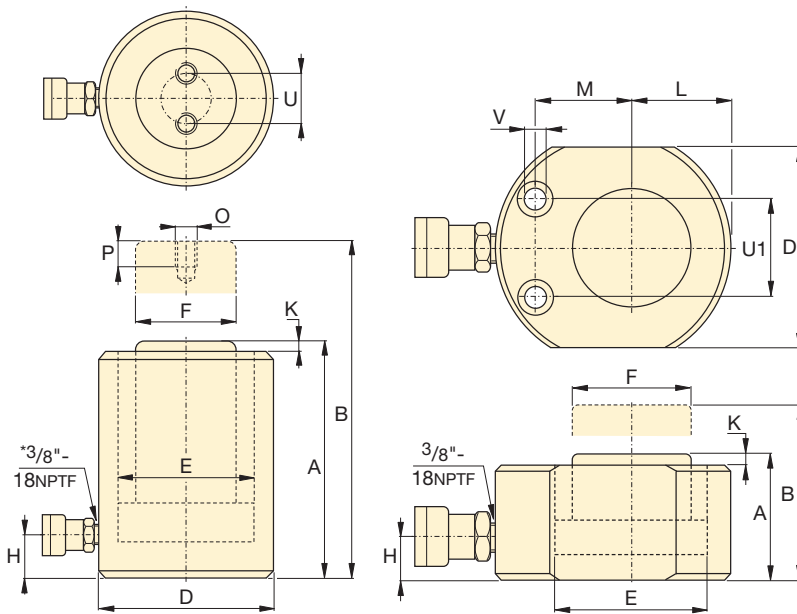

RCS-Series**

RSM-Series

** 5° angle position of coupler on RCS-101, 201, 302.

RSM RCS Series



Capacity:

5-150 tons

Stroke:

.25-2.44 inches

Maximum Operating Pressure:

10,000 psi

RSM Cylinder Mounting Hole Dimensions (in)

Model Number	Hole Pitch U1	Hole Diam. V	Counter Bore Diam.	Counter Bore Depth
RSM-50	1.12	.20	.312	.17
RSM-100	1.44	.28	.422	.31
RSM-200	1.94	.40	.594	.39
RSM-300	2.06	.40	.625	.44
RSM-500	2.62	.47	.750	.50
RSM-750	3.00	.53	.812	.56
RSM-1000	3.00	.53	.812	.56
RSM-1500	4.62	.53	.812	.56

Collapsed Height	Extended Height	Outside Diameter	Cylinder Bore Diameter	Plunger Diameter	Base to Advance Port	Plunger Protrusion from Base	Plunger to Base	Plunger to Mtg. Hole	Thread	Thread Depth	Bolt Circle	Weight	Model Number
A (in)	B (in)	D (in)	E (in)	F (in)	H (in)	K (in)	L (in)	M (in)	O (mm)	P (in)	U (in)	(lbs)	
1.28	1.53	2.31 x 1.63	1.13	1.00	.63	.04	.81	.88	-	-	-	2.3	RSM-50 ¹⁾
1.69	2.13	3.25 x 2.19	1.69	1.50	.75	.04	1.09	1.34	-	-	-	3.1	RSM-100
2.03	2.47	4.00 x 3.00	2.38	2.00	.75	.04	1.56	1.56	-	-	-	6.8	RSM-200
2.31	2.81	4.63 x 3.75	2.88	2.50	.75	.08	1.88	1.75	-	-	-	10	RSM-300
2.63	3.25	5.50 x 4.50	3.50	2.75	.75	.08	2.25	2.13	-	-	-	15	RSM-500
3.13	3.75	6.50 x 5.50	4.50	3.25	.75	.08	2.75	2.63	-	-	-	25	RSM-750
3.38	4.00	7.00 x 6.00	5.00	3.63	.75	.08	3.00	2.94	-	-	-	32	RSM-1000
3.94	4.56	8.50 x 7.50	6.25	4.50	.94	.08	3.75	3.25	-	-	-	58	RSM-1500
3.47	4.97	2.75	1.69	1.50	.69	.20	-	-	M4	.32	1.03	6	RCS-101*
3.88	5.63	3.63	2.38	2.00	.69	.13	-	-	M5	.32	1.57	11	RCS-201*
4.63	7.06	4.00	2.88	2.62	.75	.13	-	-	M5	.32	1.57	15	RCS-302*
4.81	7.19	4.88	3.50	2.75	.94	.08	-	-	M5	.32	1.57	22	RCS-502*
5.56	7.81	6.50	5.00	3.63	1.25	.06	-	-	M8	.40	2.17	46	RCS-1002*

▼ Shown from left to right: BRC-25, BRC-46, BRP-306, BRP-606, BRP-106C



The Ultimate in Pulling Power



Gauges

Minimize the risk of overloading and ensure long, dependable service from your equipment. Refer to the System Components section for a full range of gauges.

Page: 131



Attachments and Accessories

The BRC-25 and BRC-46 units have base, collar and plunger threads to affix a range of optional attachments and accessories, such as chains, saddles and extension tubes.

Page: 187

- High strength alloy steel construction
- Plunger blow-out protection to prevent over-extension
- Hard chrome-plated plunger for long life
- Baked enamel finish for increased corrosion resistance
- CR-400 coupler and dust cap included on all models
- Plunger wiper reduces contamination, extending cylinder life
- Single-acting spring-return
- Replaceable links on BRP-models

▼ Ship building, welding and Enerpac pull cylinders go hand in hand.



▼ To lift a load bearing mast into place, BRP cylinders were used to tension the supporting cables.



Single-Acting, Pull Cylinders

BRC Cylinder Mounting Dimensions (in)				
Model Number	Base Mounting Hole	Collar Thread	Collar Thread Length	Mtg. Thread Length
	V	W	X	Z
BRC-25	3/4"-14 NPT	1 1/2"-16 UN	.98	.67
BRC-46	1 1/4"-11 1/2" NPT	2 1/4"-14 UN	1.06	.98
BRC-106	M30 x 2	M85 x 2	1.02	.98

**BRC
BRP
Series**



Capacity:

2.5-60 tons

Stroke:

5.00-6.00 inches

Maximum Operating Pressure:

10,000 psi

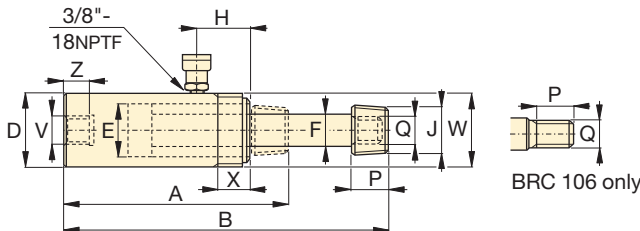

BRC 106 only

BRC-25 to BRC-106

Cylinder Capacity (tons) [maximum]	Stroke (in)	Model Number	Cyl. Effect. Area (in ²)	Oil Cap. (in ³)	Collap. Height		Outside Diam. D (in)	Cyl. Bore Diam. E (in)	Plgr. Diam. F (in)	Top to Inlet Port H (in)	Saddle Diameter J (in)	Plunger Thread Length P (in)	Plunger Outside Thread Q	Weight (lbs)
					A (in)	B (in)								
2.5 [2.7]	5.00	BRC-25	.55	2.76	10.44	15.44	1.89	1.13	.75	1.77	3/4"-14 NPT	1.13	1 1/16"-24	4
5 [5.6]	5.50	BRC-46	1.13	6.21	11.88	17.38	2.25	1.69	1.19	1.69	1 1/4"-11 1/2" NPT	1.25	1 3/16"-16	10
10 [11.6]	5.95	BRC-106	2.32	13.80	11.38	17.33	3.35	2.13	1.25	1.57	-	1.02	M30x2	21

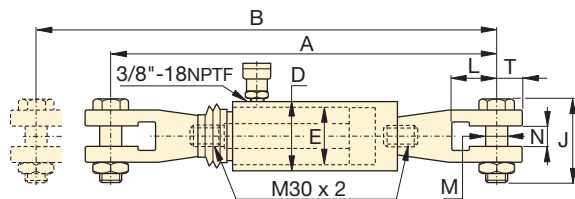

BRP-106C

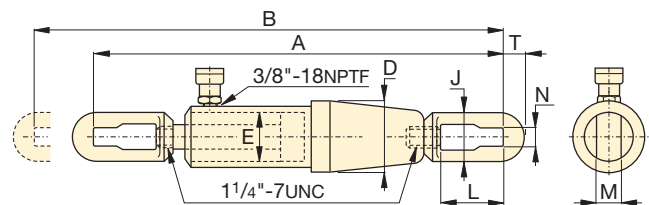

BRP-306

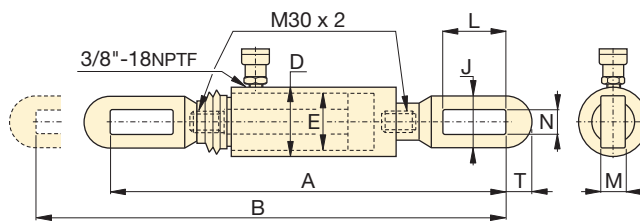

BRP-106L

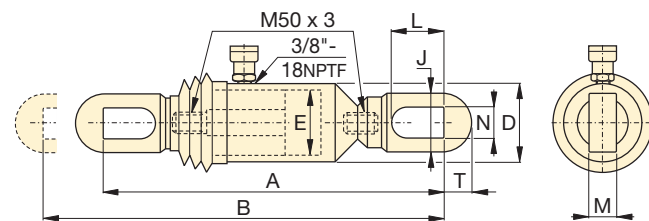

BRP-606

Cylinder Capacity (tons) [maximum]	Stroke (in)	Model Number	Cyl. Effect. Area (in ²)	Oil Capacity (in ³)	Collap. Height		Outside Diam. D (in)	Cyl. Bore Diam. E (in)	Link Height J (in)	Link Opening L (in)	Link Thickness M (in)	Link Width N (in)	Slot to Link End T (in)	Weight (lbs)
					A (in)	B (in)								
10 [11.6]	5.91	BRP-106C	2.45	14.58	23.66	29.57	3.35	2.13	4.13	3.43	1.18	1.38	1.28	34
	5.91	BRP-106L	2.45	14.58	22.87	28.78	3.35	2.13	2.52	4.69	0.87	1.34	1.26	29
30 [36.1]	6.10	BRP-306	7.19	43.63	43.71	49.71	5.39	3.50	4.49	6.10	1.38	1.70	2.17	139
60 [58.8]	6.00	BRP-606	11.17	67.02	28.28	34.28	5.51	4.33	5.12	5.93	1.58	1.89	2.56	129

Note: BRP-106C, BRP-106L and BRP-606 are fitted with rubber bellows for rod protection.

▼ Shown from left to right: RCH-306, RCH-120, RCH-1003



- Hollow plunger design allows for both pull and push forces
- Single-acting spring return
- Nickel-plated, floating center tube on models over 20 tons increases product life
- Baked enamel finish for increased corrosion resistance
- Collar threads for easy fixturing
- RCH-120 includes AR-630 coupler and has 1/4 NPTF port
- RCH-121 and RCH-1211 have FZ-1630 reducer and AR-630 coupler, all other models feature CR-400 coupler

▼ Hollow plunger cylinder RCH-1003 used in an application for intermediate boom suspension on a dragline.



Versatility in Testing, Maintenance and Tensioning Applications

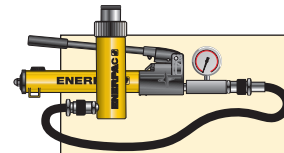

Pump and Cylinder Sets

All cylinders marked with an * are available as **sets** (cylinder, gauge, couplers, hose and pump) for your ordering convenience.

Page: 52



Lightweight Aluminum Hollow Plunger Cylinders

If you need a higher cylinder capacity-to-weight ratio the lightweight **RACH-Series**

Aluminum Hollow Plunger Cylinders are the perfect choice.

Page: 16



Saddles

Most **RCH-Series** cylinders are equipped with smooth saddles. See table at next page for optional threaded saddles and all dimensional information.

Page: 27

Cylinder Capacity	Stroke	Model Number	Cyl. Effect. Area	Oil Cap.
(tons) [maximum]	(in)		(in ²)	(in ³)
12 [13.8]	0.31	RCH-120	2.76	0.86
	1.63	RCH-121*	2.76	4.49
	1.63	RCH-1211	2.76	4.49
	3.00	RCH-123	2.76	8.29
20 [23.6]	2.00	RCH-202*	4.72	9.46
	6.10	RCH-206	4.72	28.67
30 [36.1]	2.50	RCH-302*	7.22	18.05
	6.13	RCH-306	7.22	44.23
60 [63.6]	3.00	RCH-603*	12.73	38.20
	6.00	RCH-606	12.73	76.41
100 [103.1]	3.00	RCH-1003*	20.63	61.88

* Available as a set. See note on this page.

Single-Acting, Hollow Plunger Cylinders



Hoses

Enerpac offers a complete line of high quality hydraulic hoses. To ensure the integrity of your system, specify only Enerpac hydraulic hoses.

Page: 132

Optional Heat Treated Hollow Saddles

Saddle Type	Cylinder Model No.	Saddle Model No.	Saddle Dimensions (in)		
			A	B	C
Threaded Hollow	RCH-202, 206	HP-2015	2.11	1"-8	.38
	RCH-302, 306	HP-3015	2.49	1 1/4"-7	.38
	RCH-603, 606	HP-5016	3.61	1 5/8"-5 1/2"	.50
	RCH-1003	HP-10016	4.97	2 1/2"-8	.51

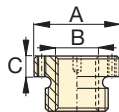

Smooth hollow saddles are standard on all RCH-models (12-ton models are not equipped with saddles).

RCH-121 and RCH-1211 have a 1.88" diameter boss that protrudes 0.25" from base.

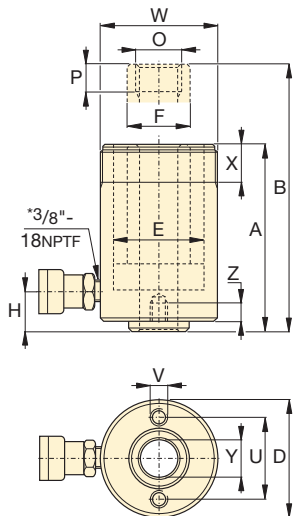

RCH-120* to RCH-123 models

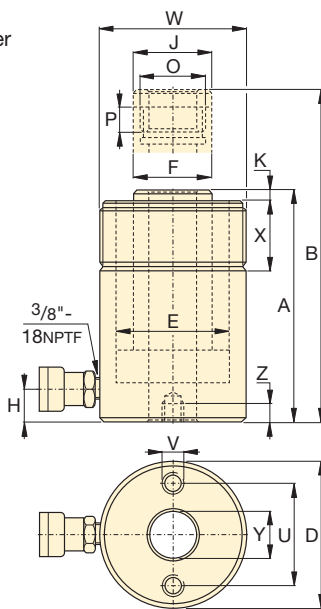

RCH-202 to RCH-1003 models

* 1/4" NPT for RCH-120 only

RCH Series



Capacity:

12-100 tons

Stroke:

.31-6.13 inches

Center Hole Diameter:

.68-3.11 inches

Maximum Operating Pressure:

10,000 psi

Base Mounting Hole Dimensions (in)

Model Number	Bolt Circle		
	U	V	Z
RCH-120	2.00	5/16"-18 UNC	.35
RCH-121	-	-	-
RCH-1211	-	-	-
RCH-123	2.00	5/16"-18 UNC	.50
RCH-202	3.25	3/8"-16 UNC	.37
RCH-206	3.25	3/8"-16 UNC	.37
RCH-302	3.63	3/8"-16 UNC	.55
RCH-306	3.63	3/8"-16 UNC	.55
RCH-603	5.13	1/2"-13 UNC	.55
RCH-606	5.13	1/2"-13 UNC	.55
RCH-1003	7.00	5/8"-11 UNC	.75

Collap. Height	Ext. Height	Outside Diam.	Cyl. Bore Diam.	Plngr. Diam.	Cyl. Base to Advance Port	Saddle Diameter	Saddle Protrusion from Plngr.	Plunger Internal Thread	Plunger Thread Length	Collar Thread	Collar Thread Length	Center Hole Diam.	Weight	Model Number
A (in)	B (in)	D (in)	E (in)	F (in)	H (in)	J (in)	K (in)	O (in)	P (in)	W (in)	X (in)	Y (in)	(lbs)	
2.19	2.50	2.75	2.13	1.38	.38	-	-	3/4"-16 UN	.63	2 3/4"-16	1.19	.68	3.2	RCH-120
4.75	6.38	2.75	2.13	1.38	.98	-	-	-	-	2 3/4"-16	1.19	.77	6.2	RCH-121*
4.75	6.38	2.75	2.13	1.38	.98	-	-	3/4"-16 UN	.63	2 3/4"-16	1.19	.68	6.2	RCH-1211
7.25	10.25	2.75	2.13	1.38	.98	-	-	-	-	2 3/4"-16	1.19	.77	9.8	RCH-123
6.38	8.38	3.88	2.88	2.13	.75	2.13	.27	1 9/16"-16 UN	.75	3 7/8"-12	1.50	1.06	17	RCH-202*
12.05	18.11	3.88	2.88	2.13	.75	2.13	.27	1 9/16"-16 UN	.75	3 7/8"-12	1.50	1.06	31	RCH-206
7.03	9.53	4.50	3.50	2.50	.85	2.50	.38	1 13/16"-16 UN	.88	4 1/2"-12	1.66	1.31	24	RCH-302*
13.00	19.13	4.50	3.50	2.50	1.00	2.50	.38	1 13/16"-16 UN	.88	4 1/2"-12	1.66	1.31	48	RCH-306
9.75	12.75	6.25	4.88	3.63	1.25	3.61	.50	2 3/4"-16 UN	.75	6 1/4"-12	1.91	2.12	62	RCH-603*
12.75	18.75	6.25	4.88	3.63	1.25	3.61	.50	2 3/4"-16 UN	.75	6 1/4"-12	1.91	2.12	78	RCH-606
10.00	13.00	8.38	6.50	5.00	1.50	4.97	.50	4"-16 UN	1.00	8 3/8"-12	2.38	3.11	132	RCH-1003*

▼ Shown from left to right: RRH-3010, RRH-1001, RRH-6010



Versatility in Testing, Maintenance and Tensioning Applications



Pump Selection

A double-acting cylinder must be powered by a pump with a 4-way valve.

Page: 123



Gauges

Minimize the risk of overloading and ensure long, dependable service from your equipment. Refer to the System Components section for a full range of gauges.

Page: 131



Saddles

All RRH-Series cylinders are equipped with smooth saddles. See table on next page for optional threaded saddles and all dimensional information.

Page: 29

- Relief valves prevent damage in case of over-pressurization
- Baked enamel finish for increased corrosion resistance
- Collar threads enable easy fixturing (except RRH-1001 and RRH-1508)
- Double-acting operation for fast retraction
- Nickel-plated, floating center tube increases product life
- Hollow plunger allows for both pull and push forces
- CR-400 couplers and dust caps included on all models
- Plunger wiper reduces contamination, extending cylinder life

▼ Double-acting hollow-plunger cylinders are applied for bridge launching systems.



Cylinder Capacity (ton)	Stroke (in)	Model Number	Max. Cylinder Capacity (ton)		Cylinder Effective Area (in ²)		Oil Capacity (in ³)	
			Advance	Retract	Advance	Retract	Advance	Retract
30	7.00	RRH-307	36	24	7.22	4.71	50.55	32.99
	10.13	RRH-3010	36	24	7.22	4.71	73.12	47.71
60	3.50	RRH-603	64	42	12.73	8.37	44.57	29.21
	6.50	RRH-606	64	42	12.73	8.37	82.77	54.24
	10.12	RRH-6010	64	42	12.73	8.37	128.94	84.49
100	1.50	RRH-1001	103	68	20.63	13.54	30.94	20.32
	3.00	RRH-1003	103	68	20.63	13.54	61.88	40.64
	6.00	RRH-1006	103	68	20.63	13.54	123.76	81.29
	10.13	RRH-10010	103	68	20.63	13.54	208.84	137.17
150	8.00	RRH-1508	158	80	31.62	15.91	252.97	127.23

Double-Acting, Hollow Plunger Cylinders



Hoses

Enerpac offers a complete line of high-quality hydraulic hoses. To ensure the integrity of your system, specify only Enerpac hydraulic hoses.

Page: 132

RRH Series



Capacity:

30-150 tons

Stroke:

1.50-10.13 inches

Center Hole Diameter:

1.31-3.13 inches

Maximum Operating Pressure:

10,000 psi

Optional Heat Treated Saddles

Saddle Type	Cylinder Model Number	Saddle Model No.	Saddle Dimensions (in)		
			A	B	C
Threaded Hollow	RRH-307, 3010	HP-3015	2.49	1 1/4"-7	.38
	RRH-603, 606, 6010	HP-5016	3.61	1 5/8"-5 1/2	.50
	RRH-1001, 1003, RRH-1006, 10010	HP-10016	4.97	2 1/2"-8	.51

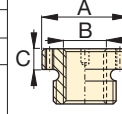

Smooth hollow saddles are standard on all RRH-models.

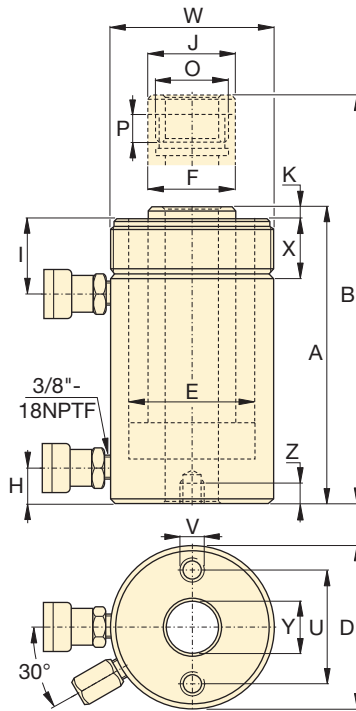

Base Mounting Hole Dimensions (in)

Model Number	Bolt Circle U	Thread V	Thread Depth Z
RRH-307	3.63	3/8" - 16	.62
RRH-3010	3.63	3/8" - 16	.62
RRH-603	5.12	1/2" - 13	.55
RRH-606	5.12	1/2" - 13	.55
RRH-6010	5.12	1/2" - 13	.55
RRH-1001	7.00	5/8" - 11	.75
RRH-1003	7.00	5/8" - 11	.75
RRH-1006	7.00	5/8" - 11	.75
RRH-10010	7.00	5/8" - 11	.75
RRH-1508	-	-	-

Collap. Height	Ext. Height	Out. Diam.	Cyl. Bore Diam.	Plngr. Diam.	Cyl. Base to Adv. Port	Cyl. Top to Return Port	Saddle Diam.	Saddle Protrusion from Plngr.	Thread	Plunger Thread Length	Collar Thread	Collar Thread Length	Center Hole Diam.	Wt.	Model Number
A	B	D	E	F	H	I	J	K	O	P	W	X	Y	(lbs)	
(in)	(in)	(in)	(in)	(in)	(in)	(in)	(in)	(in)	(in)	(in)	(in)	(in)	(in)		
13.00	20.00	4.50	3.50	2.50	1.00	2.38	2.50	.38	1 13/16"-16	.88	4 1/2"-12	1.66	1.31	48	RRH-307
17.00	27.13	4.50	3.50	2.50	1.00	2.38	2.50	.38	1 13/16"-16	.88	4 1/2"-12	1.66	1.31	60	RRH-3010
9.75	13.25	6.25	4.88	3.63	1.25	2.63	3.61	.50	2 3/4"-16	.75	6 1/4"-12	1.91	2.13	62	RRH-603
12.75	19.25	6.25	4.88	3.63	1.25	2.63	3.61	.50	2 3/4"-16	.75	6 1/4"-12	1.91	2.13	78	RRH-606
17.25	27.38	6.25	4.88	3.63	1.25	2.63	3.61	.50	2 3/4"-16	.75	6 1/4"-12	1.91	2.13	101	RRH-6010
6.50	8.00	8.38	6.50	5.00	1.50	1.75	4.97	.50	4"-16	1.00	-	-	3.13	85	RRH-1001
10.00	13.00	8.38	6.50	5.00	1.50	3.38	4.97	.50	4"-16	1.00	8 3/8"-12	2.38	3.13	135	RRH-1003
13.50	19.50	8.38	6.50	5.00	1.50	3.38	4.97	.50	4"-16	1.00	8 3/8"-12	2.38	3.13	175	RRH-1006
18.13	28.25	8.38	6.50	5.00	1.50	3.38	4.97	.50	4"-16	1.00	8 3/8"-12	2.38	3.13	235	RRH-10010
13.75	21.75	9.75	7.50	6.00	1.50	2.38	5.00	.19	4 1/4"-12	1.00	-	-	3.13	245	RRH-1508

▼ Shown from left to right: RD-2510, RD-96, RD-256, RD-41, RD-166



High Precision and High Cycle Performance



Speed Chart

See the Enerpac Cylinder Speed Chart in our 'Yellow Pages' to determine your approximate cylinder speed.

Page: 283

- Designed for long life, the best choice for production applications
- Unique mounting configurations simplify fixturing
- Baked enamel finish for increased corrosion resistance
- Double-acting operation develops force in both directions, providing maximum versatility
- Plunger wiper reduces contamination, extending cylinder life

▼ Clamping application using Enerpac RD cylinders (with clevis eye attachments on both ends) for their high-pressure capability and mounting flexibility.

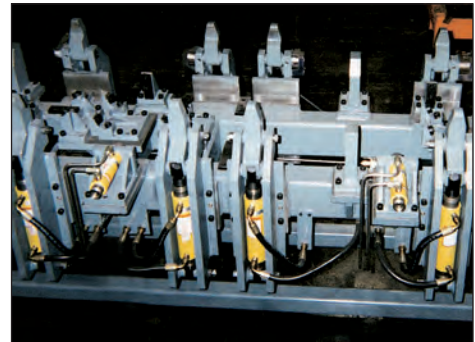

Cylinder Capacity (tons)	Stroke (in)	Model Number	Max. Cylinder Capacity (tons)		Cylinder Effective Area (in ²)		Oil Capacity (in ³)		Collap. Height A (in)	Ext. Height B (in)	Body Length C (in)	Outside Diam. D (in)	Cylinder Bore Diam. E (in)	Plunger Diam. F (in)
			Advance	Retract	Advance	Retract	Advance	Retract						
4	1.13	RD-41	4	2	.79	.34	.88	.39	7.31	8.44	6.38	2.00	1.00	.75
	3.13	RD-43	4	2	.79	.34	2.45	1.07	9.31	12.44	8.38	2.00	1.00	.75
	6.13	RD-46	4	2	.79	.34	4.81	2.10	12.31	18.44	11.38	2.00	1.00	.75
9	1.13	RD-91	9	5	1.77	.98	1.99	1.10	8.75	9.88	7.80	2.50	1.50	1.00
	3.13	RD-93	9	5	1.77	.98	5.52	3.07	10.78	13.91	9.80	2.50	1.50	1.00
	6.13	RD-96	9	5	1.77	.98	10.82	6.01	13.78	19.91	12.80	2.50	1.50	1.00
	10.13	RD-910	9	5	1.77	.98	17.89	9.94	17.78	27.91	16.81	2.50	1.50	1.00
16	6.25	RD-166	16	8	3.14	1.66	19.63	10.35	15.31	21.56	14.13	3.00	2.00	1.38
	10.25	RD-1610	16	8	3.14	1.66	32.20	16.98	19.31	29.56	18.11	3.00	2.00	1.38
25	6.25	RD-256	25	11	4.91	2.15	30.68	13.42	16.69	22.94	15.63	3.63	2.50	1.88
	10.25	RD-2510	25	11	4.91	2.15	50.31	22.01	20.69	30.94	19.61	3.63	2.50	1.88

Double-Acting, Precision Production Cylinders

▼ RD CYLINDER ATTACHMENTS

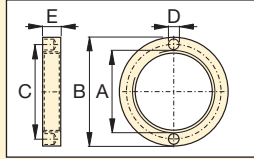

Retainer Nut
For locking foot or flange mountings. Tightens onto cylinder collar threads (included with foot and flange mounting kits)

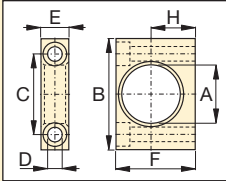

Foot Mounting
Mounts onto cylinder collar. Mounting screws not included.

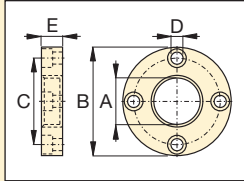

Flange Mounting
Mounts onto cylinder collar. Mounting screws not included.

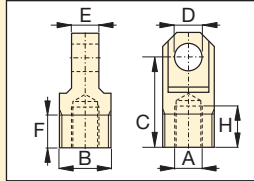

Clevis Eye
Threads onto plunger or into cylinder base

Model Number	RD-Cyl: (tons)	Dimensions (in)							
		A	B	C	D	E	F	H	
Foot Mounting with Retainer Nut									
AD-141	4	1.38	3.00	2.00	.41	.75	2.25	1.25	
AD-171	9	2.00	4.00	2.88	.53	1.00	3.25	1.75	
AD-181	16	2.63	5.00	3.75	.78	1.38	4.00	2.06	
AD-191	25	3.25	6.25	4.62	1.03	1.75	4.88	2.50	
Flange Mounting with Retainer Nut									
AD-142	4	1.38	3.88	3.09	.41	.75	-	-	
AD-172	9	2.00	4.75	3.88	.41	1.00	-	-	
AD-182	16	2.63	5.63	4.56	.53	1.38	-	-	
AD-192	25	3.25	6.50	5.34	.66	1.75	-	-	
Retainer Nut									
AD-143	4	1.375-12 UNF	2.25	1.81	.25	.38	-	-	
AD-173	9	2.000-12 UN	3.00	2.50	.27	.50	-	-	
AD-183	16	2.625-16 UN	3.63	3.12	.27	.75	-	-	
AD-193	25	3.250-16 UN	4.25	3.75	.27	1.00	-	-	
Clevis Eye									
AD-150	4	.500-20 UNF	1.125-20 UN	2.06	.63	.62	.75	.94	
AD-151	9	.750-16 UNF	1.688-18 UNEF	2.25	.75	1.00	1.00	.94	
AD-152	16	1.125-12 UNF	2.188-16 UNS	3.06	1.00	1.25	1.00	1.19	
AD-153	25	1.500-12 UNF	2.750-16	3.06	1.25	1.50	1.00	1.06	

RD Series



Capacity:
4-25 tons

Stroke:
1.13-10.25 inches

Maximum Operating Pressure:
10,000 psi

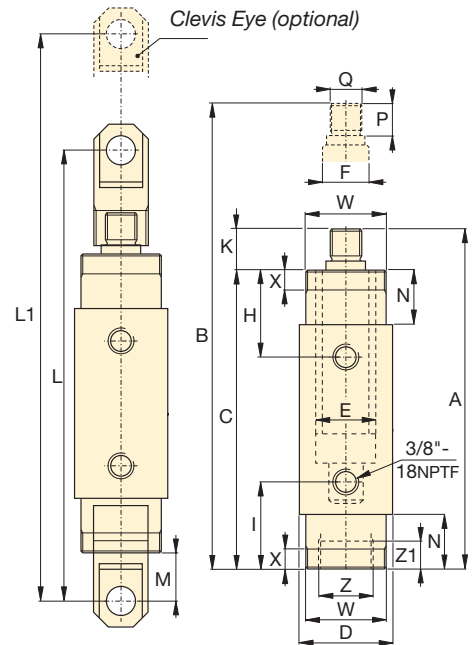

Top to Ret. Port H (in)	Bottom to Adv. Port I (in)	Plunger Protrusion K (in)	Clevis Eye Mounting Dimensions			Neck Length N (in)	Plunger Thread Length P (in)	Plunger External Thread Q (in)	Cylinder Mounting Dimensions (in)				Wt. (lbs)	Model Number
			L (in)	L1 (in)	M (in)				Collar Thread W	Collar Thread Length X	Int. Base Thread Z	Int. Base Thread Length Z1		
1.88	1.88	.94	10.12	11.25	1.61	1.13	.75	1/2"-20	1 3/8"-12	.44	1 1/8"-20	.35	4.8	RD-41
1.88	1.88	.94	12.12	15.25	1.61	1.13	.75	1/2"-20	1 3/8"-12	.44	1 1/8"-20	.35	6.4	RD-43
1.88	1.88	.94	15.12	21.25	1.61	1.13	.75	1/2"-20	1 3/8"-12	.44	1 1/8"-20	.35	9.0	RD-46
2.27	2.27	.98	11.61	12.76	1.50	1.50	.75	3/4"-16	2"-12	.56	1 11/16"-18	.55	9.0	RD-91
2.27	2.27	.98	13.66	16.79	1.50	1.50	.75	3/4"-16	2"-12	.56	1 11/16"-18	.55	11.0	RD-93
2.27	2.27	.98	16.66	22.79	1.50	1.50	.75	3/4"-16	2"-12	.56	1 11/16"-18	.55	14.0	RD-96
2.27	2.27	.98	20.66	30.79	1.50	1.50	.75	3/4"-16	2"-12	.56	1 11/16"-18	.55	19.0	RD-910
2.90	2.90	1.19	19.32	25.57	2.05	2.13	1.00	1 1/8"-12	2 5/8"-16	.88	2 3/16"-16	.94	22.0	RD-166
2.90	2.90	1.19	23.32	33.57	2.05	2.13	1.00	1 1/8"-12	2 5/8"-16	.88	2 3/16"-16	.94	29.0	RD-1610
3.50	3.50	1.06	20.86	27.11	2.09	2.75	1.00	1 1/2"-12	3 1/4"-16	1.13	2 3/4"-16	1.02	36.0	RD-256
3.50	3.50	1.08	24.86	35.11	2.09	2.75	1.00	1 1/2"-12	3 1/4"-16	1.13	2 3/4"-16	1.02	46.0	RD-2510

▼ Shown from left to right: RR-10013, RR-1502, RR-20013, RR-1010, RR-7513



Most Versatile Performers

Rugged enough for the toughest job site uses and precision designed for high-cycle industrial uses.



Pump Selection

A double-acting cylinder must be powered by a pump with a 4-way valve.

Page: 123



Saddles

RR-Series cylinders up to 75-ton have plunger thread for installation of CAT-Series tilt saddles.

Page: 33



Optimum Performance

Enerpac's range of Z-Class electric pumps, fitted with manual or solenoid operated 4-way valves, offer optimum combinations with RR cylinders.

Page: 90

- Collar threads, plunger threads and base mounting holes for easy fixturing (on most models)
- Baked enamel finish for increased corrosion resistance
- Removable hardened saddles protect plunger during lifting and pressing
- Built-in safety valve prevents accidental over-pressurization
- CR-400 couplers included on all models
- Plunger wiper reduces contamination, extending cylinder life

▼ These long stroke RR-cylinders are attached to a sliding and guiding system pulling the arched roof assembly of Athen's Olympic Stadium step-by-step into the final position.



▼ RR-cylinders provide power and precision in a special hydraulic press.

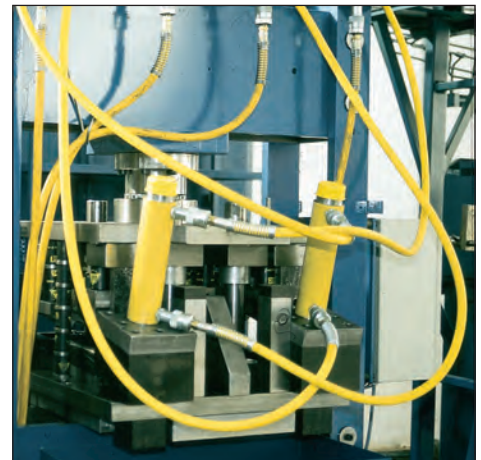

Double-Acting Long Stroke Cylinders

▼ QUICK SELECTION CHART

For complete technical information see next page.

Cylinder Capacity (tons)	Stroke (in)	Model Number	Cylinder Effective Area (in ²)		Oil Capacity (in ³)		Collap. Height (in)
			Push	Pull	Push	Pull	
			10	10.00	RR-1010*	2.23	
	12.00	RR-1012*	2.23	.80	26.80	9.00	18.00
30	8.25	RR-308*	6.51	3.00	53.67	25.00	15.25
	14.50	RR-3014*	6.51	3.00	92.70	43.00	21.63
50	6.13	RR-506	11.06	3.40	67.77	21.00	13.06
	13.13	RR-5013	11.06	3.40	145.17	44.00	20.06
	20.13	RR-5020	11.06	3.40	222.56	68.00	28.88
75	6.13	RR-756	15.92	4.90	97.58	29.00	13.69
	13.13	RR-7513	15.92	4.90	209.00	64.00	20.69
100	6.63	RR-1006	20.65	9.60	136.93	63.00	14.06
	13.13	RR-10013	20.65	9.60	271.17	126.00	20.63
	18.13	RR-10018	20.65	9.60	374.44	174.00	27.06
150	2.25	RR-1502	30.71	14.80	69.11	33.00	7.72
	6.13	RR-1506	30.71	14.80	188.28	91.00	15.19
	13.13	RR-15013	30.71	14.80	403.27	194.00	22.20
	32.13	RR-15032	30.71	14.80	986.84	475.00	43.94
200	6.00	RR-2006	44.21	22.50	265.28	135.00	16.94
	13.00	RR-20013	44.21	22.50	574.78	293.00	23.94
	18.00	RR-20018	44.21	22.50	795.85	396.00	30.13
	24.00	RR-20024	44.21	22.50	1,061	528.00	36.13
	36.00	RR-20036	44.21	22.50	1,592	792.00	48.13
	48.00	RR-20048	44.21	22.50	2,122	1,056	60.13
300	6.00	RR-3006	70.93	38.00	425.56	228.00	19.13
	12.00	RR-30012	70.93	38.00	851.12	456.00	25.13
	18.00	RR-30018	70.93	38.00	1,277	684.00	31.13
	24.00	RR-30024	70.93	38.00	1,702	912.00	37.13
	36.00	RR-30036	70.93	38.00	2,553	1,368	49.13
	48.00	RR-30048	70.93	38.00	3,405	1,824	61.13
400	6.00	RR-4006	95.09	51.00	570.51	306.00	21.19
	12.00	RR-40012	95.09	51.00	1,141	612.00	27.19
	18.00	RR-40018	95.09	51.00	1,712	918.00	33.19
	24.00	RR-40024	95.09	51.00	2,282	1,224	39.19
	36.00	RR-40036	95.09	51.00	3,423	1,836	51.19
	48.00	RR-40048	95.09	51.00	4,564	2,448	63.19
500	6.00	RR-5006	113.15	63.00	678	378.00	22.75
	12.00	RR-50012	113.15	63.00	1,358	756.00	28.75
	18.00	RR-50018	113.15	63.00	2,037	1,134	34.75
	24.00	RR-50024	113.15	63.00	2,716	1,512	40.75
	36.00	RR-50036	113.15	63.00	4,074	2,264	52.75
	48.00	RR-50048	113.15	63.00	5,431	3,024	64.75

RR Series



Capacity:

10-500 tons

Stroke:

2.25-48.00 inches

Maximum Operating Pressure:

10,000 psi



Enerpac HCR-Series

If you do not have a high-cycle application, Enerpac **HCR-Series** cylinders may be the right alternative.

Page: 44



Speed Chart

See the Enerpac Cylinder Speed Chart in our "Yellow Pages"

to determine your approximate cylinder speed. Page: 283



Optional Snap-in Saddles

Optional snap-in saddles for RR-Series double-acting cylinders:

Saddle Type	Cylinder Model Number	Saddle Model Number
Flat	RR-1010, 1012	A-102F
Tilt	RR-1010, 1012	CAT-10
	RR-308, 3014	CAT-50
	RR-506, 5013	CAT-100
	RR-5020, 756	
	RR-7513	

Standard Saddles

Grooved	RR-1010, 1012	A-102G
	RR-308, 3014	A-252G

For additional information on saddles:

Page: 10

RR-Series, Double-Acting Cylinders

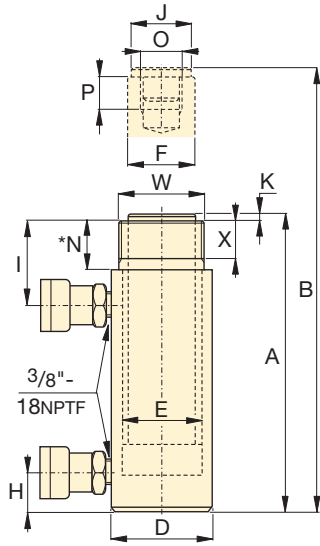

RR-1010 to RR-3014 models

* For RR-1010 and RR-1012:
N = 1.26 inch; for RR-308 and
RR-3014: N = 2.20 inch.

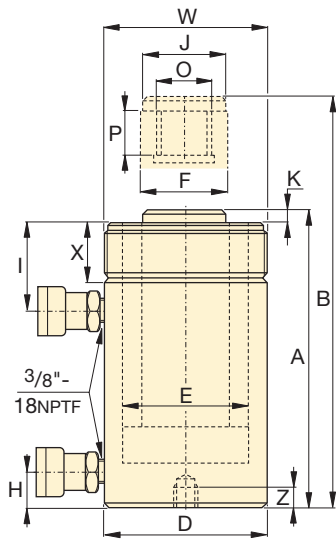

RR-506 to RR-50048 models

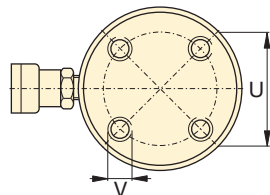

RR-1006 to RR-30048

No mounting holes:
RR-506, 5013
RR-756, 7513
RR-1502, 15032



Cylinder retract capacity for certain RR cylinders may be less than theoretical values, as a result of reduced relief valve pressure settings:

RR-308/3014: 4000 psi
RR-506/5013/5020: 6950 psi
RR-756/7513: 7200 psi

◀ For full features see page 32.

Cylinder Capacity (ton)	Stroke (in)	Model Number	Max. Cylinder Capacity (tons)		Cylinder Effective Area (in ²)		Oil Capacity (in ³)		Collap. Height	Ext. Height	Outside Diam.
			Push	Pull	Push	Pull	Push	Pull	A (in)	B (in)	D (in)
10	10.00	RR-1010*	11.1	4.0	2.23	.80	22.33	8.00	16.13	26.13	2.88
	12.00	RR-1012*	11.1	4.0	2.23	.80	26.80	9.00	18.00	30.00	2.88
30	8.25	RR-308*	32.5	6.0	6.51	3.00	53.67	25.00	15.25	23.50	4.00
	14.50	RR-3014*	32.5	6.0	6.51	3.00	92.70	43.00	21.63	36.13	4.00
50	6.13	RR-506	55.3	11.8	11.06	3.40	67.77	21.00	13.06	19.19	5.00
	13.13	RR-5013	55.3	11.8	11.06	3.40	145.17	44.00	20.06	33.19	5.00
	20.13	RR-5020	55.3	11.8	11.06	3.40	222.56	68.00	28.88	49.00	5.00
75	6.13	RR-756	79.6	17.6	15.92	4.90	97.58	29.00	13.69	19.81	5.75
	13.13	RR-7513	79.6	17.6	15.92	4.90	209.00	64.00	20.69	33.81	5.75
100	6.63	RR-1006	103.2	48.0	20.65	9.60	136.93	63.00	14.06	20.69	7.00
	13.13	RR-10013	103.2	48.0	20.65	9.60	271.17	126.00	20.63	33.75	7.00
	18.13	RR-10018	103.2	48.0	20.65	9.60	374.44	174.00	27.06	45.19	7.00
150	2.25	RR-1502	153.5	74.0	30.71	14.80	69.11	33.00	7.19	9.44	8.00
	6.13	RR-1506	153.5	74.0	30.71	14.80	188.28	91.00	15.19	21.31	8.00
	13.13	RR-15013	153.5	74.0	30.71	14.80	403.27	194.00	22.20	35.31	8.00
	32.13	RR-15032	153.5	74.0	30.71	14.80	986.84	475.00	43.94	76.06	8.00
200	6.00	RR-2006	221.0	112.5	44.21	22.50	265.28	135.00	16.94	22.94	9.75
	13.00	RR-20013	221.0	112.5	44.21	22.50	574.78	293.00	23.94	36.94	9.75
	18.00	RR-20018	221.0	112.5	44.21	22.50	795.85	396.00	30.13	48.13	9.75
	24.00	RR-20024	221.0	112.5	44.21	22.50	1,061	528.00	36.13	60.13	9.75
	36.00	RR-20036	221.0	112.5	44.21	22.50	1,592	792.00	48.13	84.13	9.75
300	48.00	RR-20048	221.0	112.5	44.21	22.50	2,122	1,056	60.13	108.13	9.75
	6.00	RR-3006	354.6	190.0	70.93	38.00	425.56	228.00	19.13	25.13	12.25
	12.00	RR-30012	354.6	190.0	70.93	38.00	851.12	456.00	25.13	37.13	12.25
	18.00	RR-30018	354.6	190.0	70.93	38.00	1,277	684.00	31.13	49.13	12.25
	24.00	RR-30024	354.6	190.0	70.93	38.00	1,702	912.00	37.13	61.13	12.25
400	36.00	RR-30036	354.6	190.0	70.93	38.00	2,553	1368	49.13	85.13	12.25
	48.00	RR-30048	354.6	190.0	70.93	38.00	3,405	1824	61.13	109.13	12.25
	6.00	RR-4006	475.4	255.0	95.09	51.00	570.51	306.00	21.19	27.19	14.13
	12.00	RR-40012	475.4	255.0	95.09	51.00	1,141	612.00	27.19	39.19	14.13
	18.00	RR-40018	475.4	255.0	95.09	51.00	1,712	918.00	33.19	51.19	14.13
500	24.00	RR-40024	475.4	255.0	95.09	51.00	2,282	1224	39.19	63.19	14.13
	36.00	RR-40036	475.4	255.0	95.09	51.00	3,423	1836	51.19	87.19	14.13
	48.00	RR-40048	475.4	255.0	95.09	51.00	4,564	2448	63.19	111.19	14.13
	6.00	RR-5006	565.7	315.0	113.15	63.00	678.92	378.00	22.75	28.75	15.63
	12.00	RR-50012	565.7	315.0	113.15	63.00	1,358	756.00	28.75	40.75	15.63
500	18.00	RR-50018	565.7	315.0	113.15	63.00	2,037	1134	34.75	52.75	15.63
	24.00	RR-50024	565.7	315.0	113.15	63.00	2,716	1512	40.75	64.75	15.63
	36.00	RR-50036	565.7	315.0	113.15	63.00	4,074	2268	52.75	88.75	15.63
48.00	RR-50048	565.7	315.0	113.15	63.00	5,431	3024	64.75	112.75	15.63	

* For RR-1010 and RR-1012: N = 1.26 inch; for RR-308 and RR-3014: N = 2.20 inch.

Double-Acting Long Stroke Cylinders

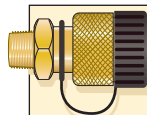

Couplers Included!

CR-400 couplers included on all models. Fits all HC-Series hoses.

Capacity:
10-500 tons

Stroke:
2.25-48.00 inches

Maximum Operating Pressure:
10,000 psi

RR Series



Cylinder Bore Diameter	Plunger Diameter	Base to Adv. Port	Top to Return Port	Saddle Diameter	Saddle Protrusion from Plngr.	Plunger Internal Thread	Plunger Thread Length	Base Mounting Holes			Collar Thread	Collar Thread Length	Weight (lbs)	Model Number
								Bolt Cir. Diam.	Thread	Thread Depth				
E (in)	F (in)	H (in)	I (in)	J (in)	K (in)	O (in)	P (in)	U (in)	V (in)	Z (in)	W (in)	X (in)		
1.69	1.38	1.44	2.25	1.38	.24	1-8	1.00	-	-	-	2 1/4-14	1.06	28	RR-1010*
1.69	1.38	1.44	2.25	1.38	.24	1-8	1.00	-	-	-	2 1/4-14	1.06	31	RR-1012*
2.88	2.13	1.44	3.19	2.00	.41	1 1/2-16	1.00	-	-	-	3 5/16-12	1.94	40	RR-308*
2.88	2.13	1.56	3.19	2.00	.41	1 1/2-16	1.00	-	-	-	3 5/16-12	1.94	64	RR-3014*
3.75	3.13	1.13	3.00	2.81	.11	1-12	1.00	-	-	-	5-12	2.00	67	RR-506
3.75	3.13	1.13	3.00	2.81	.11	1-12	1.00	-	-	-	5-12	2.00	115	RR-5013
3.75	3.13	2.25	3.00	2.81	.11	1-12	1.00	3.00	-	-	5-12	2.00	150	RR-5020
4.50	3.75	1.19	3.00	2.81	.25	1-12	1.50	-	-	-	5 3/4-12	1.50	92	RR-756
4.50	3.75	1.19	3.19	2.81	.25	1-12	1.50	-	-	-	5 3/4-12	1.50	150	RR-7513
5.13	3.75	1.50	2.81	3.00	.13	1 3/4-12	1.38	5.50	3/4-10	1.00	6 7/8-12	2.00	135	RR-1006
5.13	3.75	1.50	2.81	3.00	.13	1 3/4-12	1.38	5.50	3/4-10	1.00	6 7/8-12	2.00	205	RR-10013
5.13	3.75	1.63	3.63	3.00	.13	1 3/4-12	1.38	5.50	3/4-10	1.00	6 7/8-12	2.00	260	RR-10018
6.25	4.50	.88	2.63	3.67	.06	-	-	-	-	-	-	-	110	RR-1502
6.25	4.50	1.94	3.31	4.49	.75	3 3/8-16	1.38	6.25	3/4-16	1.00	8-12	2.36	205	RR-1506
6.25	4.50	1.94	3.31	4.49	.75	3 3/8-16	1.38	6.25	3/4-16	1.00	8-12	2.36	275	RR-15013
6.25	4.50	3.31	3.31	4.49	.75	3 3/8-16	1.38	-	-	-	8-12	2.36	525	RR-15032
7.50	5.25	2.25	3.81	5.25	.88	-	-	5.00	1-8	1.00	-	-	325	RR-2006
7.50	5.25	2.25	3.81	5.25	.88	2 1/2-12	2.50	5.00	1-8	1.00	9 3/4-12	2.13	440	RR-20013
7.50	5.25	3.38	4.00	5.25	.88	2 1/2-12	2.50	5.00	1-8	1.00	9 3/4-12	2.13	450	RR-20018
7.50	5.25	3.38	4.00	5.25	.88	2 1/2-12	2.50	5.00	1-8	1.00	9 3/4-12	2.13	616	RR-20024
7.50	5.25	3.38	4.00	5.25	.88	2 1/2-12	2.50	5.00	1-8	1.00	9 3/4-12	2.13	845	RR-20036
7.50	5.25	3.38	4.00	5.25	.88	2 1/2-12	2.50	5.00	1-8	1.00	9 3/4-12	2.13	1065	RR-20048
9.50	6.50	3.50	4.50	6.50	1.13	2 1/2-12	3.25	6.25	1 1/4-7	1.75	12 1/4-12	2.31	441	RR-3006
9.50	6.50	3.50	4.50	6.50	1.13	2 1/2-12	3.25	6.25	1 1/4-7	1.75	12 1/4-12	2.31	608	RR-30012
9.50	6.50	3.50	4.50	6.50	1.13	2 1/2-12	3.25	6.25	1 1/4-7	1.75	12 1/4-12	2.31	776	RR-30018
9.50	6.50	3.50	4.50	6.50	1.13	2 1/2-12	3.25	6.25	1 1/4-7	1.75	12 1/4-12	2.31	1034	RR-30024
9.50	6.50	3.50	4.50	6.50	1.13	2 1/2-12	3.25	6.25	1 1/4-7	1.75	12 1/4-12	2.31	1385	RR-30036
9.50	6.50	3.50	4.50	6.50	1.13	2 1/2-12	3.25	6.25	1 1/4-7	1.75	12 1/4-12	2.31	1720	RR-30048
11.00	7.50	4.25	5.25	7.50	1.13	3-12	3.75	8.00	1 1/2-6	2.00	14 1/8-8	2.56	670	RR-4006
11.00	7.50	4.25	5.25	7.50	1.13	3-12	3.75	8.00	1 1/2-6	2.00	14 1/8-8	2.56	880	RR-40012
11.00	7.50	4.25	5.25	7.50	1.13	3-12	3.75	8.00	1 1/2-6	2.00	14 1/8-8	2.56	1000	RR-40018
11.00	7.50	4.25	5.25	7.50	1.13	3-12	3.75	8.00	1 1/2-6	2.00	14 1/8-8	2.56	1317	RR-40024
11.00	7.50	4.25	5.25	7.50	1.13	3-12	3.75	8.00	1 1/2-6	2.00	14 1/8-8	2.56	1746	RR-40036
11.00	7.50	4.25	5.25	7.50	1.13	3-12	3.75	8.00	1 1/2-6	2.00	14 1/8-8	2.56	2162	RR-40048
12.00	8.00	4.75	6.00	8.00	1.13	3 1/4-12	4.25	8.00	1 3/4-5	2.12	15 5/8-8	3.13	953	RR-5006
12.00	8.00	4.75	6.00	8.00	1.13	3 1/4-12	4.25	8.00	1 3/4-5	2.12	15 5/8-8	3.13	1300	RR-50012
12.00	8.00	4.75	6.00	8.00	1.13	3 1/4-12	4.25	8.00	1 3/4-5	2.12	15 5/8-8	3.13	1500	RR-50018
12.00	8.00	4.75	6.00	8.00	1.13	3 1/4-12	4.25	8.00	1 3/4-5	2.12	15 5/8-8	3.13	1800	RR-50024
12.00	8.00	4.75	6.00	8.00	1.13	3 1/4-12	4.25	8.00	1 3/4-5	2.12	15 5/8-8	3.13	2210	RR-50036
12.00	8.00	4.75	6.00	8.00	1.13	3 1/4-12	4.25	8.00	1 3/4-5	2.12	15 5/8-8	3.13	2700	RR-50048

▼ HCL-1006, HCG-2006, HCR-506



Highest Level of Durability



The Summit Edition

Innovation is at the heart of the new *Summit Edition* of cylinders, delivering the high quality construction that you expect from Enerpac. The durability ensures your job gets done safely and reliably.

- Plunger support bearing adds support for eccentric loads ²⁾
- Nitrocarburization surface treatment for improved wear resistance and corrosion protection
- Replaceable composite bearings surround the seal providing support for eccentric loads
- Low-wear, high-pressure seals provide longer service life

²⁾ Eccentric load (or “side-load”) is inevitable in heavy lifting. Our unique Summit Edition features provide the ultimate protection against side-load. Increased bearing surface maintains stability, and nitrocarburization treatment prevents scoring on the inside of the cylinder. Side-load poses a real problem.... our new cylinder features are the solution!

Reaching the Summit Edition:

Substrate bonded multi-layer treatment

- Hardened surface resists side-loading and cyclic wear
- Weather protected, inside and out
- Low-friction locking rings spin easy, save time and effort ¹⁾

Enclosed polymer bearing system

- Upper and lower bearings enclose the cylinder plunger for support and are able to be replaced along with seals and other soft parts
- State-of-the-art bearing material provides maximum conformity to reduce wear and avoid bore damage even in high side-load conditions

Low-wear, high-pressure seals

- Improved geometry and material selection increases seal performance even in harsh conditions
- Low friction improves retraction times

Versatile

- Over 200 models in four configurations ¹⁾
- Certified lifting eyes, base mounting holes and collar threads are included for secure handling and cylinder mounting ¹⁾

¹⁾ See specific model's technical data for more information.

▼ *Bridge lifting and launching system. The load is balanced on groups of lock nut cylinders. The hydraulic movements are synchronized using the Enerpac PLC-controlled synchronous lift systems.*





High-Tonnage Cylinders

The Enerpac High-Tonnage Cylinders are particularly suitable for (multipoint) lifting applications.

In combination with our state-of-the-art power packs, you will have a world class hydraulic system to perform the most challenging lifting jobs in a safe and professional manner.

HCG, HCR, HCL-Series Cylinders

- 50 - 1000-ton lifting capacity
- 1.97 - 11.81 inch lifting stroke

HCG-Series - single-acting

- gravity-return
- stop-ring to prevent plunger blow-out
- designed to withstand up to 10% side-load of maximum capacity

HCR-Series - double-acting

- hydraulic advance and retract for controlled movement
- designed to withstand up to 10% side-load of maximum capacity

HCL-Series - lock nut, single-acting

- gravity-return
- lock nut for mechanical load holding
- overflow port to prevent plunger blow out
- designed to withstand 10% side-load up to 90% of maximum stroke

LPL-Series - lock nut, low height, single-acting

- 60 - 500-ton lifting capacity
- 1.77 - 1.97 inch lifting stroke
- integrated tilt saddle
- gravity-return
- lock nut for mechanical load holding
- 5-10% side-load of maximum capacity

Page: 5



HCG HCR HCL Series



Capacity:

50 - 1000 ton

Stroke:

1.77 - 11.81 inch.

Maximum Operating Pressure:

10,150 psi



Assisted-Return Pumps

Enerpac HCG, HCL and LPL-Series cylinders are hydraulic advance and gravity-return. To improve productivity and plunger retraction Enerpac offers assisted return on ZU4 and ZE-Series pumps featuring Enerpac Venturi valve technology, specifically to facilitate the faster return of single-acting, gravity-return cylinders. See enerpac.com for details.



Split-Flow Pumps

SFP-Series pumps with multiple outlets with equal oil flow. For lifting and lowering applications on multiple points, these pumps are a far better alternative than using separately operated pumps.

Page: 118



Synchronous Lifting Systems

Pumps for multiple lift-point capabilities. The economical **EVOB-Series** for basic applications and the multi-functional **EVO-Series** lifting system.

Page: 120



QUICK SELECTION

Cylinder Capacity (ton)	Stroke (in)	Maximum Cylinder Capacity at 10,150 psi (ton)	HCG-Series		HCR-Series		HCL-Series	
			Model Number Single-Acting <i>Page: 40</i>	Collapsed Height (in)	Model Number Double-Acting <i>Page: 44</i>	Collapsed Height (in)	Model Number Single-Acting With Lock Nut <i>Page: 48</i>	Collapsed Height (in)
50	1.97	62	HCG-502	7.20	HCR-502	7.20	HCL-502	6.46
	3.94		HCG-504	9.17	HCR-504	9.17	HCL-504	8.43
	5.91		HCG-506	11.14	HCR-506	11.14	HCL-506	10.39
	7.87		HCG-508	13.62	HCR-508	13.62	HCL-508	12.36
	9.84		HCG-5010	15.59	HCR-5010	15.59	HCL-5010	14.33
	11.81		HCG-5012	17.56	HCR-5012	17.56	HCL-5012	16.30
100	1.97	113	HCG-1002	7.95	HCR-1002	7.95	HCL-1002	7.36
	3.94		HCG-1004	9.92	HCR-1004	9.92	HCL-1004	9.33
	5.91		HCG-1006	11.89	HCR-1006	11.89	HCL-1006	11.30
	7.87		HCG-1008	14.92	HCR-1008	14.92	HCL-1008	13.27
	9.84		HCG-10010	16.89	HCR-10010	16.89	HCL-10010	15.24
	11.81		HCG-10012	18.86	HCR-10012	18.86	HCL-10012	17.20
150	1.97	168	HCG-1502	8.66	HCR-1502	8.66	HCL-1502	8.23
	3.94		HCG-1504	10.63	HCR-1504	10.63	HCL-1504	10.20
	5.91		HCG-1506	12.60	HCR-1506	12.60	HCL-1506	12.17
	7.87		HCG-1508	15.63	HCR-1508	15.63	HCL-1508	14.13
	9.84		HCG-15010	17.60	HCR-15010	17.60	HCL-15010	16.10
	11.81		HCG-15012	19.57	HCR-15012	19.57	HCL-15012	18.07
200	1.97	223	HCG-2002	9.09	HCR-2002	9.09	HCL-2002	9.37
	3.94		HCG-2004	11.06	HCR-2004	11.06	HCL-2004	11.34
	5.91		HCG-2006	13.03	HCR-2006	13.03	HCL-2006	13.31
	7.87		HCG-2008	16.06	HCR-2008	16.06	HCL-2008	15.28
	9.84		HCG-20010	18.03	HCR-20010	18.03	HCL-20010	17.24
	11.81		HCG-20012	20.00	HCR-20012	20.00	HCL-20012	19.21
250	1.97	286	HCG-2502	9.49	HCR-2502	9.49	HCL-2502	9.80
	3.94		HCG-2504	11.46	HCR-2504	11.46	HCL-2504	11.77
	5.91		HCG-2506	13.43	HCR-2506	13.43	HCL-2506	13.74
	7.87		HCG-2508	16.97	HCR-2508	16.97	HCL-2508	15.71
	9.84		HCG-25010	18.94	HCR-25010	18.94	HCL-25010	17.68
	11.81		HCG-25012	20.91	HCR-25012	20.91	HCL-25012	19.65
300	1.97	341	HCG-3002	11.65	HCR-3002	11.65	HCL-3002	10.94
	3.94		HCG-3004	13.62	HCR-3004	13.62	HCL-3004	12.91
	5.91		HCG-3006	15.59	HCR-3006	15.59	HCL-3006	14.88
	7.87		HCG-3008	17.56	HCR-3008	17.56	HCL-3008	16.85
	9.84		HCG-30010	19.53	HCR-30010	19.53	HCL-30010	18.82
	11.81		HCG-30012	21.50	HCR-30012	21.50	HCL-30012	20.79

Enerpac High-Tonnage Cylinders

Capacity:
50 - 1000 ton

Stroke:
1.97 - 11.81 inch

Maximum Operating Pressure:
10,150 psi

**HCG
HCR
HCL
Series**



QUICK SELECTION

Cylinder Capacity (ton)	Stroke (in)	Maximum Cylinder Capacity at 10,150 psi (ton)	HCG-Series		HCR-Series		HCL-Series	
			Model Number Single-Acting <i>Page: 40</i>	Collapsed Height (in)	Model Number Double-Acting <i>Page: 44</i>	Collapsed Height (in)	Model Number Single-Acting With Lock Nut <i>Page: 48</i>	Collapsed Height (in)
400	1.97	450	HCG-4002	12.64	HCR-4002	12.64	HCL-4002	12.48
	3.94		HCG-4004	14.61	HCR-4004	14.61	HCL-4004	14.45
	5.91		HCG-4006	16.57	HCR-4006	16.57	HCL-4006	16.42
	7.87		HCG-4008	18.54	HCR-4008	18.54	HCL-4008	18.39
	9.84		HCG-40010	20.51	HCR-40010	20.51	HCL-40010	20.35
	11.81		HCG-40012	22.48	HCR-40012	22.48	HCL-40012	22.32
500	1.97	575	HCG-5002	13.54	HCR-5002	13.54	HCL-5002	14.06
	3.94		HCG-5004	15.51	HCR-5004	15.51	HCL-5004	16.02
	5.91		HCG-5006	17.48	HCR-5006	17.48	HCL-5006	17.99
	7.87		HCG-5008	19.45	HCR-5008	19.45	HCL-5008	19.96
	9.84		HCG-50010	21.42	HCR-50010	21.42	HCL-50010	21.93
	11.81		HCG-50012	23.39	HCR-50012	23.39	HCL-50012	23.90
600	1.97	673	HCG-6002	13.86	HCR-6002	13.86	HCL-6002	14.96
	3.94		HCG-6004	15.83	HCR-6004	15.83	HCL-6004	16.93
	5.91		HCG-6006	17.80	HCR-6006	17.80	HCL-6006	18.90
	7.87		HCG-6008	19.76	HCR-6008	19.76	HCL-6008	20.87
	9.84		HCG-60010	21.73	HCR-60010	21.73	HCL-60010	22.83
	11.81		HCG-60012	23.70	HCR-60012	23.70	HCL-60012	24.80
800	1.97	916	HCG-8002	15.91	HCR-8002	15.91	HCL-8002	16.93
	3.94		HCG-8004	17.87	HCR-8004	17.87	HCL-8004	18.90
	5.91		HCG-8006	19.84	HCR-8006	19.84	HCL-8006	20.87
	7.87		HCG-8008	21.81	HCR-8008	21.81	HCL-8008	22.83
	9.84		HCG-80010	23.78	HCR-80010	23.78	HCL-80010	24.80
	11.81		HCG-80012	25.75	HCR-80012	25.75	HCL-80012	26.77
1000	1.97	1196	HCG-10002	17.40	HCR-10002	17.40	HCL-10002	19.06
	3.94		HCG-10004	19.37	HCR-10004	19.37	HCL-10004	21.02
	5.91		HCG-10006	21.34	HCR-10006	21.34	HCL-10006	22.99
	7.87		HCG-10008	23.31	HCR-10008	23.31	HCL-10008	24.96
	9.84		HCG-100010	25.28	HCR-100010	25.28	HCL-100010	26.93
	11.81		HCG-100012	27.24	HCR-100012	27.24	HCL-100012	28.90

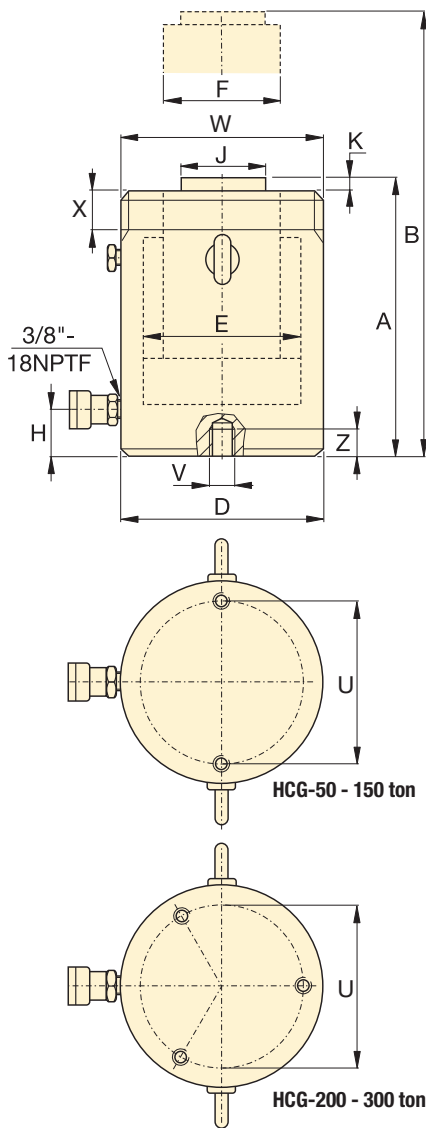

HCG-Series, Single-Acting, Gravity-Return Cylinders

- Hardened surface resists side-loading and cyclic wear
- Designed to withstand up to 10% side-load of maximum capacity 1)
- Stop-ring to prevent plunger blow-out
- Weather protected, inside and out
- Upper and lower replaceable bearings enclose the cylinder plunger for support throughout the stroke
- Certified lifting eyes, base mounting holes and collar threads

SELECTION CHART 50 – 300-TON HCG-MODELS

For 400 – 1000-ton models, see pages 42-43.

For full product features see pages 36-37.

Cylinder Capacity (ton)	Stroke (in)	Model Number	Maximum Cylinder Capacity at 10,150 psi (ton)	Cylinder Effective Area (in ²)	Oil Capacity (in ³)	Collapsed Height A (in)
50	1.97	HCG-502	62	12.17	23.96	7.20
	3.94	HCG-504			47.93	9.17
	5.91	HCG-506 1)			71.89	11.14
	7.87	HCG-508			95.86	13.62
	9.84	HCG-5010			119.82	15.59
	11.81	HCG-5012 1)			143.78	17.56
100	1.97	HCG-1002	113	22.19	43.67	7.95
	3.94	HCG-1004			87.35	9.92
	5.91	HCG-1006			131.02	11.89
	7.87	HCG-1008			174.70	14.92
	9.84	HCG-10010			218.37	16.89
	11.81	HCG-10012			262.05	18.86
150	1.97	HCG-1502	168	33.14	65.24	8.66
	3.94	HCG-1504			130.48	10.63
	5.91	HCG-1506			195.73	12.60
	7.87	HCG-1508			260.97	15.63
	9.84	HCG-15010			326.21	17.60
	11.81	HCG-15012			391.45	19.57
200	1.97	HCG-2002	223	43.95	86.51	9.09
	3.94	HCG-2004			173.02	11.06
	5.91	HCG-2006			259.53	13.03
	7.87	HCG-2008			346.04	16.06
	9.84	HCG-20010			432.55	18.03
	11.81	HCG-20012			519.06	20.00
250	1.97	HCG-2502	286	56.27	110.77	9.49
	3.94	HCG-2504			221.55	11.46
	5.91	HCG-2506			332.32	13.43
	7.87	HCG-2508			443.09	16.97
	9.84	HCG-25010			553.87	18.94
	11.81	HCG-25012			664.64	20.91
300	1.97	HCG-3002	341	67.23	132.34	11.65
	3.94	HCG-3004			264.68	13.62
	5.91	HCG-3006			397.02	15.59
	7.87	HCG-3008			529.36	17.56
	9.84	HCG-30010			661.71	19.53
	11.81	HCG-30012			794.05	21.50

Collar Thread (in)		
Model / Capacity (ton)	Thread Size W	Thread Length X
HCG-50	M130 x 2	1.18
HCG-100	M175 x 3	1.81
HCG-150	M215 x 3	2.17
HCG-200	M250 x 3	2.48
HCG-250	M280 x 3	2.52
HCG-300	M305 x 3	2.87

The collar thread length is designed for the full rated cylinder capacity.

Base Mounting Holes (in)					
Model / Capacity (ton)	Bolt Circle U	Thread Size V	Minimum Thread Depth Z	Number of Holes	Angle from Coupler
HCG-50	4.13	M12 x 1,75	0.87	2	90°
HCG-100	5.91	M12 x 1,75	0.87	2	90°
HCG-150	7.28	M12 x 1,75	0.87	2	90°
HCG-200	8.46	M12 x 1,75	0.87	3	60°
HCG-250	9.65	M12 x 1,75	0.87	3	60°
HCG-300	10.24	M16 x 2	0.98	3	60°

1) HCG-506 and HCG-5012: 7% side-load of maximum capacity.

Single-Acting, High-Tonnage Cylinders

Capacity:
50 - 300 ton

Stroke:
1.97 - 11.81 inch

Maximum Operating Pressure:
10,150 psi

HCG Series

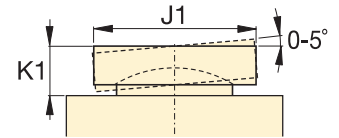

CATG-Series Tilt Saddle

	Extended Height	Outside Diameter	Cylinder Bore Diameter	Plunger Diameter	Base to Advance Port	Standard Saddle Diameter	Saddle Protusion from Plunger	Wt.	Model Number
	B (in)	D (in)	E (in)	F (in)	H (in)	J (in)	K (in)	(lbs)	
	9.17	5.12	3.94	2.76	1.50	1.97	0.12	37	HCG-502
	13.11							45	HCG-504
	17.05							53	HCG-506 ¹⁾
	21.50							64	HCG-508
	25.43							72	HCG-5010
	29.37							80	HCG-5012 ¹⁾
	9.92	6.89	5.31	3.74	1.50	2.95	0.12	73	HCG-1002
	13.86							88	HCG-1004
	17.80							102	HCG-1006
	22.80							128	HCG-1008
	26.73							142	HCG-10010
	30.67							157	HCG-10012 ¹⁾
	10.63	8.46	6.50	4.72	1.61	3.70	0.12	123	HCG-1502
	14.57							145	HCG-1504
	18.50							168	HCG-1506
	23.50							207	HCG-1508
	27.44							230	HCG-15010
	31.38							253	HCG-15012
	11.06	9.84	7.48	5.51	1.85	4.45	0.12	178	HCG-2002
	15.00							209	HCG-2004
	18.94							240	HCG-2006
	23.94							300	HCG-2008
	27.87							331	HCG-20010
	31.81							363	HCG-20012
	11.46	11.02	8.46	6.69	2.09	5.71	0.16	235	HCG-2502
	15.39							277	HCG-2504
	19.33							318	HCG-2506
	24.84							401	HCG-2508
	28.78							442	HCG-25010
	32.72							484	HCG-25012
	13.62	12.01	9.25	7.87	2.28	6.97	0.16	348	HCG-3002
	17.56							401	HCG-3004
	21.50							454	HCG-3006
	25.43							507	HCG-3008
	29.37							560	HCG-30010
	33.31							613	HCG-30012

Optional Tilt Saddle		
Diameter	Height	Saddle Model Number
J1 (in)	K1 (in)	
1.97	0.94	CATG-50
2.87	1.14	CATG-100
3.57	1.22	CATG-150
4.64	1.37	CATG-200
5.67	1.85	CATG-250
6.30	2.51	CATG-300

HCG-Series, Single-Acting, Gravity-Return Cylinders

- Hardened surface resists side-loading and cyclic wear
- Designed to withstand up to 10% side-load of maximum capacity
- Stop-ring to prevent plunger blow-out
- Weather protected, inside and out
- Upper and lower replaceable bearings enclose the cylinder plunger for support throughout the stroke
- Certified lifting eyes, base mounting holes and collar threads

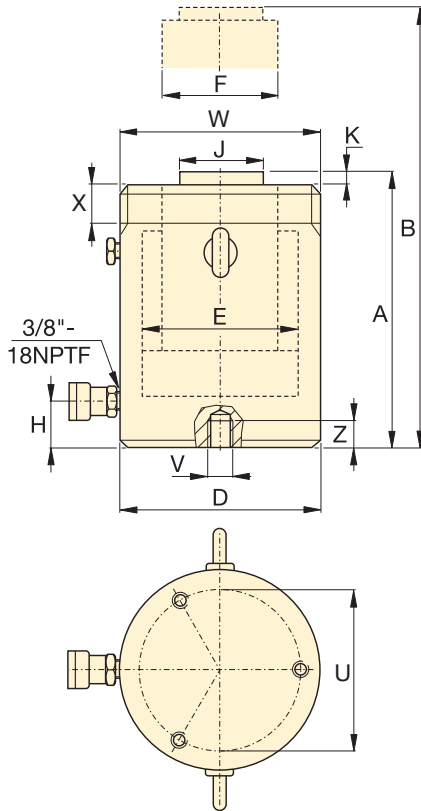

SELECTION CHART 400 – 1000-TON HCG-MODELS

For 50 – 300-ton models, see pages 40-41.

For full product features see pages 36-37.

Cylinder Capacity (ton)	Stroke (in)	Model Number	Maximum Cylinder Capacity at 10,150 psi (ton)	Cylinder Effective Area (in ²)	Oil Capacity (in ³)	Collapsed Height A (in)
400	1.97	HCG-4002	450	88.75	174.70	12.64
	3.94	HCG-4004			349.39	14.61
	5.91	HCG-4006			524.09	16.57
	7.87	HCG-4008			698.79	18.54
	9.84	HCG-40010			873.49	20.51
	11.81	HCG-40012			1,048.18	22.48
500	1.97	HCG-5002	575	113.25	222.92	13.54
	3.94	HCG-5004			445.85	15.51
	5.91	HCG-5006			668.77	17.48
	7.87	HCG-5008			891.70	19.45
	9.84	HCG-50010			1,114.62	21.42
	11.81	HCG-50012			1,337.55	23.39
600	1.97	HCG-6002	673	132.57	260.97	13.86
	3.94	HCG-6004			521.94	15.83
	5.91	HCG-6006			782.90	17.80
	7.87	HCG-6008			1,043.87	19.76
	9.84	HCG-60010			1,304.84	21.73
	11.81	HCG-60012			1,565.81	23.70
800	1.97	HCG-8002	916	180.44	355.21	15.91
	3.94	HCG-8004			710.41	17.87
	5.91	HCG-8006			1,065.62	19.84
	7.87	HCG-8008			1,420.82	21.81
	9.84	HCG-80010			1,776.03	23.78
	11.81	HCG-80012			2,131.24	25.75
1000	1.97	HCG-10002	1196	235.68	463.94	17.40
	3.94	HCG-10004			927.88	19.37
	5.91	HCG-10006			1,391.83	21.34
	7.87	HCG-10008			1,855.77	23.31
	9.84	HCG-100010			2,319.71	25.28
	11.81	HCG-100012			2,783.65	27.24

Collar Thread (in)		
Model / Capacity (ton)	Thread Size W	Thread Length X
HCG-400	M350 x 3	3.27
HCG-500	M400 x 4	3.54
HCG-600	M430 x 4	3.94
HCG-800	M505 x 5	4.80
HCG-1000	M570 x 5	5.39

The collar thread length is designed for the full rated cylinder capacity.

Base Mounting Holes (in)					
Model / Capacity (ton)	Bolt Circle U	Thread Size V	Minimum Thread Depth Z	Number of Holes	Angle from Coupler
HCG-400	11.81	M16 x 2	0.98	3	60°
HCG-500	13.39	M24 x 3	1.42	3	60°
HCG-600	14.57	M24 x 3	1.42	3	60°
HCG-800	17.32	M24 x 3	1.42	3	60°
HCG-1000	19.69	M24 x 3	1.42	3	60°

Single-Acting, High-Tonnage Cylinders



▲ Offshore wind turbine leveling: Enerpac's synchronous lifting system was the solution for leveling support cross pieces on 80 wind turbines.

HCG Series



Capacity:
400 - 1000 ton

Stroke:
1.97 - 11.81 inch

Maximum Operating Pressure:
10,150 psi

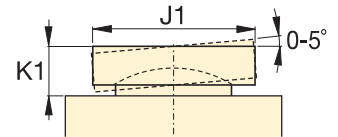

CATG-Series Tilt Saddle

Extended Height	Outside Diameter	Cylinder Bore Diameter	Plunger Diameter	Base to Advance Port	Standard Saddle Diameter	Saddle Protrusion from Plunger	Wt.	Model Number
B (in)	D (in)	E (in)	F (in)	H (in)	J (in)	K (in)	(lbs)	
14.61	13.78	10.63	8.66	2.91	7.72	0.16	500	HCG-4002
18.54							566	HCG-4004
22.48							633	HCG-4006
26.42							699	HCG-4008
30.35							766	HCG-40010
34.29							833	HCG-40012
15.51	15.75	12.01	9.84	3.11	8.98	0.16	704	HCG-5002
19.45							792	HCG-5004
23.39							880	HCG-5006
27.32							968	HCG-5008
31.26							1,056	HCG-50010
35.20							1,144	HCG-50012
15.83	16.93	12.99	10.63	3.35	9.72	0.16	834	HCG-6002
19.76							935	HCG-6004
23.70							1,036	HCG-6006
27.64							1,137	HCG-6008
31.57							1,239	HCG-60010
35.51							1,340	HCG-60012
17.87	19.88	15.16	12.60	3.94	11.69	0.16	1,336	HCG-8002
21.81							1,479	HCG-8004
25.75							1,621	HCG-8006
29.69							1,763	HCG-8008
33.62							1,905	HCG-80010
37.56							2,047	HCG-80012
19.37	22.44	17.32	13.39	4.49	12.72	0.16	1,852	HCG-10002
23.31							2,020	HCG-10004
27.24							2,188	HCG-10006
31.18							2,355	HCG-10008
35.12							2,523	HCG-100010
39.06							2,691	HCG-100012

Optional Tilt Saddle		
Diameter	Height	Saddle Model Number
J1 (in)	K1 (in)	
7.59	2.32	CATG-400
8.98	2.48	CATG-500
9.47	3.08	CATG-600
11.28	3.41	CATG-800
12.26	3.65	CATG-1000

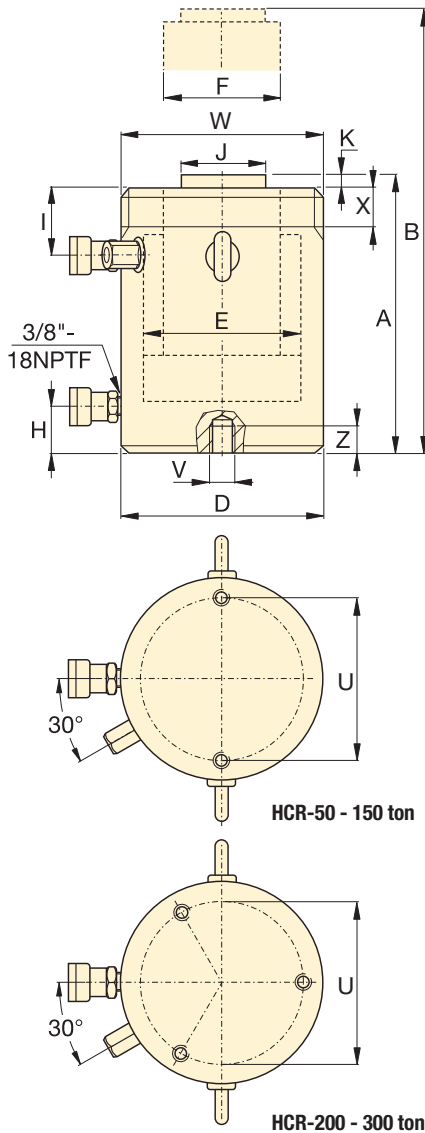

HCR-Series, Double-Acting Cylinders

- Fast advance and retract
- Designed to withstand up to 10% side-load of maximum capacity 1)
- Hardened surface resists side-loading and cyclic wear
- Weather protected, inside and out
- Upper and lower replaceable bearings enclose the cylinder plunger for support throughout the stroke
- Certified lifting eyes, base mounting holes and collar threads

SELECTION CHART AND DETAILS OF 50 – 300-TON HCR-MODELS

For 400 – 1000-ton models, see pages 46-47.

For full product features see pages 36-37

Cylinder Capacity (ton)	Stroke (in)	Model Number	Maximum Cylinder Capacity at 10,150 psi (ton)	Cylinder Effective Area (in ²)	Oil Capacity (in ³)	Collapsed Height A (in)
50	1.97	HCR-502	62	12.17	23.96	7.20
	3.94	HCR-504			47.93	9.17
	5.91	HCR-506 1)			71.89	11.14
	7.87	HCR-508			95.86	13.62
	9.84	HCR-5010			119.82	15.59
	11.81	HCR-5012 1)			143.78	17.56
100	1.97	HCR-1002	113	22.19	43.67	7.95
	3.94	HCR-1004			87.35	9.92
	5.91	HCR-1006			131.02	11.89
	7.87	HCR-1008			174.70	14.92
	9.84	HCR-10010			218.37	16.89
	11.81	HCR-10012			262.05	18.86
150	1.97	HCR-1502	168	33.14	65.24	8.66
	3.94	HCR-1504			130.48	10.63
	5.91	HCR-1506			195.73	12.60
	7.87	HCR-1508			260.97	15.63
	9.84	HCR-15010			326.21	17.60
	11.81	HCR-15012			391.45	19.57
200	1.97	HCR-2002	223	43.95	86.51	9.09
	3.94	HCR-2004			173.02	11.06
	5.91	HCR-2006			259.53	13.03
	7.87	HCR-2008			346.04	16.06
	9.84	HCR-20010			432.55	18.03
	11.81	HCR-20012			519.06	20.00
250	1.97	HCR-2502	286	56.27	110.77	9.49
	3.94	HCR-2504			221.55	11.46
	5.91	HCR-2506			332.32	13.43
	7.87	HCR-2508			443.09	16.97
	9.84	HCR-25010			553.87	18.94
	11.81	HCR-25012			664.64	20.91
300	1.97	HCR-3002	341	67.23	132.34	11.65
	3.94	HCR-3004			264.68	13.62
	5.91	HCR-3006			397.02	15.59
	7.87	HCR-3008			529.36	17.56
	9.84	HCR-30010			661.71	19.53
	11.81	HCR-30012			794.05	21.50

Collar Thread (in)		
Model / Capacity (ton)	Thread Size W	Thread Length X
HCR-50	M130 x 2	1.18
HCR-100	M175 x 3	1.81
HCR-150	M215 x 3	2.17
HCR-200	M250 x 3	2.48
HCR-250	M280 x 3	2.52
HCR-300	M305 x 3	2.87

The collar thread length is designed for the full rated cylinder capacity.

Base Mounting Holes (in)					
Model / Capacity (ton)	Bolt Circle U	Thread Size V	Minimum Thread Depth Z	No. of Holes	Angle from Coupler
HCR-50	4.13	M12 x 1,75	0.87	2	90°
HCR-100	5.91	M12 x 1,75	0.87	2	90°
HCR-150	7.28	M12 x 1,75	0.87	2	90°
HCR-200	8.46	M12 x 1,75	0.87	3	60°
HCR-250	9.65	M12 x 1,75	0.87	3	60°
HCR-300	10.24	M16 x 2	0.98	3	60°

1) HCR-506 and HCR-5012: 7% side-load of maximum capacity.

Double-Acting, High-Tonnage Cylinders

Capacity:
50 - 300 ton

Stroke:
1.97 - 11.81 inch

Maximum Operating Pressure:
10,150 psi

HCR Series

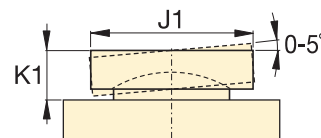

CATG-Series Tilt Saddle

	Extended Height	Outside Diameter	Cylinder Bore Diameter	Plunger Diameter	Base to Advance Port	Top to Retract Port	Standard Saddle Diameter	Saddle Protrusion from Plunger	Wt.	Model Number
	B (in)	D (in)	E (in)	F (in)	H (in)	I (in)	J (in)	K (in)	(lbs)	
	9.17	5.12	3.94	2.76	1.50	1.77	1.97	0.12	37	HCR-502
	13.11								46	HCR-504
	17.05								54	HCR-506 ¹⁾
	21.50					2.17			68	HCR-508
	25.43								76	HCR-5010
	29.37								84	HCR-5012 ¹⁾
	9.92	6.89	5.31	3.74	1.50	2.56	2.95	0.12	74	HCR-1002
	13.86								90	HCR-1004
	17.80								105	HCR-1006
	22.80					3.15			131	HCR-1008
	26.73								146	HCR-10010
	30.67								161	HCR-10012
	10.63	8.46	6.50	4.72	1.61	2.76	3.70	0.12	124	HCR-1502
	14.57								148	HCR-1504
	18.50								172	HCR-1506
	23.50					3.54			209	HCR-1508
	27.44								233	HCR-15010
	31.38								257	HCR-15012
	11.06	9.84	7.48	5.51	1.85	3.11	4.45	0.12	179	HCR-2002
	15.00								212	HCR-2004
	18.94								244	HCR-2006
	23.94					3.82			306	HCR-2008
	27.87								338	HCR-20010
	31.81								371	HCR-20012
	11.46	11.02	8.46	6.69	2.09	3.11	5.71	0.16	236	HCR-2502
	15.39								279	HCR-2504
	19.33								322	HCR-2506
	24.84					4.09			407	HCR-2508
	28.78								457	HCR-25010
	32.72								500	HCR-25012
	13.62	12.01	9.25	7.87	2.28	3.98	6.97	0.16	350	HCR-3002
	17.56								404	HCR-3004
	21.50								458	HCR-3006
	25.43					5.12			512	HCR-3008
	29.37								566	HCR-30010
	33.31								620	HCR-30012

Optional Tilt Saddle		
Diameter	Height	Saddle Model Number
J1 (in)	K1 (in)	
1.97	0.94	CATG-50
2.87	1.14	CATG-100
3.57	1.22	CATG-150
4.64	1.37	CATG-200
5.67	1.85	CATG-250
6.30	2.51	CATG-300

HCR-Series, Double-Acting Cylinders

- Fast advance and retract
- Designed to withstand up to 10% side-load of maximum capacity
- Hardened surface resists side-loading and cyclic wear
- Weather protected, inside and out
- Upper and lower replaceable bearings enclose the cylinder plunger for support throughout the stroke
- Certified lifting eyes, base mounting holes and collar threads

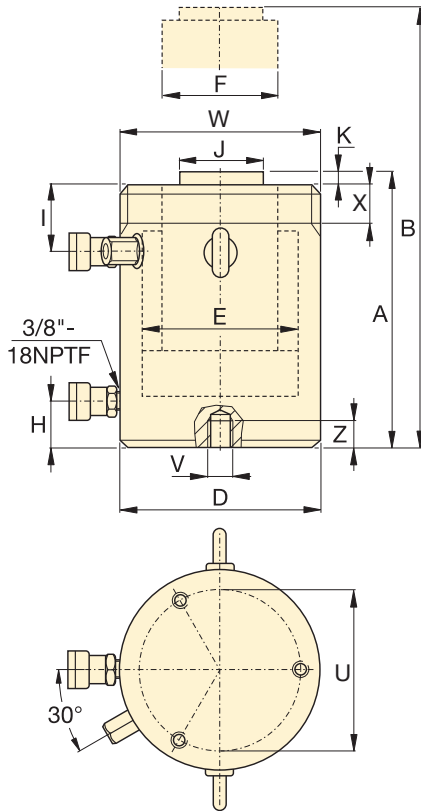

SELECTION CHART AND DETAILS OF 400 – 1000-TON HCR-MODELS

For 50 – 300-ton models, see pages 44-45.

For full product features see pages 36-37.

Cylinder Capacity (ton)	Stroke (in)	Model Number	Maximum Cylinder Capacity at 10,150 psi (ton)	Cylinder Effective Area (in ²)	Oil Capacity (in ³)	Collapsed Height A (in)
400	1.97	HCR-4002	450	88.75	174.70	12.64
	3.94	HCR-4004			349.39	14.61
	5.91	HCR-4006			524.09	16.57
	7.87	HCR-4008			698.79	18.54
	9.84	HCR-40010			873.49	20.51
	11.81	HCR-40012			1,048.18	22.48
500	1.97	HCR-5002	575	113.25	222.92	13.54
	3.94	HCR-5004			445.85	15.51
	5.91	HCR-5006			668.77	17.48
	7.87	HCR-5008			891.70	19.45
	9.84	HCR-50010			1,114.62	21.42
	11.81	HCR-50012			1,337.55	23.39
600	1.97	HCR-6002	673	132.57	260.97	13.86
	3.94	HCR-6004			521.94	15.83
	5.91	HCR-6006			782.90	17.80
	7.87	HCR-6008			1,043.87	19.76
	9.84	HCR-60010			1,304.84	21.73
	11.81	HCR-60012			1,565.81	23.70
800	1.97	HCR-8002	916	180.44	355.21	15.91
	3.94	HCR-8004			710.41	17.87
	5.91	HCR-8006			1,065.62	19.84
	7.87	HCR-8008			1,420.82	21.81
	9.84	HCR-80010			1,776.03	23.78
	11.81	HCR-80012			2,131.24	25.75
1000	1.97	HCR-10002	1196	235.68	463.94	17.40
	3.94	HCR-10004			927.88	19.37
	5.91	HCR-10006			1,391.83	21.34
	7.87	HCR-10008			1,855.77	23.31
	9.84	HCR-100010			2,319.71	25.28
	11.81	HCR-100012			2,783.65	27.24

Collar Thread (in)		
Model / Capacity (ton)	Thread Size W	Thread Length X
HCR-400	M350 x 3	3.27
HCR-500	M400 x 4	3.54
HCR-600	M430 x 4	3.94
HCR-800	M505 x 5	4.80
HCR-1000	M570 x 5	5.39

The collar thread length is designed for the full rated cylinder capacity.

Base Mounting Holes (in)					
Model / Capacity (ton)	Bolt Circle U	Thread Size V	Min. Thread Depth Z	Number of Holes	Angle from Coupler
HCR-400	11.81	M16 x 2	0.98	3	60°
HCR-500	13.39	M24 x 3	1.42	3	60°
HCR-600	14.57	M24 x 3	1.42	3	60°
HCR-800	17.32	M24 x 3	1.42	3	60°
HCR-1000	19.69	M24 x 3	1.42	3	60°

Double-Acting, High-Tonnage Cylinders



▲ The superlifting and launch of a 43,000 ton floating oil production system in Malaysia for the Gumusut-Kakap offshore field has set high benchmarks for safety through its use of sophisticated EVO-Series synchronous hydraulics to lift, balance, weigh and smoothly launch massive resource structures.

HCR Series



Capacity:
400 - 1000 ton

Stroke:
1.97 - 11.81 inch

Maximum Operating Pressure:
10,150 psi

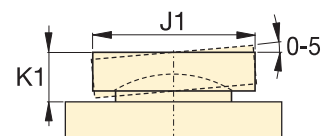

CATG-Series Tilt Saddle

Extended Height	Outside Diameter	Cylinder Bore Diameter	Plunger Diameter	Base to Advance Port	Top to Retract Port	Standard Saddle Diameter	Saddle Protrusion from Plunger	Wt. (lbs)	Model Number	Optional Tilt Saddle			
										Diameter J1 (in)	Height K1 (in)	Saddle Model Number	
14.61	13.78	10.63	8.66	2.91	4.37	7.72	0.16	501	HCR-4002	7.59	2.32	CATG-400	
18.54								570					HCR-4004
22.48								638					HCR-4006
26.42								707					HCR-4008
30.35								775					HCR-40010
34.29								843					HCR-40012
15.51	15.75	12.01	9.84	3.11	4.76	8.98	0.16	706	HCR-5002	8.98	2.48	CATG-500	
19.45								797					HCR-5004
23.39								887					HCR-5006
27.32								977					HCR-5008
31.26								1,067					HCR-50010
35.20								1,158					HCR-50012
15.83	16.93	12.99	10.63	3.35	4.76	9.72	0.16	836	HCR-6002	9.47	3.08	CATG-600	
19.76								940					HCR-6004
23.70								1,044					HCR-6006
27.64								1,148					HCR-6008
31.57								1,252					HCR-60010
35.51								1,356					HCR-60012
17.87	19.88	15.16	12.60	3.94	5.63	11.69	0.16	1,340	HCR-8002	11.28	3.41	CATG-800	
21.81								1,485					HCR-8004
25.75								1,631					HCR-8006
29.69								1,777					HCR-8008
33.62								1,922					HCR-80010
37.56								2,068					HCR-80012
19.37	22.44	17.32	13.39	4.49	6.02	12.72	0.16	1,858	HCR-10002	12.26	3.65	CATG-1000	
23.31								2,031					HCR-10004
27.24								2,205					HCR-10006
31.18								2,379					HCR-10008
35.12								2,552					HCR-100010
39.06								2,726					HCR-100012

HCL-Series, Single-Acting, Gravity-Return Cylinders

- Lock nut provides positive and safe mechanical load holding
- Low-friction locking rings spin easy, save time and effort
- Designed to withstand 10% side-load up to 90% of maximum stroke
- Hardened surface resists side-loading and cyclic wear
- Overflow port as stroke limiter to prevent plunger blow-out
- Weather protected, inside and out
- Replaceable bearings enclose the plunger for support throughout the stroke
- Certified lifting eyes and base mounting holes

SELECTION CHART 50 – 300-TON HCL-MODELS

For 400 – 1000-ton models, see pages 50-51.

For full product features see pages 36-37.

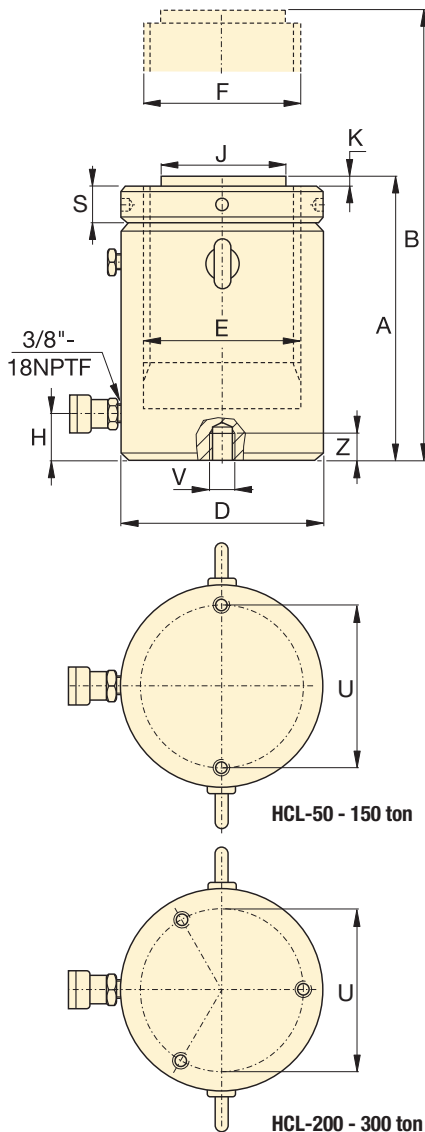

Base Mounting Holes (in)					
Model / Capacity (ton)	Bolt Circle U	Thread Size V	Minimum Thread Depth Z	Number of Holes	Angle from Coupler
HCL-50	4.13	M8X1.25	0.39	2	90°
HCL-100	5.91	M12X1.75	0.67	2	90°
HCL-150	7.28	M12X1.75	0.87	2	90°
HCL-200	8.46	M12X1.75	0.87	3	60°
HCL-250	9.65	M12X1.75	0.87	3	60°
HCL-300	10.24	M16X2	0.98	3	60°

Cylinder Capacity (ton)	Stroke (in)	Model Number	Maximum Cylinder Capacity at 10,150 psi (ton)	Cylinder Effective Area (in ²)	Oil Capacity (in ³)	Collapsed Height A (in)
50	1.97	HCL-502	62	12.17	23.96	6.46
	3.94	HCL-504			47.93	8.43
	5.91	HCL-506			71.89	10.39
	7.87	HCL-508			95.86	12.36
	9.84	HCL-5010			119.82	14.33
	11.81	HCL-5012			143.78	16.30
100	1.97	HCL-1002	113	22.19	43.67	7.36
	3.94	HCL-1004			87.35	9.33
	5.91	HCL-1006			131.02	11.30
	7.87	HCL-1008			174.70	13.27
	9.84	HCL-10010			218.37	15.24
	11.81	HCL-10012			262.05	17.20
150	1.97	HCL-1502	168	33.14	65.24	8.23
	3.94	HCL-1504			130.48	10.20
	5.91	HCL-1506			195.73	12.17
	7.87	HCL-1508			260.97	14.13
	9.84	HCL-15010			326.21	16.10
	11.81	HCL-15012			391.45	18.07
200	1.97	HCL-2002	223	43.95	86.51	9.37
	3.94	HCL-2004			173.02	11.34
	5.91	HCL-2006			259.53	13.31
	7.87	HCL-2008			346.04	15.28
	9.84	HCL-20010			432.55	17.24
	11.81	HCL-20012			519.06	19.21
250	1.97	HCL-2502	286	56.27	110.77	9.80
	3.94	HCL-2504			221.55	11.77
	5.91	HCL-2506			332.32	13.74
	7.87	HCL-2508			443.09	15.71
	9.84	HCL-25010			553.87	17.68
	11.81	HCL-25012			664.64	19.65
300	1.97	HCL-3002	341	67.23	132.34	10.94
	3.94	HCL-3004			264.68	12.91
	5.91	HCL-3006			397.02	14.88
	7.87	HCL-3008			529.36	16.85
	9.84	HCL-30010			661.71	18.82
	11.81	HCL-30012			794.05	20.79

Single-Acting, High-Tonnage Lock Nut Cylinders

Capacity:
50 - 300 ton

Stroke:
1.97 - 11.81 inch

Maximum Operating Pressure:
10,150 psi

HCL Series

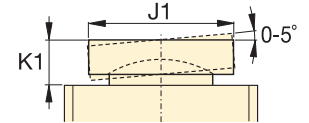

CAT-Series Tilt Saddle

	Extended Height	Outside Diameter	Cylinder Bore Diameter	Plunger Diameter	Base to Advance Port	Standard Saddle Diameter	Saddle Protrusion from Plunger	Lock Nut Height	Wt.	Model Number	Optional Tilt Saddle		
											Diameter	Height	Saddle Model Number
	B (in)	D (in)	E (in)	F (mm)	H (in)	J (in)	K (in)	S (in)	(lbs)		J1 (in)	K1 (in)	
	8.43	5.12	3.94	Tr 100 x 4	0.94	2.80	0.08	0.98	37	HCL-502	2.80	0.93	CAT-100
	12.36								48	HCL-504			
	16.30								60	HCL-506			
	20.24								71	HCL-508			
	24.17								83	HCL-5010			
	28.11								94	HCL-5012			
	9.33	6.89	5.31	Tr 135 x 6	1.30	2.80	0.08	1.30	77	HCL-1002	2.80	0.93	CAT-100
	13.27								98	HCL-1004			
	17.20								118	HCL-1006			
	21.14								139	HCL-1008			
	25.08								160	HCL-10010			
	29.02								181	HCL-10012			
	10.20	8.46	6.50	Tr 165 x 6	1.61	5.12	0.08	1.57	130	HCL-1502	5.12	0.76	CAT-200
	14.13								161	HCL-1504			
	18.07								192	HCL-1506			
	22.01								224	HCL-1508			
	25.94								255	HCL-15010			
	29.88								287	HCL-15012			
	11.34	9.84	7.48	Tr 190 x 6	1.85	5.12	0.08	1.77	188	HCL-2002	5.12	0.76	CAT-200
	15.28								231	HCL-2004			
	19.21								273	HCL-2006			
	23.15								316	HCL-2008			
	27.09								358	HCL-20010			
	31.02								401	HCL-20012			
	11.77	11.02	8.46	Tr 215 x 6	2.09	5.91	0.08	2.05	262	HCL-2502	5.91	0.76	CAT-250
	15.71								316	HCL-2504			
	19.65								369	HCL-2506			
	23.58								422	HCL-2508			
	27.52								476	HCL-25010			
	31.46								529	HCL-25012			
	12.91	12.01	9.25	Tr 235 x 6	2.28	5.49	0.08	2.20	348	HCL-3002	7.68	2.86	CAT-300
	16.85								411	HCL-3004			
	20.79								474	HCL-3006			
	24.72								537	HCL-3008			
	28.66								601	HCL-30010			
	32.60								664	HCL-30012			

HCL-Series, Single-Acting, Gravity-Return Cylinders

- Lock nut provides positive and safe mechanical load holding
- Low-friction locking rings spin easy, save time and effort
- Designed to withstand 10% side-load up to 90% of maximum stroke
- Hardened surface resists side-loading and cyclic wear
- Overflow port as stroke limiter to prevent plunger blow-out
- Weather protected, inside and out
- Replaceable bearings enclose the plunger for support throughout the stroke
- Certified lifting eyes and base mounting holes

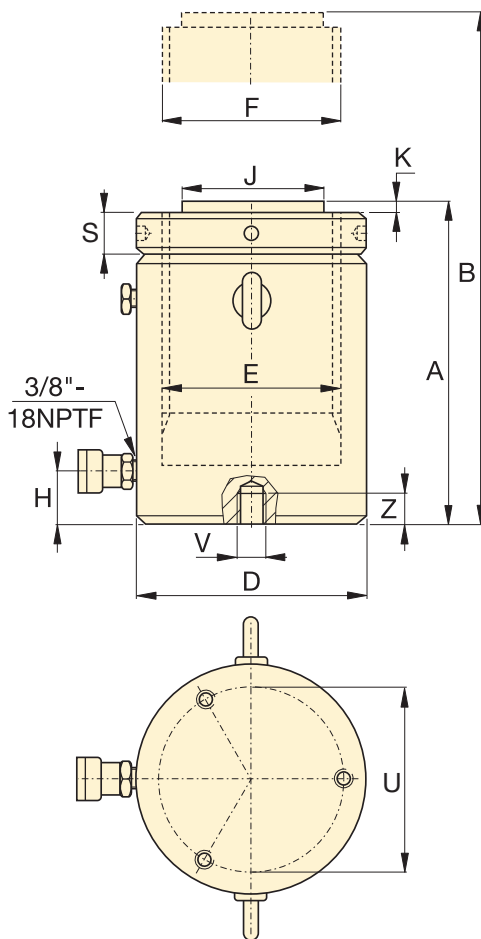

SELECTION CHART 400 – 1000-TON HCL-MODELS

For 50 – 300-ton models, see pages 48-49

For full product features see pages 36-37.

Cylinder Capacity (ton)	Stroke (in)	Model Number	Maximum Cylinder Capacity at 10,150 psi (ton)	Cylinder Effective Area (in ²)	Oil Capacity (in ³)	Collapsed Height A (in)
400	1.97	HCL-4002	450	88.75	174.70	12.48
	3.94	HCL-4004			349.39	14.45
	5.91	HCL-4006			524.09	16.42
	7.87	HCL-4008			698.79	18.39
	9.84	HCL-40010			873.49	20.35
	11.81	HCL-40012			1,048.18	22.32
500	1.97	HCL-5002	575	113.25	222.92	14.06
	3.94	HCL-5004			445.85	16.02
	5.91	HCL-5006			668.77	17.99
	7.87	HCL-5008			891.70	19.96
	9.84	HCL-50010			1,114.62	21.93
	11.81	HCL-50012			1,337.55	23.90
600	1.97	HCL-6002	673	132.57	260.97	14.96
	3.94	HCL-6004			521.94	16.93
	5.91	HCL-6006			782.90	18.90
	7.87	HCL-6008			1,043.87	20.87
	9.84	HCL-60010			1,304.84	22.83
	11.81	HCL-60012			1,565.81	24.80
800	1.97	HCL-8002	916	180.44	355.21	16.93
	3.94	HCL-8004			710.41	18.90
	5.91	HCL-8006			1,065.62	20.87
	7.87	HCL-8008			1,420.82	22.83
	9.84	HCL-80010			1,776.03	24.80
	11.81	HCL-80012			2,131.24	26.77
1000	1.97	HCL-10002	1196	235.68	463.94	19.06
	3.94	HCL-10004			927.88	21.02
	5.91	HCL-10006			1,391.83	22.99
	7.87	HCL-10008			1,855.77	24.96
	9.84	HCL-100010			2,319.71	26.93
	11.81	HCL-100012			2,783.65	28.90

Base Mounting Holes (in)					
Model / Capacity (ton)	Bolt Circle U	Thread Size V	Minimum Thread Depth Z	Number of Holes	Angle from Coupler
HCL-400	11.81	M16 x 2	0.95	3	60°
HCL-500	13.39	M24 x 3	1.42	3	60°
HCL-600	14.57	M24 x 3	1.42	3	60°
HCL-800	17.32	M24 x 3	1.42	3	60°
HCL-1000	19.69	M24 x 3	1.42	3	60°

Single-Acting, High Tonnage, Lock Nut Cylinders



▲ Heavy lifting and foundation levelling. The lock nut provides mechanical load holding over a long period of time.

HCL Series



Capacity:
400 - 1000 ton

Stroke:
1.97 - 11.81 inch

Maximum Operating Pressure:
10,150 psi

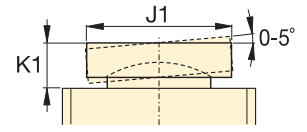

CAT-Series Tilt Saddle

Extended Height	Outside Diameter	Cylinder Bore Diameter	Plunger Diameter	Base to Advance Port	Standard Saddle Diameter	Saddle Protrusion from Plunger	Lock Nut Height	Wt.	Model Number	Optional Tilt Saddle		
										Diameter	Height	Saddle Model Number
B (in)	D (in)	E (in)	F (mm)	H (in)	J (in)	K (in)	S (in)	(lbs)		J1 (in)	K1 (in)	
14.45	13.78	10.63	Tr 270 x 6	2.64	6.27	0.20	2.56	520	HCL-4002	8.86	3.34	CAT-400
18.39								603	HCL-4004			
22.32								686	HCL-4006			
26.26								770	HCL-4008			
30.20								853	HCL-40010			
34.13								936	HCL-40012			
16.02	15.75	12.01	Tr 305 x 6	2.95	7.06	0.20	2.83	751	HCL-5002	9.84	3.57	CAT-500
19.96								860	HCL-5004			
23.90								968	HCL-5006			
27.83								1,077	HCL-5008			
31.77								1,186	HCL-50010			
35.71								1,294	HCL-50012			
16.93	16.93	12.99	Tr 330 x 6	3.19	7.65	0.20	3.15	942	HCL-6002	10.83	3.89	CAT-600
20.87								1,067	HCL-6004			
24.80								1,193	HCL-6006			
28.74								1,319	HCL-6008			
32.68								1,444	HCL-60010			
36.61								1,570	HCL-60012			
18.90	19.88	15.16	Tr 385 x 6	3.74	8.83	0.20	3.54	1,472	HCL-8002	12.60	4.89	CAT-800
22.83								1,646	HCL-8004			
26.77								1,819	HCL-8006			
30.71								1,992	HCL-8008			
34.65								2,166	HCL-80010			
38.58								2,339	HCL-80012			
21.02	22.44	17.32	Tr 440 x 6	4.33	9.81	0.20	4.13	2,115	HCL-10002	14.17	5.36	CAT-1000
24.96								2,335	HCL-10004			
28.90								2,556	HCL-10006			
32.83								2,777	HCL-10008			
36.77								2,998	HCL-100010			
40.71								3,219	HCL-100012			

▼ Shown cylinder-pump set: **SCR-1010H**



The Quickest and Easiest Way to Start Working Right Away



LW-16 Lifting Wedge

Hydraulic cylinders, jacks and lifting wedges can also be used to assist in positioning and aligning.



The LW-16 only requires an access gap of .39 inch. See our "Specialty Tools" section on www.enerpac.com.

Page: 192

- Optimum match of individual components
- All sets are ready to use and include single-acting cylinder, two-speed pump, 6-foot safety hose, calibrated gauge with gauge adaptor
- RC-Series DUO, general purpose cylinders for maximum versatility
- RCS-Series, low-height cylinders for maximum versatility
- RCH-Series hollow cylinders for pushing and pulling

▼ Cylinder-Pump Sets - optimum match of components. The quickest and easiest way to start working right away.



1 Cylinder Selection	Nominal Set Capacity (ton)	Cylinder Model No.	Stroke (in)	Collapsed Height (in)
	5	RC-55	5.00	8.50
	10	RC-102	2.13	4.78
		RC-106	6.13	9.75
		RC-1010	10.13	13.75
	15	RC-154	4.00	7.88
		RC-156	6.00	10.69
25	RC-252	2.00	6.50	
	RC-254	4.00	8.50	
	RC-256	6.25	10.75	
	RC-2514	14.25	18.75	
50	RC-506	6.25	11.13	
	10	RCS-101	1.50	3.47
	20	RCS-201	1.75	3.88
	30	RCS-302	2.44	4.63
	50	RCS-502	2.38	4.81
	100	RCS-1002	2.25	5.56
	12	RCH-121	1.63	4.75
	20	RCH-202	2.00	6.31
	30	RCH-302	2.50	7.03
	60	RCH-603	3.00	9.75
	100	RCH-1003	3.00	10.00

Single-Acting, Cylinder Pump Sets

SELECTION EXAMPLE

Selected cylinder:

- RC-106, Single-acting cylinder with 6.13" stroke

Selected pump:

- P-392, Lightweight hand pump

Set model number:

- SCR-106H

Included:

- HC-7206 hose
- GF-10P gauge
- GA-2 adaptor



GA45GC Gauge Adaptor³⁾

Protect yourself from system overloading by simply ordering one part number for a pre-assembled gauge, adaptor block and coupler.

Page: 144

SC Series



Capacity:

5-100 tons

Stroke:

1.50-14.25 inches

Maximum Operating Pressure:

10,000 psi

SET SELECTION:

- 1 Select the cylinder
- 2 Select the pump
- 3 Find the set model number in the gray field of the matrix

2

Pump selection (See Pump Section of this catalog for full product descriptions)

Accessories Included

Hand Pump P-142	Hand Pump P-392	Hand Pump P-80	Foot Pump P-392FP	XA-Series Air Pump XA-11	XC-Series Cordless Pump ²⁾ XC-1202MB	Hose Model No.	Gauge Model No.	Gauge Adaptor Model No.
SCR-55H	-	-	-	-	-	HC-7206	GP-10S	GA-4
-	SCR-102H	-	SCR-102FP	SCR-102XA	SCR-102XCB	HC-7206	GF-10P	GA-2
-	SCR-106H	-	SCR-106FP	SCR-106XA	SCR-106XCB	HC-7206	GF-10P	GA-2
-	SCR-1010H	-	SCR-1010FP	SCR-1010XA	SCR-1010XCB	HC-7206	GF-10P	GA-2
-	SCR-154H	-	SCR-154FP	SCR-154XA	SCR-154XCB	HC-7206	GP-10S	GA-2
-	SCR-156H	-	SCR-156FP	SCR-156XA	SCR-156XCB	HC-7206	GP-10S	GA-2
-	SCR-252H	-	SCR-252FP	SCR-252XA	SCR-252XCB	HC-7206	GF-20P	GA-2
-	SCR-254H	-	SCR-254FP	SCR-254XA	SCR-254XCB	HC-7206	GF-20P	GA-2
-	SCR-256H	-	-	SCR-256XA	SCR-256XCB	HC-7206	GF-20P	GA-2
-	-	SCR-2514H	-	SCR-2514XA ¹⁾	-	HC-7206	GF-20P	GA-2
-	-	SCR-506H	-	SCR-506XA ¹⁾	-	HC-7206	GF-50P	GA-2
-	SCL-101H	-	SCL-101FP	SCL-101XA	-	HC-7206	GF-10P	GA-2
-	SCL-201H	-	SCL-201FP	SCL-201XA	-	HC-7206	GF-230P	GA-2
-	SCL-302H	-	SCL-302FP	SCL-302XA	SCL-302XCB	HC-7206	GF-230P	GA-2
-	SCL-502H	-	SCL-502FP	SCL-502XA	SCL-502XCB	HC-7206	GF-510P	GA-2
-	-	SCL-1002H	-	-	SCL-1002XCB	HC-7206	GF-510P	GA-2
SCH-121H	-	-	-	-	-	HB-7206	GF-120P	GA-4
-	SCH-202H	-	SCH-202FP	SCH-202XA	SCH-202XCB	HC-7206	GF-813P	GA-3
-	SCH-302H	-	SCH-302FP	SCH-302XA	SCH-302XCB	HC-7206	GF-813P	GA-3
-	-	SCH-603H	-	SCH-603XA ¹⁾	SCH-603XCB	HC-7206	GF-813P	GA-3
-	-	SCH-1003H	-	-	-	HC-7206	GP-10S	GA-2

¹⁾ With XA-12 air pump

²⁾ XC Cordless Pump includes 115 V charger, for 230 V charger replace the "B" in the model number with an "E".

³⁾ XC Pump Sets include only the HC-7206 Hose and GA45GC Gauge Adaptor accessories

▼ Shown from left to right: P-142ALSS, P-392ALSS, V-152NV, V-66NV, RC256NV, RC-106NV, RC-53NV



RC, P, V Series

Cylinder Capacity:
5-25 tons

Stroke:
2-6 inches

Maximum Operating Pressure:
10,000 psi



Applications

Use Enerpac **Extreme Environment Products** in wet environments such as food processing, pulp and paper, mining, construction and applications in high temperature or in welding areas.

- Corrosion resistant, nickel-plated valves and cylinders
- Stainless steel pump inserts will not corrode
- Viton® Seals provide heat and chemical resistance
- Anodized aluminum pump reservoirs and plastic encapsulated pump bodies resist wet environments
- Two-speed operation reduces pump handle strokes 78% compared to single-speed pumps
- Pump handles lock for easy carrying



Multifluid Hand Pumps

MP-Series corrosion resistant hand pumps for low pressure filling and high pressure testing applications, suitable for a wide range of fluids.

Page: **77**

▼ CYLINDER CHART



Cylinder Capacity	Stroke	Model Number *	Oil Capacity	Pressure Rating	Collapsed Height	Extended Height	Outside Diameter	Weight
(ton)	(in)		(in ³)	(psi)	(in)	(in)	(in)	(lbs)
5	3.0	RC-53NV	2.98	10,000	6.50	9.50	1.50	3.3
10	2.0	RC-102NV	4.75	10,000	4.78	6.91	2.25	5.1
10	6.0	RC-106NV	13.70	10,000	9.75	15.88	2.25	9.8
25	6.0	RC-256NV	32.23	10,000	10.75	17.00	3.38	22.0

▼ HAND PUMP CHART



Pump Type	Oil Capacity	Model Number *	Pressure Rating	Oil Displacement per Stroke	Port Dimension	Piston Stroke	Weight
	(in ³)		(psi)	(in ³)	(in)	(in)	(lbs)
Two Speed	20	P-142ALSS	200/10,000	0.221 / 0.055	1/4"-18 NPTF	.50	4.5
	55	P-392ALSS	200/10,000	0.687 / 0.151	3/8"-18 NPTF	1.00	9.0

▼ VALVE CHART



Valve Type	Model Number *	Pressure Function	Pressure Rating (psi)	Weight (lbs)
Manual Check Valve	V-66NV	Check	10,000	4.5
Pressure Relief Valve	V-152NV	+ 3% Repeatability	800-10,000	9.0

* For cylinder details see pages 7-9; for pump details see pages 70-71; for valve details see pages 146-147.

Portable Hydraulic Toolbox

▼ Shown: SCR106TB



- Includes a single-acting cylinder, two-speed lightweight hand pump (P392), gauge adaptor assembly (GA45GC), and 6 ft. rubber hose with couplers (HC9206C)
- Complete and ready-to-use hydraulic system
- Easy to carry sturdy toolbox
- All components ship inside the toolbox as one package

SCR, SCL, SRS Series

Capacity:
5-50 tons

Stroke:
.44- 10.13 inches

Maximum Operating Pressure:
10,000 psi







Gauge Adaptor Assembly

Toolbox sets include a 45 degree angled gauge adaptor assembly for improved operating ergonomics and safety.

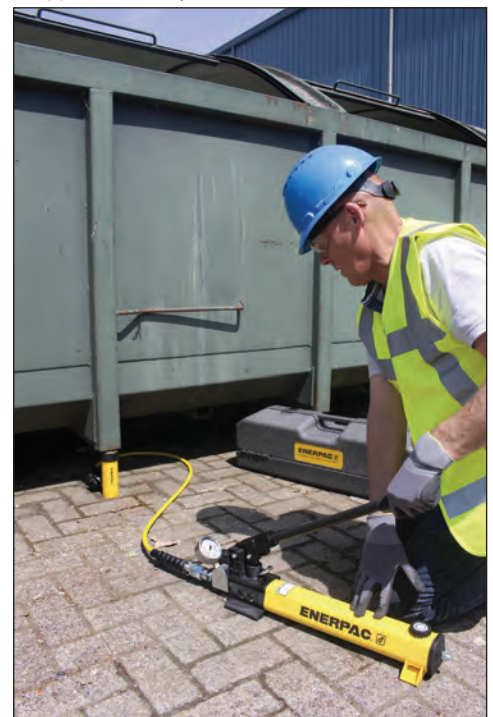
Page: 144

▼ The Hydraulic Toolbox is a versatile tool and applicable everywhere.



	Cylinder Model	Stroke (in)	Capacity (tons)	Weight (lbs)	Toolbox Set Model Number
 RC Series	General Purpose Cylinders				
	RC-55	5.00	5	26	SCR-55TB
	RC-102	2.13	10	27	SCR-102TB
	RC-106	6.13	10	32	SCR-106TB
	RC-1010	10.13	10	36	SCR-1010TB
	RC-154	4.00	15	34	SCR-154TB
	RC-256	6.25	25	45	SCR-256TB
 RCS Series	Low-Height Cylinders				
	RCS-101	1.50	10	28	SCL-101TB
	RCS-201	1.75	20	33	SCL-201TB
	RCS-302	2.44	30	37	SCL-302TB
	RCS-502	2.38	50	44	SCL-502TB
 RSM Series	Flat-Jac® Cylinders				
	RSM-100	0.44	10	26	SRS-100TB
	RSM-200	0.44	20	28	SRS-200TB
	RSM-300	0.50	30	31	SRS-300TB
	RSM-500	0.63	50	37	SRS-500TB

▼ Shown from left to right: JHA-356, JHA-156



JH, JHA Series

Capacity:
7-150 tons

Stroke:
3.00-6.13 inches

Maximum Operating Pressure:
10,000 psi

- All-directional operation on 7, 15 and 35-ton models (JHA- Series)
- Internal relief valve to prevent overloading
- Machined flat front and bottom surfaces permit flush alignment in tight corners
- All models include pumping handle
- Chrome-plated plungers
- Automatic by-pass port to prevent over-extension (JH-Series)



Lifting Wedge and Machine Lifts

Ideal to lift the load the first few inches. The **LW-16** Lifting Wedge requires a very small access gap of only .39 inch.

Page: 192



Load Skates

For moving heavy loads easily and safely.

Page: 194

Style	Jack Capacity (ton)	Stroke (in)	Model Number	Jack Effective Area (in ²)	Collapsed Height (in)	Extended Height (in)	Bottom Plate Dimensions (W x L) (in)	Plunger Diameter (in)	Pump Speed	Weight (lbs)
Aluminum Jack	7	3.00	JHA-73	1.49	5.25	8.25	2.88 x 6.25	1.19	Single	11
	15	6.06	JHA-156	3.14	9.75	15.81	3.63 x 9.38	1.63	Single	29
	35	6.13	JHA-356	7.07	10.13	16.25	4.63 x 10.00	2.13	Single	40
	75	6.06	JHA-756	15.90	11.25	17.31	6.88 x 12.81	4.50	Single	94
	150	6.13	JHA-1506	30.68	12.88	19.00	9.50 x 16.06	6.25	2-Speed	210
Steel Jack	30	6.13	JH-306	5.94	10.00	16.13	3.75 x 9.56	2.75	Single	59
	50	6.09	JH-506	9.62	10.25	16.34	5.00 x 10.19	3.50	2-Speed	90
	100	6.06	JH-1006	20.63	11.31	17.37	7.13 x 12.94	5.12	2-Speed	184

▼ Shown: GBJ-010, GBJ-030, GBJ-003



- Lower handle effort reduces operator fatigue
- Fully serviceable
- High-strength beam and pump linkage for long life
- Pumping handle included on all models
- Safety relief valve to prevent overload
- Automatic by-pass port to prevent over-extension
- Wiper seal for extended life
- Thick base material with large area for increased strength and stability during lifting

GBJ Series

Capacity:

2-100 tons

Stroke:

2.44-18.11 inches



Screw Feature

Heat treated, adjustable extension screw with cleated saddle on selected GBJ models helps adjusting and prevents slipping.

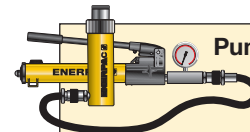

Pump and Cylinder Sets

As an alternative to Industrial Bottle Jacks where the operator is required to stand remote from the jacking point, see the range of pump and cylinder sets.

Page: 52

▼ Enerpac heavy-duty hydraulic bottle jack makes lifting loads easier.



Jack Cap.	Stroke	Model Number	Screw Extension	Min. Height	Max. Height	Plunger Dia.	Saddle Dia.	Base Dims. L x W	Wt
(ton)	(in)		(in)	(in)	(in)	(in)	(in)	(in)	(lbs)
2	18.11	GBJ002L	-	22.44	40.55	1.14	-	5.00 x 5.00	13.2
2	3.94	GBJ002	1.97	6.30	12.20	0.83	0.83	3.74 x 4.37	7.9
3	4.13	GBJ003	2.56	6.61	13.31	0.94	0.94	3.74 x 4.57	8.6
5	5.91	GBJ005	2.95	8.35	17.20	1.14	1.14	3.74 x 4.84	11.0
8	5.91	GBJ008	2.95	8.62	17.48	1.30	1.46	3.74 x 5.43	13.0
10	5.91	GBJ010	2.95	8.62	17.48	1.46	1.46	3.74 x 5.59	14.3
10	2.44	GBJ010S	1.18	5.16	8.78	1.46	1.46	3.74 x 5.59	12.1
15	5.91	GBJ015	2.95	8.98	17.83	1.75	1.73	4.41 x 6.42	19.8
20	5.91	GBJ020	2.95	9.21	18.07	2.01	2.28	5.00 x 6.73	26.7
20	4.13	GBJ020S	2.17	7.48	13.78	2.01	2.28	5.00 x 6.73	22.0
30	5.91	GBJ030	2.95	9.53	18.39	2.26	2.56	5.59 x 7.72	34.2
50	5.91	GBJ050	-	9.92	15.83	3.15	3.15	7.09 x 9.06	62.8
100	5.91	GBJ100	-	11.81	17.72	4.33	3.70	11.65 x 13.11	191.8

All GBJ Jacks meet or exceed: ANSI, PALD, CE

▼ Shown: PRASA10027L and Accessory Locking U-Rings



Safe, Efficient, Mobile Load Lifting

- 60, 100, 150 and 200-ton capacities with pneumatic or electric pumps for the toughest jobs
- 4-inch ground clearance for transport over rail and rough terrain
- Three-position handle provides easy tilt back and transport
- Complies with ASME/ANSI B30.1:2015 & CE specifications
- Easy-to-change external filter minimizes down time
- Rugged, fully enclosed 24-inch wide frame with no exposed fittings or hoses
- SUP-R-STACK™ Extension System allows lifting at all heights without blocking.



Pendant Cord

Standard 12' pendant cord for air driven units with pneumatic valves and 20' pendant cord for electric driven units keeps operator away from the load.

▼ Enerpac POW'R-RISER® used in mining operations to lift heavy equipment.



Capacity	Stroke	Electric Pump Model Number	Weight
(ton)	(in)	(115 VAC)	(lbs)
60	14	PREMB06014L	390
	27	PREMB06027L	600
100	16	PREMB10016L	510
	27	PREMB10027L	600
	16	-	-
150	27	-	-
	15.5	-	-
	26.5	-	-
	15.5	PREMB15016L	570
200	26.5	PREMB15027L	708
	15.3	-	-
	24.3	-	-

(PR-Series not available in Canada. Contact Enerpac.)

POW'R-RISER® Lifting Jack



SUP-R-STACK™ Extensions

Increase useful height from 5" to 18".

Model No.	Size (in)	Model No.	Size (in)
PRE5	5	PRE11	11
PRE7	7	PRE14	14
PRE9	9	PRE18	18
PRES6024	Extension set includes PRE5, PRE7, PRE11, PRE18		



Spacers

Fine tune your Extension stack height.

Model No.	Size (in)	Model No.	Size (in)
PRS1	1	PRS3	3
PRS2	2	-	-
PRS4	Set includes (2) PRS1, (1) PRS2 and (1) PRS3		

PR Series



Rated Lifting Capacity:
60-200 tons

Stroke:
14-27 inches

Maximum Operating Pressure:
10,000 psi



WARNING!

Extensions: Any two Extensions may be stacked for loads up to 60 tons. For loads over 60 tons or strokes over 14" only one Extension and one Spacer can be used.

Spacers: Never exceed 3" in total Spacer height.

Cap. (ton)	Swivel Load Cap	Locking U-Rings					Set Model Number	Locking U-Ring Sets Include						
		1 in.	3 in.	4 1/4 in.	5 1/2 in.	10 in.		(quantity and model numbers)						
							2X	1X	2X	1X				
60	PRTS60	PRU11	PRU13	PRU14	-	PRU110	1) PRUS126	PRU11	PRU13	PRU14	-			
							2) PRUS137	PRU11	PRU13	PRU14	PRU10			
100	PRTS60	PRU11	PRU13	PRU14	-	PRU110	1) PRUS126	PRU11	PRU13	PRU14	-			
							2) PRUS137	PRU11	PRU13	PRU14	PRU110			
150	PRTS150	PRU151	PRU153	-	PRU155	PRU1510	3) PRUS1526	PRU151	PRU153	PRU155	-			
							2) PRUS1537	PRU151	PRU1510	PRU155	-			
200	PRTS200	PRU201	PRU203	-	PRU205	PRU2010	3) PRUS2026	PRU201	PRU203	PRU205	-			
							2) PRUS2037	PRU201	PRU2010	PRU205	-			

- ¹⁾ For 14 and 16" stroke models
- ²⁾ For 27" stroke models
- ³⁾ For 15.5" stroke models

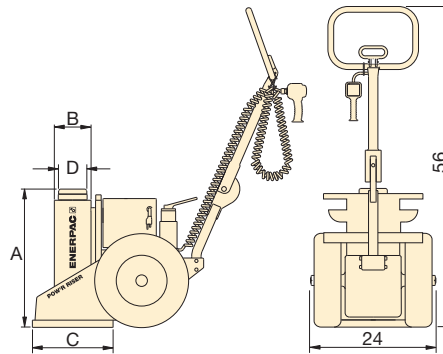

Locking U-Rings

For safe mechanical cribbing of a lifted load, accessory Locking U-Rings can be placed around an extended piston and come in four lengths for each POW'R-Riser® capacity, and are available individually or in sets. Locking U-Rings are accommodated by storage racks integral to the POW'R-Riser®.

Air Pump	Weight (lbs)	A (in)	B (in)	C (in)	D (in)	Max. Additional Stack Height Using Optional Ext. System (in)	Valve Type
PRAMA06014L	390	24	6.4	14	4	32*	Manual
PRAMA06027L	600	37	6.4	14	4	11	
PRAMA10016L	510	26	7.0	18	4	21**	
PRAMA10027L	600	37	7.0	18	4	11	Pneumatic
PRASA10016L	510	26	7.0	18	4	21**	
PRASA10027L	600	37	7.0	18	4	11	
PRASA15016L	570	26	8.0	18	5	21**	Pneumatic
PRASA15027L	708	37	8.0	18	5	11	
-	-	26	8.0	18	5	21**	
-	-	37	8.0	18	5	11	
PRASA20016L	640	26	9.5	20	6	21**	Pneumatic
PRASA20027L	825	37	9.5	20	6	11	

For power source, the following characters should be inserted in the 5th space of the model number.

Ordering Example:

Model No. PREMI06014L is a 14" stroke, 60 ton model, with a manual valve and a 208-240 VAC, 1-ph electric motor.

- A Air Pump, 50 scfm, 80 psi
- B 115 VAC, 1-ph., 50-60 Hz, 20 A
- E 208-240 VAC, 1-ph., 50-60 Hz, Euro Plug, 10 A
- I 208-240 VAC, 1-ph., 50-60 Hz, USA Plug, 10 A
- G ¹⁾208-240 VAC, 3-ph., 50-60 Hz
- W ¹⁾380-415 VAC, 3-ph., 50-60 Hz
- J ¹⁾440-480 VAC, 3-ph., 50-60 Hz
- R ¹⁾575 VAC, 3-ph., 50-60 Hz

¹⁾ Not available for 60-ton capacity

* Based on one 18" and one 11" Extension and one 3" Spacer.
** Based on one 18" Extension and one 3" Spacer.

▼ Shown: PL20025-ASA and PL20014-ASA



Efficient Lifting with Continuous, Automatic Load Locking



Pow'R-LOCK™ Self-Locking Lift System

Only the Pow'R-LOCK™ Lift System provides continuous positive locking of the load through all stages of lifting and lowering. No operator intervention is required to activate or deactivate the automatic locking system.

Two different stroke lengths are available. Both models are powered by an external compressed air system (user-supplied). A convenient two-button pendant controls operation of the Lift System's air motor and directional control valve.

- Provides continuous locking protection during lift, lower and hold functions
- Patent-pending control technology synchronizes cylinder and lock nut for smooth and efficient lifting and lowering
- Unique double-acting cylinder offers a low collapsed height to accommodate more lifting applications
- Simple 2-button pendant allows operation of raise and lower functions from up to 20 feet away
- All exposed load-bearing steel cylinder components utilize a nitrocarburizing treatment to reduce wear and resist corrosion
- Ergonomic handle has six positions for comfortable handling and folds when not in use
- Meets ANSI /ASME B30.1-2015, AS/NZS-2538, AS/NZS-2693 certification criteria



Tilt Load Cap

All Pow'R-LOCK™ Lift System models feature a Tilt Load Cap to reduce side-loading.



Enerpac declares that this product has been tested and conforms to applicable standards and is approved to carry the CE mark. An EU Declaration of Conformity is enclosed separately.



◀ The PL-Series Pow'R-LOCK Portable Lift System.

PL-Series, Pow'R-LOCK™ Portable Lift System



Accessories

Flat Load Cap – Non-tilt load cap has lower profile for tight lifting spaces.

Spacers – Minimize gap between load cap and lifting point to maximize hydraulic stroke of the jack.

Extensions – Stackable, with large alloy steel locating studs to resist effects of side-loading.

Extension Base Adapter – Extension Base Adapter design eliminates risk of improper stacking when using more than one extension.



PL Series

Rated Lifting Capacity:

200 tons

Stroke:

14 or 24.5 inches

Maximum Operating Pressure:

10,000 psi

▼ ACCESSORIES

	Model Number	Description	Height (in)	PL20014-ASA	PL20025-ASA
	PLC1	Flat Load Cap	1.3	x	x
	PLS1	Spacer	1.0	x	x
	PLS2	Spacer	2.0	x	x
	PLE5	Extension	5.0	x	x
	PLE7	Extension	7.0	x	x
	PLE9	Extension	9.0	x	x
	PLE11	Extension	11.0	x	-
	PLE14	Extension	14.0	x	-
	PLB12	Extension base adapter	12.0	x	-



WARNING!

PLE11 and **PLE14** Extensions and **PLB12** Extension Base Adapter are to be used with the "short" model **PL20014-ASA** only.

Use of these extensions on the "tall" model **PL20025-ASA** will result in an excessive maximum lifting height. Load could become unstable and drop, resulting in possible personal injury and/or property damage.

Model No.	Max. Additional Stack Height* (in)
PL20014-ASA	28.0
PL20025-ASA	9.0

* Using optional PLB and PLE-Series extensions and PLS-Series spacers. Load cap height is NOT included in the stack height.

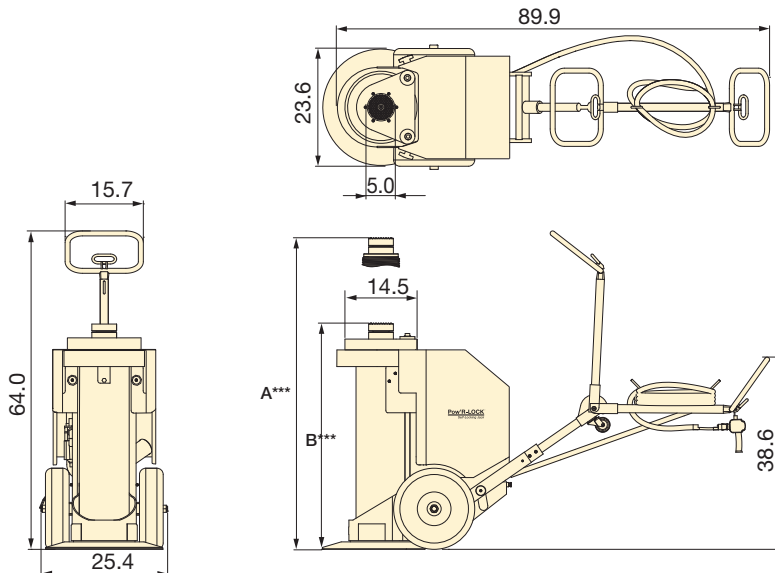

Safety First

When lifting large, heavy vehicles certain precautions must be followed. Follow your published safety directions for lifting and cribbing your loads.

The **Pow'R-LOCK™** Lift System provides load/lock protection, but you must follow the safety directions for load cribbing operations.



Pow'R-RISER® Lifting Jack

When automatic load-locking is not required, the Enerpac **Pow'R-RISER®** jack provides a mobile lifting solution.

For more information go to:
www.enerpac.com

Page: 58

Capacity (ton)	Stroke (in)	Model Number	Cylinder Lifting Speed * in/min		Recommended Air Supply**		A *** (in)	B *** (in)	Wt. (lbs)
			Load	No Load	(CFM)	(psi)			
200	14.0	PL20014-ASA	2.0	2.4	130-150	55-100	48.0	34.0	1105
	24.5	PL20025-ASA	2.0	2.4			70.0	45.5	1320

* Depending on available airflow, regulator setting, pump speed and load weight.

** Minimum dynamic air pressure of 55-60 psi, 90-100 psi required to achieve 200-ton capacity.

*** Height of items A and B is with swivel load cap installed. Subtract 2-inches if flat load cap is used.

▼ Shown: **BLS-1006**



- Climbing Jacks include integral tilt saddles with maximum tilt angles up to 5°
- Large base with anti-rotation rod for stability and safety
- Built-in safety valve prevents accidental over-pressurization
- Baked enamel finish for increased corrosion resistance
- CR-400 couplers included on all cylinder models

A Simple Solution to Incremental Lifting



Lifting Height

Climbing Jacks overcome the usual limitation of lift height imposed by the jack's plunger stroke length. Large objects, such as oil tanks, can be lifted, held and lowered for maintenance without sending for a crane.



Split-Flow Pumps

SFP-Series Pumps with multiple outlets with equal oil flow. For lifting applications on multiple points Split-Flow

Pumps are a far better alternative than using independently operated pumps.

Page: 118



EVO-Series, Synchronous Lifting Systems

The EVO-system is the ideal system for stage lifting. The system has 9 work modes

including the stage lift work mode to easily step through each stage of the lifting cycle.

Page: 120

▼ Synchronous Stage Lifting: 48 double-acting jacks (25 and 50 ton) are networked into a 16 point synchronous system to lift this 164-foot, 1100-ton building up to a height of 8-feet to construct a new floor level.



Cylinder Capacity (tons)	Stroke (in)	Model Number	Max. Cylinder Capacity (tons)	
			Push	Pull
55	5.91	BLS-506	55	12
105	6.34	BLS-1006	105	48
154	5.94	BLS-1506	154	74
220	5.94	BLS-2006	220	113

Double-Acting Climbing Jacks



◀ Typical stage-lift application using a custom built Enerpac system to lift the 360 ton Akkerwinde wooden bridge in the Netherlands.

BLS Series



Capacity per Lifting Point:

55 - 220 tons

Stroke per Stage:

5.91 - 6.34 inches

Maximum Operating Pressure:

10,000 psi

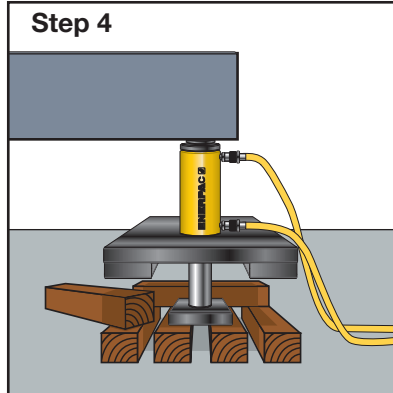
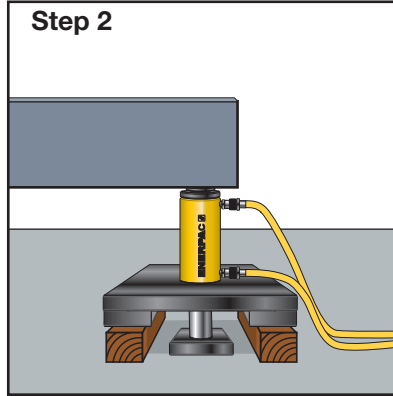
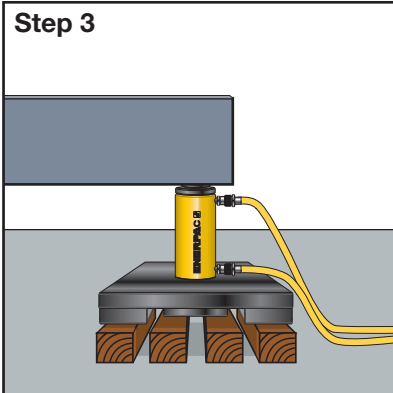
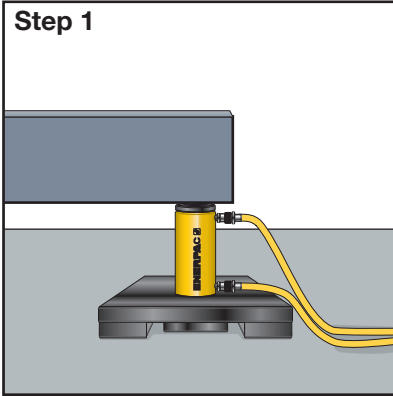

▲ Stage Lifting Sequence

Step 1: The Climbing Jack is placed on a solid support under the load (retracted plunger).

Step 2: Plunger extends, lifting the load and giving clearance to insert two outer blocks under the spreading plate.

Step 3: Plunger retracts, giving clearance to position the central blocks which will support the plunger plate for the next extension.

Step 4: Plunger extends, lifting the load, giving clearance to insert two new blocks, placed crosswise under the spreading plate.

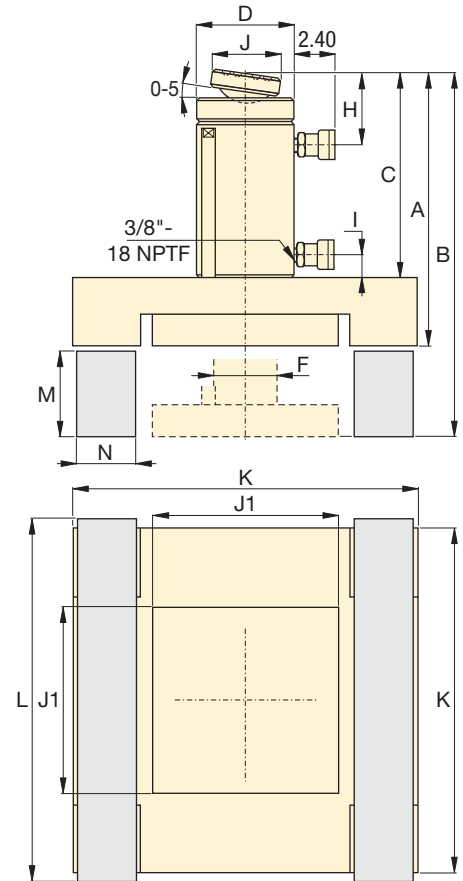

Cylinder Effective Area (in ²)		Oil Capacity (in ³)		Climbing Jack Dimensions (in)											Support Blocks * and Dimensions (in)			Wt. (lbs)	Model Number
Push	Pull	Push	Pull	A	B	C	D	F	H	I	J	J1	K	Material	L	M	N		
11.04	3.33	67.80	20.44	15.98	21.89	12.52	5.00	3.11	2.24	1.42	1.97	9.45	20.28	Azobe Wood	22.24	5.51	4.72	375	BLS-506
20.66	9.64	136.57	63.77	17.52	23.86	13.50	6.97	3.74	2.99	0.94	2.80	12.99	26.38		28.35	5.91	6.30	695	BLS-1006
30.71	14.79	188.56	90.80	18.58	24.57	14.57	8.00	4.49	3.70	1.54	5.12	9.06	18.70	Solid aluminum or steel	19.69	5.51	4.53	710	BLS-1506
44.21	22.50	264.35	134.80	20.08	26.02	15.24	9.76	5.24	4.02	1.46	5.12	10.63	21.65		22.64	5.51	5.31	825	BLS-2006

* Support blocks are not supplied by Enerpac.

▼ SHS-Series 4-Point SyncHoist System



Accurate Hoisting and Load Positioning Enhancing a Crane's Capability



Synchronous Hoisting

Enerpac SyncHoist is a unique crane product for below-the-hook positioning of heavy loads that require precision placement. The SyncHoist system may reduce the number of cranes needed and reduce the costs of multiple picks.

Functions

- High precision horizontal and vertical load positioning
- Pre-programmed positioning, tilting and aligning

Applications

- Positioning of rotor, stator and propeller blades of wind turbines
- Positioning of roof sections, concrete elements, steel structures
- Positioning of turbines, transformers, fuel rods
- Precise machinery loading, mill rod changes, bearing changes
- Precise positioning of pipe lines, blow out valves
- Positioning and aligning of ship segments prior to assembly

- High-precision load maneuvering using one crane
- Reduces the risk of damage from oscillations of wire rope due to crane jogging and sudden starts/stops
- Vastly improving worker safety, operating speed and control
- PLC-controlled hydraulics turn lifting into high-accuracy hoisting and load positioning system
- Double-acting push/pull cylinders with load-holding valves for added safety
- Increased efficiency compared to conventional load positioning methods

Options for system management and control:

- Manual control: system warning functions
- Automatic control: fully PLC-monitored system with programmable functions using touch screen and system warning functions
- Wireless control: self-contained hydraulics with hand-held control

▼ Bridge segments are hoisted from the ground, being positioned with a 4-point SyncHoist system with fully monitored cylinders.



▼ SyncHoist Powerpack to operate the 4 lifting points.



▼ A SyncHoist system used to align steel blocks of the ship's control tower sections allowing gradual lifting and positioning of the load.



SyncHoist - High Precision Load Positioning



What is SyncHoist?

Enerpac SyncHoist is a hydraulically operated auxiliary attachment for high precision load positioning for cranes. The SyncHoist system can be used for pre-programmed positioning, tilting and aligning of loads.

- Complete system tested in compliance with European lifting directive and safety requirements
- BTH-1 - 2014 compliant design of below-the-hook lifting devices

SyncHoist improves safety, operating speed and control of load movement

Geometric positioning of heavy loads in a horizontal and vertical plane are frequently done using more than one crane. Synchronizing movements between cranes are difficult and risky. The lifting inaccuracy can result in damage to the load and support structures and puts workers at risks. The SyncHoist system can be used for controlled hydraulic horizontal and vertical material handling.

System management and control

Contact Enerpac for the following options, or other customized stroke, capacity and control configurations.

1. Manual control

- Valves with manual levers
- Warnings for thermal motor protection
- Visual check: oil level, filter indicator

2. Automatic control

- Load and stroke monitoring, and stroke control
- PLC-control and touch screen
- Solenoid valves with pendant
- Pre-programmable motions and data recording
- System warnings for:
 - maximum cylinder load control setting
 - stroke and position control
 - thermal motor protection
 - oil level and filter indicator

Autonomous (wireless) system

- Wireless remote control
- Only one electric power connection per lifting point
- Integrated hydraulics, PLC and controls
- No need for hydraulic hoses and cables
- No need for mid-hoist disconnection of hoses and movement of pump

SHS/ SHAS Series



Capacity:

60 - 250 ton

Maximum Stroke:

19.69 - 59.06 inches

Accuracy Over Full Stroke:

± .040 inches

Maximum Operating Pressure:

10,000 psi

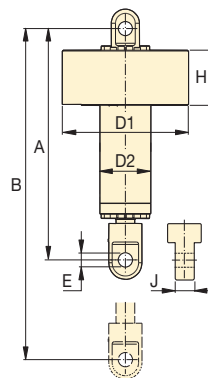

Capacity (ton)	Total Load (ton)	Cylinder Stroke (in)	Model Number ¹⁾ 460-480 VAC, 3 ph - 60 Hz	Control System	Motor Size (hp)	Number of Pump Outlets and Oil Flow ²⁾ (in ³ /min)	Cylinder Dimensions (in)							Wt. (lbs) ³⁾
							A	B	D1	D2	E	H	J	
4 x 60	240	19.69	SHS 45520 MJ	Manual	10	4 x 85	51.18	70.87	27.17	9.65	2.32	15.16	3.15	992
		39.37	SHS 45540 MJ				70.87	110.24						1378
		59.06	SHS 45560 MJ				90.55	149.61						1764
		19.69	SHS 45520 AJ	Automatic	20	4 x 128	51.18	70.78	27.17	9.65	2.32	15.16	3.15	992
		39.37	SHS 45540 AJ				70.87	110.25						1378
		59.06	SHS 45560 AJ				90.55	149.61						1764
4 x 94	376	19.69	SHS 48520 MJ	Manual	15	4 x 128	52.36	72.05	27.17	10.43	2.83	15.16	3.94	1102
		39.37	SHS 48540 MJ				72.05	111.42						1543
		59.06	SHS 48560 MJ				91.73	150.79						1984
		19.69	SHS 48520 AJ	Automatic	20	4 x 128	52.36	72.05	27.17	10.43	2.83	15.16	3.94	1102
		39.37	SHS 48540 AJ				72.05	111.42						1543
		59.06	SHS 48560 AJ				91.73	150.79						1984
4 x 120	480	39.37	SHS 411040 MJ	Manual	15	4 x 128	23.03	112.40	30.71	12.40	3.35	15.55	4.88	2138
		59.06	SHS 411060 MJ				92.72	151.77						2723
		39.37	SHS 411040 AJ	Automatic	20	4 x 128	73.03	112.40	30.71	12.40	3.35	15.55	4.88	2138
		59.06	SHS 411060 AJ				92.72	151.77						2723
4 x 120	485	39.37	SHAS 411040 WU ⁴⁾	Wireless	4 x 5	—	73.03	112.40	41.85	12.40	3.36	21.26	4.88	2608
		59.06	SHAS 411060 WU ⁴⁾				92.72	151.77						3192
4 x 250	991	39.37	SHAS 422540 WU ⁴⁾	Wireless	4 x 10	—	84.25	123.62	48.62	16.54	5.59	22.83	7.48	7097
		59.06	SHAS 422560 WU ⁴⁾				103.94	143.31						7527

¹⁾ With 4 cylinders and one 460-480 VAC-3 phase-60 Hz power pack (suffix J). For 400 VAC-3 phase-50 Hz power pack change suffix J into W. Example: SHS 45560 MW.

²⁾ Pump and cylinders include 4x 82 feet hydraulic hoses with couplers. ³⁾ Weight per cylinder.

⁴⁾ WU = with US electrical wiring. Change into suffix "WE" for EU-market. Example: SHAS 411060 WE.

Custom Hydraulic Cylinders

There's no substitute for experience in customizing hydraulic cylinders and Enerpac meets the needs of the most demanding applications.

Cylinders are the primary workhorse in hydraulic systems required to push or pull. Although Enerpac offers a wide variety of cylinders to fit many application requirements there are many

applications which require customization. These may include special corrosion protection, ability to handle extreme side loads, or having special mounting needs.



◀ *Large capacity cylinders for extreme applications.*



◀ *Cylinders with special attachments.*



◀ *Custom private labeled cylinders for OEM applications.*

OVERVIEW



▲ *Custom 500-ton cylinders with 72-inches of stroke for lifting electric rope shovels.*

CUSTOMIZABLE FEATURES:

- Stroke
- Capacity
- Paint
- Pressure Rating
- Fitting
- Special Attachments
- Seals
- Imbedded Sensors
- Collapsed Height
- Rod Modifications
- Special Mounting
- Corrosion Resistance

INFRASTRUCTURE



◀ Custom cylinders used for incremental bridge launching systems.

BUILDING CONSTRUCTION



◀ Custom cylinders for jack and slide operations.

INFRASTRUCTURE



◀ Custom SyncHoist cylinders for placement of stadium roof trusses.

POWERGEN



◀ Custom double-acting lock-nut cylinders with internal stroke sensors and an integrated load holding valve for lifting nuclear components.

INFRASTRUCTURE



◀ Custom cylinders with embedded sensors for bridge construction.

POWERGEN



◀ One of three custom SyncHoist cylinders used to place a 1,140-ton nuclear plant module.

Enerpac hydraulic pumps are available in over 1,000 different configurations. Whatever your high pressure pump needs are... speed, control, intermittent or heavy-duty performance... you can be sure that Enerpac has the pump to suit the application.

Featuring Hand, Battery, Electric, Air and Gasoline powered models, with multiple reservoir and valve configurations, Enerpac offers the most comprehensive high pressure pump line available.



Pump Selection

For help in selecting the correct pump for your application, please review our **"Yellow Pages"**. If you require further assistance, contact the Enerpac office located near you.

Page: 276























Torque Wrench Pumps

System matched air and electric pumps provide control to operate Enerpac Torque Wrenches.

Page: 232



Pumps and Directional Control Valves Section Overview

Power Source	Pump Types	Maximum Reservoir Capacity	Max. Flow at Rated Pressure (in ³ /min)	Series	Image	Page
Manual	Lightweight Hand Pumps Exclusively from Enerpac	155 in ³	.15 (in ³ /stroke)	P		70 ▶
	ULTIMA Steel Hand Pumps	453 in ³	.29 (in ³ /stroke)	P		72 ▶
	Low-Pressure Hand Pumps	200 in ³	.58 (in ³ /stroke)	P		74 ▶
	Foot Pump For Hands-Free Operation	38 in ³	.15 (in ³ /stroke)	P		76 ▶
	Multifluid Hand Pumps Pumping Fluids up to 14,500 psi	–	1.28 (in ³ /stroke)	MP		77 ▶
	Ultra-High Pressure Hand Pumps Pressure up to 40,000 psi	60 in ³	.15 (in ³ /stroke)	P/11		78 ▶
Battery	Battery Powered Hydraulic Pump Cordless Hydraulic Power	120 in ³	15	XC		80 ▶
Electric	Economy Series Compact and Portable	1 gal.	20	PU		82 ▶
	Submerged Series Powerful and Low-Noise	1.5 gal.	20	PE		86 ▶
	Z-Class Portable and Powerful	10 gal.	60 200	ZU ZE		90 ▶ 96 ▶
	8000-Series The Maximum Flow Pump	25 gal.	462	PE		102 ▶
Air	Air Hydraulic Pumps Single and Twin-Air Motor	80 in ³ 2 gal.	8 9	PA PAM		104 ▶ 105 ▶
	Turbo II Air Hydraulic Pumps Compact Air Over Hydraulic	305 in ³	10	PA		106 ▶
	XA-Series Air Hydraulic Pumps Control and Ergonomics	122 in ³	15	XA		108 ▶
	ZA4 Air Hydraulic Pumps The Standard for Air-Hydraulic Pumps	10 gal.	80	ZA		110 ▶
Gasoline	ZG5/ZG6 Gasoline Hydraulic Pumps Gas Powered High-Flow Pumps	10 gal.	200	ZG5/ ZG6		112 ▶ 114 ▶
	8000-Series Gasoline Pumps For the Largest Jobs	25 gal.	1.5 (gal/min)	EGM		115 ▶
Controlled	Level Lift System Multi-point Lifting & Lowering	5 gal.	–	LL		116 ▶
	Split Flow Pump Multi-point Lifting & Lowering	40 gal.	1.5 (gal/min)	SFP		118 ▶
	Synchronized Lifting System Computer Controlled Monitoring for Precise Lifting	66 gal.	1.25 (gal/min)	EVO		120 ▶
	Directional Control Valves					123 ▶

▼ Pumps shown, from top to bottom: P-802, P-842, P-202, P-142



Exclusively from Enerpac



Cylinder Matching Chart

For help in selecting the correct hand pump for your application, please refer to the Cylinder Matching Chart located in the “Yellow Pages”.

Page: 276



Speed Chart

To determine how a specific pump will operate your cylinder, see the Pump/Cylinder Speed Chart in the “Yellow Pages”.

Page: 283



Tank Kits

When a return-to-tank port is required, the Tank Kits provide a 7/16-20 port at the rear of the reservoir.

PC-20 Fits P-141, P-142

PC-25 Fits P-202, P-391, P-392



LX-101 Hand Pump Oil

A medium viscosity oil specially formulated for hand pumps. Performs well in low temperatures and requires less pumping effort than standard Enerpac HF blue oil.

Page: 136

- Lightweight and compact design
- Durable glass-filled nylon reservoir and nylon encapsulated aluminum pump base for maximum corrosion resistance
- Two-speed operation on most models reduces handle strokes by as much as 78% over single speed pumps
- Lower handle effort to minimize operator fatigue
- Integral 4-way valve on P-842 for operation of double-acting cylinders
- Handle lock and lightweight construction for easy carrying
- Large oil capacities to power a wide range of cylinders or tools
- Non-conductive fiberglass handle for operator safety
- Internal pressure relief valve for overload protection

▼ P-392 in action with RC-256 cylinders.



Pump Type	Usable Oil Capacity (in ³)	Model Number	Pressure Rating*		Oil Displacement per Stroke		Max. Handle Effort (lbs)
			(psi)		(in ³)		
			1 st stage	2 nd stage	1 st stage	2 nd stage	
Single speed	20	P-141	N/A	10,000	N/A	.055	72
	55	P-391	N/A	10,000	N/A	.151	85
Two speed	20	P-142**	200	10,000	.221	.055	78
	55	P-202	200	10,000	.221	.055	63
	55	P-392**	200	10,000	.687	.151	93
	155	P-802	400	10,000	2.40	.151	95
	155	P-842***	400	10,000	2.40	.151	95

* Contact Enerpac for applications where operating pressure is less than 10% of pressure rating.

** Available as set, see note on top of next page.

*** For use with double-acting cylinders.

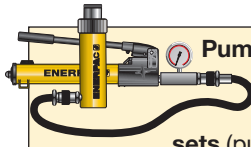

Pump and Cylinder Sets
Pumps marked with an ** are available as sets (pump, cylinder, gauge, couplers and hose) for your ordering convenience.

Page: 52

P Series



Reservoir Capacity:
20-155 in³

Flow at Rated Pressure:
.055-.15 in³/stroke

Maximum Operating Pressure:
10,000 psi

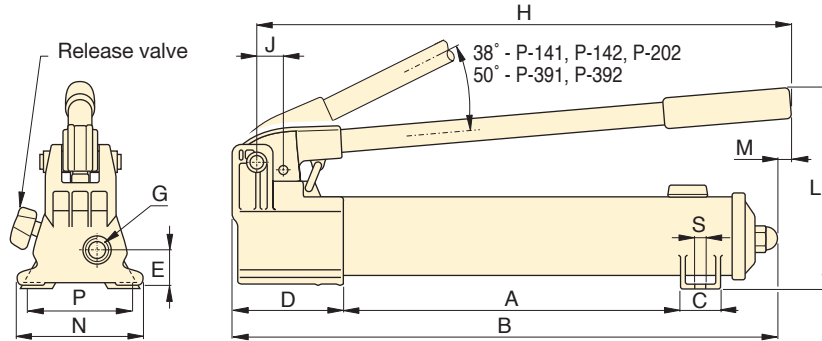

P-141, P-142, P-202, P-391, P-392

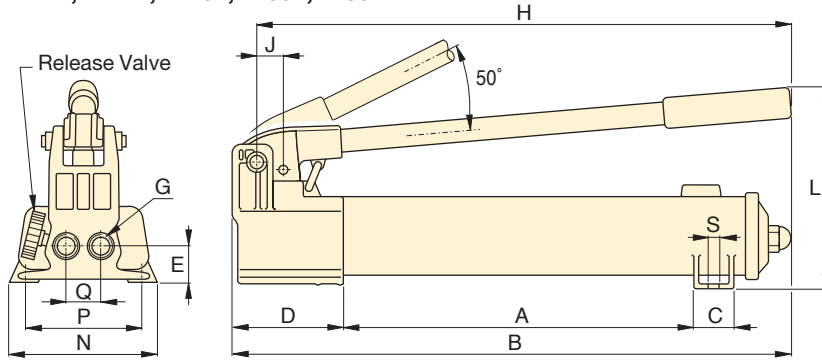

P-802

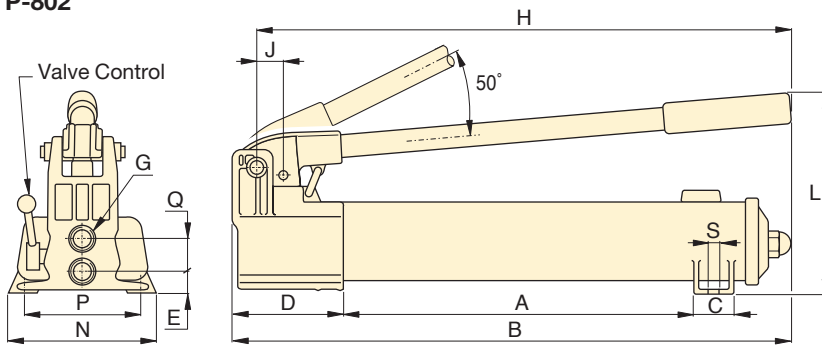

P-842



Hoses
Enerpac offers a complete line of high-quality hydraulic hoses. To ensure the integrity of your system, specify only genuine Enerpac hydraulic hoses.

Page: 132



GA45GC Gauge Adaptor
Protect yourself from system overloading by simply ordering one part number for a pre-assembled gauge, adaptor block and coupler.

Page: 144



Aluminum Reservoir
For applications where composite reservoirs may not be suitable, the **P-392AL** utilizes an extruded aluminum reservoir. Also included is a second handle for two-hand use. Contact Enerpac for details.

Piston Stroke	Dimensions (in)															Weight (lbs)	Model Number
	(in)	A	B	C	D	E	G	H	J	L	M	N	P	Q	S		
.50	7.31	13.25	1.13	3.37	1.13	1/4"-18 NPTF	12.56	.75	5.63	-	3.75	3.25	-	.28	4.5	P-141	
1.00	13.56	21.00	1.44	3.93	1.31	3/8"-18 NPTF	20.56	1.19	7.00	.63	4.75	-	-	-	9.0	P-391	
.50	7.31	13.25	1.13	3.37	1.13	1/4"-18 NPTF	12.56	.75	5.63	-	3.75	3.25	-	.28	5.3	P-142**	
.50	13.56	20.06	1.44	3.37	1.13	1/4"-18 NPTF	15.75	.75	5.69	.63	3.75	-	-	-	7.5	P-202	
1.00	13.56	21.00	1.44	3.93	1.31	3/8"-18 NPTF	20.56	1.19	7.00	.63	-	-	-	-	9.0	P-392**	
1.00	13.30	21.75	1.78	5.25	1.39	3/8"-18 NPTF	20.75	2.19	9.00	-	7.12	6.02	1.40	.41	18.0	P-802	
1.00	13.30	21.75	1.78	5.25	.81	3/8"-18 NPTF	20.75	2.19	9.00	-	7.12	6.02	1.44	.41	22.0	P-842***	

▼ Shown from left to right: P-77, P-80, P-84, P-801, P-39



The Solution for Tough Jobs



Two Speed Pumps

Recommended for applications where cylinder plunger must advance rapidly to contact load, and applications where greater oil capacities are required, such as multiple cylinder hook-ups.



Foot Pump Conversion Kits

Convert your **P39, P77, P80, or P801** to foot power with the **PC-11** Kit. Includes instructions for easy conversion.



GA45GC Gauge Adaptor

Protect yourself from system overloading by simply ordering one part number for a pre-assembled gauge, adaptor block and coupler.

Page: 144



4-Way Control Valve

P-84 and P-464 feature a manual 4-way control valve, designed for use with one double-acting or two single-acting cylinders. For system set-up information:

Page: 278

- Reduced handle effort and ergonomic grip for less operator fatigue
- Two-speed operation for fast and easy operation (except P-39)
- Vent free reservoir eliminates spills
- Quick grip handle allows for easy transport
- Integral reservoir over-pressurization protection
- All steel construction, chrome plated plunger and wiper system for durable, long lasting performance
- 4-way valving on the P84 and P-464 for operation of double-acting cylinders

▼ In the absence of a power supply, the P-80 Hand Pump offers a powerful solution.



Pump Type	Usable Oil Capacity (in ³)	Model Number	Pressure Rating*		Oil Displacement per Stroke (in ³)		Max. Handle Effort (lbs)
			1 st stage	2 nd stage	1 st stage	2 nd stage	
Single	47	P-39	N/C	10,000	N/C	.15	85
Two-speed	47	P-77	500	10,000	1.00	.15	88
	134	P-80**	500	10,000	1.00	.15	77
	250	P-801	500	10,000	1.00	.15	77
	134	P-84***	500	10,000	1.00	.15	77
	453	P-462	200	10,000	7.69	.29	110
	453	P-464***	200	10,000	7.69	.29	110

* Contact Enerpac for applications where operating pressure is less than 10% of pressure rating.

** Available as a set, see note on next page.

*** For use with double-acting cylinders.

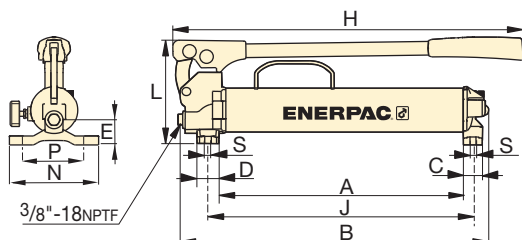

P-39, P-77

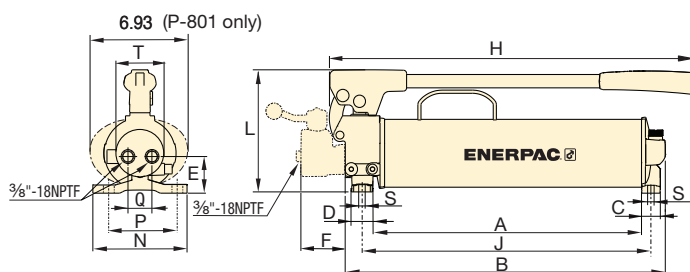

P-80, P-801, P-84

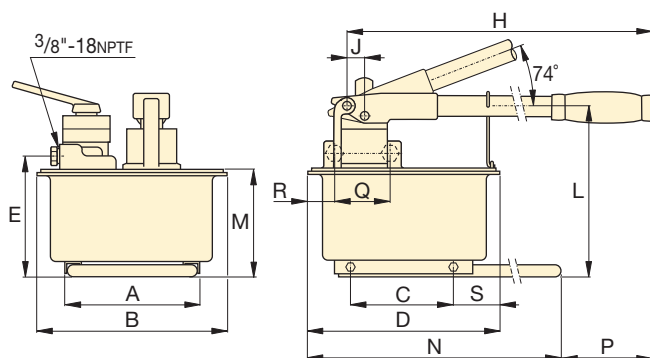

P-462, P-464

P Series



Reservoir Capacity:
47- 453 in³

Flow at Rated Pressure:
.15 - .29 in³/stroke

Maximum Operating Pressure:
10,000 psi



Extra Capacity Hand Pumps

P-462 and P-464 feature extra-large reservoirs and a high first-stage flow rate.

These pumps are ideally suited for powering high-capacity cylinders.

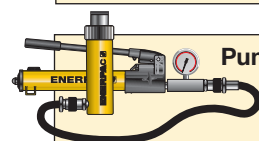

Pump and Cylinder Sets

P-80 is also available as a set (pump, cylinder, gauge, couplers and hose) for your ordering convenience.

Page: 52



Cylinder Matching Chart

For help in selecting the correct hand pump for your application, please refer to the Cylinder Matching Chart located in the "Yellow Pages."

Page: 276

Piston Stroke	Dimensions (in)																Weight (lbs)	Model Number
	(in)	A	B	C	D	E	F	H	J	L	M	N	P	Q	R	S		
1.00	15.09	18.91	1.18	1.38	1.48	-	21.63	16.37	6.39	-	5.51	4.37	-	-	0.33	-	13.6	P-39
1.00	15.39	19.19	1.18	1.38	1.86	-	21.63	16.67	6.39	-	5.51	4.37	-	-	0.33	-	15.6	P-77
1.00	16.83	20.12	1.18	1.38	2.17	-	23.50	18.11	7.65	-	5.91	4.76	1.65	-	0.33	2.93	23.6	P-80**
1.00	16.83	20.12	1.18	1.38	2.17	-	23.50	18.11	7.65	-	5.91	4.76	1.65	-	0.33	2.93	31.0	P-801
1.00	16.83	20.06	1.18	1.38	2.30	2.77	22.78	18.11	7.65	-	5.91	4.76	1.50	-	0.33	2.93	26.0	P-84***
1.50	8.25	12.13	6.42	12.63	7.68	-	26.44	.98	10.63	6.89	25.6	3.63	-	-	3.13	-	61.0	P-462
1.50	8.35	12.13	6.42	12.63	7.68	-	26.44	.98	10.63	6.89	25.6	3.63	3.50	2.68	3.13	-	61.0	P-464***

▼ Shown from left to right: P-25, P-51, P-18



When Less Than 10,000 psi is All You Need

- P-25 and P-50 pump oil in both forward and reverse handle movement improving overall efficiency, ideal when mounting space is restricted
- External load-release valve
- Internal pressure-relief valve for overload protection
- P-51 can be operated in horizontal and vertical position with pump head and oil outlet facing downwards



LX-101 Hand Pump Oil

A medium viscosity oil specially formulated for hand pumps. Performs well in low temperatures and requires less pumping effort than standard Enerpac HF blue oil.

Page: 136



GA45GC Gauge Adaptor

Protect yourself from system overloading by simply ordering one part number for a pre-assembled gauge, adaptor block and coupler.

Page: 144

▼ P-18 hand pump used for locking the rotating table for marble polishing.



Pump Type	Usable Oil Capacity (in ³)	Model Number	Pressure Rating (psi)	Oil Displacement per Stroke (in ³)	Max. Handle Effort (lbs)
Single-speed	18	P-18	2,850	0.16	34
	200	P-25	2,500	0.58	60
	200	P-50	5,000	0.29	60
	50	P-51	3,000	0.25	61

Low Pressure Hand Pumps

P Series



Reservoir Capacity:

18-200 in³

Flow at Rated Pressure:

.16-.58 in³/stroke

Maximum Operating Pressure:

2,500-5,000 psi

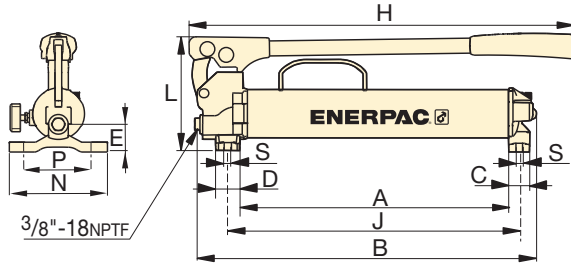

P-18

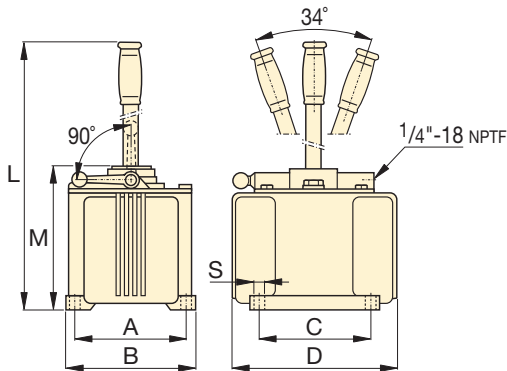

P-25, P-50

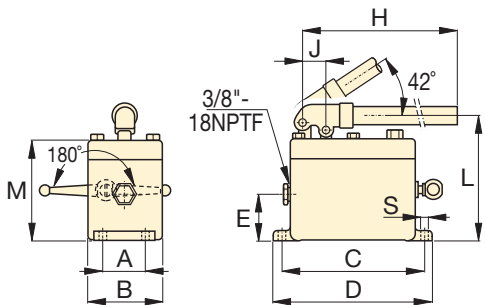

P-51



Hoses

Enerpac offers a complete line of high-quality hydraulic hoses. To ensure the integrity of your system, specify only genuine Enerpac hydraulic hoses.

Page: **132**

P-51 hand pumps used with RC-series cylinders to keep wooden layers under pressure during lamination of plates.



Piston Stroke	Dimensions (in)												Weight (lbs)	Model Number
	(in)	A	B	C	D	E	H	J	L	M	N	P		
1.00	8.70	12.44	1.18	1.38	1.48	15.17	9.98	6.39	–	5.51	4.37	.33	11	P-18
1.50	6.00	6.82	6.00	9.43	–	–	–	26.94	7.88	–	–	.40	36	P-25
1.50	6.00	6.82	6.00	9.43	–	–	–	26.94	7.88	–	–	.40	37	P-50
1.00	2.06	3.63	7.12	7.88	2.25	24.00	1.16	6.31	5.06	–	–	.34	12	P-51

Lightweight Hydraulic Foot Pump

▼ Shown: P-392FP



P Series

Reservoir Capacity:

38 in³

Flow at Rated Pressure:

.151 in³/stroke

Maximum Operating Pressure:

10,000 psi

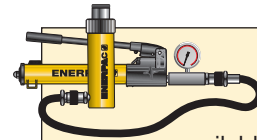

Pump and Cylinder Sets

The P-392FP is available as sets (pump, cylinder, gauge, couplers and hose) for your ordering convenience.

Page: 52

- Robust, durable and compact
 - Steel frame for maximum stability
 - Steel pumping handle
 - Aluminum reservoir
- Foot pedal lock and lightweight construction for portability
- Two-speed operation reduces foot pedal strokes
- Large foot-pad release valve for controlling load descent
- Internal pressure relief valve for overload protection



Hoses

Enerpac offers a complete line of high-quality hydraulic hoses. To ensure the integrity of your system, specify only genuine Enerpac hydraulic hoses.

Page: 132

▼ P-392FP offers the advantage of hands-free operation to handle and control the tool or cylinder.

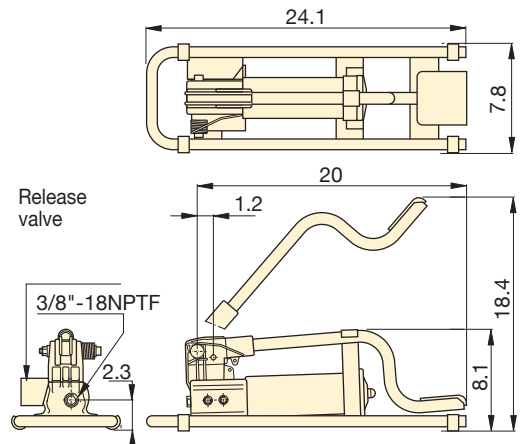

Usable Oil Capacity (in ³)	Model Number	Pressure Rating (psi)		Oil Displacement per Stroke (in ³)		Max. Handle Effort (lbs)	Piston Stroke (in)	Weight (lbs)
		1st stage	2nd stage	1st stage	2nd stage			
30	P-392FP *	200	10,000	.687	.151	125	1	16

* Available as set, see note on this page.

Multifluid Hand Pumps

▼ Shown: **MP-110**



MP Series

Reservoir Capacity:

2 gal. (optional)

Flow at Rated Pressure:

.12-1.28 in³/stroke

Maximum Operating Pressure:

1,500-14,500 psi



Optional Reservoir Kit

The two-gallon reservoir kit **MP-10T*** includes tank with skid frame, top plate with reservoir seal, suction pipe and mounting bolts. Useable oil capacity is 1.5 gal.

*For use with mineral oil applications only.



Also available is model number **11-400**.

Page: **78**

- Superior corrosion resistance
- Impregnated aluminum anodized pump housing with stainless steel internal pumping components
- Standard Nitrile seals – excellent for demineralized water, oil/water emulsions, water glycols, mineral oils, hydraulic fluids
- Custom EPDM seals available for use with Skydrol® or brake fluids
- Two-speed pumps up to 14,500 psi pressure
- Externally adjustable pressure-relief valve
- 1/4" NPTF gauge port

▼ MP-Series pumps are ideal for testing and filling applications.

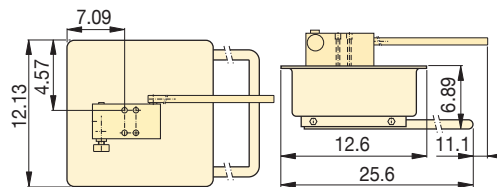

MP-10T

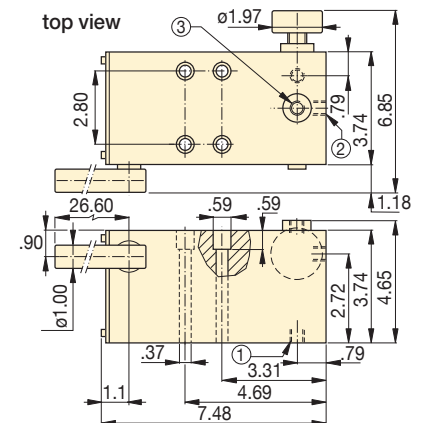

MP-110, 350, 700, 1000

① Suction / Tank return port 3/8"-18 NPTF

② Pressure port 3/8"-18 NPTF

③ Gauge port 1/4"-18 NPTF

Pump Type	Usable Oil Capacity (in ³)	Model Number	Pressure Rating (psi)		Oil Displacement per Stroke (in ³)		Max. Handle Effort (lbs)	Piston Stroke (in)	Weight (lbs)
			1st stage	2nd stage	1st stage	2nd stage			
Two Speed	*	MP-110	500	1500	3.2	1.28	99	1.04	14.5
	*	MP-350	500	5000	3.2	.43	99	1.04	14.5
	*	MP-700	500	10,000	3.2	.18	99	1.04	14.5
	*	MP-1000	500	14,500	3.2	.12	99	1.04	14.5

Note: MP-Pump includes .060 in. thick gasket for reservoir mounting.

* MP-Series pumps require the use of an external reservoir.

▼ Shown from left to right: 11-100, P-2282



Ultra-High Pressure up to 40,000 psi



2-Way Shut-Off Valve 72-750

For 40,000 psi applications requiring a shut-off valve or gauge snubber. Made of 318 Stainless Steel and utilizing .38-inch cone fittings, it is the perfect selection for use with your Ultra-High Pressure Hand Pump.



Test System Gauges

Ideal for monitoring pressure in your hydraulic circuit, Test System Gauges, such as the T-6010L, are available with cone threads or NPTF threads and in a variety of pressure ranges.

Page: 142

- Two-speed operation on the P-2282 allows for faster fill, reducing cycle times for many testing applications
- 303 Stainless steel construction on the 11-100 and 11-400 models enable use with many different fluids, such as distilled water, alcohol, diesters, silicones, soluble oils and petroleum
- Large release knob for improved control of pressure release
- Outlet ports are 3/4"-16 cone for 40,000 psi rating

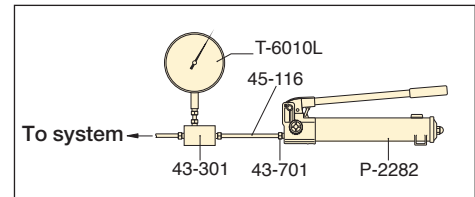

▲ Typical Test System

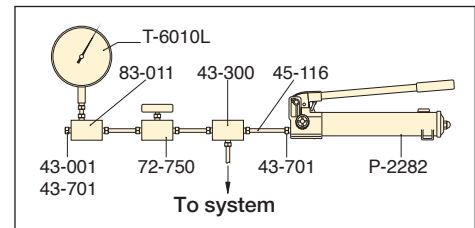

▲ Test System with Gauge and Snubber

Cone Seal

Stainless Steel High Pressure fittings seal on a "cone" surface and do not require pipe sealer. The Gland Nut holds the sleeve and tubing tight against the cone surface to provide a 40,000 psi seal.

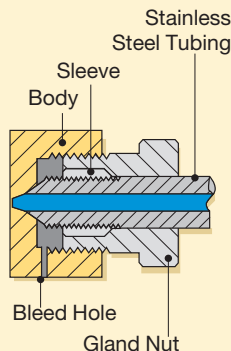

Pump Type	Usable Oil Capacity (in ³)	Model Number	Pressure Rating* (psi)		Oil Displacement per Stroke (in ³)		Max. Handle Effort (lbs)
			1st stage	2nd stage	1st stage	2nd stage	
Two-speed	60	P-2282	200	40,000	.99	.037	106
Single-speed	45	11-100	N/C	10,000	N/C	.152	120
	45	11-400	N/C	40,000	N/C	.038	120

* Contact Enerpac for applications where operating pressure is less than 10% of pressure rating.

Ultra-High Pressure Hand Pumps

▼ Optional Ultra-High Pressure Fittings and Tubing

Description	Connection	Model No.
40,000 psi		
Gland Nut Plug	.38" cone	43-001
Elbow	.38" cone	43-200
Tee	.38" cone	43-300
Gauge Tee	.38" cone side/ .25" cone gauge port	43-301
Gauge Adaptor	.38" cone side/ .25" cone gauge port	83-011
Coupling	.38" cone	43-400
Cross	.38" cone	43-600
Gland Nut with Sleeve	.38" cone	43-701
Gauge Connector	.25" cone	43-704
Tubing	4" tube, O.D. .38" * 8" tube, O.D. .38" * 12" tube, O.D. .38" *	45-116 45-126 45-136
 WARNING: Maximum working pressure: 10,000 psi only		
Adaptor	.38" F cone to 1/4" M NPTF .38" F cone to 3/8" M NPTF	41-146 41-166
Adaptor	.38" F cone to 1/4" F NPTF .38" F cone to 3/8" F NPTF	41-246 41-266
Adaptor	.38" M cone to 3/8" F NPTF	41-366

Note: .25" cone fittings use 9/16"-18 threads, 3/8" cone fittings use 3/4"-16 threads.

* Actual tubing lengths are .75" less than nominal size shown. These dimensions make distance between centers of valves and fittings multiples of 4" spaces.

P/11 Series



Reservoir Capacity:

45-60 in³

Flow at Rated Pressure:

.037-.152 in³/stroke

Maximum Operating Pressure:

10,000-40,000 psi



Stainless Steel Construction

Ultra-high Pressure Fittings feature all stainless-steel construction except adaptor 41-366, which features nickel plated carbon steel construction.



Ultra-High Pressure pumps DO NOT have an internal safety pressure relief valve.

11-100*, 11-400

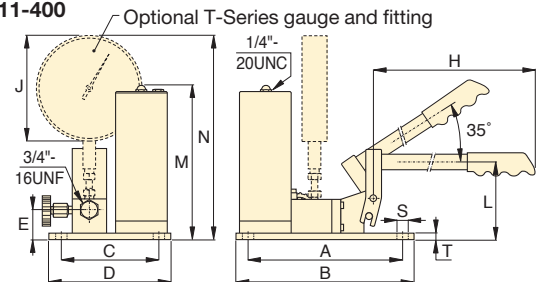

*NOTE: Maximum operating pressure for model 11-100 is 10,000 psi.

P-2282

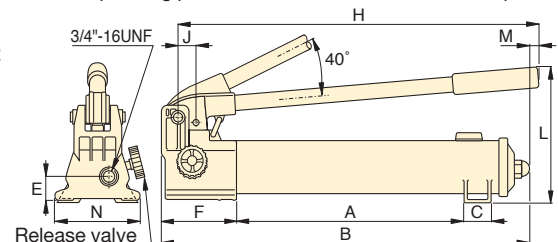

Piston Stroke	Dimensions (in)														Weight (lbs)	Model Number
	(in)	A	B	C	D	E	F	H	J	L	M	N	S	T		
1.00	13.56	22.00	1.40	–	1.24	5.25	20.75	1.16	9.00	.28	4.74	–	–	14	P-2282	
.78	9.45	10.50	5.98	7.00	1.77	–	25.00	6.41	4.50	9.33	12.38	.31	.37	22	11-100	
.78	9.45	10.50	5.98	7.00	1.77	–	25.00	6.41	4.50	9.33	12.38	.31	.37	22	11-400	

▼ Shown: XC-1201



Performance of a Powered Pump

Portability of a Hand Pump

- Lightweight design with integrated handle and carrying strap for portability
- Bladder reservoir prevents contamination and allows pump usage in any position
- Powerful ½ horsepower motor and 28-volt Lithium-Ion battery deliver exceptional speed and run time
- High-strength fiberglass reinforced composite shroud for superior durability in demanding job site environments
- Cordless technology eliminates tripping hazards found in other electric or air powered pumps
- Available in both single-acting and double-acting valve configurations



GA45GC Gauge Adaptor

Protect yourself from system overloading by simply ordering one part number for a pre-assembled gauge, adaptor block and coupler.

Page: 144



Battery packs contain no cadmium, so they are environmentally friendly. Enerpac encourages recycling.



28-Volt Battery

The XC-28V with Lithium-Ion technology for maximum battery performance.



Battery Charger

1-hour quick charger.

XC-115VC	115 VAC
XC-230VC	230 VAC



Hydraulic Swivel Connector

Customer installed swivel connector for optimal orientation of the hydraulic hose.

Order model number ¹⁾

XSC1

¹⁾ Accessories must be ordered separately.

◀ Power and simplicity for the toughest jobs.

Cordless Hydraulic Pump



XC-Series Cordless Hydraulic Pump

The XC-Series cordless pump is ideal for jobs that require a combination of portability, speed, and safety. These cordless pumps are perfect for remote locations without access to power, but also indoors where trip hazards, ergonomics or size is a concern. The XC-Series cordless pump is compatible with all Enerpac hydraulic tools and small to medium sized cylinders.

The Lithium-Ion battery provides superior run time, even under extreme job site conditions.*

- 279 cuts of 3/8 inch reinforcing bar using the WHC-750 Cutter
- 112 lifts with the WR-5 Spreader
- 44 splits on 1-inch, grade 8 nuts using the NC-3241 Nut Splitter
- 28 lifts of an RC-104

The XC-Series cordless pump is CSA and CE compliant.

*Actual number of cycles per charge will vary depending on condition of tool, battery and ambient conditions. Battery life with double-acting tools is approximately 75% of that for comparable, single-acting tools.



XC Series



Reservoir Capacity:
60-120 in³

Flow at Rated Pressure:
15 in³/min.

Maximum Operating Pressure:
10,000 psi

- ① Outlet "Advance" Port
- ② Oil Fill (must use funnel)
- ③ User-Adjustable Relief Valve Access Port
- ④ Directional Control Valve
- ⑤ Shoulder Strap Connection Points
- ⑥ Safety Lock Feature
- ⑦ On/Off Switch
- ⑧ Inlet "Retract" Port (double-acting models only)

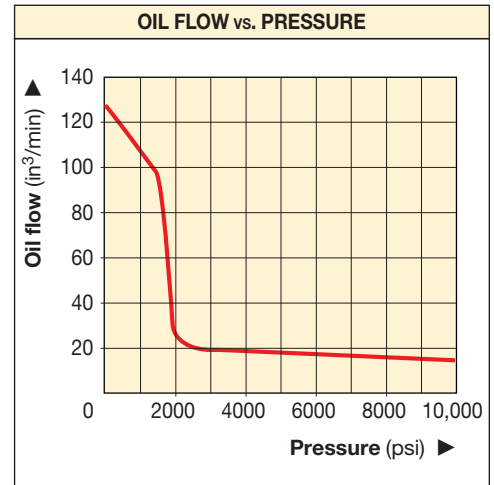
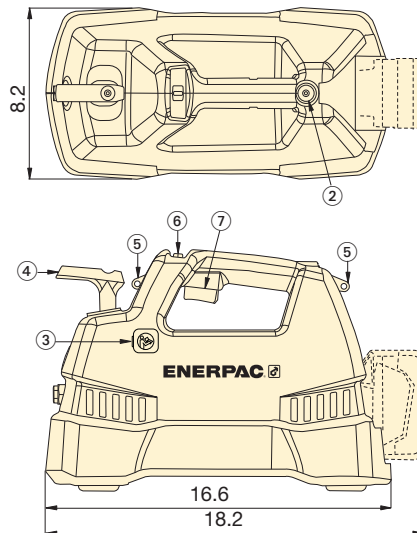
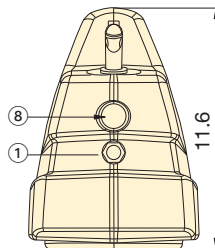

Oil Capacity (in ³)	Model Number	Output Flow Rate (in ³ /min)			Valve Function	Charger Voltage (VAC)	Weight (lbs)
		No Load	2000 psi	10,000 psi			
60	XC-1201MB	125	30	15	3-way, 2-pos.	115	21.9
120	XC-1202MB	125	30	15			23.8
60	XC-1201ME	125	30	15	3-way, 2-pos.	230	21.9
120	XC-1202ME	125	30	15			23.8
60	XC-1201M*	125	30	15	3-way, 2-pos.	-	21.9
120	XC-1202M*	125	30	15			23.8
60	XC-1401MB	125	30	15	4-way, 3-pos.	115	22.3
120	XC-1402MB	125	30	15			24.2
60	XC-1401ME	125	30	15	4-way, 3-pos.	230	22.3
120	XC-1402ME	125	30	15			24.2
60	XC-1401M*	125	30	15	4-way, 3-pos.	-	22.3
120	XC-1402M*	125	30	15			24.2

* Batteries and charger not included.

▼ Take the battery pump anywhere without power cords or air hoses.



▼ Shown: PUJ-1200B



Heavy on Performance, Light on Weight



Hoses

Enerpac offers a complete line of high-quality hydraulic hoses. To ensure the integrity of your system, specify only Enerpac hydraulic hoses.

Page: 132



Gauges

Minimize the risk of overloading and ensure long, dependable service from your equipment. For use with the Economy pump, the **G-2535L** gauge and **GA-3** gauge adaptor are suggested.

For a full range of gauges, please refer to the System Components section.

Page: 131



Speed Chart

To determine how the 0.5 hp Economy pump will operate your cylinder, see the Pump/Cylinder Speed Chart in the "Yellow Pages".

Page: 283

- Lightweight and compact design
- Large easy-carry handle for maximum portability
- Two-speed operation reduces cycle times for improved productivity
- 115 VAC 50/60-cycle universal motor will operate on voltages as low as 60 volts
- 24 VAC remote motor control, 10-ft length for operator safety
- Starts under full load
- High strength molded shroud with integral handle, protects motor from contamination and damage
- Designed for intermittent duty cycle

▼ An Economy Pump, PUJ-1200B, is used with an RCS-302 to reposition a Scissor lift to simplify maintenance.



Used with Cylinder	Usable Oil Capacity (gal)	Model Number*	Pressure Rating	
			(psi)	
			1 st stage	2 nd stage
Single-acting	.50	PUD-1100B	200	10,000
	1.00	PUD-1101B	200	10,000
	.50	PUD-1300B	200	10,000
	1.00	PUD-1301B	200	10,000
	.50	PUJ-1200B	200	10,000
	1.00	PUJ-1201B	200	10,000
Double-acting	.50	PUJ-1400B	200	10,000
	1.00	PUJ-1401B	200	10,000



About the Economy Pump

The Economy pump is best suited to power small to medium size cylinders or hydraulic tools. Its lightweight and compact design makes it ideal for applications which require easy transport of the pump.

The Universal motor works well on long extension cords or generator-driven electrical power supplies.

For further application assistance refer to the "Yellow Pages".

PUD-1100 Series

- Provides advance/auto-retract of single-acting cylinders
- Ideal for punching applications

- For applications not requiring load holding
- 10-ft pendant controls motor and valve operation

PUD-1300 Series

- Provides advance/hold/retract of single-acting cylinders
- 10-foot pendant controls motor and valve operation
- Ideal for applications requiring remote valve operation.

PUJ-Series

- Available with 3- and 4-way valves for single- or double-acting cylinders
- 10-ft cord controls the motor operation
- Manual valves provide advance/retract tool control



* NOTE: CE conformity marking only applies to pumps with an "E" suffix.

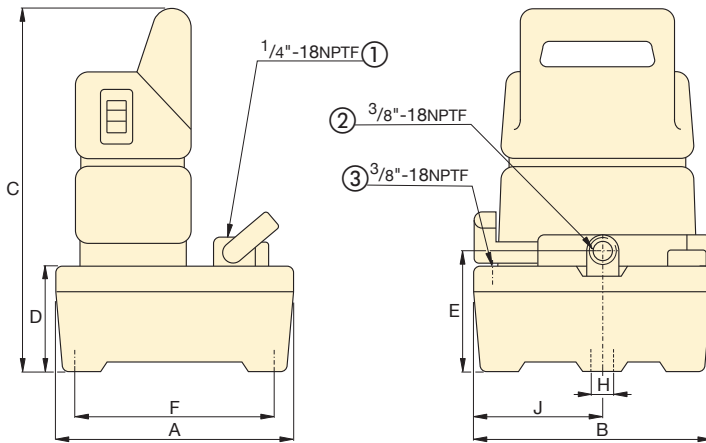

- ① Gauge Port (PUJ-1200/1201 only)
- ② Outlet Port
- ③ Tank Port

PU Series



Reservoir Capacity:
0.5-1.0 gal.

Flow at Rated Pressure:
20 in³/min.

Motor Size:
.5 hp

Maximum Operating Pressure:
10,000 psi

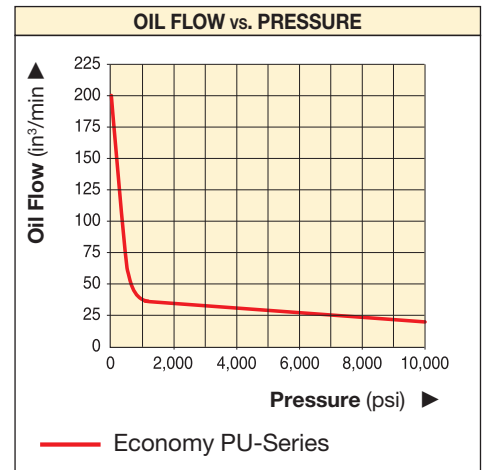

Output Flow Rate		Valve Type	Current Draw	Motor Voltage	Sound Level	Dimensions (in)								Weight	Model Number*
1 st stage	2 nd stage					A	B	C	D	E	F	H	J		
200	20	Dump **	9.5	115	85	9.62	9.62	14.25	4.00	4.72	8.00	.40	5.25	26	PUD-1100B
200	20		9.5	115	85	14.50	12.18	14.72	4.15	5.12	12.74	.40	5.62	35	PUD-1101B
200	20	Dump and Hold	9.5	115	85	9.62	9.62	14.25	4.00	4.72	8.00	.40	5.25	26	PUD-1300B
200	20		9.5	115	85	14.50	12.18	14.72	4.15	5.12	12.74	.40	5.62	35	PUD-1301B
200	20	3-way, 2-pos.	9.5	115	85	9.62	9.62	14.25	4.00	4.72	8.00	.40	5.25	24	PUJ-1200B
200	20		9.5	115	85	14.50	12.18	14.72	4.15	5.12	12.74	.40	5.62	31	PUJ-1201B
200	20	4-way, 3-pos.	9.5	115	85	9.62	9.62	14.25	4.00	4.72	8.00	.40	5.25	29	PUJ-1400B
200	20		9.5	115	85	14.50	12.18	14.72	4.15	5.12	12.74	.40	5.62	36	PUJ-1401B

* For 230 volt applications replace "B" suffix with "E". (CE conformity marking only applies to pumps with an "E" suffix.)
** Electric dump valve for auto-retract of cylinders.

▼ Shown: PEJ-1401B



Best Performance for Mid-Range Cylinders and Tools

▼ SELECTION CHART

For more technical information see next page.

5 BASIC PUMP TYPES

Select the model that suits your application. For special requirements see page 87 or contact your Enerpac office.

PED-Series: with Dump Valve

- Ideal for punching, crimping and cutting
- For use when load holding is not required
- Control pendant with 10 ft. cord controls valve and motor

PEM-Series: with Manual Valve

- Ideal choice for most applications
- Manual valve control, for both single-acting and double-acting applications
- Manual motor control

PER-Series: with Solenoid Valve

- Ideal for production and lifting
- All valves are 3-position for Advance/Hold/Retract
- Control pendant with 10 ft. cord for remote valve operation

PEJ-Series: with Remote Jog

- For light production and lifting applications
- Manual valve control for single-acting or double-acting cylinders
- Control pendant with 10 ft. cord for remote motor operation

PES-Series: with Pressure Switch

- Designed for maintaining pressure applications, such as clamping, workholding and testing
- All versions include manual valves for directional control

* Contact Enerpac for details on VM style valves.

- Two-speed operation reduces cycle times for improved productivity
- Powerful .5 hp induction motor is submerged in the oil reservoir to run cooler, protect the motor, simplify the pump interface, save space and reduce noise
- Large 1.5 gallon reservoir allows operation of a wide range of cylinders
- 24 VDC remote pendant control on certain models for safer operation
- Externally adjustable relief valve allows control of operating pressure without opening the pump
- 40-micron internal return line filter keeps oil clean, promoting longer pump life
- Full-length side tube for easy monitoring of oil level



◀ The Remote Jog model of the Submerged Pump simplifies maintenance on this machine.

Submerged Electric Pumps



Submerged Pump Application

The Submerged pump is best suited to power small to medium size cylinders or hydraulic tools, or whenever a quiet, intermittent duty cycle is needed. With its low sound level and the addition of the optional oil cooler, the Submerged pump is suited to light production work as well.

Its lightweight and compact design also make it ideal for applications which require some transport of the pump.

For further application assistance see the "Yellow Pages" or contact your local Enerpac office.



Page: 273

* NOTE: CE conformity marking only applies to pumps with an "E" suffix.

PE Series



Reservoir Capacity:

1.5 gal.

Flow at Rated Pressure:

20 in³/min.

Motor Size:

.5 hp

Maximum Operating Pressure:

10,000 psi

Pump Type	Used with Cylinder	Valve Function	Valve Type*	Usable Oil Capacity (gal)	Model Number* 115 VAC, 1 ph	Weight (lbs)
	Single-acting	Advance/Retract	Dump	1.5	PE-1101B	55
	Single-acting	Advance/Retract	Manual VMP 10000D	1.5	PEM-1201B	53
	Single-acting	Advance/Hold/Retract	Manual VMF 10000D	1.5	PEM-1301B	53
	Double-acting	Advance/Hold/Retract	Manual VMC 10000D	1.5	PEM-1401B	53
	Single-acting	Advance/Hold/Retract	Solenoid (VEF-15500D)	1.5	PER-1301B	65
	Double-acting	Advance/Hold/Retract	Solenoid (VEC-15600D)	1.5	PER-1401B	65
	Single-acting	Advance/Retract	Manual VMP 10000D	1.5	PEJ-1201B	55
	Single-acting	Advance/Hold/Retract	Manual VMF 10000D	1.5	PEJ-1301B	55
	Double-acting	Advance/Hold/Retract	Manual VMC 10000D	1.5	PEJ-1401B	55
	Single-acting	Advance/Retract	Manual VMP 10000D	1.5	PES-1201B	62
	Double-acting	Advance/Hold/Retract	Manual VMC 10000D	1.5	PES-1401B	62

* For 230 volt applications replace "B" suffix with "E". (CE conformity marking only applies to pumps with an "E" suffix.)

◀ For full features see page 84.

Submerged Pump Performance							
Motor Size	Pressure Rating		Output Flow Rate**		Motor Electrical Specifications*	Sound Level	Relief Valve Adjustment Range
	(psi)		(in ³ /min)				
	1 st stage	2 nd stage	1 st stage	2 nd stage			
0.5	1,000	10,000	150	20	13 @ 115-1-50/60 6.75 @ 230-1-50/60	62-70	1,000-10,000

* At bypass and maximum pressure. See matrix footnotes on next page for Hz limitations.

** All flow data at 60 Hz, 50 Hz data will be 5/6th this number.

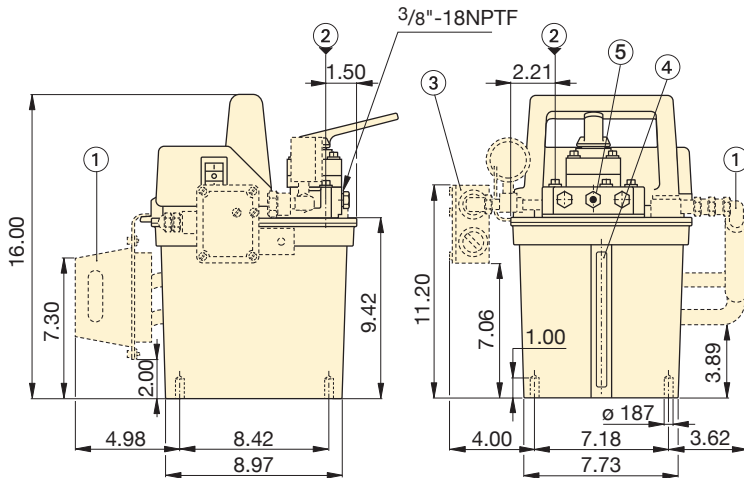

Dimensions shown in inches.

- ① Heat Exchanger (optional for all models)
- ② Fill Port
- ③ Pressure Switch (PES-Series, optional for other models)
- ④ Oil Level Indicator
- ⑤ Adjustable Relief Valve

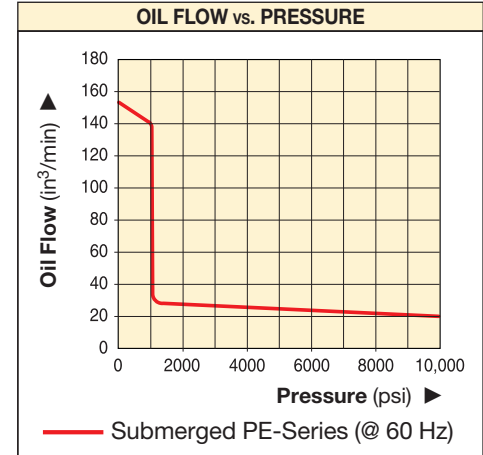

Speed Chart

To determine how a submerged pump will operate your cylinder, see the Pump/Cylinder Speed Chart in the "Yellow Pages".

Page: 283



◀ This PED-1101B Submerged pump quickly and quietly powers Enerpac's hydraulic Nut Cutter in this maintenance application.

Submerged Electric Pumps Ordering Matrix

CUSTOM BUILD YOUR SUBMERGED PUMP

If the Submerged Pump that would best fit your application cannot be found in the chart on page 84, you can easily build your custom submerged pump here.

▼ This is how a Submerged Pump Model Number is built up:



1	2	3	4	5	6	7
Product Type	Motor Type	Pump Type	Pump Series	Valve Type	Reservoir Size	Motor Voltage

1 Product Type

P = Pump

2 Motor Type

E = Electric motor

3 Pump Type

D = Dump

J = Jog

M = Manual

R = Remote (Solenoid)^{1) 2)}

S = Pressure switch

4 Pump Series

1 = .5 hp, 10,000 psi

5 Valve Type

0 = No valve (PER only)

1 = Dump

2 = 3-way, 2-position, normally open

3 = 3-way, 3-position, tandem center

4 = 4-way, 3-position, tandem center

5 = Modular valve (PER only)

6 Reservoir Size

01 = 1.5 gallon

7 Motor Voltage and Heat Exchanger

B = 115 V, 1 Ph, 60 Hz ¹⁾

D = 115 V, 1 Ph, 60 Hz ¹⁾

with heat exchanger

E = 230 V, 1 Ph, 50 Hz ²⁾

F = 230 V, 1 Ph, 50 Hz ²⁾

with heat exchanger

I = 230 V, 1 Ph, 60 Hz

¹⁾ Solenoid valves operate only at 60 Hz.
Can also run at 50 Hz with manual valve

²⁾ Solenoid valves operate only at 50 Hz.
Can also run at 60 Hz with manual valve

Ordering Example

Model Number: PER-1301B

The PER-1301B is a .5 hp, 10,000 psi, submerged electric pump, with 1.5 gallon usable oil capacity, a 3-way, 3-position modular, remote solenoid valve and a 115 V, 1 Phase, 60 Hz motor.

PE Series



Reservoir Capacity:

1.5 gal.

Flow at Rated Pressure:

20 in³/min.

Motor Size:

.5 hp

Maximum Operating Pressure:

10,000 psi



Hoses

Enerpac offers a complete line of high-quality hydraulic hoses. To ensure the integrity of your system, specify only genuine Enerpac hydraulic hoses.

Page: 132



Gauges

Minimize the risk of overloading and ensure long, dependable service from your equipment. Refer to the System Components section for a full range of gauges.

Page: 131



The PER-1301B, PER-1401B, PER-1301D and PER-1401D include a Modular (solenoid) Valve and pilot operating check.

Page: 146

Introducing the *Z-Class* power pumps from Enerpac – pumps that run cooler, use less electricity and are easy to service.

Enerpac has used the latest metallurgical, bearing and seal technologies to produce a pump whose features and benefits far surpass the electric pumps that are available today. By reducing the number of moving parts, improving flow dynamics and decreasing friction, Z-Class pumps will stay on the job longer, require less energy to operate and when needed, have lower service costs.

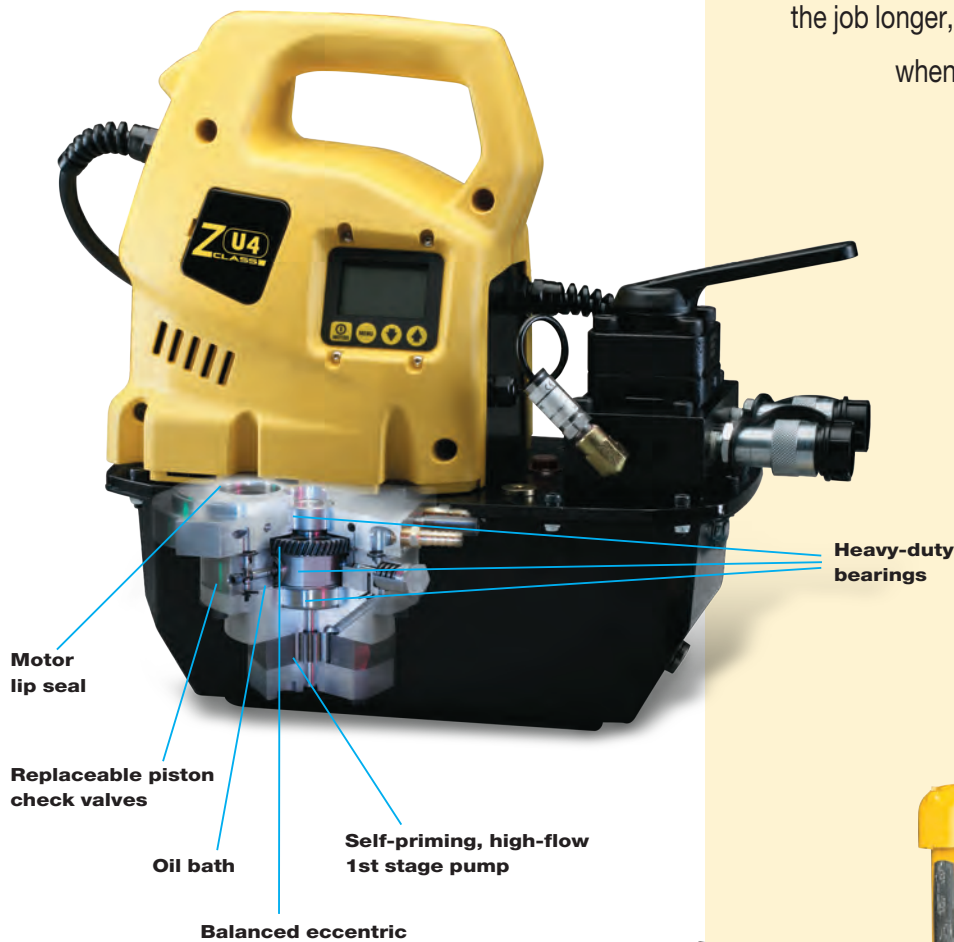

Z-Class electric pumps from Enerpac – simply the best pump you will ever use.



Z Tough.
Dependable.
Innovative.
ZCLASS

Z-Class Pumping Element — The Heart of Your Hydraulic System

Highly efficient design provides increased flow rates, reduced heat generation and a decrease in power consumption. This means improved tool speed and increased service life — which results in higher productivity and lower operating costs.

Heavy-duty bearings extend pump life by reducing friction, reducing surface-loading and lowering bearing stresses.

Pump cavity oil bath extends pump life by reducing heat, improving lubrication and reducing wear.

Self-priming, high-flow 1st stage pump increases pump performance by super-charging the 2nd stage piston pump — improving oil flow in both hot and cold weather operation.

Balanced rotating components reduce vibration creating a smoother running pump — reducing wear, friction and sound levels.

Replaceable piston check-valves increase service life of major pump components.

Ergonomic low-voltage pendant features sealed switches and operates at 24 VDC for improved operator safety.

Back-lit LCD on select Z-Class pumps

- pump usage information, hour and cycle counts
- low-voltage warning and recording
- offers self-test and diagnostic capabilities
- information displayed in six languages
- pressure read-out (when used with the optional pressure transducer)
- adjustable trigger pressure setting (when used with the optional pressure transducer)



Back-lit LCD available on ZU and ZE-Series Electric Pumps ▶

Z-Class factory installed options & accessories

Extensive list of accessories including heat exchanger, roll-bars, skid bar, pressure transducer, return line filter and level and temperature switches, allow complete pump control over a wide range of industrial applications.

Z-Class electric pumps for your application

Available in one flow range for universal motor and four flow ranges for induction motor. Choose from single or two-stage models to provide the optimum cylinder and tool performance for almost any industrial application.



ZU4 Series Pump Applications

- **Mobile:** when frequent pump transport is required and/or on remote locations
- **Universal motor:** 1-phase, runs well under poor voltage supply, using generator power supply or using long extension cord
- **Duty-cycle:** for intermittent applications
- **Cylinders and tools:** for medium to large size single and double-acting applications and high speed.



ZE Series Pump Applications

- **Stationary:** when pump remains in one location
- **Induction motor:** 1 and 3-phase for high-cycle usage
- **Duty-cycle:** for heavy-duty, extended cycle application
- **Cylinders and tools:** for medium to large size single- and double-acting applications and high speed

Oil Flow Rate @ 10,000 psi (in ³ /min)	Z-Class Pump Series*	Electric Motor Size (hp)	Air Motor Consumption (scfm)	Gasoline Engine Size** (ft.lbs)	Page:
40	ZE3	1.0	—	—	96
60	ZE4(T)	1.5	—	—	96, 240
60	ZU4(T)	1.7	—	—	90, 236
80	ZA4(T)	—	100	—	110, 242
100	ZG5	—	—	**	112
120	ZE5(T)	3.0	—	—	96, 240
200	ZE6	7.5	—	—	96
200	ZG6	—	—	17	114

* ZE4T, ZU4T, ZA4T and ZE5T-Series are Torque Wrench Pumps.

**ZG5 is available in two 4-cycle engine sizes: 7.1 Ft.lbs Honda and 8.5 Ft.lbs Briggs & Stratton.

▼ Shown from left to right: ZU4304MB, ZU4420SB-H, ZU4304PB-K



Z Tough.
Dependable.
Innovative.
ZCLASS

- Features **Z-Class** high-efficiency pump design; higher oil flow and bypass pressure, cooler running and requires 18% less current draw than comparable pumps
- Powerful 1.7 hp universal electric motor provides high power-to-weight ratio and excellent low-voltage operating characteristics
- High-strength, molded composite shroud protects motor and electronics, while providing an ergonomic, non-conductive handle for easy transport
- Low-voltage pendant provides additional safety for the operator (remote control units)

Pro-Series pump only

- LCD readout provides pressure and a number of diagnostic and readout capabilities never before offered on a portable electric pump
 - pump usage information, hour and cycle counts
 - self-test, diagnostic and read-out capabilities
 - pressure readout and auto-mode pressure settings

▼ **COMMON PUMP MODELS**

For technical information and other options see next page.

BASIC PUMP TYPES	
Select the model that suits your application. For special requirements contact your Enerpac office.	
Manual Valve	
<ul style="list-style-type: none"> • Ideal choice for most applications • Manual valve control, for single-acting or double-acting applications • Motor control on shroud 	
Manual Valve with Pendant	
<ul style="list-style-type: none"> • For light production and lifting applications • Manual valve control for single-acting or double-acting cylinders • Low-voltage control pendant with 10-ft. cord for remote motor operation 	
Dump Valve	
<ul style="list-style-type: none"> • Ideal for punching, crimping and cutting • For use when load-holding is not required • Low-voltage control pendant with 10-ft. cord controls valve and motor 	
Solenoid Valve	
<ul style="list-style-type: none"> • Ideal for lifting applications and where remote control is required • Motor runs continuously on pumps with VE33 and VE43 valves. With VE32 valve, motor only runs during the advance function, while holding and retracting, the motor is off • Low-voltage control pendant with 10 ft. cord for remote motor and valve operation 	



◀ Designed to be tough, the ZU4-Series with steel reservoirs will take the abuse of today's construction sites.

ZU-Series, Electric Pumps



Z-Class – A Pump For Every Application

Patented Z-Class pump technology provides high

by-pass pressures for increased productivity—important in applications using long hose runs and high pressure-drop circuits, like heavy lifting or certain double-acting tools.

Enerpac ZU4 Hydraulic Pumps are built to power small to large-sized cylinders or hydraulic tools, or wherever high-speed, intermittent duty, remote hydraulic power is needed.

Classic Electric Pump

- The *Classic* has traditional electro-mechanical components (transformers, relays and switches) in place of solid-state electronics. The *Classic* delivers durable, safe

and efficient hydraulic power for demanding markets like construction, post-tensioning and foundation repair.

Standard Electric Pump

- For applications that do not require digital display features of the Premium Pump. Available in all manual or jog versions.

Pro Electric Pump

- Digital (LCD) display features a built-in hour meter and shows self-diagnostic, cycle-count and low voltage warning information.

Pressure can also be displayed when the pump is equipped with an optional pressure transducer.



ZU Series



Reservoir Capacity:

1.0-10.0 gal.

Flow at Rated Pressure:

60 in³/min.

Motor Size:

1.7 hp

Maximum Operating Pressure:

10,000 psi

Pump Type	Used with Cylinder		Valve Function			Valve Type ²⁾	Pump Control	Usable Oil Capacity (gal)	Model Number 115 VAC ³⁾ 1 Phase			Pro Product Weight With Oil ⁴⁾ (lbs)
									Classic	STD Electric	Pro Electric	
	●		●		●	VM22	Manual	1.0	ZU4704RB	ZU4704MB	ZU4704LB	59
	●		●		●	VM22	Manual	2.0	ZU4708RB	ZU4708MB	ZU4708LB	69
	●		●	●	●	VM33	Manual	2.0	ZU4308RB	ZU4308MB	ZU4308LB	70
	●		●	●	●	VM33	Manual	5.0	ZU4320RB	ZU4320MB	ZU4320LB	109
		●	●	●	●	VM43	Manual	2.0	ZU4408RB	ZU4408MB	ZU4408LB	70
		●	●	●	●	VM43	Manual	5.0	ZU4420RB	ZU4420MB	ZU4420LB	109
	●		●		●	VM22	Remote (Man.)	1.0	ZU4704PB	ZU4204JB	ZU4204KB	60
	●		●		●	VM22	Remote (Man.)	2.0	ZU4708PB	ZU4208JB	ZU4208KB	70
	●		●		●	VM22	Remote (Man.)	5.0	ZU4720PB	ZU4220JB	ZU4220KB	109
	●		●	●	●	VM33	Remote (Man.)	2.0	ZU4308PB	ZU4308JB	ZU4308KB	71
		●	●	●	●	VM43	Remote (Man.)	2.0	ZU4408PB	ZU4408JB	ZU4408KB	71
		●	●	●	●	VM43	Remote (Man.)	5.0	ZU4420PB	ZU4420JB	ZU4420KB	110
	●		●		●	VE32D	Remote	1.0	N/A	N/A	ZU4104DB	63
	●		●		●	VE32D	Remote	2.0	N/A	N/A	ZU4108DB	73
	●		●		●	VE32D	Remote	5.0	N/A	N/A	ZU4120DB	112
						-	-	-	-	-	-	-
						-	-	-	-	-	-	-
						-	-	-	-	-	-	-
	●		●	●	●	VE32	Remote	1.0	N/A	N/A	ZU4204SB	63
	●		●	●	●	VE32	Remote	2.0	N/A	N/A	ZU4208SB	73
	●		●	●	●	VE33	Remote	2.0	N/A	N/A	ZU4308SB	85
		●	●	●	●	VE43	Remote	2.0	N/A	N/A	ZU4408SB	85
		●	●	●	●	VE43	Remote	5.0	N/A	N/A	ZU4420SB	124
						-	-	-	-	-	-	-
						-	-	-	-	-	-	-
						-	-	-	-	-	-	-

¹⁾ CE conformity marking only applies to pumps with an "E" suffix. "E" voltage versions also meet all requirements of the European EMC-Directive.

²⁾ See valves section for technical information on valve types.

³⁾ See custom order matrix for other voltage options.

⁴⁾ Subtract 3 lbs. for STD Electric models.

ZU Series, Specifications and Dimensions

ZU4 Performance							
Motor Size	Output Flow Rate (in ³ /min)				Motor Electrical Specification	Sound Level	Relief Valve Adjustment Range
	(hp)	100 psi	700 psi	5000 psi			
1.7	700	535	76	60	115-1-50/60 230-1-50/60	85-90	2,000-10,000

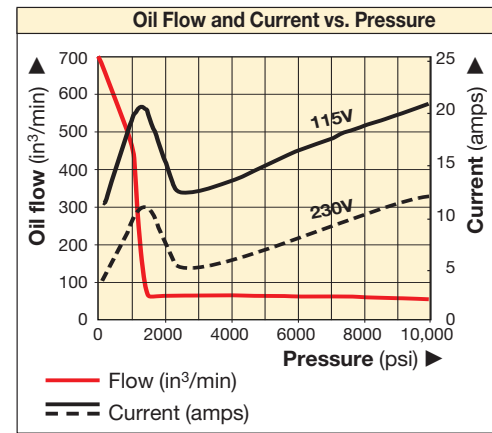

ZU-4 Series with 1 and 2 gallon reservoirs

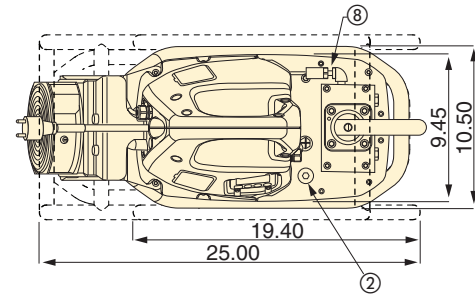
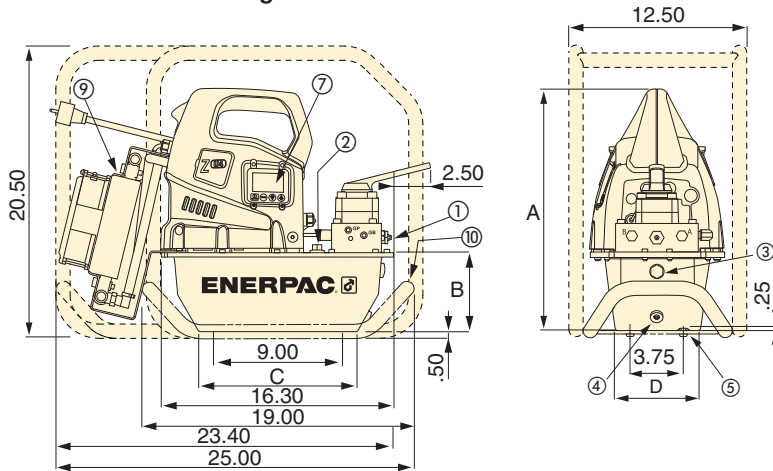

ZU-4 Series with 2.5, 5.0 and 10.0 gallon reservoirs

(Left view shown without side handle)

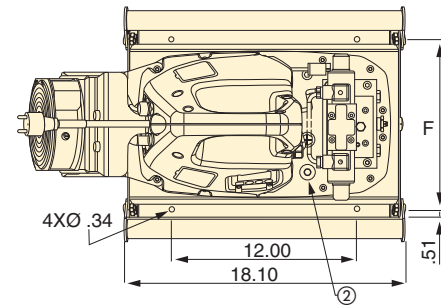
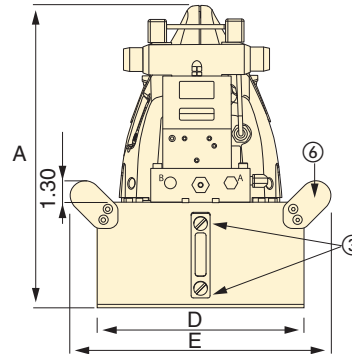
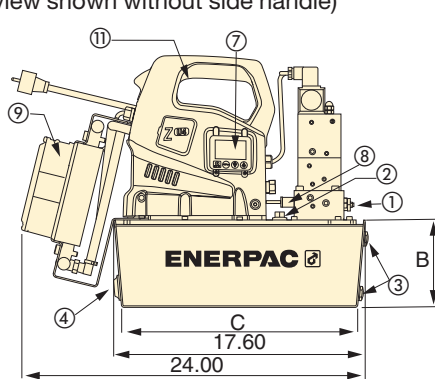

- ① User adjustable relief valve
- ② Oil fill port, SAE#10
- ③ Oil level sight gauge
- ④ Oil Drain, 1/2" NPTF
- ⑤ M8 x 1.25
- ⑥ Handles on all 2.5, 5.0, and 10.0-gallon reservoirs

Factory installed features and options

- ⑦ Back-lit LCD Electric
- ⑧ Pressure transducer
- ⑨ Heat exchanger
- ⑩ Skid bar
- ⑪ Handle guard installed on all 2.5, 5, and 10-gallon reservoirs
- ⑫ Reservoir handles included on all 2.5, 5 and 10-gallon pumps



Increased output flow and extended brush life increase productivity for post-tensioning applications.

Usable Reservoir Capacity (gal)	Pump Dimensions (in)					
	A	B	C	D	E	F
1.0	16.7	5.6	11.0	6.0	-	-
2.0	16.7	5.6	11.0	8.1	-	-
2.5	17.3	6.2	16.5	12.0	15.1	11.0
5.0	18.3	7.1	16.5	16.6	19.7	15.6
10.0	21.7	10.6	15.7	19.9	22.7	18.9

CUSTOM BUILD YOUR ZU4 SERIES PUMP

If the ZU4 Series pump that would best fit your application cannot be found in the chart on page 91, you can easily build your custom ZU4 Series pump here.

▼ This is how a ZU-Series pump model number is built up:



1	2	3	4	5	6	7	8	
Product Type	Motor Type	Flow Group	Valve Type	Reservoir Size	Valve Operation	Voltage	Options and Accessories	

1 Product Type

Z = Pump Series

2 Motor Type

U = Universal electric motor

3 Flow Group

4 = 60 in³/min @ 10,000 psi

4 Valve Type (see page 128 for more details)

- 1 Dump (VE32D)
- 2 3 way/2 position manual or electric (VM32 or VE32)
- 3 3 way/3 position manual or electric (VM33 or VE33)
- 4 4 way/3 position manual or electric (VM43 or VE43)
- 6 3 way/3 position locking manual w/po check (VM33-L)
- 7 3 way/2 position manual (VM22)
- 8 4 way/3 position locking manual w/po check (VM43-L)
- 9 4 way/3 position manual w/power seating (VM43-LPS)
- 10 3 way/3 position manual, Venturi-Valve (VM33VAC)
- 11 3 way/3 position electric, Venturi-Valve (VE33VAC)

5 Reservoir Size (useable capacity)

- 04 = 1.0 gallon
- 08 = 2.0 gallon
- 10 = 2.5 gallon (includes side handles)
- 20 = 5.0 gallon (includes side handles)
- 40 = 10.0 gallon (includes side handles)

6 Valve Operation

- D = Dump (solenoid valve w/pendant and LCD Electric)
- J = Jog (manual valve w/pendant and Standard Electric (i.e. w/o LCD))
- K = Jog (manual valve w/pendant and LCD Electric)
- L = Manual valve w/LCD Electric (w/o pendant)
- P = Manual valve w/pendant and classic electric (i.e. w/o LCD)
- R = Manual valve w/Classic electric (i.e. w/o LCD) [w/o pendant]
- M = Manual valve w/Standard Electric (i.e. w/o LCD) [w/o pendant]
- S = Solenoid valve w/pendant and LCD Electric

7 Voltage

- B = 115V, 1 ph, 50/60Hz
- E = 208-240V, 1 ph, 50/60 Hz (w/European plug and CE EMC compliant)
- I = 208-240V, 1 ph, 50/60 Hz (w/NEMA 6-15 plug)

8 Options and Accessories (see page 94 for possibilities)

- F = Filter
- G = 0-15,000 psi gauge (2½")¹⁾
- H = Heat exchanger
- K = Skidbar (1 and 2 gallon reservoirs only)
- L = Level/temp switch²⁾³⁾
- N = No reservoir handles (includes lifting eyes)
- R = Roll cage
- T = Pressure transducer²⁾
- U = Foot switch

¹⁾ Pressure gauge not available on pump models with pressure transducer

²⁾ These options require LCD electric

³⁾ Not available on 1 and 2 gallon reservoirs

ZU Series



Reservoir Capacity:

1.0-10.0 gal.

Flow at Rated Pressure:

60 in³/min.

Motor Size:

1.7 hp

Maximum Operating Pressure:

10,000 psi



Speed Chart

To determine how a "Z" pump will operate your cylinder, see the Pump/Cylinder Speed Chart in the "Yellow Pages".

Page: **283**



Ordering Example

Model Number:
ZU4408LB-HKT

ZU4408LB-HKT is a 60 in³/min at 10,000 psi pump with a 4-way, 3-position manual valve, a 2 gal. (8-liter) reservoir, operates on 115V, 1ph, 50/60 Hz and is specified with optional LCD electrical panel, heat exchanger, pressure transducer and skid bar.



Torque Wrench Pumps

System matched air and electric pumps provide control to operate Enerpac Torque Wrenches.

Page: **212**



Assisted-Return Pumps

To improve productivity and plunger retraction, Enerpac offers valve configurations designed to accelerate your cylinder retraction speeds. ZU4 and ZE-Series pumps feature Venturi valve technology to facilitate the faster return of single-acting gravity return cylinders. See details on www.enerpac.com



Pressure Transducer*

- More durable than analog gauges (against mechanical and hydraulic shock)
- More accurate than analog gauges (0.5% full scale of pump)
- Calibration can be fine-tuned for certification
- “Set pressure” feature turns off motor at user defined pressure (or shifts valve to neutral on models with VE33/VE43 valves)
- Display pressure in psi, bar, or MPa

* Requires LCD Electric

Accessory Kit Model Number	Adjustable Pressure Range (psi)	Switch-point repeatability	Dead-band (psi)
ZPT-U4 *	50-10,000	± 0,5%	50

* Add suffix **T** for factory installation.

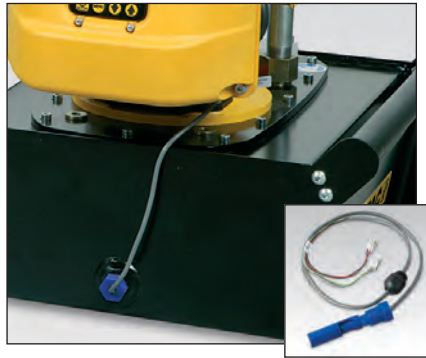

Level/Temperature Switch

- Ensures feedback on pump oil level and temperature
- Drop-in design allows for easy installation to pump reservoir
- Plugs directly into pump electrical enclosure
- Built-in thermal sensing shuts off pump when unsafe operating temperature is reached
- Oil level switch shuts down pump before oil reaches an unsafe operating level

Model Number	Operating Temperature (° F)	Maximum Pressure (psi)	Weight (lbs)
ZLS-U4	40-230	150	.11

* Add suffix **L** for factory installation.



Hoses

Enerpac offers a complete line of high-quality hydraulic hoses. To ensure the integrity of your system, specify only Enerpac hydraulic hoses.

Page: 132



Gauges

Minimize the risk of overloading and ensure long, dependable service from your equipment. Refer to the System Components section for a full range of gauges.

Page: 131



Foot Switch

- Hands-free remote control on solenoid dump and 3-position valves
- With 10-foot cord

Accessory Kit No.	Can be used on ZU4 Pumps with
ZCF-2 *	Solenoid VE-Series valves

* Add suffix **U** for factory installation.



Roll Cage

- Protects pump
- Provides greater pump stability

Accessory Kit Number	Fits on Reservoir
ZRC-04 *	1 and 2 gallon ¹⁾
ZRC-04H *	1 and 2 gallon ²⁾
ZRB-10 *	2.5 gallon
ZRB-20 *	5 gallon
ZRB-40 *	10 gallon

* Add suffix **R** for factory installation.

¹⁾ Without heat exchanger ²⁾ With heat exchanger

Ordering Example:
Model No. ZU4208BB-QR



Skidbar*

- Provides easy two-hand lift
- Provides greater pump stability on soft or uneven surfaces
- Also available as an add-on kit (model number SBZ-4)

* 1 and 2-gallon reservoirs only

Accessory Kit No.	For ZU-Series Pumps with Reservoir	Wt. (lbs)
SBZ-4 *	1-2 gal. w/o heat exchanger	4.9
SBZ-4L *	1-2 gal. with heat exchanger	5.5

* Add suffix **K** for factory installation.

ZU-Series Factory Installed Options and Accessories



ZU4-Series Options

Accessory Kits can be installed by the customer.

See chart below for all possible options on ZU4-Series pumps:

- Classic Electric,
 - Standard (STD) Electric (no LCD)
 - Pro Electric (with LCD).
- Refer to page 93 for ordering matrix.

ZU4-Series Options	Factory Installed			Accessory Kits		
	Classic Electric	Standard Electric	Pro Electric	Classic Electric	Standard Electric	Pro Electric
Return Line Filter	F	F	F	ZPF	ZPF	ZPF
Skid Bar ¹⁾	K	K	K	SBZ	SBZ	SBZ
Roll Cage	R	R	R	ZRC	ZRC	ZRC
Heat Exchanger	H	H	H	ZHE	ZHE	ZHE
Pressure Gauge	G	G	G	G	G	G
Pressure Transducer	-	-	T	-	-	ZPT-U4
Level/Temperature Switch	-	-	L	-	-	ZLS-U4
Foot Switch	-	-	U	-	-	ZCF-2

¹⁾ Skid Bar not in combination with Roll Cage.

ZU Series



Reservoir Capacity:

1.0-10.0 gal.

Flow at Rated Pressure:

60 in³/min.

Motor Size:

1.7 hp

Maximum Operating Pressure:

10,000 psi



Return Line Filter

- 25 micron nominal filter removes contaminants from return oil flow before allowing it back into tank
- Internal by-pass valve prevents damage if filter is dirty
- With maintenance indicator

Accessory Kit Model Number	Maximum Pressure (psi)	Maximum Oil Flow (GPM)	By-pass Setting (psi)
ZPF *	200	12.0	25

* Add suffix F for factory installation.



Heat Exchanger

- Removes heat from the bypass oil to provide cooler operation
- Stabilizes oil viscosity, increasing oil life, and reduces wear of pump and other hydraulic components

Accessory Kit No. *	Can be used on
ZHE-U115	115V pumps
ZHE-U230	230V pumps

* Add suffix H for factory installation.



Heat Exchanger

- Extends system life
- Stabilizes oil temperature at a maximum of 130° F at 70° F ambient temperature.

Do not exceed maximum oil flow and pressure ratings. Heat exchanger is not suitable for water-glycol or high water based fluids.

Thermal Transfer *	Maximum pressure (psi)	Maximum oil flow (GPM)	Voltage (VDC)
Btu/h	900	7.0	12

* At GPM at 70 °F ambient temperature.

▼ Shown from left to right: ZE3304MB-K, ZE4110DB-FHR



Z

Tough.
Dependable.
Innovative.

CLASS





The New Standard for Industrial Applications



Oil Level Indicators

All ZE pumps feature an oil level indicator—sight glasses on the 1 and 2-gallon reservoirs and oil level gauges on the 2.5, 5 and 10-gallon reservoirs.

▼ SELECTION CHART *

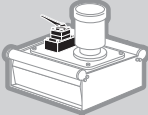
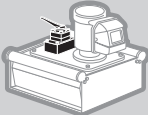
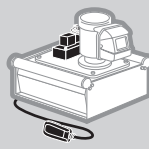
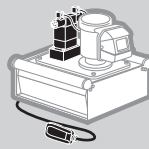
BASIC PUMP CONFIGURATIONS Select your ZE pump model here for most applications. For special requirements, see the ZE Pump ordering matrix.		Pump Type	Used with Cylinder					Valve** Model Number	Useable Oil Capacity (gal)	
										
MANUAL VALVE CONTROL	Manual Valve without electric box or LCD • Ideal choice for most applications • Manual valve control, for both single-acting or double-acting applications • Manual motor control • On/off switch on 1-phase electric motor		●	—	●	—	●	VM32	2.0	
			●	—	●	●	●	VM33	2.0	
			●	—	●	●	●	VM33	5.0	
			●	—	●	●	●	VM33	10.0	
			—	●	●	●	●	VM43	2.0	
			—	●	●	●	●	VM43	5.0	
	MANUAL VALVE CONTROL	Manual Valve with electric box and LCD • Ideal choice for most applications • Manual valve control, for both single-acting or double-acting applications • Manual motor control		●	—	●	—	●	VM32	2.0
				●	—	●	—	●	VM32	2.5
				●	—	●	●	●	VM33	5.0
				●	—	●	●	●	VM33	10.0
				—	●	●	●	●	VM43	5.0
				—	●	●	●	●	VM43	10.0
REMOTE VALVE CONTROL	Solenoid Dump Valve with electric box and LCD • Ideal for punching, crimping and cutting • For use when load holding is not required • Push-button control pendant with 10-ft. cord controls the valve and motor		●	—	●	—	●	VE32D	1.0	
			●	—	●	—	●	VE32D	2.0	
			●	—	●	—	●	VE32D	2.5	
			●	—	●	—	●	VE32D	5.0	
			●	—	●	—	●	VE32D	10.0	
	REMOTE VALVE CONTROL	Solenoid 3-position Valve with Electric Box and LCD • Ideal for production and lifting applications • All valves are 3-position for Advance-Hold-Retract • Push-button control pendant with 10-ft. cord controls the valve and motor		●	—	●	●	●	VE33	2.0
				●	—	●	●	●	VE33	2.5
				●	—	●	●	●	VE33	5.0
				—	●	●	●	●	VE43	2.0
				—	●	●	●	●	VE43	2.5
				—	●	●	●	●	VE43	5.0
				—	●	●	●	●	VE43	10.0

* Models in this chart are 115 VAC, 1-phase at 50/60 Hz for ZE3-4 or 220 VAC, 3 phase at 50/60 Hz for ZE5-6. For other options, please refer to the ZE Pump ordering matrix. ** See Valve Section for technical information.

ZE-Series Electric Pumps

- Features **Z-Class** high-efficiency pump design; higher oil flow and by-pass pressure, cooler running and requires 18% less current draw than comparable pumps
- Totally enclosed, fan-cooled industrial electric motors supply extended life and stand up to harsh industrial environments
- Low-voltage pendant, on certain models, provides additional safety for the operator
- Multiple valve and reservoir configurations provide application specific models to match the most demanding industrial applications
- High-strength, molded electrical enclosure protects electronics, power supplies and LCD readout from harsh industrial environments
- LCD readout provides a number of diagnostic and readout capabilities never before offered on an industrial pump (included with electric valve models, optional on other models)
- IP54 Rating for superior dust and water protection

ZE Series



Reservoir Capacity:
1.0-10.0 gal.

Flow at Rated Pressure:
40-200 in³/min

Motor Size:
1.0-7.5 hp

Maximum Operating Pressure:
10,000 psi



User Adjustable Relief Valve

All VM and VE-Series have a user adjustable relief valve to allow the operator to easily set the optimum working pressure.



Locking Valves

For applications requiring positive load holding, VM-Series valves (except VM32) are available with a

pilot-operated check valve. This provides hydraulic locking of the load until the valve is shifted into the retract position. To order this feature on your ZE-series pump see the valve type in the order matrix.

Page: 99



Single-Stage or Two-Stage

Choose single-stage pumps for applications that require constant flow regardless of pressure, such as testing or clamping.

Two-stage pumps have an increased output flow at low pressure to allow fast movement towards the load, for reduced cycle times and increased productivity. To specify a single-stage pump, place the letter "S" at the end of the model number.

For example: **ZE5320LG-S**

ZE3 Series (1.0 hp) Output Flow Rate at 10,000 psi: 40 in ³ /min		ZE4 Series (1.5 hp) Output Flow Rate at 10,000 psi: 60 in ³ /min		ZE5 Series (3.0 hp) Output Flow Rate at 10,000 psi: 120 in ³ /min		ZE6 Series (7.5 hp) Output Flow Rate at 10,000 psi: 200 in ³ /min	
Model Number	Wt. (lbs)	Model Number	Wt. (lbs)	Model Number	Wt. (lbs)	Model Number	Wt. (lbs)
ZE3208MB	91	ZE4208MB	100	-	-	-	-
ZE3308MB	92	ZE4308MB	101	-	-	-	-
ZE3320MB	132	ZE4320MB	141	ZE5320MG	152	ZE6320MG	191
ZE3340MB	183	ZE4340MB	192	ZE5340MG	203	ZE6340MG	242
ZE3408MB	92	ZE4408MB	101	-	-	-	-
ZE3420MB	132	ZE4420MB	141	ZE5420MG	152	ZE6420MG	191
ZE3440MB	183	ZE4440MB	192	ZE5440MG	203	ZE6440MG	242
ZE3208LB	96	ZE4208LB	105	-	-	-	-
ZE3210LB	109	ZE4210LB	112	ZE5210LG	132	ZE6210LG	171
ZE3320LB	138	ZE4320LB	146	ZE5320LG	160	ZE6320LG	199
ZE3340LB	188	ZE4340LB	197	ZE5340LG	210	ZE6340LG	249
ZE3420LB	138	ZE4420LB	145	ZE5420LG	160	ZE6420LG	199
ZE3440LB	189	ZE4440LB	197	ZE5440LG	210	ZE6440LG	250
ZE3104DB	94	ZE4104DB	103	-	-	-	-
ZE3108DB	105	ZE4108DB	109	-	-	-	-
ZE3110DB	114	ZE4110DB	122	ZE5110DG	136	ZE6110DG	175
ZE3120DB	141	ZE4120DB	149	ZE5120DG	163	ZE6120DG	202
ZE3140DB	190	-	-	-	-	-	-
ZE3308SB	112	ZE4308SB	121	-	-	-	-
ZE3310SB	125	ZE4310SB	134	ZE5310SG	147	ZE6310SG	187
ZE3320SB	152	ZE4320SB	161	ZE5320SG	174	ZE6320SG	213
ZE3408SB	112	ZE4408SB	121	-	-	-	-
ZE3410SB	125	ZE4410SB	134	ZE5410SG	147	ZE6410SG	187
ZE3420SB	152	ZE4420SB	161	ZE5420SG	174	ZE6420SG	213
ZE3440SB	203	ZE4440SB	212	ZE5440SG	225	ZE6440SG	264

* All models in this chart are 115 VAC, 1-phase at 50/60 Hz. For other options please refer to the ZE Pump ordering matrix.

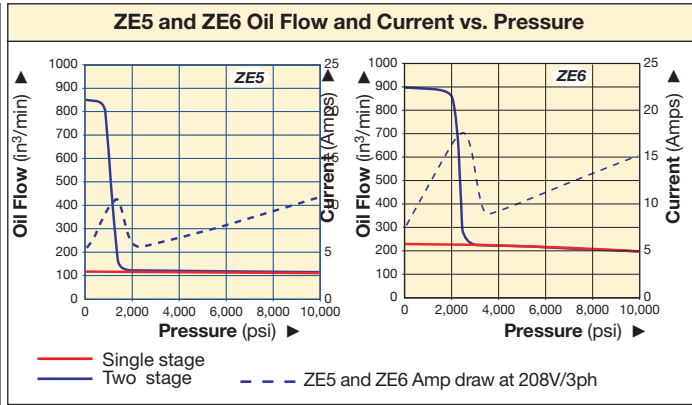
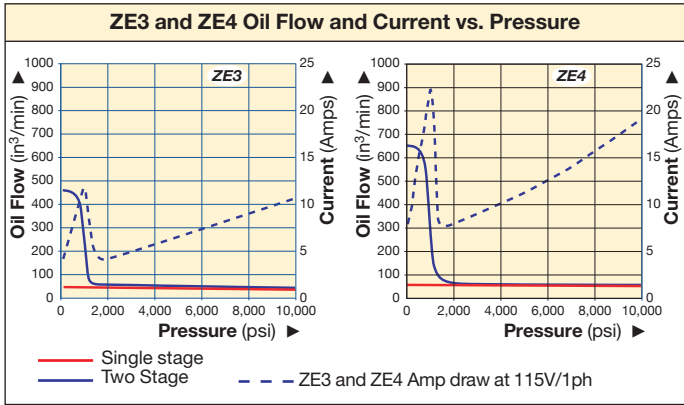

▼ PERFORMANCE CHART

Pump Series	Operation	Output Flow Rate (in ³ /min)				Available Reservoir Sizes (useable oil) (gal)	Motor Size		Relief Valve Adjustment Range (psi)	Sound Level (dBA)
		100 psi	700 psi	5,000 psi	10,000 psi		hp	RPM		
ZE3	Single-stage	43	43	42	40	1, 2, 2.5, 5, 10	1.0	1750	1000-10,000	75
	Two-stage	450	385	42	40					
ZE4	Single-stage	64	64	62	60	1, 2, 2.5, 5, 10	1.5	1750	1000-10,000	75
	Two-stage	650	600	62	60					
ZE5	Single-stage	128	126	123	120	2.5, 5, 10	3.0	1750	1000-10,000	75
	Two-stage	850	825	123	120					
ZE6	Single-stage	220	215	210	200	2.5, 5, 10	7.5	3450	1000-10,000	80
	Two-stage	900	890	210	200					

Output flow rate is listed at 60 Hz. Flow rate will be approximately 5/6 of these values at 50 Hz.

ZE-Series Pumps with 1 and 2 gallon-reservoir

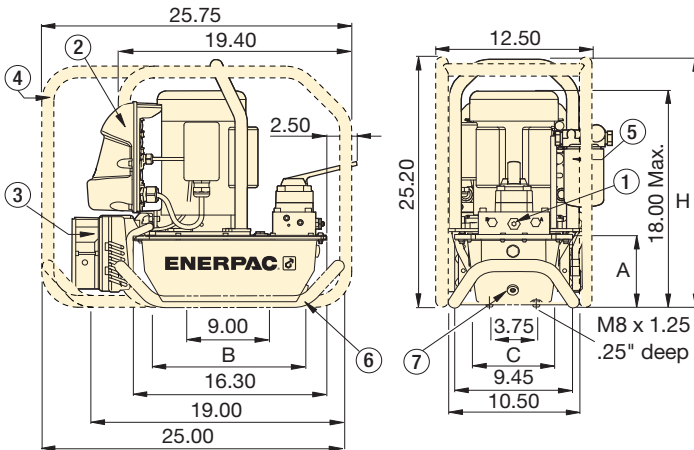

ZE-Series Pumps with 2.5, 5, 10-gallon reservoir

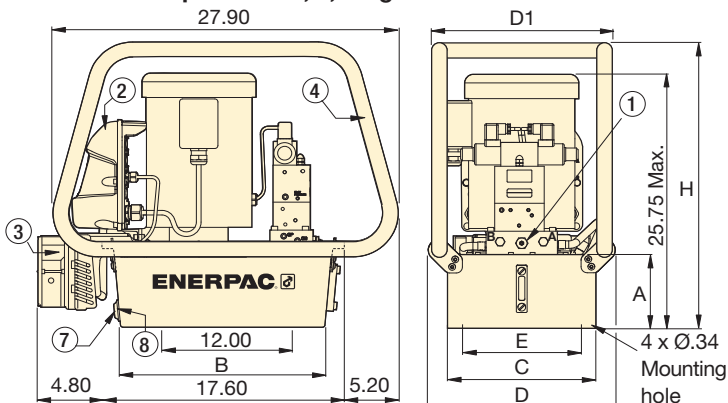

- ① User-adjustable relief valve on all manual and solenoid valves:
3/8" NPTF on A and B ports
1/4" NPTF on auxiliary ports
- ② Electric Box (Optional w/manual valve)
- ③ Heat Exchanger (Optional)
- ④ Roll Bar (Optional)
- ⑤ Return Line Filter (Optional)
- ⑥ Skid Bar (Optional)
- ⑦ Oil Drain
- ⑧ Oil Level/Temperature Switch (Optional)

Reservoir Size (useable oil) (gal)	ZE-Series Pump Dimensions (in)						
	A	B	C	D	D1	E	H
1.0	5.6	11.0	6.0	-	-	-	20.2
2.0	5.6	11.0	8.1	-	-	-	20.2
2.5	6.2	16.5	12.0	15.1	14.6	11.0	23.6
5.0	7.1	16.5	16.6	19.7	19.2	15.6	24.6
10.0	10.6	15.7	19.9	22.7	22.5	18.9	28.1

ZE Series Electric Pump Ordering Matrix

CUSTOM BUILD YOUR ZE SERIES PUMP

If the ZE Series pump that would best fit your application cannot be found in the chart on page 97, you can easily build your custom ZE Series pump here.

▼ This is how a ZE Series Pump model is built up:

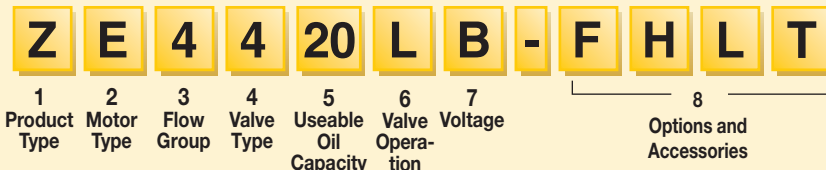

1 Product Type

Z = Pump Class

2 Prime movers

E = Induction Electric Motor

3 Flow Group

- 3** = 40 in³/min @ 10,000 psi
- 4** = 60 in³/min @ 10,000 psi
- 5** = 120 in³/min @ 10,000 psi¹⁾
- 6** = 200 in³/min @ 10,000 psi¹⁾

4 Valve Types

- 0** = No valve w/cover plate
- 1** = Dump (VE32D)
- 2** = 3-way/2-position manual (VM32)
- 3** = 3-way/3-position manual or electric (VM33 or VE33)
- 4** = 4-way/3-position manual or electric (VM43 or VE43)
- 6*** = 3-way/3-position locking manual w/po check (VM33L*)
- 7** = 3-way/2-position manual (VM22)
- 8** = 4-way/3-position locking manual w/po check (VM43L)
- 9** = 3-way/3-position manual, Venturi-Valve (VM33VAC)
- 10** = 3-way/3-position electric, Venturi-Valve (VE33VAC)

5 Useable Oil Capacity

- 04** = 1.0 gallon ²⁾
- 08** = 2.0 gallon ²⁾
- 10** = 2.5 gallon
- 20** = 5.0 gallon
- 40** = 10.0 gallon

6 Valve Operation

- D** = Dump valve (w/ pendant and LCD)
- L** = Manual valve (w/o pendant, w/ LCD)
- M** = Manual valve ⁶⁾ (w/o pendant or LCD)
- N** = No valve ⁶⁾ (no electrical box)
- S** = Solenoid valve (w/ pendant and LCD)
- W** = No valve (w/o pendant and LCD)

7 Voltages

- Single Phase
- B** = 115V 1 ph 50-60Hz ³⁾
 - E** = 115V 1 ph 50-60Hz ³⁾
 - E** = 208-240V 1 ph 50-60 Hz European Plug
 - I** = 208-240V 1 ph 50-60 Hz USA Plug
- Three Phase ⁶⁾
- M** = 190-200V 3ph 50-60Hz
 - G** = 208-240V 3ph 50-60Hz
 - W** = 380-415V 3ph 50-60Hz
 - K** = 440V 3ph 50-60Hz
 - J** = 460-480V 3ph 50-60Hz
 - R** = 575V 3ph 60Hz

8 Options and Accessories

(see page 100 for possibilities)

- F** = Filter
- G** = 0-15,000 psi gauge (2¹/₂" ⁶⁾)
- H** = Heat exchanger
- K** = Skid bar (1 and 2 gal. reservoirs only)
- L** = Level/temp switch ⁴⁾
- N** = No reservoir handles (includes lifting eyes)
- R** = Roll cage
- S** = Single stage
- T** = Pressure transducer ^{4) 7)}
- U** = Foot switch ⁴⁾

- 1) ZE5 and ZE6 series pumps only available with 3-phase motors.
- 2) 1 and 2-gallon reservoirs only available on ZE3 and ZE4-series pumps.
- 3) 115-volt pumps are supplied with 15-amp plug for intermittent use. 20-amp circuit recommended for frequent full pressure use.
- 4) These options require LCD electrical package. Pressure switch option only available on manual valves without locking valve. The LCD electrical package can accept either a pressure switch or pressure transducer, but not both.
- 5) Not available with 1 and 2-gallon reservoirs.
- 6) Standard Electric models with 3-phase motors are shipped without cord, motor starter or overload protection.
- 7) Pressure gauge not available on pump models with pressure transducer. Pressure transducer provides digital pressure readout on LCD display.

* Not available on ZE5 or ZE6 Series Pumps

ZE Series



Reservoir Capacity:

1.0-10.0 gal.

Flow at Rated Pressure:

40-200 in³/min.

Motor Size:

1.0-7.5 hp

Maximum Operating Pressure:

10,000 psi



Ordering Example 1

Model Number: ZE4420MB

ZE4420MB is a 60 in³/min, 10,000 psi pump with a 4-way, 3-position manual valve, a 5-gallon reservoir, operates on a 115 VAC 1-ph 50/60 Hz motor and includes standard electrical package.

Ordering Example 2

Model Number: ZE6440SG-HNU

ZE6440SG-HNU is a 200 in³/min, 10,000 psi pump with a 4-way, 3-position electric valve, a 10-gallon reservoir, operates on a 230 VAC, 3-ph, 50/60 Hz motor. It includes LCD electrical package and foot switch on 10-ft cord, no reservoir handles and the optional heat exchanger.



Assisted-Return Pumps

To improve productivity and plunger retraction, Enerpac offers valve configurations designed to accelerate your cylinder retraction speeds. ZU4 and ZE-Series pumps feature Venturi valve technology to facilitate the faster return of single-acting gravity return cylinders. See details on www.enerpac.com



Electric Box ¹⁾

- Back-lit LCD
- Pump usage information, hour and cycle counts
- Low-voltage warning and recording
- Self-test and diagnostic capabilities
- Pressure read-out ²⁾
- Auto-mode pressure setting ²⁾
- Information can be displayed in six languages ³⁾

- ¹⁾ Included on pumps with solenoid valves. Can be factory installed on pumps with manual valve
- ²⁾ When used with optional pressure transducer
- ³⁾ English, French, German, Italian, Spanish and Portuguese



Level/Temperature Switch ⁴⁾

- Shuts down pump before oil level reaches an unsafe level, avoiding damage due to cavitation
- Shuts down pump when unsafe oil temperature is reached
- Ideal if pump is used in remote area without visual access to oil level

⁴⁾ 24 V, requires Electric Box. Available for 2.5, 5 and 10 gallon reservoirs

Accessory Kit Model Number	Fixed Temperature Signal (°F)	Operating Temperature (°F)	Max. Pressure (psi)
ZLS-U4 *	75	40 - 230	150

* Add suffix **L** for factory installation, see ordering matrix.



Return Line Filter

- 25 micron nominal filter removes contaminants from return oil flow before allowing it back into tank
- Internal by-pass valve prevents damage if filter is dirty
- With maintenance indicator
- Replaceable filter element PF25

Accessory Kit Model Number	Maximum Pressure (psi)	Maximum Oil Flow (GPM)	By-pass Setting (psi)
ZPF *	200	12.0	25

* Add suffix **F** for factory installation, see ordering matrix.



Roll Cage

- For easy portability and hoisting
- Protects pump and electric box
- Available for all reservoir sizes

Accessory Kit Number	Fits on Reservoir
ZRC-04 *	1 and 2 gallon ¹⁾
ZRC-04H *	1 and 2 gallon ²⁾
ZRB-10 *	2.5 gallon
ZRB-20 *	5 gallon
ZRB-40 *	10 gallon

* Add suffix **R** for factory installation, see ordering matrix.
¹⁾ Without heat exchanger ²⁾ With heat exchanger



Skid Bar

- Provides easy two-hand lift
- Provides greater pump stability on soft or uneven surfaces

Accessory Kit Number	For ZE-Series Pumps with Reservoir	Weight (lbs)
SBZ-4 *	1-2 gal. w/o heat exchanger	4.9
SBZ-4L *	1-2 gal. with heat exchanger	5.5

* 1 and 2 gallon reservoirs only. Add suffix **K** for factory installation, see ordering matrix.



Foot Switch ⁵⁾

- Hands-free remote control on solenoid dump and 3-position valves
- With 10-foot cord

⁵⁾ 15 V, requires Electric Box

Accessory Kit Number	Can be used on ZE-Series Pumps with
ZCF-2 *	Solenoid VE-Series valves

* Add suffix **U** for factory installation, see ordering matrix.

ZE-Series, Factory Installed Options & Accessories



Pressure Transducer ¹⁾

- Displays pressure on LCD in bar, MPa or psi
- More accurate than analog gauge
- Calibration can be fine-tuned for certification
- Easy-viewing variable rate display
- “Set pressure” feature turns off motor at user defined pressure (or shifts valve to neutral on models with VE33/ VE43 valves)

¹⁾ 24 V, requires Electric Box

Accessory Kit Model number	Adjustable Pressure Range (psi)	Switch-point Repeatability	Dead-band (psi)
ZPT-U4 *	50-10,000	± 0,5%	50

* Add suffix **T** for factory installation, see ordering matrix.



Pendants ⁴⁾

- For pump types with valve operation “W” (No Valve, with Electric Box, without pendant)

⁴⁾ When ordering Enerpac VE-Series solenoid valve, the pendant must be ordered separately. Pendant connection to be plugged into electric box

Pendant Model Number	To be used with Solenoid Valve:
ZCP-1	VE32D
ZCP-3	VE32, VE33, VE43



Pressure Switch ^{2) 3)}

- Controls pump, monitors system
- Adjustable pressure 500-10,000 psi
- Includes glycerin filled, 15,000 psi pressure gauge, G2536L
- Accuracy ± 1,5% of full scale

²⁾ 24 V, requires Electric Box. Not available in combination with pressure transducer.

³⁾ Not available on LCD electronics

Accessory Kit Model number	Switch-point Repeatability	Deadband (psi)	Oil Ports (NPT)
ZPS-E3 *	± 2%	115-550	3/8"

* Add suffix **P** for factory installation, see ordering matrix.



Heat Exchanger ⁵⁾

- Removes heat from bypass oil to provide cooler operation
- Stabilizes oil viscosity, increasing oil life, and reduces wear of pump and other hydraulic components

⁵⁾ 24 VDC, requires electric box

Accessory Kit Model number	Fits on Reservoir	Weight (lbs)
ZHE-E04 *	1 and 2 gallon	9.0
ZHE-E10 *	2.5, 5, and 10 gallon	9.0

* Add suffix **H** for factory installation, see ordering matrix.



Options

Accessory Kits can be installed by customer. See chart below for options on Standard Electric (without electric box) or LCD Electric (with electric box). Refer to page 99 for ordering matrix.

ZE-Series Options	Factory Installed		Accessory Kits	
	Std. Electr.	LCD Electr.	Std. Electr.	LCD Electr.
Return Line Filter	F	F	ZPF	ZPF
Skid Bar ¹⁾	K	K	SBZ	SBZ
Roll Cage	R	R	ZRB	ZRB
Single-stage	S	S	-	-
Heat Exchanger	-	H	-	ZHE
Pressure Gauge ²⁾	G	G	-	-
Pressure Switch ³⁾	-	P	ZPS-E3	-
Pressure Transducer ⁴⁾	-	T	-	ZPT-U4
Level/Temp Switch ⁵⁾	-	L	-	ZLS-U4
Foot Switch ⁶⁾	-	U	-	ZCF-2

¹⁾ Available for 1 and 2 gallon reservoirs.

²⁾ Not available on pumps with pressure transducer.

³⁾ Includes 14,500 psi gauge. Only available on manual valves without locking feature.

⁴⁾ Electric box can accept either pressure switch or pressure transducer, but not both.

⁵⁾ Available for 2.5, 5, 10, gallon reservoirs.

⁶⁾ For control of solenoid dump and 3-position valves.



ZPT-U4 Pressure Transducer

More durable against mechanical and hydraulic shock than analog gauges.

- Digital pressure read-out provides accuracy of 5% of full scale.
- Easy-viewing variable rate display automatically varies increments between 44, 203, 508 and 2103 psi as rate of pressure change increases.
- “Set pressure” feature turns off motor at user defined pressure (or shifts valve to neutral on VE33 and VE43 valves).



ZHE-Series Heat Exchangers

Heat exchanger stabilizes oil temperature at 130° F at 70° F ambient temperature. Thermal transfer at 5 GPM and 70° F ambient temperature: 900 Btu/hour.

Do not exceed maximum oil flow of 7.0 GPM and maximum pressure of 300 psi. Not suitable for water-glycol or high water based fluids.

▼ Shown: PEM-8418



- Panel-mounted pressure gauge and adjustable relief valve for system pressure control
- Two-speed pump design, with high by-pass pressure, for rapid cylinder advance
- Dual-voltage motor (230/460 VAC, 3-phase, 60 Hz)
- Full length reservoir sight tube with integral thermometer for ease in monitoring oil level and temperature
- Low voltage controls to protect the pump operator



The Largest Pump for the Largest Jobs



Locking Valves

Pumps with VM-4 manual valves are available with VM-4L manual valves for positive load holding. Add suffix "L" to pump model number.

Page: 126



FS-34 Foot Control Switch

This 3-position switch allows hands-free control of the solenoid valve on the pump. Operates 24V and

115V valves that use the square electrical connector.



Hoses

Enerpac offers a complete line of high-quality hydraulic hoses. To ensure the integrity of your system, specify only genuine Enerpac hydraulic hoses.

Page: 132

◀ With similar specifications, a gasoline-powered EGM-8000 Series is shown here performing a synchronized lift.

8000-Series Electric Pumps



About the 8000 Series

The 8000 Series is the largest pump in the Enerpac line and the best choice to power most large size cylinders, multiple cylinder circuits, and applications where the need for high speed requires high flow rates.

The 8000 Series, with its large reservoir capacity, is best suited for large jobs and may be the only solution because of the required oil capacity.

For further application assistance see our "Yellow Pages", or consult your local Enerpac office.

PE Series



Reservoir Capacity:

25 gal.

Flow at Rated Pressure:

2.0 gal/min.

Motor Size:

12.5 hp

Maximum Operating Pressure:

10,000 psi

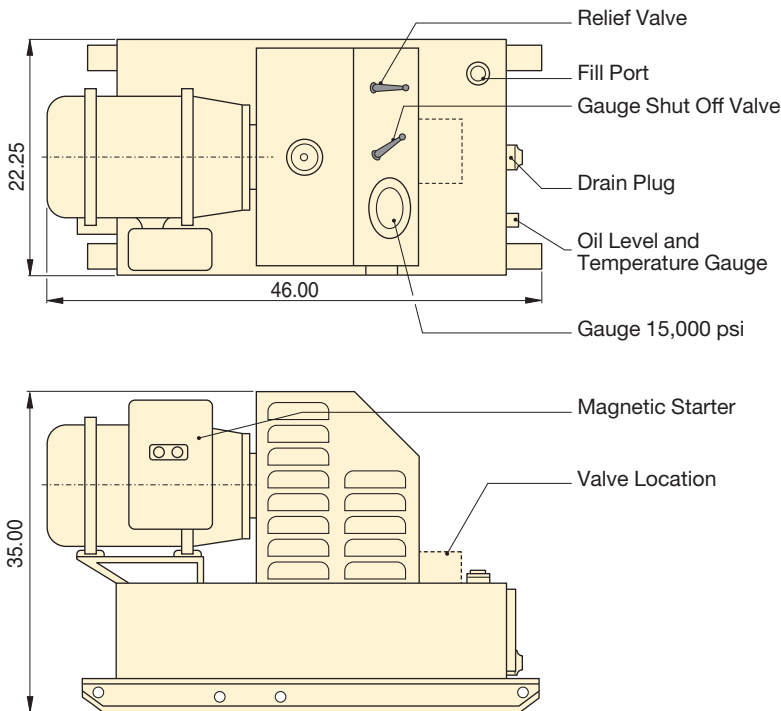

Dimensions shown in inches.



Speed Chart

To determine how an 8000-Series pump will operate your cylinder, see the Pump/Cylinder Speed Chart in the "Yellow Pages".

Page: 283

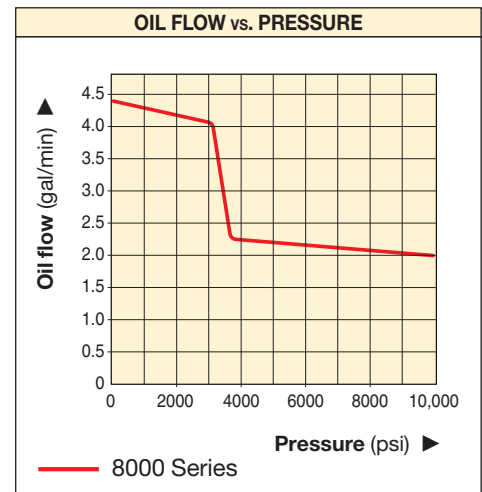

Used with Cylinder	Usable Oil Capacity (gal)	Model Number	Pressure Rating (psi)		Output Flow Rate (gal/min)		Valve Type	Valve Function	Current Draw (Amps)	Motor Voltage* (VAC)	Sound Level (dBA)	Weight (lbs)
			1st stage	2nd stage	1st stage	2nd stage						
Single-acting	18	PEM-8218	3,700	10,000	4.4	2.0	Manual (VM-2)	3-way, 2-pos.	33.0	230	78-84	720
	18	PEM-8218C	3,700	10,000	4.4	2.0			16.5	460	78-84	720
Double-acting	18	PEM-8418	3,700	10,000	4.4	2.0	Manual (VM-4)	4-way, 3-pos.	33.0	230	78-84	720
	18	PEM-8418C	3,700	10,000	4.4	2.0			16.5	460	78-84	720
	18	PER-8418	3,700	10,000	4.4	2.0	Solenoid (VE43)	4-way, 3-pos.	33.0	230	78-84	765
	18	PER-8418C	3,700	10,000	4.4	2.0			16.5	460	78-84	765

* Consult Enerpac for availability of other voltages.

PA-Series, Air Hydraulic Pumps

▼ Shown from top to bottom: PA-1150, PA-133



PA Series

Reservoir Capacity:

36-80 in³

Flow at Rated Pressure:

8 in³/min.

Maximum Operating Pressure:

10,000 psi



PC-66 Reservoir Conversion Kit

Double the reservoir capacity of your existing PA-133 with this easy to install conversion kit.

- Rugged construction – built for long life and easy service
- Swivel coupling simplifies hydraulic connection and pump operation
- Three-position treadle provides cylinder advance, hold and retract operation
- PA-133 operates in all positions for increased versatility in use and mounting
- Base mounting slots provided on PA-133

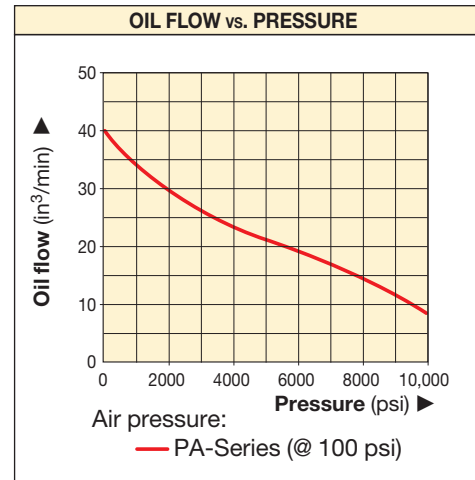

Dimensions shown in inches.

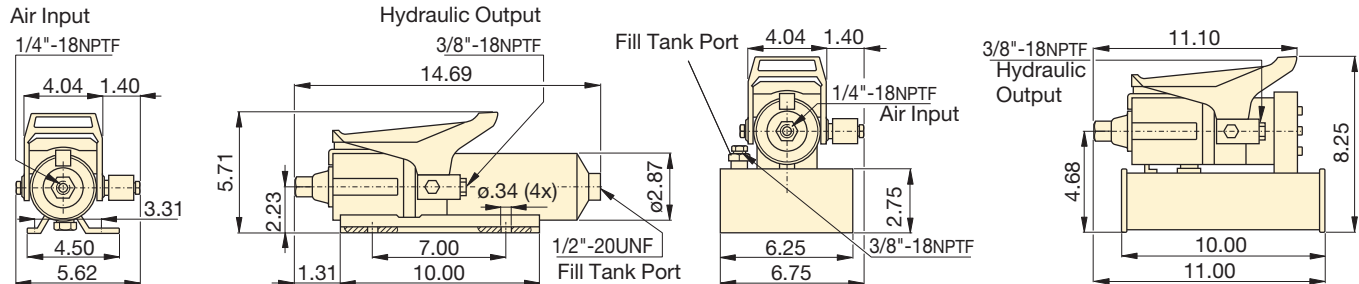

PA-133

PA-1150

Used with Cylinder	Usable Oil Capacity (in ³)	Model Number	Pressure Rating (psi)	Output Flow Rate (in ³ /min)		Valve Function	Air Pressure Range* (psi)	Air Consumption (scfm)	Sound Level (dBA)	Weight (lbs)
				No load	Load					
Single-acting	36	PA-133	10,000	40	8	Advance/Hold/Retract	60-120	9	85	12
	80	PA-1150	10,000	40	8	Advance/Hold/Retract	60-120	9	85	18

* Recommended Regulator-Filter-Lubricator: RFL-102

PAM-Series, Air Hydraulic Pumps

▼ Shown: PAM-1041



PAM Series

Reservoir Capacity:
1.0-2.0 gal.

Flow at Rated Pressure:
9 in³/min.

Maximum Operating Pressure:
10,000 psi



Locking Valves

Pumps with VM-4 manual valves are available with VM-4L manual locking valves instead. Add suffix "L" to pump model number.

Page: 126



Remote Air Valve

For remote operation of PAM-10 series air pumps. Permits either hand or foot operation.

Model number ¹⁾

VA-2

- Twin air motor configuration delivers high-flow performance in first stage, up to 200 psi, for rapid cylinder advance
- 1 and 2-gallon reservoirs for use with a wide range of cylinders
- Integral shroud protects air motors and provides easy portability

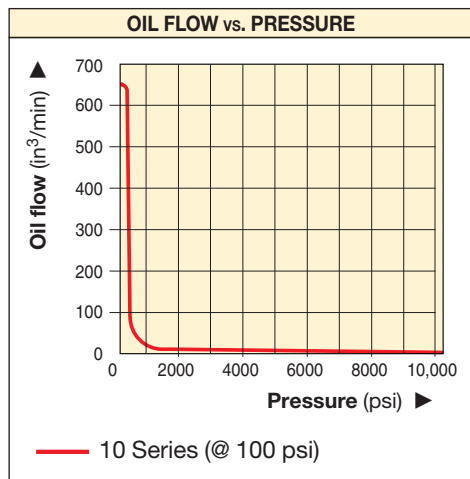
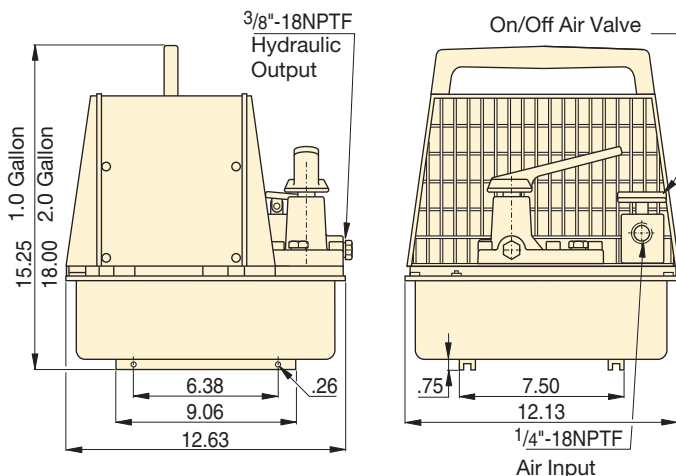

Used with Cylinder	Usable Oil Capacity (gal)	Model Number (with Shroud)	Pressure Rating (psi)	Output Flow Rate (in ³ /min)		Valve Function	Valve Model	Air Pressure Range* (psi)	Air Consumption (scfm)	Sound Level (dBA)	Weight (lbs)
				1 st stage	2 nd stage						
Single-acting	0.7	PAM-1021	10,000	650	9	Adv/Hold/Ret	VM-2	60-120	18	87	50
	2.0	PAM-1022	10,000	650	9	Adv/Hold/Ret	VM-2	60-120	18	87	60
Double-acting	0.7	PAM-1041	10,000	650	9	Adv/Hold/Ret	VM-4	60-120	18	87	50
	2.0	PAM-1042	10,000	650	9	Adv/Hold/Ret	VM-4	60-120	18	87	60

* Recommended Regulator-Filter-Lubricator: RFL-102

▼ Shown left to right: PAMG-1402N, PATG-1102N, PARG-1102N, PATG-1105N



Compact Air Over Hydraulic

- High efficiency cast aluminum air motor for increased life and reduced air consumption
- Fully serviceable air motor assembly
- Reinforced heavy-duty reservoir for applications in tough environments
- New generation air-saver piston with rugged one-piece design reduces air consumption and operating costs
- Return-to-tank port for use in remote valve applications
- Quiet – only 76 dBA with low air consumption of 12 scfm
- Operating air pressure: 40-125 psi, enables pump to start at extremely low pressure
- Internal pressure-relief valve provides overload protection



RFL-102 Regulator-Filter-Lubricator

Recommended for use with all air pumps. Provides clean, lubricated air and allows for air pressure adjustment. Steel bowl guards are standard.

Order model number ¹⁾

RFL102



Large Reservoir Models

The Turbo II Air Pump is also available with a larger reservoir: **PATG-1105N**, **PAMG-1405N**, and **PARG-1105N**.



Hoses

Enerpac offers a complete line of high-quality hydraulic hoses. To ensure the integrity of your system, specify only genuine Enerpac hydraulic hoses.

Page: **132**

▼ Easily operated by hand or by foot.



Used with Cylinder	Usable Oil Capacity (in ³)	Model Number
Single-acting	127	PATG-1102N*
	230	PATG-1105N
	127	PARG-1102N
	230	PARG-1105N
Double-acting	127	PAMG-1402N
	230	PAMG-1405N

* Available as set. See note on next page.

Turbo II Air Hydraulic Pumps

PATG PARG PAMG Series



Reservoir Capacity:
150-305 in³

Flow at Rated Pressure:
5-10 in³/min.

Maximum Operating Pressure:
10,000 psi

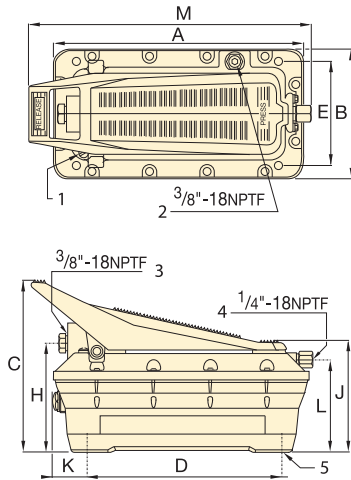

PATG-1102N and PATG-1105N

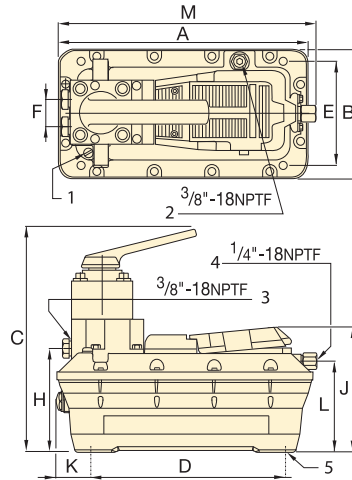

PAMG-1402N and PAMG-1405N

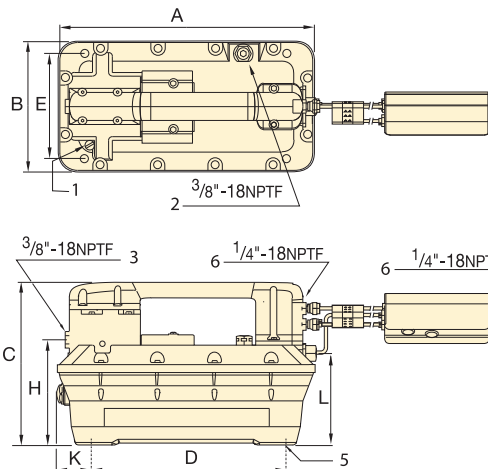

PARG-1102N and PARG-1105N

- ① Filtered "Permanent" Tank Vent
- ② Return-to-Tank/Auxiliary Vent/Fill Tank Port
- ③ Hydraulic Output
- ④ Swivel Air Input with Filter
- ⑤ 4 Mounting Holes for #10 thread forming screw. Max. depth into reservoir = .75"
- ⑥ Air Input Options



The PATG-models use a foot or hand-operated treadle to control air and valve functions.

The PAMG-models use a treadle with a locking feature and a 4-way manual valve.

The PARG-models use a 15-ft. pendant hose for convenient one-man operation.

OIL FLOW vs. PRESSURE

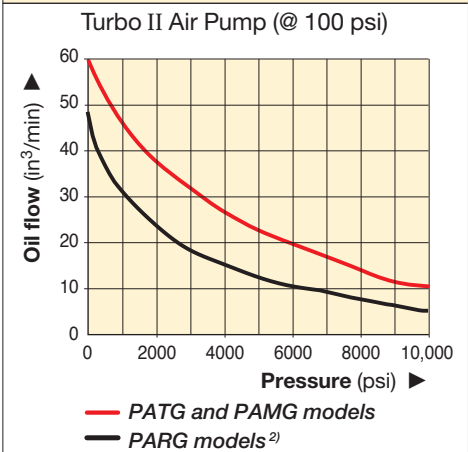

Pressure Rating (psi)	Output Flow Rate (in ³ /min)		Model Number	Valve Function	Air Pressure Range (psi)	Air Consumption (scfm)	Sound Level (dBA)
	No load	Load					
10,000	60	10	PATG & PAMG PARG	Advance/ Hold/ Retract	40-125	12	76
10,000	51 ¹⁾	6 ¹⁾			40-125	12	76
10,000	48 ²⁾	5 ²⁾			40-125	8	76

¹⁾ Air supply connected at pendant. ²⁾ Air supply connected at pump shown on flow curve.

Dimensions											Weight (lbs)	Model Number
A	B	C	D	E	F	H	J	K	L	M		
12.33	6.49	8.29	9.04	4.00	—	5.15	5.75	1.65	4.43	13.62	18	PATG-1102N*
15.60	7.92	8.22	9.04	4.00	—	5.08	5.75	3.28	4.41	17.20	22	PATG-1105N
12.33	6.49	7.88	9.04	4.00	—	5.15	—	1.65	4.43	—	22	PARG-1102N
15.60	7.92	7.88	9.04	4.00	—	5.08	—	3.28	4.41	—	26	PARG-1105N
12.33	6.49	10.50	9.04	4.00	1.42	5.23	6.00	1.65	4.43	12.60	24	PAMG-1402N
15.60	7.92	10.50	9.04	4.00	1.42	5.19	6.00	3.28	4.41	15.94	28	PAMG-1405N

▼ Shown: **XA11G**



- Higher oil flow for increased productivity
- Variable oil flow and fine metering for precise control
- Ergonomic design for less operator fatigue
- Closed hydraulic system prevents contamination and allows pump usage in any position
- Pedal lock function for retract position
- External adjustable pressure setting valve
- ATEX Certified.* Includes ground screw for explosion protection

* See explanation of ATEX Certification in "Yellow Pages."



▼ Easily operated by foot. No need to fully lift up foot - rest body weight on heel, resulting in a hands-free and stable working position.



Control and Ergonomics



Optional Pressure Gauge

Integrated gauge with calibrated scale reading in psi, bar and MPa for actual pressure reading.



Optional 4-Way 3-Position Valve

For powering double-acting hydraulic cylinders and tools.



Optional 1/2 Gallon Reservoir

Double oil capacity for powering larger hydraulic cylinders and tools.



Pedal Safety Guard

Customer installed frame protects both pedals against accidental activation.

Order model number ¹⁾

XPG1



"Joy-stick" Lever Kit

Customer installed set of handles for manual operation of both pedals.

Order model number ¹⁾

XLK1



Hydraulic Swivel Connector

Customer installed swivel connector for optimal orientation of the hydraulic hose.

Order model number ¹⁾

XSC1

¹⁾ Accessories must be ordered separately.

Air Driven Hydraulic Pumps



PRODUCTION APPLICATION

XA11 pump is used with a 13-ton hollow cylinder to compress and position diesel engine valve springs.

The operator benefits from the fine metering capabilities to apply the mandatory precise stroke and force.

XA Series



Reservoir Capacity:
61-122 in³

Flow at Rated Pressure:
15 in³/min.

Air Consumption:
10-35 scfm

Maximum Operating Pressure:
10,000 psi

▼ XA-SERIES PERFORMANCE CHART

Maximum Pressure (psi)	Output Flow Rate (in ³ /min)		Pump Series	Valve Function	Dynamic Air Pressure (psi)
	No load	Load			
10,000	120	15	XA1	Advance/Hold/Retract	30-125

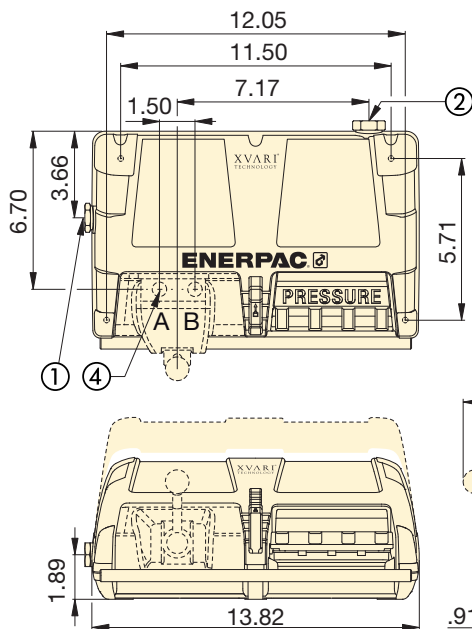

- ① 3/8"-18 NPTF Oil Outlet
- ② 1/4"-18NPTF Air Inlet
- ③ 4/3 Optional Control Valve
- ④ 3/8"-18 NPTF Oil Outlet

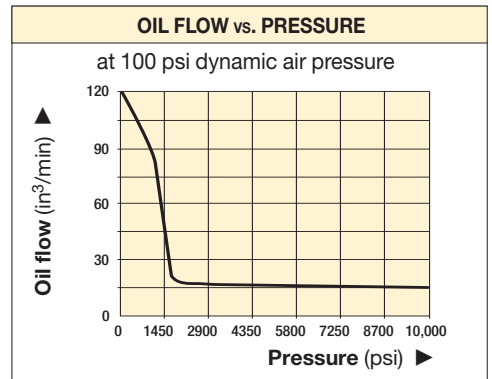

Regulator-Filter-Lubricator

Recommended for use with all XA-Series Air pumps. Provides clean, lubricated air and allows for air pressure adjustment.

Order model number ¹⁾

RFL102

▼ SELECTION CHART

For Use With Cylinder Tool	Usable Oil Capacity (in ³)	Model No. ¹⁾	Pressure Gauge	3-Way, 3-Position Valve	4-Way, 3-Position Valve	Dimensions (in)			Weight (lbs)
						H1	H2	L	
Single-acting	61	XA11 ²⁾	–	•	–	5.98	–	–	19.0
	122	XA12 ²⁾	–	•	–	–	6.69	–	22.4
Single-acting	61	XA11G	•	•	–	5.98	–	–	19.4
	122	XA12G	•	•	–	–	6.69	–	22.9
Double-acting	61	XA11V	–	–	•	5.98	–	10.98	22.3
	122	XA12V	–	–	•	–	6.69	10.98	25.7
Double-acting	61	XA11VG	•	–	•	5.98	–	10.98	22.7
	122	XA12VG	•	–	•	–	6.69	10.98	26.2

¹⁾ High-flow coupler CR400 and accessories must be ordered separately.

²⁾ Available as cylinder pump set, see page 52.

▼ Shown: ZA4208MX, ZA4420MX



Z Tough. Dependable. Innovative. CLASS



ATEX Certified

See explanation of ATEX certification in the “Yellow Pages.”



Page: 273



Speed Chart

To determine how a ZA Series pump will operate your cylinder, see the Pump/Cylinder Speed Chart in the “Yellow Pages”.

Page: 283



Hoses

Enerpac offers a complete line of high-quality hydraulic hoses. To ensure the integrity of your system, specify only genuine Enerpac hydraulic hoses.

Page: 118

- Features Z-Class high efficiency pump design, higher oil flow and bypass pressure
- Two-speed operation and high by-pass pressure reduces cycle time for improved productivity
- Internal relief valves. One is factory set for overload protection while the second is user adjustable for pre-setting maximum system pressure
- Sight gauge on 1 and 2-gallon and level gauge on 2.5, 5 and 10-gallon reservoirs allow quick and easy oil level monitoring
- Optional heat exchanger warms exhaust air to prevent freezing and cools the oil

ZA4 Performance		
Dynamic Air Pressure Range	Air Consumption	Sound Level
(psi)	(scfm)	(dBA)
60-100	20-100	94-97

Used with Cylinder	Usable Oil Capacity (gal)	Valve Model Number ²⁾	Valve Function	Model Number	Output Flow Rate ¹⁾			
					(in ³ /min)			
					100 psi	700 psi	5,000 psi	10,000 psi
Single-acting	1.0	Manual VM32	Advance/Retract	ZA4204MX	850	675	110	80
	1.75			ZA4208MX	850	675	110	80
	5.0			ZA4220MX	850	675	110	80
Double-acting	1.0	Manual VM43	Advance/ Hold/ Retract	ZA4404MX	850	675	110	80
	1.75			ZA4408MX	850	675	110	80
	2.5			ZA4410MX	850	675	110	80
	5.0			ZA4420MX	850	675	110	80
	10.0			ZA4440MX	850	675	110	80

1) Actual flow will vary with air supply

2) See valve section for hydraulic symbols and details

ZA-Series Air Hydraulic Pump Ordering Matrix

CUSTOM BUILD YOUR ZA4 AIR PUMP

▼ This is how a ZA-Series Pump model number is built up:



1 Product Type
2 Motor Type
3 Flow Group
4 Valve Type
5 Usable Oil Capacity
6 Valve Operation
7 Voltage
8 Options

1 Product Type

Z = Pump class

2 Motor Type

A = Air motor

3 Flow Group

4 = 80 in³/min@10,000 psi

4 Valve Type

0 = No valve with cover plate
2 = 3-way, 2-position (VM32)
3 = 3-way, 3-position (VM33)
4 = 4-way, 3-position (VM43)
6 = 3-way, 3-position, locking (VM33L)
7 = 3-way, 2-position (VM22)
8 = 4-way, 3-position, locking (VM43L)

5 Usable Oil Capacity

04 = 1.0 gallon
08 = 1.75 gallon
10 = 2.5 gallon
20 = 5.0 gallon
40 = 10.0 gallon

6 Valve Operation

M = Manual valve
N = No valve

7 Voltage

X = Not applicable

8 Options

(Specify in alphabetical order)

F = Filter
G = 0-15,000 psi gauge (2 1/2")
H = Heat exchanger*
K = Skid bar*
N = No reservoir handles (includes lifting eyes; 2.5, 5, 10 gallon only)
R = Roll bars

* (1 and 2 gallon reservoirs only)

Ordering Example

Model Number: ZA4208MX-FHK

ZA4208MX-FHK is an air operated pump with a 3-way, 2-position manual valve, a 2.0 gallon reservoir, filter, heat exchanger and skid bar.

ZA Series



Reservoir Capacity:

1.0-10.0 gal.

Flow at Rated Pressure:

80 in³/min.

Maximum Operating Pressure:

10,000 psi

- ① User adjustable relief valve on all manual valves
 - ② Air inlet 1/2" NPTF
 - ③ Return Line Filter (optional)
 - ④ Oil Sight Gauge
 - ⑤ Roll Cage (optional)
 - ⑥ Oil Drain
 - ⑦ Lifting eyes (4) (optional)
 - ⑧ Handles
- Skid Bar (Model No. SBZ-4) (optional)

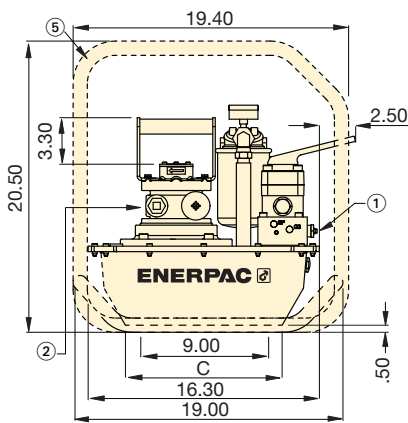

1 and 1.75 gallon reservoirs

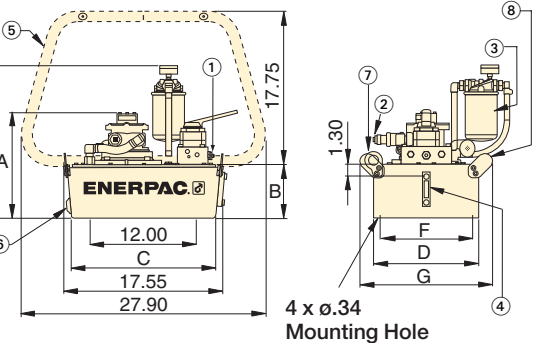
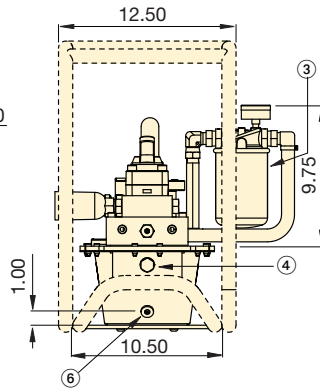

2.5, 5, 10 gallon reservoirs

Dimensions (in)							Weight (incl. oil) (lbs)
A	B	C	D	E	F	G	
11.6	5.6	11.0	6.0	15.4	-	-	65.5
11.6	5.6	11.0	8.1	15.4	-	-	75.7
13.0	7.1	16.5	16.6	16.0	15.6	18.4	112.7
11.6	5.6	11.0	6.0	15.4	-	-	66.7
11.6	5.6	11.0	8.1	15.4	-	-	76.9
12.0	6.1	16.5	12.0	16.0	11.0	15.1	87.1
13.0	7.1	16.5	16.6	16.9	15.6	18.4	113.9
16.5	10.6	15.7	19.9	20.4	18.9	23.0	164.6

OIL FLOW vs. PRESSURE

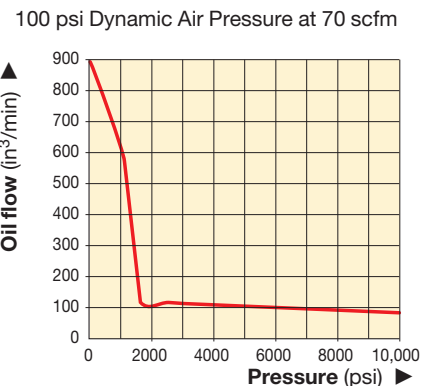

ZG5/ZG6 Gasoline Hydraulic Pumps

▼ Shown: ZG5420MX-R



Z Tough.
Dependable.
Innovative.
CLASS

- Features Z-Class high-efficiency pump design, higher oil flow and bypass pressure
- Two-speed operation reduces cycle time for improved productivity
- Full-sight oil level glass on all reservoirs allow quick and easy oil level monitoring
- ZG5 is available in two 4-cycle engine sizes: 7.1 ft.lbs Honda and 8.5 ft.lbs Briggs & Stratton

i **Speed Chart**
To determine how a ZG Series pump will operate your cylinder, see the Pump/Cylinder Speed Chart in the “Yellow Pages”.

Page: **283**

i **ZG-Series, Gasoline Pump Performance**
Elevation can affect the performance of any gasoline engine. ZG-Series pumps are designed to develop rated performance at elevations up to 4921 ft. For applications above this elevation please consult your Enerpac office.

 **User-Adjustable Relief Valve**
All VM-Series directional valves have a user adjustable relief valve to allow the operator to easily set the optimum working pressure.

▼ **SELECTION CHART**

Used with Cylinder	Usable Oil Capacity (gal)	Valve Model Number	Valve Function	Model Number with Roll Cage	Output Flow Rate (in ³ /min)				Sound Level (dBA)	Motor Manufacturer* (ft-lbs)
					at 100 psi	at 700 psi	at 5000 psi	at 10,000 psi		
Single-Acting	2.5	VM33	Advance/ Hold/ Retract	ZG5310MX-R	700	650	110	100	88 - 93	Honda
	5.0			ZG5320MX-R	700	650	110	100		
Double-Acting	2.5	VM43		ZG5410MX-R	700	650	110	100	88 - 93	
	5.0			ZG5420MX-R	700	650	110	100		
Single-Acting	2.5	VM33		ZG5310MX-BR	400	380	110	100	91 - 95	Briggs & Stratton *
	5.0			ZG5320MX-BR	400	380	110	100		
Double-Acting	2.5	VM43		ZG5410MX-BR	400	380	110	100	91 - 95	
	5.0			ZG5420MX-BR	400	380	110	100		
	10.0	VM43L	ZG5840MX-BR	400	380	110	100	91 - 95		

*To order Briggs & Stratton motor, place a “B” suffix in the model number.

Gasoline Hydraulic Pumps

CUSTOM BUILD YOUR ZG AIR PUMP

▼ This is how a ZG-Series Pump model number is built up:

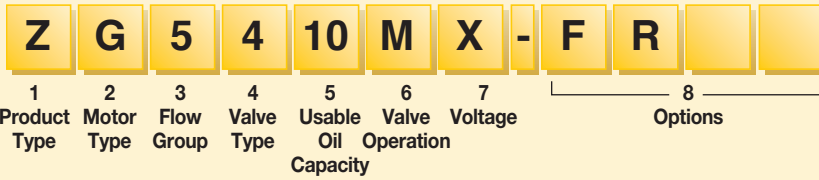

1 Product Type

Z = Pump class

2 Motor Type

G = Gasoline Engine

3 Flow Group

5 = 100 in³/min@10,000 psi

6 = 200 in³/min@10,000 psi (see page 114)

4 Valve Type

0 = No valve with coverplate ¹⁾

2 = 3-way, 2-position (VM32)

3 = 3-way, 3-position (VM33)

4 = 4-way, 3-position (VM43)

6 = 3-way, 3-position, locking (VM33L)

8 = 4-way, 3-position, locking (VM43L)

¹⁾ For remote valve mounting order **BSS1090** high pressure connecting plate.

5 Usable Oil Capacity (Reservoir Size)

10 = 2.5 gallon

20 = 5.0 gallon

40 = 10.0 gallon

6 Valve Operation

M = Manual valve

N = No valve

7 Voltage

X = Not applicable

8 Options

(Specify in alphabetical order)

B = Briggs & Stratton gasoline engine

F = Return Line Filter

G = 15,000 psi gauge

N = No reservoir handles (includes lifting eyes; 2.5, 5, 10 gallon only)

R = Roll bars

Ordering Example

Model Number: **ZG5420MX-FR**

This is a 10,000 psi hydraulic pump, with a 4/3 manual valve, 2.5 gallon reservoir, with a 7.1 ft-lbs Honda gasoline engine pump, return-line filter and roll bar.

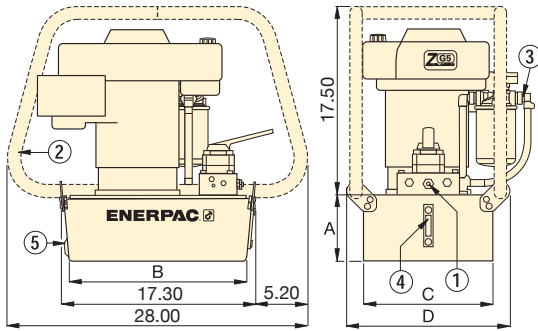

- ① User-adjustable relief valve on all manual valves. 3/8" NPTF on A and B ports; 1/4" NPTF on auxiliary ports.
- ② Roll Bar (optional)
- ③ Return Line Filter (optional)
- ④ Oil Level Gauge
- ⑤ Oil Drain

Relief Valve Adjustment Range (psi)	Reservoir Size (gal)	ZG5 Dimensions (in)				Weight (lbs)	Model Number with Roll Cage
		A	B	C	D		
1000-10,000	2.5	6.1	16.5	12.0	15.1	113.6	ZG5310MX-R
	5.0	7.1	16.3	16.6	19.7	140.9	ZG5320MX-R
	2.5	6.1	16.5	12.0	15.1	113.6	ZG5410MX-R
	5.0	7.1	16.3	16.6	19.7	141.0	ZG5420MX-R
1000-10,000	2.5	6.1	16.5	12.0	15.1	111.0	ZG5310MX-BR
	5.0	7.1	16.3	16.6	19.7	138.3	ZG5320MX-BR
	2.5	6.1	16.5	12.0	15.1	111.1	ZG5410MX-BR
	5.0	7.1	16.3	16.6	19.7	138.4	ZG5420MX-BR
	10.0	10.6	15.7	19.8	21.9	189.6	ZG5840MX-BR

ZG5 Series



Reservoir Capacity:

2.5 - 5 - 10 gal.

Flow at Rated Pressure:

100 in³/min.

Engine Size:

7.1 and 8.5 Ft.lbs

Maximum Operating Pressure:

10,000 psi



High-Pressure Hoses

Enerpac offers a complete line of high-quality hydraulic hoses. To ensure the integrity of your system, specify only genuine Enerpac hydraulic hoses.

Page: 132



ZG6-Series 17.0 Ft-lb Pump

The ZG6 pump has a 200 in³/min. oil flow at 10,000 psi, Briggs & Stratton 4-cycle gasoline engine with electric start and 12 volt charge output for accessories.

Page: 114

OIL FLOW vs. PRESSURE

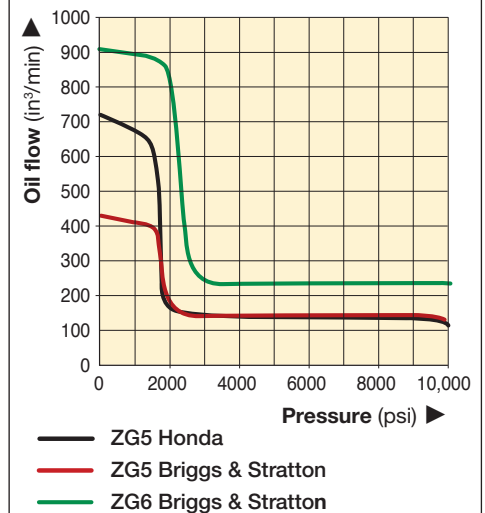

▼ Shown: ZG6440MX-BCFH



ZG6 Series

Reservoir Capacity:

10 gal.

Flow at Rated Pressure:

200 in³/min.

Engine Size:

17.0 Ft.lbs

Maximum Operating Pressure:

10,000 psi



- Features Z-Class high-efficiency pump design:
 - higher oil flow and bypass pressure
 - patented balanced rotating pump components to reduce vibration
 - replaceable piston check valves that increase service life of pump components
- Two-speed operation reduces cycle time for improved productivity
- Full-sight oil level glass on all reservoirs allow quick and easy oil level monitoring
- Sturdy wheeled cart allows transport over uneven terrain and features collapsible handles
- Dual forced-air heat exchangers stabilizes hydraulic oil temperature
- Roll cage for easy portability and hoisting, protects pump
- Briggs & Stratton 17 ft.lbs engine with electric start, pressurized oil and 16-amp charge output for accessories



Other Options Available

The ZG5/ZG6 pumps are available in a wide range of configurations and options.

Contact Enerpac for further information.



User Adjustable Relief Valve

All VM-Series directional valves have a user adjustable relief valve to allow the operator to easily

set the optimum working pressure.

Used with Cylinder	Usable Oil Capacity (gal)	Valve Model Number	Valve Function	Model Number	Motor Manufacturer*	Motor Size (Ft.lbs)	Weight (lbs)
Double-Acting	10.0	VM43	Advance/Hold/Retract	ZG6440MX-BCFH	Briggs & Stratton	17.0	334.0

8000-Series Gasoline Pumps

▼ Shown: EGM-8418



EGM Series

Reservoir Capacity:

25 gal.

Flow at Rated Pressure:

1.5 gal/min.

Motor Size:

18 hp

Maximum Operating Pressure:

10,000 psi



Locking Valves

Pumps with VM-4 manual valves are available with VM-4L manual valves for positive load holding. Add suffix "L" to pump model number.

Page: 126

- Industrial grade 18 hp twin-cylinder motor
- Panel mounted pressure gauge and adjustable relief valve for system pressure control
- Two-speed pump design with high by-pass pressure for rapid cylinder advance
- Built in oil temperature and oil level gauge
- External adjustable relief valve (1,200-10,000 psi) allows control of operating pressure without opening the pump
- Integral priming circuit guarantees quick starts after transport

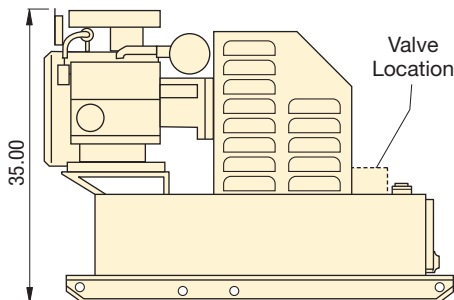
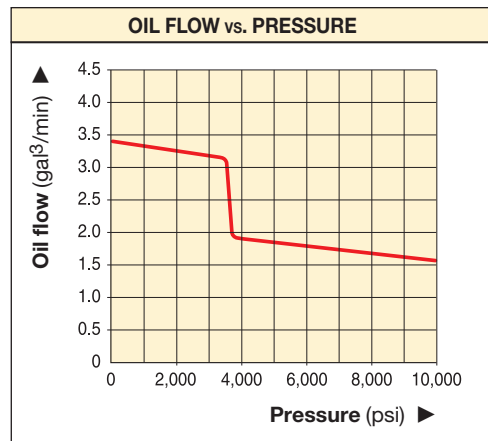

Side View

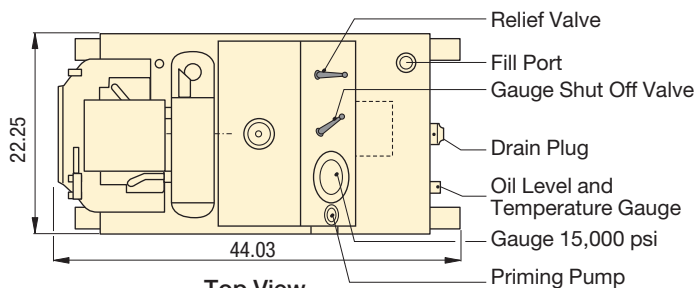

Top View

Used with Cylinder	Usable Oil Capacity (gal)	Model Number	Pressure Rating (psi)		Output Flow Rate (gal/min)		Valve Type	Valve Function	Sound Level (dBA)	Weight (lbs)
			1 st stage	2 nd stage	1 st stage	2 nd stage				
Single-acting	18	EGM-8218	3,700	10,000	3.4	1.5	3-way, 2-pos.	Adv./Retr.	94	890
Double-acting	18	EGM-8418	3,700	10,000	3.4	1.5	4-way, 3-pos.	Adv./Hold/Retr.	94	890

▼ Shown: Level Lift System



The Safe, Easy Solution for Multi-Point Lifts



Level Lift System

Enerpac's **Level Lift** is offered as a fully configured system including pump, hoses, gauges, and cart. *Excludes hydraulic cylinders.*

- Lifts and lowers uneven loads*
- Robust solution for demanding field use conditions—eliminates the need for electronics or sensors at each lift point
- Controls up to four lift points
- Single point of control reduces risk of operator miscommunication
- Simple, intuitive, easy-to-operate design

Patents pending

*Requires cylinders with matching effective areas



Pendant

The **Level Lift System** features an easy-to-use 3-button pendant control.



Gauges

Gauges are conveniently located on the cart for easy monitoring by the operator.



◀ *Level Lift System provided a safe, fast lifting solution during the rebuild of an off-highway vehicle.*



How Level Lift Works

When the Level Lift System is operated, uneven loads are moved evenly, during both lifting and lowering operations.

The output flow from the pump is directed to the Level Lift Valve via the Lift/Lower valve. The Level Lift valve contains small pistons, which on each cycle, send a fixed volume of oil to each cylinder as it is lifting or lowering.

This allows each cylinder to be raised or lowered by the same amount regardless of the distribution of the weight, or the resulting pressure on each cylinder — **each cylinder must have the same effective area.**

LL Series



Number of Lift Points:

4 points

Maximum Operating Pressure:

10,000 psi

Level Lifting and Lowering of Uneven Loads

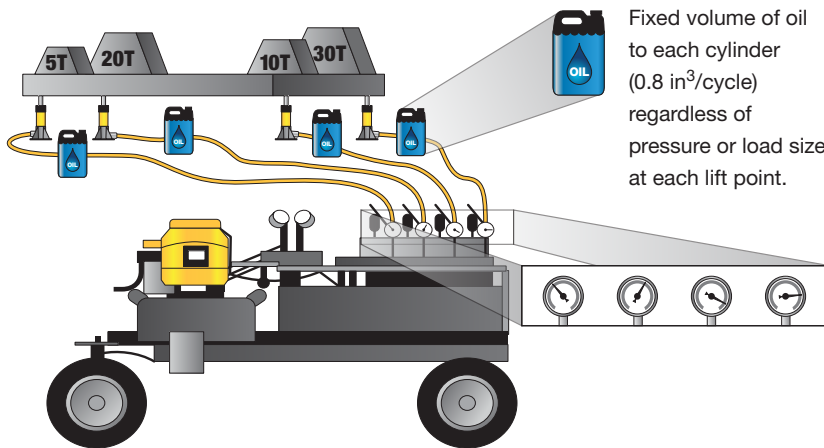

Dimensions are in inches.

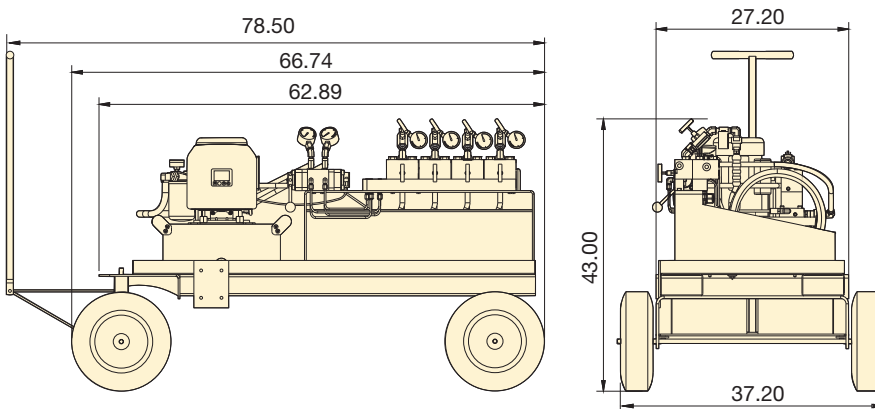

Model Number	Voltage	Oil Displacement	Wt.
		(Per cycle of Level Lift Valve)	
		(in ³)	(lbs)
LL4CE	208-240V, 1 ph, 50 Hz	0.80	651
LL4CB	115V, 1 ph, 60 Hz	0.80	651



Cart Features

- Field proven, preprogrammed ZE4 semi-automated pump with 5-gallon reservoir
- Pendant control
- Simple Lift/Lower Valve (for lifting and lowering)
- Stores four, 50-foot long x 3/8" internal diameter hoses (included)
- Built-in forklift runners for easy transportation
- Large diameter pneumatic tires for easy maneuverability and positioning
- Cart-locking mechanism to prevent unintended movement



Cylinder Compatibility

The **Level Lift System** is compatible with a wide range of Enerpac single-acting cylinders.

Not recommended for use with cylinders lower than 10-ton capacity or CLP, RSM and RCS-Series Cylinders.

Contact Enerpac for further details.

▼ SFP421SJ and SFP404SJ (Gauges and retract valves not shown)



Multiple Outlets with Equal Flow for Lifting and Lowering



Typical Split-Flow Pump Applications

For lifting and lowering applications on multiple points, Split-Flow Pumps are a far better alternative than using independently operated pumps. Where synchronization of maximum 4% is acceptable, Split-Flow Pumps are a safe and economical solution.

The SFP-Series pumps feature both single and synchronized multiple outlet control either through joystick or pendant operation.

Application examples:

- Bridge deck lifting for bearing maintenance
- Stage lifting in construction and shipbuilding
- Skidding to move structures and buildings
- Levelling of constructions like wind turbines

- 2, 4, 6 or 8 split-flow outlets
- Individual or simultaneous operation of valves, with advance/hold/retract function
- Joystick (manual) controlled or pendant (solenoid) controlled valves
- Flow per outlet ranging from 20 to 305 in³/min at 10,000 psi
- For double- and single-acting cylinders
- Adjustable pressure relief valve per circuit
- Reservoir: 5, 10 or 40 gallons
- All models include pressure gauges



Remote Control Pendant

Split-Flow Pumps with solenoid valves include a remote pendant with selector switches for each individual outlet, allowing single or multiple cylinder operation.



Hoses and Couplers

Enerpac offers a complete line of high-quality hydraulic hoses. To ensure the integrity of your system, specify only genuine Enerpac System Components.

Page: 132

▼ Step-by-step stage lifting an old windmill using double-acting RR-506 cylinders powered by a Split-Flow Pump.



10,000 psi, Split-Flow Pumps

SFP Series



Reservoir Capacity:
5, 10 or 40 gallons

Split Flow Outlets:
2, 4, 6 or 8 outlets

Flow at Rated Pressure:
20 - 305 in³/min

Maximum Operating Pressure:
10,000 psi

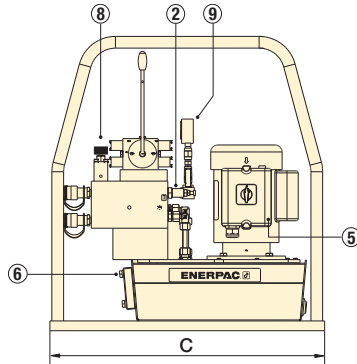
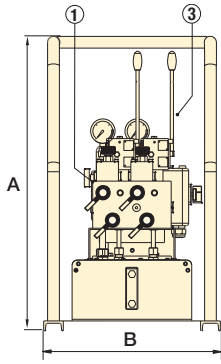

◀ SFP-Series with 5-gallon reservoir (shown with two split-flow outlets)

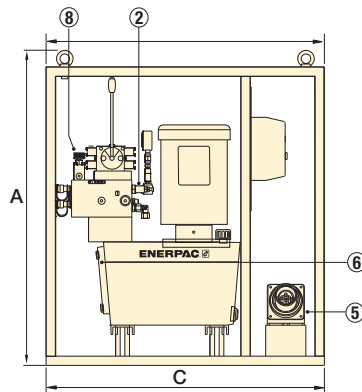
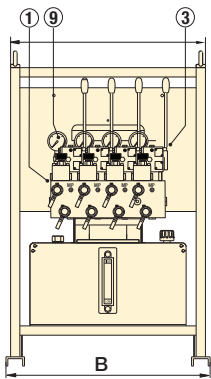

◀ SFP-Series with 10 gallon reservoir (shown with 4 split-flow outlets)

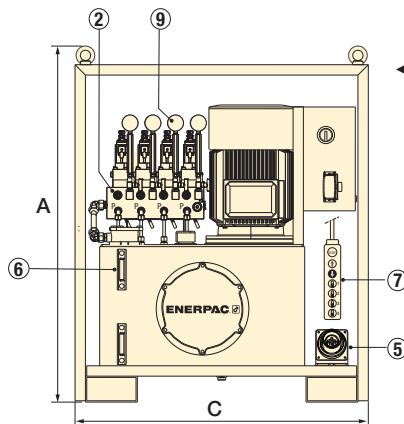
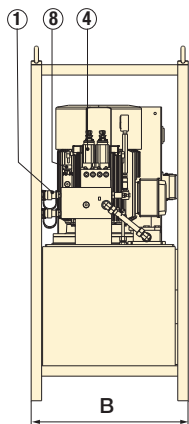

◀ SFP-Series with 40-gallon reservoir (shown with 4 split-flow outlets)

- ① Manifold with split-flow outlets and CR-400 couplers
- ② Adjustable pressure relief valve per circuit
- ③ Manual 4/3 control valves with joysticks
- ④ Solenoid 4/3 control valves (24 VDC)
- ⑤ Power Receptacle
- ⑥ Oil sight gauge(s)
- ⑦ Remote control pendant with 30 ft. cord
- ⑧ Flow control valve
- ⑨ Hydraulic gauge



Lifting Cylinders

For a complete line of Enerpac cylinders, see the Cylinder and Lifting Products in our catalog.

Page: 5

Number of Split Flow Outlets	Reservoir Size (gal)	Oil Flow per Outlet @ 10,000 psi (in ³ /min)	Pump Model Number 4/3 Valve Operation Advance/Hold/Retract		Motor Size 460 V - 3ph 60 Hz (hp)	Dimensions (in)			Weight (lbs)
			Manual (Joystick)	24 V Solenoid (Pendant)		A	B	C	
2	5	20	SFP 202MB	—	1.0*	29.5	17.7	27.5	190
	10	94	SFP 213MJ	SFP 213SJ	7.5	40.1	26.0	35.4	529
	40	203	SFP 228MJ	SFP 228SJ	10	54.0	23.8	44.5	1076
	40	305	SFP 242MJ	SFP 242SJ	15	54.0	23.8	44.5	1160
4	10	33	SFP 404MJ	SFP 404SJ	7.5	40.1	26.0	35.4	529
	40	65	SFP 409MJ	SFP 409SJ	7.5	54.0	23.8	44.5	1047
	40	101	SFP 414MJ	SFP 414SJ	10	54.0	23.8	44.5	1076
	40	153	SFP 421MJ	SFP 421SJ	15	54.0	23.8	44.5	1160
6	10	33	SFP 604MJ	SFP 604SJ	7.5	40.1	26.0	35.4	529
	40	94	—	SFP 613SJ	15	54.0	31.7	47.2	1213
8	40	94	—	SFP 813SJ	20	54.0	31.7	47.2	1300

* 115V-1 ph, 60 Hz

▼ EVO-8 (shown with 4 cylinders and stroke sensors, (sold separately))



- Lifting system to control 4, 8 or 12 lifting points (12 points for Standard EVO only)
- Intuitive user interface provides easy set-up and control with multiple lifting options
- Accuracy of up to 0.040 in (1 mm) between leading and lagging cylinders
- For use with standard single- or double-acting cylinders
- Built in warning and stop alarms for optimum safety
- Available with several flow options for optimal lifting speed

▼ Shown: 3600-ton tunnel boring machine lowered and tilted into its starting position with the EVO-Series Synchronous Lifting System.



The Multi-Functional Synchronous Lifting System



Ease of Operation

- A single operator controls the entire operation
- User friendly interface: visual screens, icons, symbols and color coding



Lifting Cylinders

For a complete line of Enerpac cylinders, see the cylinder and lifting products in our catalog.

Page: 5



Hoses

Enerpac offers a complete line of high-quality hydraulic hoses. To ensure the integrity of your system, specify only genuine Enerpac hydraulic hoses.

Page: 132



Enerpac's family of EVO Synchronous Lifting Systems provides precision control suitable for most lifting/lowering applications. Custom systems tailored to unique project requirements are also available.

The Standard EVO Synchronous Lift System

It's a comprehensive self-contained design that features simple to use software that is extremely efficient at completing basic to complex applications.

The Basic EVOB Synchronous Lift System

Leveraging Enerpac's market leading Z-Class pumps and components from the standard EVO, the EVOB offers an economical solution to basic applications requiring stroke only control for a maximum of 8 lifting points.

Synchronous Lifting Systems

CUSTOM BUILD YOUR OWN SYNCHRONOUS LIFTING SYSTEM

▼ This is how a SyncLift model number is built up.

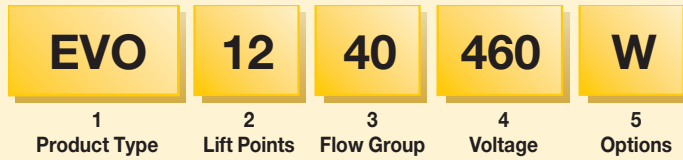

1 Product Type

EVO = Standard SyncLift System
EVOB = Basic SyncLift System

2 Lift Points

4 = 4 Lift Points
8 = 8 Lift Points
12 = 12 Lift Points (EVO only)

3 Flow Group (in³/min) 60Hz

EVO
21 = 153
40 = 293

EVOB
05 = 40
08 = 60
16 = 120*

*only available with 3 Ph motor

4 Voltage ¹⁾

EVO
380 = 380-415 V, 3 Ph, 50-60 Hz
460 = 460-480 V, 3 Ph, 50-60 Hz

EVOB
B = 115 V, 1 Ph, 50-60 Hz
E = 208-240 V, 1 Ph, 50-60 Hz
G = 208-240 V, 3 Ph, 50-60 Hz
W = 380-415 V, 3 Ph, 50-60 Hz
J = 460-480 V, 3 Ph, 50-60 Hz
R = 575 V, 3 Ph, 60 Hz

5 Options

W = Weighing
 (Only available with the EVO Standard SyncLift System)

Weighing option includes load cell inputs with special programming for calibration and center of gravity.

¹⁾ 115 VAC supply voltage required for pumps with G, J, R suffixes.
 230 VAC supply voltage required for pumps with W suffix.

Ordering Examples:

Model Number: EVO821460W

EVO has 8 lift points, 153 in³/min, and voltage is 460-480 V, 3-Phase, 50-60 Hz with weighing option.

Model Number: EVOB408B

EVOB has 4 lift points, 60 in³/min, and voltage is 115 V, 1-Phase, 50-60 Hz.

EVO Series



Reservoir Capacity:

10 or 66 gallons

Number of Lifting Points:

4, 8 or 12

Accuracy:

0.040 inch

Motor Size:

1-10 hp

Maximum Operating Pressure:

10,000 psi



Contact Enerpac!

Contact the Enerpac office nearest to you for advice and technical assistance in the layout of your ideal solution or visit us on the web:
enerpac.com/contact-us.

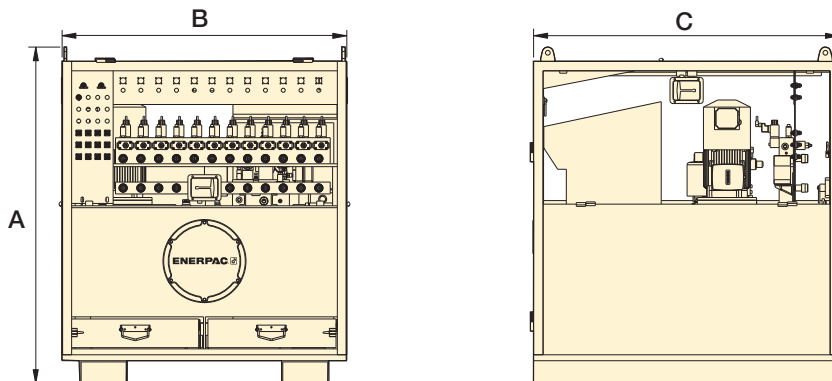

Series	Reservoir Capacity	A	B	C	Motor Size	Weight
	(gal)	(in)	(in)	(in)	(hp)	(lbs)
EVO	66	63.37	54.07	55.00	5-10	3000
EVOB	10	48.57	34.00	32.43	1-3	610

▼ Synchronous lift system used to lift a 1000-ton building.



Enerpac offers a wide variety of hydraulic pumps for all your custom needs.

Hydraulic pumps are at the heart of any hydraulic system. Different systems require different flow, pressure and control. Enerpac offers a wide variety of hydraulic pumps from small hand-operated pumps to large gasoline powered pumps. Still many applications require a customized pump to operate

the system. These may include larger reservoir capacity, custom valve configurations or added electrical controls.

Enerpac also specializes in power units and controls used for synchronous lifting/lowering of multiple jacking points.



◀ *Private labeled electric torque wrench pumps for OEMs.*



◀ *Custom pumps with control packages.*



◀ *Pumps with custom valve manifolds and circuits.*

OVERVIEW



▲ *Custom hydraulic pump for a bridge deck launching system.*

CUSTOMIZABLE FEATURES:





- Reservoir and Frame
- Valve Configurations
- Controls
- Oil Types
- Seals
- Pressure and Flow
- Coolers and Heaters
- Paint
- Motor Type
- Human Machine Interface (HMI)

Directional Control Valves Section Overview

Energac hydraulic valves are available in a wide variety of models and configurations.

Whatever your requirements... directional control, flow control, or pressure control... you can be sure that Energac has the correct valve to match your application exactly.

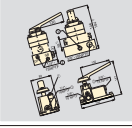
Designed and manufactured for safe operation up to 10,000 psi, the range of Energac valves allows for direct pump mounting, remote mounting, manual or solenoid actuation, and in-line installation, giving you flexible solutions to control your hydraulic system.

Valve Type	Series		Page
Pump-Mounted Directional Control Valves	VM, VE		124 ▶
Remote-Manual Directional Control Valves	VC		126 ▶
Valve Dimensions	VC, VM, VE		127 ▶
Modular/Solenoid Operated Directional Control Valves	VE		128 ▶



Pressure and Flow Control Valves

For more hydraulic system control with pressure relief valves, shut-off valves, check valves and sequence valves see our "System Components" section.

Page: 130



Valving Help

See Basic System Set-Up and Valve Information in our 'Yellow Pages'

Page: 278



▼ Shown from left to right: VM32, VE33, VM33, VM43L, VE43-115



For Reliable Control of Single and Double-Acting Cylinders

Valve Operation	Used with Cylinder	Valve Type	
Manual	Single-acting	3-Way 2 Position	
Manual	Single-acting	3-Way 2 Position	
Manual	Single-acting	3-Way 3 Position, Tandem Center	
Manual	Single-acting ONLY	3-Way 3 Position, Tandem Center, Venturi Return Assist	
Manual	Double-acting	4-Way 3 Position, Tandem Center	
Manual	Single-acting	3-Way 3 Position, Tandem Center, Locking	
Manual	Double-acting	4-Way 3 Position, Tandem Center, Locking	
Solenoid 24 VDC	Single-acting	3-Way 2 Position	
Solenoid 24 VDC	Single-acting	3-Way 2 Position, Dump	
Solenoid 24 VDC	Single-acting ONLY	3-Way 3 Position, Tandem Center, Venturi Return Assist	
Solenoid 24 VDC	Single-acting	3-Way, 3 Position, Tandem Center	
Solenoid 115 VAC	Single-acting	3-Way, 3 Position, Tandem Center	
Solenoid 24 VDC	Double-acting	4-Way, 3 Position, Tandem Center	
Solenoid 115 VAC	Double-acting	4-Way, 3 Position, Tandem Center	

- Advance/Retract and Advance/Hold/Retract operation of single-acting and double-acting cylinders
- Manual or solenoid operation
- Pump mounting will retrofit on most Enerpac pumps
- Available “locking” option on VM Series valves for load-holding applications
- Standard “locking” feature on VE Series 3-position valves
- User adjustable relief valves allow the operator to easily set the working pressure

▼ ZE4420SB-FH Z-Class pump is mounted next to an Enerpac H-frame press, includes VE43 electric valve to control cylinder operation.

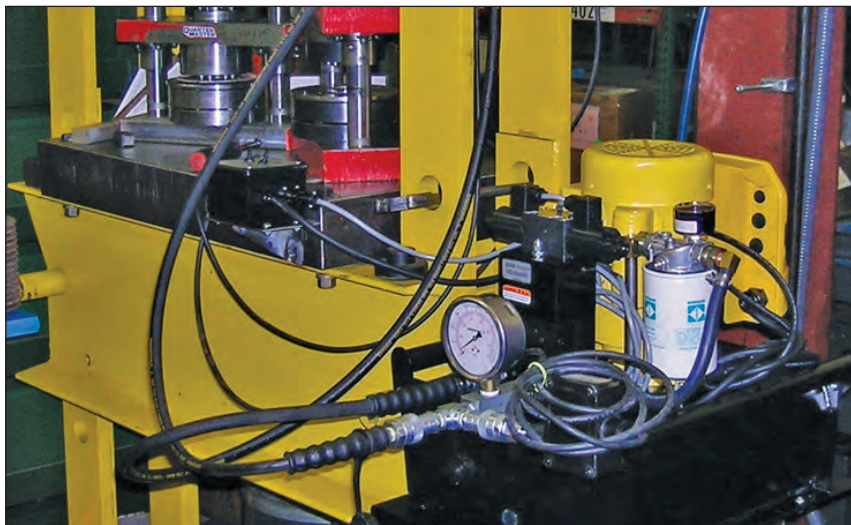

For remote valve applications, see page 126.

Pump Mounted Directional Control Valves



All valves feature several gauge ports for “system”, A port and B port pressure monitoring. User-adjustable relief valves are included on all models to allow the operator to easily set the optimum working pressure for each application. VM33 and VE43 valves include “System Check” feature, for more precise pressure holding and improved system control. The VM33 has improved porting which provides faster cylinder retraction while motor is running.

VM, VE Series



Flow Capacity:

4.5 gal/min.

Maximum Operating Pressure:

10,000 psi

Model Number	Hydraulic Symbol	Schematic Flowpath			Weight (lbs)
		Advance	Neutral	Retract	
VM22					5.6
VM32					5.6
VM33					6.7
VM33VAC					7.5
VM43					6.8
VM33L					10.7
VM43L					10.8
VE32					8.7
VE32D					8.7
VE33VAC					22
VE33					20.3
VE33-115					20.3
VE43					20.3
VE43-115					20.3



Assisted Return Pumps

To improve productivity and plunger retraction, Enerpac offers valve configurations designed to accelerate your cylinder retraction speeds. ZU4 and ZE-Series pumps feature Venturi valve technology to facilitate the faster return of single-acting gravity return cylinders. See details on www.enerpac.com



Locking Valves

For applications that require positive load holding, VM Series valves (except the VM22 and VM32 valve) are available with a pilot-operated check valve. This option provides hydraulic locking of the load until the valve is shifted into the retract position.

To order this feature, place an “L” at the end of the model number.



Pendants for VE-Series Solenoid Valves

When ordering Enerpac VE-Series solenoid valves, the pendant must be ordered separately for Z-Class pumps. Pendant connection to be plugged into electric box of pump.

To be used with solenoid valves:	Pendant
VE32D	ZCP-1
VE32, VE33, VE43	ZCP-3

See page 127 for product dimensions.

▼ Shown from left to right: VC-20, VC-4L



Reliable Remote Control



Locking Valves

For applications that require positive load holding, VC and VM Series valves are available with a pilot-operated check valve. This option provides hydraulic locking of the load until the valve is shifted into the retract position.

- Advance/Hold/Retract operation for use with single-acting or double-acting cylinders

Valve Operation	Used with Cylinder	Valve Type	Model Number	Hydraulic Symbol	Schematic Flowpath			Weight (lbs)
					Advance	Hold	Retract	
Manual	Single Acting	3-Way, 3 Position, Tandem Center	VC-3					6.4
Manual	Single Acting	3-Way, 3 Position, Tandem Center, Locking	VC-3L					10.3
Manual	Single Acting	3-Way, 3 Position, Closed Center	VC-15					6.4
Manual	Single Acting	3-Way, 3 Position, Closed Center, Locking	VC-15L					10.3
Manual	Double Acting	4-Way, 3 Position, Tandem Center	VC-4					6.4
Manual	Double Acting	4-Way, 3 Position, Tandem Center, Locking	VC-4L					10.3
Manual	Double Acting	4-Way, 3 Position, Closed Center	VC-20					6.4
Manual	Double Acting	4-Way, 3 Position, Closed Center, Locking	VC-20L					10.3

Return line kit included with remote valves

▼ Shown top to bottom: VEC-15600D, VEK-15000B, VEC-15000B



- Ideal for independent control of multiple cylinders or functions
- Relief valve and pilot-operated check accessory valves are stackable between manifold and valve body
- Remote and pump mounting

Valve Flow Path	Used with Cylinder	Valve Code	Hydraulic Symbol
4-Way, 3-Position (4/3) Open Center	Double-acting	A	
4-Way, 3-Position (4/3) Closed Center	Double-acting	B	
4-Way, 3-Position (4/3) Tandem Center	Double-acting	C	
4-Way, 3-Position (4/3) Float Center	Double-acting	D	
4-Way, 2-Position (4/2) Crossover Offset	Double-acting	E	
3-Way, 3-Position (3/3) Tandem Center	Single-acting	F	
3-Way, 3-Position (3/3) Closed Center	Single-acting	G	
2-Way, 2-Position (2/2) Normally Closed	System	H*	
2-Way, 2-Position (2/2) Normally Open	Un-loading	K*	
4-Way, 2-Position (4/2) Float Offset	Double-acting	M	
3-Way, 2-Position (3/2) Normally Open	Single-acting	P	

* Requires use of tank port for dump or unloading.

Unmatched Combinations and Possibilities



3-Way Check Valve

Use a **VS-51** 3-way pilot operated check valve assembly to convert your 3-way modular valve into a load-holding valve.



4-Way Check Valve

Use a **VS-61** 4-way pilot operated check valve assembly to convert your 4-way modular valve into a load-holding valve.



System Pressure Control

To add system pressure control to your modular valve, order **VS-11 Relief Valve** assembly.



Bolt Kits for Accessory Valves With No Manifold

Order Bolt Kit **BK-2** when adding one of the accessory valves. Order Bolt Kit **BK-3** when adding any combination of two accessory valves.

How to order one of the 1,300 possible model numbers?

With over 1,300 possible model numbers, Enerpac has the perfect valve for you. Use the "chart" to build your own valve for the specific application you require. This is the complete guide to all the Modular valves that are available.

Solenoid Operated Modular Valves

CUSTOM BUILD YOUR MODULAR VALVES

▼ This is how a Modular Valve Model Number is built up:



1	2	3	4	5	6
Solenoid Operated Valve	Valve Flow Path	Flow Capacity	Voltage	Accessory Valves	Manifold

1 Product Type

VE = Solenoid Operated Valve

2 Valve Code

- A** = 4/3 Open Center
- B** = 4/3 Closed Center
- C** = 4/3 Tandem Center
- D** = 4/3 Float Center
- E** = 4/2 Crossover Offset
- F** = 3/3 Tandem Center
- G** = 3/3 Closed Center
- H** = 2/2 Normally Closed
- K** = 2/2 Normally Open
- M** = 4/2 Float Offset
- P** = 3/2 Normally Open

3 Flow Capacity

1 = 4 gallons per minute

4 Voltage

- 1** = 24 VDC
- 2** = 220/240 V, 1 ph, 50 Hz
- 5** = 115 V, 1 ph, 60 Hz
- 6** = 230 V, 1 ph, 60 Hz

5 Accessory Valves

- 000** = No accessory valves
- 100** = Relief Valve only
- 150** = Relief Valve and 3-way pilot operated check valve
Only for VEF/VEG
- 160** = Relief Valve and 4-way pilot operated check valve
Only for VEA/VEB/VEC/VED
- 500** = 3-way pilot operated check valve
Only for VEF/VEG
- 600** = 4-way pilot operated check valve
Only for VEA/VEB/VEC/VED

6 Manifold

- A** = No manifold**
- B** = Remote Mounted
- D** = Pump Mounted*

* Only for valve code: **VEA/VEC/VEF**

** Must order Bolt Kit separately.

Example: VEA-15600-D

VEA-15600-D is a Modular Valve with a 4-way, 3-position open center flowpath, 115 VAC, and an integral pilot-operated check valve, for mounting on an Enerpac pump.

VE Series



Flow Capacity:

4 gal/min.

Maximum Operating Pressure:

10,000 psi

Pressure Drop versus Oil Flow

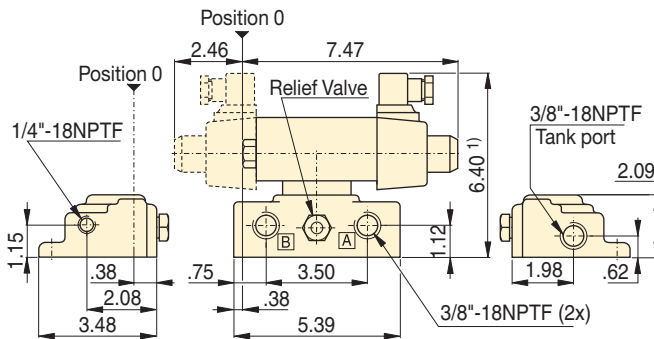
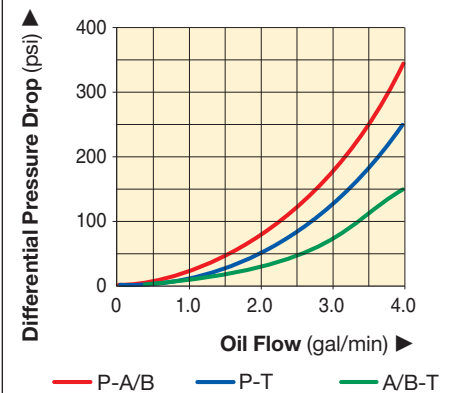

Modular Valve Pump Mounted ¹⁾ add 1.85 inch for each Accessory Valve

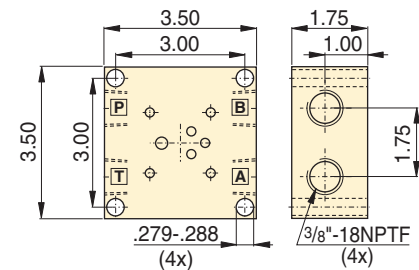

Modular Valve Remote Mount Manifold

Maximum Operating Pressure (psi)	Amperage Draw			Seal Material	Valve Plug
	24 VDC	115 VAC 60 Hz	230 V 60 Hz		
0 - 10,000	N/A Inrush	3.6 A Inrush	1.8 A Inrush	Buna-N, Polyurethane	DIN 43650
	2.5 A Holding	1.0 A Holding	.5 A Holding		

Enerpac System Components —

All the additional components you need to complete your high pressure hydraulic system. Engineered to work with your Enerpac cylinders, pumps and tools. All Enerpac components are designed and manufactured to the most exacting standards.

With this complete line of hydraulic hoses, couplers, fittings, manifolds, oil and gauges Enerpac has the accessories to compliment your system and ensure the efficient operation, long life, and safety of your hydraulic equipment.



Yellow Pages

For sample system set-ups and how to correctly specify your system components, please view the Enerpac **Yellow Pages**.

Page: 273











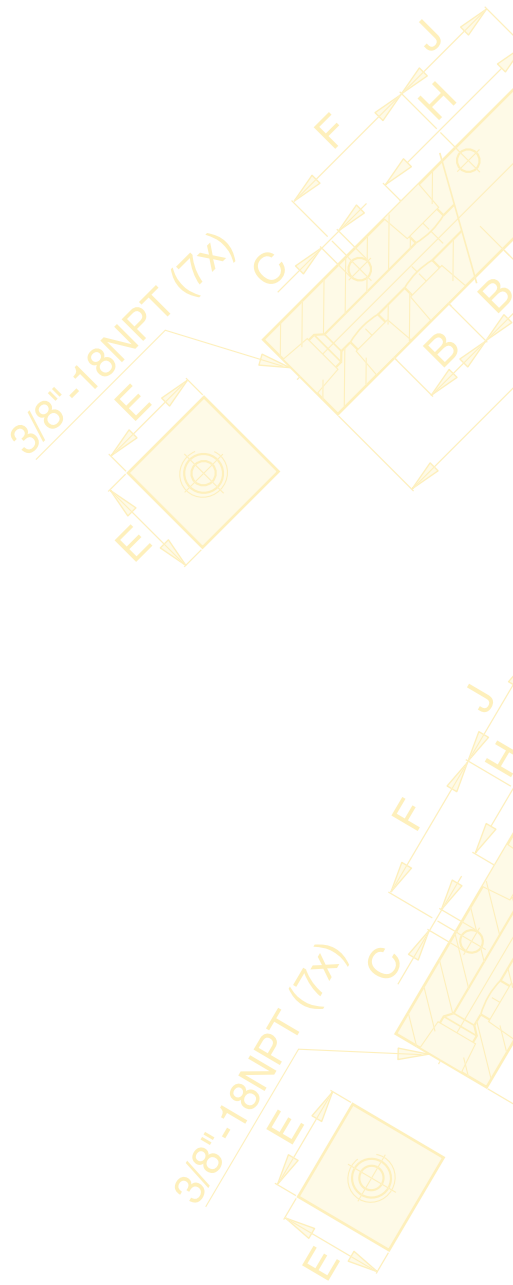





Maintain System Integrity

Use Enerpac System Components, designed to interface with Enerpac Cylinders, Pumps and Tools to ensure your system operates at peak performance.



System Components and Control Valves Section Overview



Component Type	Series		Page
Hoses	H700 H900		132 ▶
Couplers	A, C, F, Z		134 ▶
Hydraulic Oil	HF LX		136 ▶
Manifolds	A		136 ▶
Control Manifolds	AM		136 ▶
Fittings	FZ		137 ▶
Hydraulic Force & Pressure Gauges	GF GP		138 ▶
Hydraulic Pressure Gauges	G, H		140 ▶
Test System Gauges	T		142 ▶
Digital Gauges	DGR		143 ▶
Gauge Adaptor Assembly	GA45		144 ▶
Gauge Accessories	GA NV V		145 ▶
Flow and Pressure Control Valves	V		146 ▶

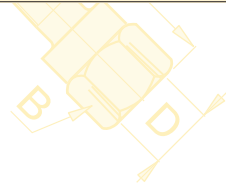

▼ Shown from top to bottom: HC-7206, HC-7210, HC-9206



Emphasize Safety and Quality



To ensure the integrity of your system, specify only Enerpac hydraulic hoses.

WARNING !

- Do not exceed 10,000 psi maximum pressure.
- Do not handle hoses while under pressure.

More safety instructions in our “Yellow Pages”.

Page: 274

Crimped-on rubber strain relief for improved life and durability on all models.

Thermo-plastic Hoses (700-Series)

- For demanding applications, featuring a 4:1 design factor
- Maximum working pressure of 10,000 psi
- Two layers of steel wire braids
- Outside jacket is polyurethane, to provide maximum abrasion resistance
- Exhibits low volumetric expansion under pressure to enhance overall system efficiency

Heavy-duty Rubber Hoses (900-Series)

- The most complete offering: 35 models up to 50 feet in length
- Rubber coated with two layers of steel wire braids
- Designed to comply with Material Handling Institute IJ-100 hose specification
- Flexible, with little “memory”, is the best choice for long hose runs



◀ To prevent back pressure and to increase cylinder retraction speed, when using long hoses, the Enerpac HC-7300 range of hoses with increased internal diameter is the best choice.

▼ Hose End Couplings

1/4" NPTF	
3/8" NPTF	
A-604	
A-630	
AH-604	
AH-630	
C-604	
CH-604	

High Pressure Hydraulic Hoses



Hose Oil Capacity

When using long hose lengths, it is sometimes necessary to fill the pump reservoir after filling the hoses. To determine the hose oil capacity, use the following:

For .25" internal diameter hoses: Capacity (in³) = .5892 x Length (ft)

For .38" internal diameter hoses: Capacity (in³) = 1.3608 x Length (ft)

H700 H900 Series



Inside Diameter:

.25 and .38 inch

Length:

2-50 feet

Maximum Operating Pressure:

10,000 psi

Internal Dia. (in)	Hose End Assemblies and Couplers*		Hose Length (ft)	700-Series Thermo-plastic		900-Series Heavy-duty Rubber			
	End one	End two		Model Number	Wt. (lbs)	Model Number	Wt. (lbs)		
.25	1/4" NPTF	1/4" NPTF	6	-		H-9206Q	2.6		
		3/8" NPTF	6	-		H-9206S	2.6		
		A-630	6	HB-7206QB	2.4	HB-9206QB	3.1		
		AH-630	6	-		HB-9206Q	2.9		
		CH-604	6	HC-7206Q	2.3	HC-9206Q	3.0		
	3/8" NPTF			2	H-7202	1.2	H-9202	1.6	
				3	H-7203	1.5	H-9203	1.9	
				6	H-7206	2.0	H-9206	2.6	
				10	H-7210	3.0	H-9210	3.9	
				20	H-7220	6.2	H-9220	8.0	
				30	H-7230	10.0	H-9230	13.0	
				50	H-7250	15.4	H-9250	22.0	
		A-604		-		-		-	
			6	HA-7206B	2.5	HA-9206B	3.2		
			10	-		HA-9210B	4.5		
				-		-			
			AH-604		3	-		HA-9203	2.1
					6	HA-7206	2.2	HA-9206	2.9
		10		HA-7210	3.2	HA-9210	4.2		
	AH-630		6	HB-7206	2.2	HB-9206	2.9		
			3	HC-7203B	2.2	HC-9203B	2.9		
	C-604		6	HC-7206B	2.8	HC-9206B	3.7		
			10	HC-7210B	3.9	HC-9210B	5.0		
			3	HC-7203	1.7	HC-9203	2.2		
	CH-604		6	HC-7206	2.3	HC-9206	3.0		
			10	HC-7210	3.3	HC-9210	4.3		
			20	HC-7220	6.4	HC-9220	8.3		
			6	HC-7206C	2.4	HC-9206C	3.1		
CH-604	CH-604	6	HC-7206C	2.4	HC-9206C	3.1			
		50	HC-7250C	15.4	HC-9250C	20.0			
.38	3/8" NPTF		6	H-7306	3.5	H-9306	4.6		
			10	H-7310	5.4	H-9310	7.0		
			20	H-7320	10.0	H-9320	13.0		
			30	H-7330	16.2	H-9330	21.0		
			50	H-7350	15.2	H-9350	33.0		
	CH-604		6	HC-7306	3.4	HC-9306	4.9		
			8	-		HC-9308	6.2		
			10	HC-7310	5.6	HC-9310	7.3		

* For technical information on couplers see next page.



GA45GC Gauge Adaptor

Protect yourself from system overloading by simply ordering one part number for a pre-assembled gauge, adaptor block and coupler.

Page: 144



Torque Wrenches Hoses

Use Enerpac 3.5:1 twin safety hoses with double-acting wrenches to ensure the integrity of your hydraulic system. See Selection Matrix.

Page: 238



Fittings

For additional fittings see the fitting page of the System Components section.

Page: 136

▼ Shown: FH-604, FR-400, A-630 disassembled, C-604, AH-604, AR-400



3/8" High Flow Couplers

- Standard equipment on most Enerpac cylinders
- Recommended for use on all Enerpac pumps and cylinders where space and porting permits
- Include "2-in-1" dust cap for use on male and female coupler halves

3/8" High Flow "Flush-face" Couplers

- Featuring "Push-to-connect" operation, to guarantee good connection every time
- Flush-face, zero-leak operation for minimal spillage
- HTMA* recognized for safety and performance

3/8" Regular Spee-D-Coupler®

- For medium-duty applications; for use with hand pumps
- Includes female steel dust cap

1/4" Regular Coupler

- For use with small cylinders and hand pumps
- Includes female steel dust cap

1/4" Spin-on Torque Wrench Couplers

- For use with 10,000 psi S- and W-Series torque wrenches, THQ-Series hoses and 10,000 psi torque wrench pumps

* Hydraulic Tool Manufacturers Association

Quick Connection of Hydraulic Lines



Thread Sealer

To seal NPTF threads use one of the new anaerobic thread sealers or Teflon® paste. When using Teflon® tape, apply the tape one thread back from the end of a fitting to prevent it from entering the hydraulic system.



WARNING!

Couplers should be pressurized only when completely connected, and should not be coupled or uncoupled when pressurized.

More safety instructions in our "Yellow Pages".

Page: 274



S- and W-Series Torque Wrench Couplers

S- and W-Series Torque Wrenches require 1/4" spin-on couplers and THQ hoses.

Page: 206

▼ With the use of Enerpac High Flow Couplers, hoses are easily installed for multiple hydraulic line connections in this 34 points PLC-controlled lifting system.



Hydraulic Couplers



F-Series

Flush-faced couplers provide reduced pressure drop versus other types and are preferred in dirty, grimy construction and mining environments due to easy clean, non-dirt trapping faces.



Metal Dust Caps

Steel dust caps are available for the C-604 series couplers. Order model number: **CD-411M** for female half **CD-415M** for male half

A, C, F, T Series



Maximum Flow Capacity:
2,500 in³/min.

Thread:
1/4" and 3/8" NPTF

Maximum Operating Pressure:
10,000 psi



CT-604 Safety Tool

Use the Enerpac CT-604 to relieve hydraulic back pressure by safely bleeding the hydraulic coupler.

Minimize injuries from projectile parts and under-skin hydraulic fluid injections by eliminating unsafe coupler bleeding practices. The CT-604 is Enerpac-engineered safe for use at 10,000 psi (700 bar).

NOTE: C-Series only.

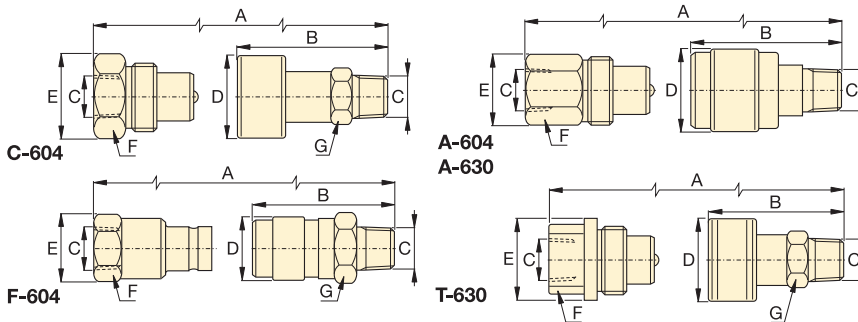

Maximum Flow Capacity (in ³ /min)	Coupler Type	Model Numbers			Dimensions (in)							Dust Cap(s)
		Complete Set	Female Half	Male Half	A*	B	C	D	E	F	G	
2,500	High Flow Coupler	C-604	CR-400	CH-604	3.26	2.87	3/8" NPTF	1.38	1.38	1.25	1.00	(2x) CD-411 Included
2,500	Flush-face coupler	F-604	FR-400	FH-604	4.36	2.85	3/8" NPTF	1.23	1.23	1.06	1.12	-
462	Regular Spee-D-Coupler®	A-604	AR-400	AH-604	3.09	2.53	3/8" NPTF	1.12	.94	.94	.73	Z-410 female only Included
462	Regular Coupler	A-630	AR-630	AH-630	2.61	1.72	1/4" NPTF	.87	.81	.75	.57	Z-640 female only Included
695	Spin-on Coupler	T-630	TR-630	TH-630	2.87	2.36	1/4" NPTF	1.14	1.14	.74	.82	-

* Value A is total length when male and female halves are connected.

▼ Shown top to bottom: HF-101, HF-100, HF-102, LX-101, A65, and FZ1055



Enerpac System Components

Hydraulic Oil		High viscosity index ensures maximum lubricity over a wide range of operation temperatures.
Contents	Model Number	
1 Quart	HF-100	
1 Gallon	HF-101	
5 Gallons*	HF-102	
55 Gallons	HF-104	
1 Gallon**	LX-101	

* Packed in two 2½ gallon cans.

** Hand pump oil.

HF Oil

- Specially formulated for power pumps
 - maximum volumetric efficiency
 - maximum heat transfer
 - prevents cavitation
 - anti-sludge, anti-rust, anti-foam additives
- Maximum film protective lubricity
 - anti-oxidation additives

LX Hand Pump Oil

- Specially formulated for hand pumps
 - anti-sludge, anti-rust additives
- Reduced handle effort over HF blue oil
 - good low temperature performance
- Not for use in power pumps

▼ Oil Specifications Chart

	HF Oil	LX Oil
ISO Viscosity Grade	32	15
API Gravity, ASTM D1298	32	34
Viscosity, ASTM D445		
SUS @ 212°F	43.7	38
SUS @ 104°F	151	77.5
Viscosity Index, ASTM D2270	95	100
Pour Point, °F, ASTM D97	-36.5	-47.5
Flash Point, °F, ASTM D92	375	370
Color	Blue	Yellow

NOTE: SAE grades do not apply to hydraulic oil.

Manifolds

Description		Model No.	Dimensions (in)
7" Long Manifold with 7 female ports.		A-64	
14" Long Manifold that allows direct mounting of control valves to the manifold. 7 female ports.		A-65	
6-Port Hexagon Manifold Plugs furnished for all ports 3/8"-18 NPTF.		A-66	
Premounted Manifold Functions as split-flow valve to control 2 to 4 single-acting cylinders simultaneously. All ports 3/8"-18 NPTF.		AM-21 AM-41	

Hydraulic Oil, Manifolds and Fittings



3/8" Swivel Connector

360° swivel coupler for optimal orientation of the hydraulic connection on cylinders, pumps and hoses. Order Model No. XSC-1.

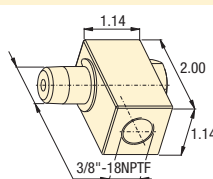

**A, AM
FZ,
BFZ,
HF, LX
Series**



10,000 psi Fittings		Model Number	Dimensions (in)				Diagram	
			A	B	C	D		
Street Elbow			FZ-1616	.94	1.30	3/8" -18 NPTF	3/8" -18 NPTF	
From: 3/8" -NPTF Male	To: 3/8" -NPTF Female							
Reducing Connector			FZ-1615	1.13	1.00	3/8" -18 NPTF	1/4" -18 NPTF	
From: 3/8" -NPTF Female	To: 1/4" -NPTF Female							
			FZ-1625	1.38	1.25	1/2" -14 NPTF	3/8" -18 NPTF	
From: 1/2" -NPTF Female	To: 3/8" -NPTF Female							
Hexagon Nipple			FZ-1608	1.50	.63	1/4" -18 NPTF	1/4" -18 NPTF	
From: 1/4" -NPTF	To: 1/4" -NPTF							
From: 3/8" -NPTF	To: 3/8" -NPTF							
From: 3/8" -NPTF	To: 3/8" -NPTF							
Coupling			FZ-1614	1.14	1.00	3/8" -18 NPTF	3/8" -18 NPTF	
From: 3/8" -NPTF	To: 3/8" -NPTF							
			FZ-1605	1.14	.75	1/4" -18 NPTF	1/4" -18 NPTF	
From: 1/4" -NPTF	To: 1/4" -NPTF							
Cross			FZ-1613	1.77	1.00	3/8" -18 NPTF	-	
From: 3/8" -NPTF Female	To: 3/8" -NPTF Female							
Street Tee			FZ-1612	1.77	1.00	3/8" -18 NPTF	-	
From: 3/8" -NPTF	To: 3/8" -NPTF							
			FZ-1637	1.77	.94	1/4" -18 NPTF	-	
From: 1/4" -NPTF	To: 1/4" -NPTF							
Street Tee			BFZ-16312	2.20	1.02	3/8" -18 NPTF	3/8" -18 NPTF	
From: 3/8" -NPTF Female	To: 3/8" -NPTF Male							
Elbow			FZ-1610	1.38	.88	3/8" -18 NPTF	-	
From: 3/8" -NPTF	To: 3/8" -NPTF							
			FZ-1638	1.41	.94	1/4" -18 NPTF	-	
From: 1/4" -NPTF	To: 1/4" -NPTF							
Reducer			FZ-1630	.75	.75	1/4" -18 NPTF	3/8" -18 NPTF	
From: 3/8" -NPTF	To: 1/4" -NPTF							
From: 1/4" -NPTF	To: 1/2" -NPTF							
			BFZ-1630	1.10	.86	1/4" -18 NPTF	1/2" -14 NPTF	
From: 3/8" -NPTF	To: G1/4"							
Adaptor			BFZ-16411	1.37	.75	1/4" -18 NPTF	G1/4"	
From: G1/4"	To: 1/4" -NPTF							
From: G1/4"	To: 1/8" -NPTF							
From: G3/8"	To: 1/4" -NPTF							
			BFZ-16323	1.69	.94	1/4" -18 NPTF	G3/8"	
From: G3/8"	To: 3/8" -NPTF							
From: G3/8"	To: 3/8" -NPTF							
Adaptor			FZ-1055	1.75	.94	1/4" -18 NPTF	3/8" -18 NPTF	
From: 1/4" -18 NPTF	To: 3/8" -18 NPTF							
From: 1/2" -14 NPTF	To: 1/4" -18 NPTF							
			FZ-1633	1.18	.75	1/2" -27 NPTF	1/4" -18 NPTF	
From: 1/2" -14 NPTF	To: 3/8" -18 NPTF							
			FZ-1634	1.75	1.13	3/8" -18 NPTF	1/2" -18 NPTF	
From: 1/2" -14 NPTF	To: 3/8" -18 NPTF							
Swivel Fitting			FZ-1660	1.59	.88	3/8" -18 NPTF	3/8" -18 NPTF	
From: 3/8" -NPTF Male	To: 3/8" -NPTF Female							

▼ Shown: GF-230P, GF-835P, GP-10S



- GF-Series gauges are calibrated with dual scale reading for pressure and force
- Excellent readability; 4 inch diameter gauge face
- Fast, easy installation
- GF-Series gauges are glycerin filled
- Stainless steel gauge cases for corrosion resistance
- GP-Series gauges are calibrated with dual scale reading for psi and bar

▼ A GP-10S gauge is used on this press to check the hydraulic pressure required to bend a steel plate.



Visual References for System Pressure and Force



Auto-Damper Valve V-10

For automatic control of gauge fluctuations, the V-10 Auto-Damper Valve controls the movement of the gauge needle by restricting oil flow in and out of the gauge. No adjustments needed.



Page: 147



Snubber Valve V-91

Infinitely adjustable for metering oil out of a gauge. The V-91 Snubber Valve is also suitable as a shut-off valve to protect the gauge during high cycle applications.

Page: 147

Used With	
	All Cylinders
	All Cylinders
	All 5 ton RC Cylinders
	All 10 ton RC Cylinders
	All 25 ton RC Cylinders
	RC and RR 50 ton Cylinders
	12 ton RCH-Series
	RCH/RRH-20, 30 and 60 ton
	RCS-201, 302
	RCS-502, 1002
	25 ton Presses
	50 ton Presses
	25-50 ton Presses
	100 ton Presses
	150-200 ton Presses

Hydraulic Force and Pressure Gauges



Load Gauges

To measure external load supported by a cylinder or jack. For pressing parts together under pre-determined loads, weighing, testing, etc.

Pressure Gauges

To measure the input pressure into cylinders, jacks or high pressure systems. Also for all testing applications.

GP-Series gauges are dry gauges.

GF-Series gauges are glycerin filled.

GF GP Series



Pressure Range:

0-15,000 psi

Face Diameter:

4 inch

Accuracy, % of full scale:

± 1%

All Models

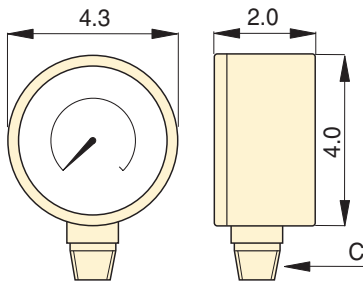

Maximum Indicator Pointer

Indicator retains peak readings of pressure or force generated by the system.

Order model number:

H-4000G.

Can easily be installed on GP-Series dry gauges.

Gauge Type and Calibration					Units per Division	Model Number*	Thread C (in)	Gauge Adaptor		
psi	bar	psi	lbs	tons				GA-1	GA-2	GA-3
0-10,000	0-700	-	-	-	100 psi, 10 bar	GP-10S	1/2 NPTF	●	●	
0-15,000	0-1000	-	-	-	200 psi, 10 bar	GP-15S	1/2 NPTF	●	●	
-	-	0-10,000	0-10,000	0-5	100 psi, 100 lbs, .1 ton	GF-5P	1/2 NPTF	●	●	
-	-	0-10,000	0-22,200	0-11	100 psi, 200 lbs, .2 ton	GF-10P	1/2 NPTF	●	●	
-	-	0-10,000	0-51,500	0-25.5	100 psi, 500 lbs, .5 ton	GF-20P	1/2 NPTF	●	●	
-	-	0-10,000	0-110,000	0-55	100 psi, 1000 lbs, 1 ton	GF-50P	1/2 NPTF	●	●	
-	-	0-10,000	0-27,000	0-13.5	100 psi, 200 lbs, .25 ton	GF-120P	1/2 NPTF	●	●	
-	-	0-10,000	-	0-23.5/36/65	100 psi, .5/5/1 ton	GF-813P	1/4 NPTF			●
-	-	0-10,000	-	0-22/32	100 psi, .5/5 ton	GF-230P	1/2 NPTF	●	●	
-	-	0-10,000	-	0-50/100	100 psi, 1/1 ton	GF-510P	1/2 NPTF	●	●	
-	-	0-10,000	0-51,500	0-25.5	100 psi, 500 lbs, .5 ton	GF-20P	1/2 NPTF	●	●	
-	-	0-10,000	0-11,000	0-55	100 psi, 1000 lbs, 1 ton	GF-50P	1/2 NPTF	●	●	
-	-	0-10,000	-	0-25.5/32.5/55	100 psi, .5/5/5 ton	GF-835P	1/4 NPTF			●
-	-	0-10,000	-	0-79/103	100 psi, 1/1 ton	GF-871P	1/4 NPTF			●
-	-	0-10,000	-	0-150/200	100 psi, 5/5 ton	GF-200P	1/4 NPTF			●

* Metric scale Force Gauges are available by changing the "P" suffix to "B".

▼ Shown: H-4049L, G-2534R, G-4089L, G-2535L, G-4040L



Visual References for System Pressure



GA45GC Gauge Adaptor Assembly

45° angled gauge adaptor improves safety.

Page: 144



Gauge Adaptor

For easy gauge installation into almost any system, Enerpac offers a complete line of gauge adaptors.

Page: 145



Snubber Valve

Infinitely adjustable for metering oil out of a gauge. The V-91 Snubber Valve is also suitable as a shut-off valve to protect the gauge during high-cycle applications.

Page: 147

Glycerin Filled (G-Series)

- Calibrated in dual scale reading in psi and bar
- All pressure sensing parts sealed and dampened by glycerin for long life
- Includes safety blow-out disk and pressure equalizing membrane
- Gauge snubbers or needle valves recommended for high-cycle applications

High-Cycle Dry Gauges (H-Series)

- Calibrated in dual scale reading in psi and bar
- Ideal for use in many applications, specifically for high cycle and harsh environments
- Gauge snubbers or needle valves recommended to shut off gauge when not in use

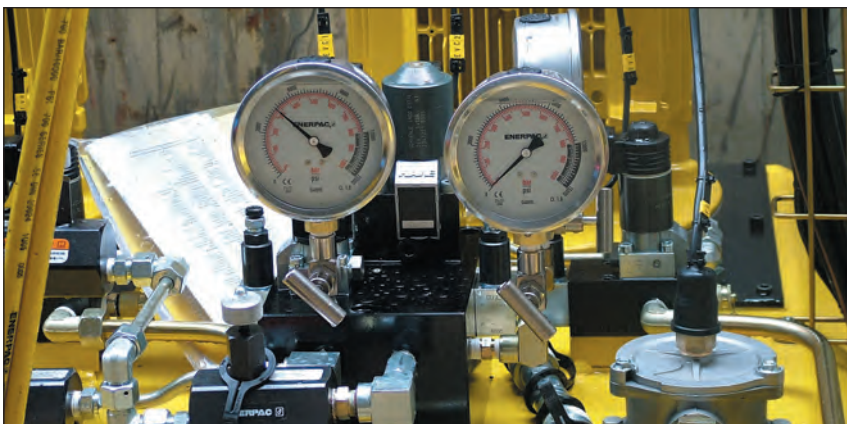

◀ When lifting or pressing, always use a gauge. A gauge is your "window" to the system—it lets you see what's going on.

Hydraulic Pressure Gauges

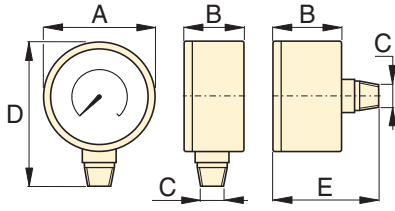

Dimensions (in)						
Face Diam.	Connection	A	B	C	D	E
2.5	Lower Mount	2.50	1.46	¼" NPTF	3.31	–
2.5	Center Rear	2.50	1.46	¼" NPTF	–	2.48
4.0	Lower Mount	4.0	1.15	¼" NPTF	4.80	–
4.0	Lower Mount	4.0	1.93	½" NPTF	5.38	–

Note: dimensions for reference only.

**G
H
Series**



Pressure Range:
0-15,000 psi

Face Diameter:
2.5-4 inches

Accuracy, % of full scale:
±1% and 1½%



Maximum Indicating Pointer

Indicator retains peak readings of pressure or force generated by the system.

Order model number: **H-4000G**.

Note: For use on H-Series gauges only.

▼ SELECTION CHART

Gauge Series	Pressure Range		Model Number				Major Graduation		Minor Graduation		Major Graduation		Minor Graduation	
			Face ø 2.5" ¼ NPTF Lower Mount	Face ø 2.5" ¼ NPTF Center Rear	Face ø 4" ¼ NPTF Lower Mount	Face ø 4" ½ NPTF Lower Mount								
			(psi)	(bar)	Accuracy ±1½%	Accuracy ±1½%	Accuracy ±1%	Accuracy ±1%	(psi)				(bar)	
		(2.5")	(4")	(2.5")	(4")	(2.5")	(4")	(2.5")	(4")	(2.5")	(4")	(2.5")	(4")	
G-Series	0-100	0-7	G2509L	–	–	–	10	–	2	–	1	–	0,01	–
	0-160	0-11	G2510L	–	–	–	10	–	2	–	1	–	0,02	–
	0-200	0-14	G2511L	–	–	–	50	–	5	–	1	–	0,02	–
	0-300	0-20	G2512L	–	–	–	50	–	5	–	5	–	0,50	–
	0-600	0-40	G2513L	–	–	–	100	–	10	–	10	–	1	–
	0-1,000	0-70	G2514L	G2531R	–	–	100	–	20	–	10	–	1	–
	0-2,000	0-140	G2515L	–	–	–	500	–	50	–	10	–	2	–
	0-3,000	0-200	G2516L	–	–	–	500	–	50	–	50	–	5	–
	0-6,000	0-400	G2517L	G2534R	–	–	1000	–	100	–	100	–	10	–
	0-10,000	0-700	G2535L	G2537R	G4088L	G4039L	2000	1000	200	100	100	100	10	10
0-15,000	0-1000	G2536L	G2538R	G4089L	G4040L	3000	3000	200	200	100	100	20	20	
H-Series	0-10,000	0-700	–	–	H4049L	H4071L	–	1000	–	100	–	100	–	10

▼ Gauge shown: T-6003L



T Series

Pressure Range:
0-50,000 psi

Face Diameter:
6.4 inches

Accuracy, % of full scale:
± 1/2% and ± 1 1/2%



Cone Mount Gauge Adaptor

Contains fittings to connect .25" cone fitting gauge to .38" cone system.

Kit includes 43-301 tee, 43-704 gauge adaptor and 45-116 tubing.

Order model number: **83-011**.

Page: 79



Cone Mount Gauge Connector

For connecting gauges with .25" cone fitting directly to model number 11-100 or 11-400 pump. May be used with other .25" cone systems.

Order model number: **43-704**

Page: 79

- Calibrated for dual scale reading in psi and bar
- All gauges have spring-loaded backs with rubber blow-out plugs to protect case assembly in case of over-pressurization
- 40,000 and 50,000 psi models include flange mounting
- 1/2" NPTF versions are made of high-strength alloy steel
- .25" cone models are made of 316 stainless steel, with 403 stainless steel on 40,000 and 50,000 psi models
- Integral maximum indicator pointer standard on all gauges

▼ An Enerpac P-2282 hand pump equipped with a T-6011L test system gauge is used for proof pressure testing of hydraulic valves.

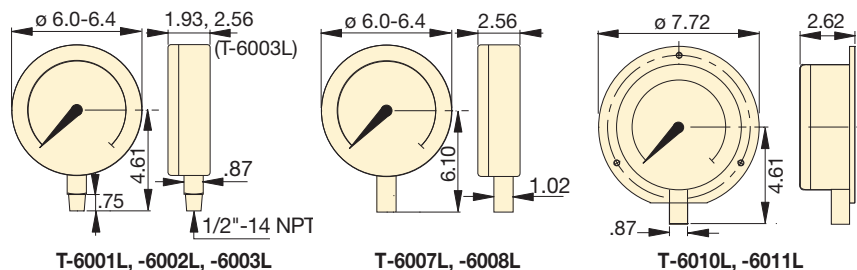

Pressure Range (psi)	Pressure Range (bar)	Model Number		Number Intervals (psi)	Graduation Intervals (psi)	Number Intervals (bar)	Graduation Intervals (bar)
		Alloy Steel 1/2" NPTF	Stainless Steel .25" Cone				
0-1,000*	0-70	T-6001L	-	100	10	10	1
0-5,000*	0-350	T-6002L	-	500	50	50	5
0-10,000*	0-700	T-6003L	T-6007L	1,000	100	100	10
0-20,000*	0-1400	-	T-6008L	1,000	100	200	20
0-40,000**	0-2800	-	T-6010L	5,000	200	500	20
0-50,000**	0-3500	-	T-6011L	5,000	500	500	50

* Accuracy: ± 1/2%

** Accuracy: ± 1 1/2%

Digital, Hydraulic Pressure Gauges

▼ Gauge shown: **DGR-2**



DGR Series

Pressure Range:
0-20,000 psi

Voltage:
3 VDC (battery)

Accuracy, % of full scale:
± 0.25%

- Rated for system pressure up to 20,000 psi
- Displays in multiple units: psi, bar, mPA, kg/cm² (user selectable)
- Zero reset – ensures that gauge reads actual system pressure
- Batteries included, condition indicator on read-out
- IP65 rated case design
- Shut off selectable – menu driven
- UL listed, CE and RoHS compliant



Back-lit Readout

Back-lit readout allows easy reading in less than ideal lighting.



Gauge Adaptor

For easy gauge installation into almost any system, Enerpac offers a complete line of gauge adaptors.

Page: 145

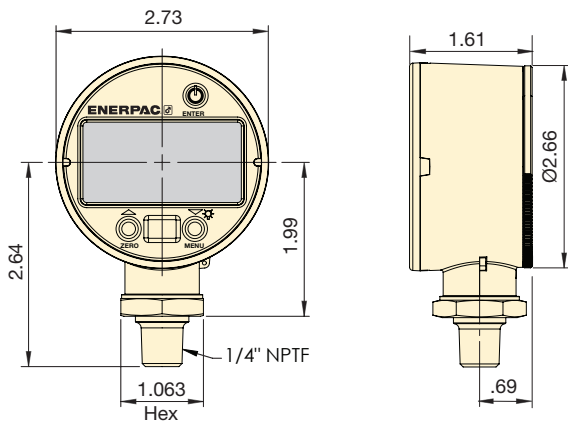

Pressure Rating (psi)		Pressure Rating (bar)		Model Number	Pressure Rating (MPa)		Pressure Rating (Kg/cm ²)	
Range	Resolution	Range	Resolution		Range	Resolution	Range	Resolution
0-20,000	1	0-1380	0.1	DGR-2	0-140	0.01	0-1400	0.1

▼ Greater accuracy and easier to read: enhance your ability to monitor and control hydraulic system pressure up to 20,000 psi.



▼ Shown: A45GC



GA45GC Series

Maximum Operating Pressure:
10,000 psi

Connection 1:
3/8" NPTF male

Connection 2:
CR-400 Coupler

45° Angled gauge adaptor improves safe working conditions

- 45° angled gauge improves visibility
- Slim and narrow design
- Easy to fit in a broad range of systems
- Maximize controlled load movement
- Glycerin dampened gauge with dual scale
- Enerpac high-flow female coupler

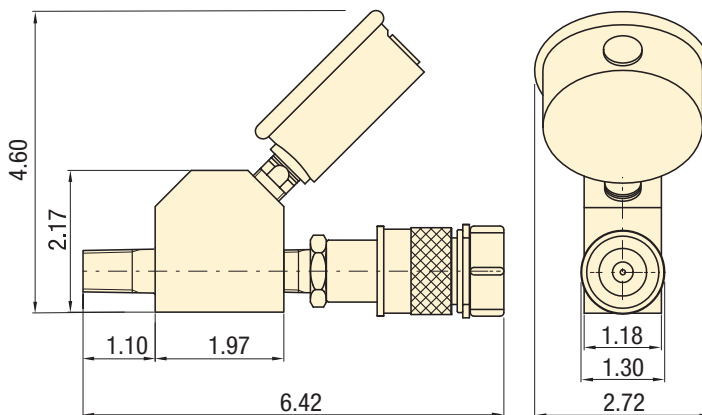

▼ *The Gauge Adaptor Assembly is the window to your system; allows easy reading of the pressure for safe operation.*



Model Number	Gauge Port	Male End	Female End	Gauge Range	
				(psi)	(bar)
GA45GC	G2535L	3/8" NPTF	CR-400	0-10,000	0-700

▼ Shown left to right: GA-3, V-91, GA-1, GA-2, GA-4, NV-251, GA-918







GA, NV, V Series

Operating Pressure:

10,000 psi

▼ A gauge is easily installed into your hydraulic system using a gauge adaptor.



Gauge Adaptors (GA-Series)

- For easy mounting of a pressure gauge into your system
- Male end screws into pump or cylinder port, female end accepts hose or coupler, third port is for gauge connection
- GA-918 provides for swivel connection
- Simplifies gauge installation and reading

Model Number	Gauge Port (NPTF)	Male End (NPTF)	Female End (NPTF)	Dimensions (in)					
				A	B	C	D	E	F
GA-1	1/2" NPTF	3/8" NPTF	3/8"	2.81	1.24	1/2" NPTF	3/8" NPTF	3/8" NPTF	1.25
GA-2	1/2" NPTF	3/8" NPTF		6.10	1.38	1/2" NPTF	3/8" NPTF	3/8" NPTF	1.25
GA-3	1/4" NPTF	3/8" NPTF		5.25	1.38	1/4" NPTF	3/8" NPTF	3/8" NPTF	1.25
GA-4	1/2" NPTF	1/4" NPTF		4.38	1.38	1/2" NPTF	1/4" NPTF	3/8" NPTF	1.25

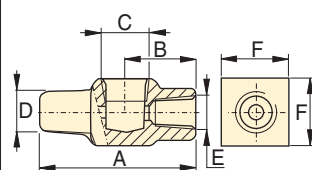

GA-1

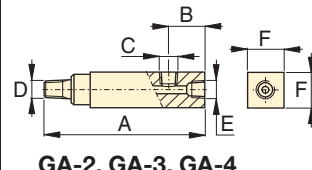

GA-2, GA-3, GA-4





Swivel Adaptor (GA-918)

- Simplifies gauge installation and reading

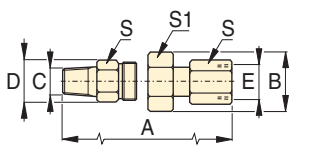
Model Number	Dimensions (in)							
	A	B	C	D	E	S	S1	
GA-918	4.62	1.72	1/2" NPTF	1.30	1/2" NPTF	1.13	1.50	



Needle Valves (NV- and V-Series)

- Both NV-251 and V-91 provide positive shut-off
- 316 stainless steel stem, 24 threads/in.

Model Number	Orifice	Thread Size	Dimensions (in)						
			A	B	C	D	E	F	G
NV-251	.17	1/4" NPT	2.22	.75	.38	1.81	2.25	1.13	.72
V-91	.19	1/2" NPT	3.50	1.44	.63	1.25	2.50	1.25	—

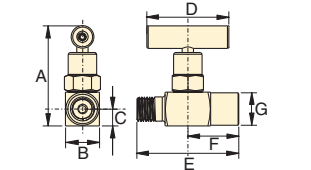

NV-251

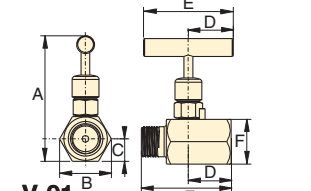

V-91

▼ Shown from left to right: V-152, V-66, V-82, V-161, V-42, V-17



Your Hydraulic Control Solution



Valve Applications

To see these valves used in typical hydraulic circuits, please see our "Yellow Pages".

Page: 264

▼ The V-152 Pressure Relief Valve limits the pressure or force developed in the hydraulic system.

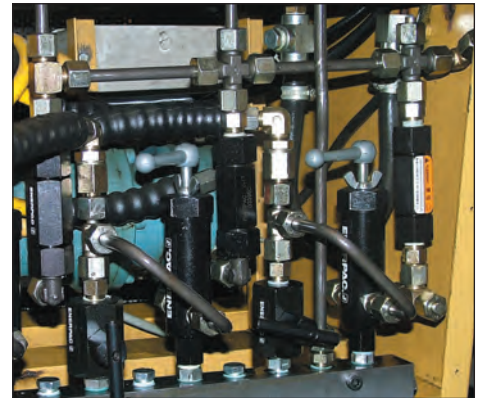

- All valves are rated for 10,000 psi operating pressure
- All valves feature NPTF porting to insure against leakage at rated pressure
- All valves are painted, coated, or plated for corrosion resistance

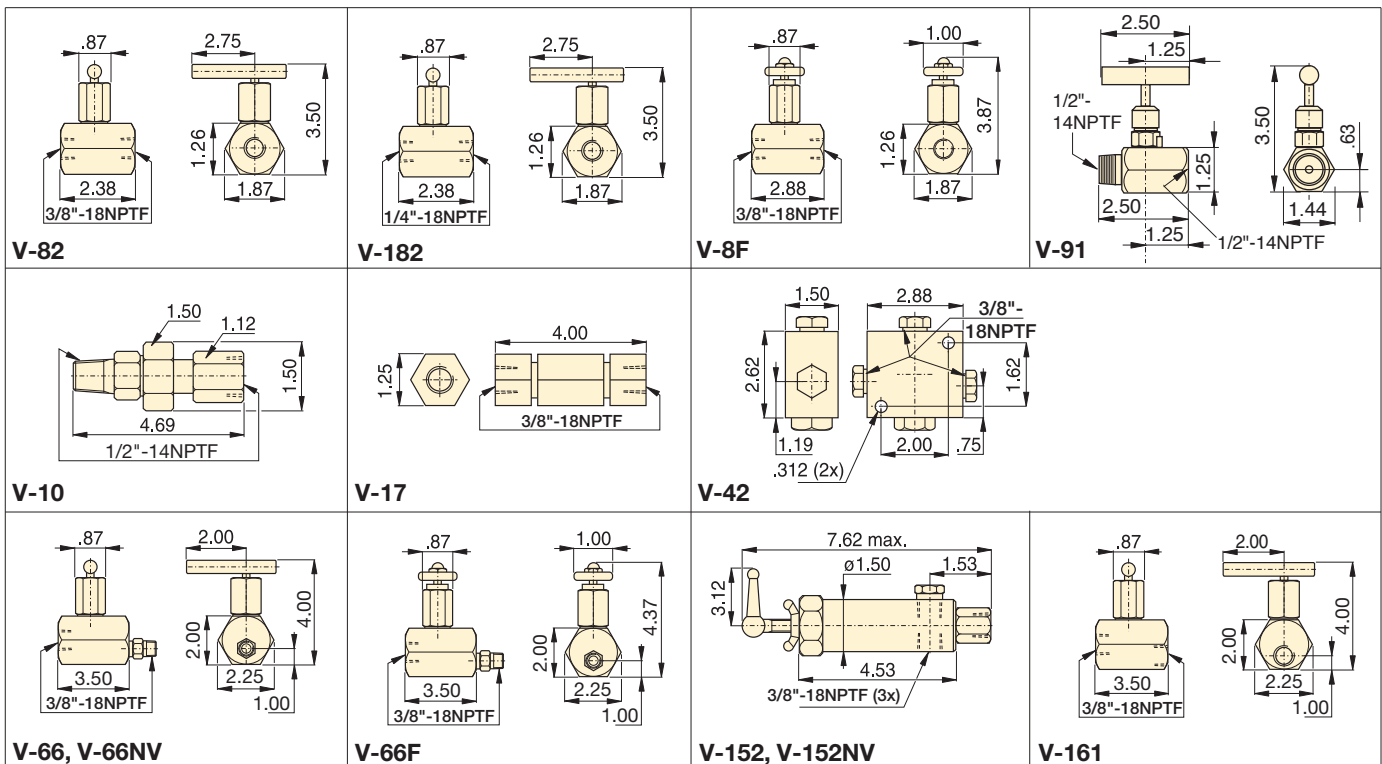

Valve Dimensions in inches.

Flow and Pressure Control Valves



Premounted Manifold

For two or four port manifold with integral flow control valves, see the manifold page of the System Components section.

Page: 136



Fittings

For additional fittings see the fitting page of the System Components section.















Page: 137

V Series

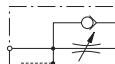

Maximum Operating Pressure:

10,000 psi

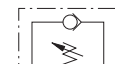
Valve Type and Model Number	Description	Hydraulic Symbol
Needle Valve V-82 V-182F V-8F	 <p>V-82: To control cylinder speed. Can also be used as shut-off valve for temporary load holding. V-8F: Similar to V-82, but with very fine metering for precise flow control. V-182: Same as V-82, but with</p>	 <p>Not recommended as shut-off valve.</p>
Snubber Valve V-91	 <p>V-91: Adjustable for metering oil out of a gauge to prevent snapping of gauge pointer when load or pressure is suddenly released. Also suitable as shut-off valve to protect</p>	
Auto Damper® Valve V-10	 <p>V-10: To be used when gauge pressure must be monitored during high cycle applications. Creates a flow resistance when load is released suddenly.</p>	
Check Valve V-17	 <p>V-17: Ruggedly built to resist shock and operate with low pressure drop. Closes smoothly without pounding. $\frac{3}{8}$" NPTF female ports.</p>	
Pilot Operated Check Valve V-42	 <p>V-42: Can be mounted at the cylinder to hold the load in case of system pressure loss. Normally used with double-acting cylinders where pilot port receives pressure</p>	
Manually Operated Check Valve V66, V66NV* V-66F	 <p>V-66, V66NV: For load holding applications with single- and double-acting cylinders. Valves allow oil to flow back to tank when cylinder retracts. V66NV with Viton seals, nickel-plated.</p>	 <p>V-66F: Similar to V-66, but with very fine metering capability for precise flow control. V-66F not designed for load holding applications.</p>
Pressure Relief Valve V-152 V-152NV*	 <p>V-152: Limits pressure developed by the pump in hydraulic circuit, thus limiting the force created by other components. Valve opens whenever preset pressure is reached.</p>	 <p>To increase pressure setting, turn handle clockwise. Includes:</p> <ul style="list-style-type: none"> • 3 ft return line hose kit • $\pm 3\%$ repeatability • 800-10,000 psi adjustment range.
Sequence Valve V-161	 <p>V-161: To control oil flow to a secondary circuit. Flow is blocked until system pressure rises to the V-161 setting. When this pressure level is reached, the V-161 opens to</p>	 <p>allow flow to the secondary circuit. A pressure differential is always maintained between the primary and secondary circuit. Min. operating pressure: 2000 psi.</p>

* See page 54 for more information about products for use in high temperature and extreme environment applications.

Enerpac Hydraulic Presses are available in a wide variety of standard capacities and configurations, or you can “build your own” with the easy-to-use matrix.

The press frames are a welded construction for maximum strength and durability, and when combined with the power of high-pressure hydraulics, will provide years of safe and dependable service in your workshop.

Enerpac press capacities range from 10-ton to 200-ton and are available in Bench, C-Frame, Arbor, H-Frame and Roll-Frame models.

These press features increase productivity and broaden the range of applications:

Standard on many Enerpac IP Presses, the exclusive Hydra-Lift™ offers effortless adjustment to the press daylight by use of a hydraulic lift.









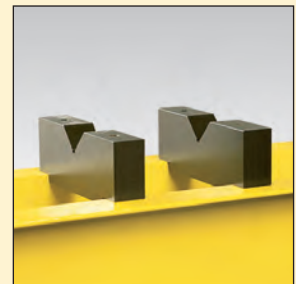

Easy horizontal cylinder position is achieved with the unique “roller-head” cylinder mounting block, standard on most Enerpac IP Presses.



Optional “V-blocks” for positioning of complex parts are designed with high-strength steel for long life.



Press Section Overview

Capacity (tons)	Press Type and Functions	Series		Page
10-200	H-Frame Presses	IP		150 ▶
50-200	Roll Frame Presses	IPR		154 ▶
5-20	C-Clamp Presses	A		156 ▶
10-30	Arbor Presses	A		156 ▶
10	Bench Frame Press	A IP		156 ▶
10-200	Press Accessories Press Speed Chart			158 ▶
10-200	Custom Built Presses	IP		159 ▶
5 1-100	Tension Meter Load Cells	TM LH		160 ▶
	Custom Hydraulic Presses			161 ▶

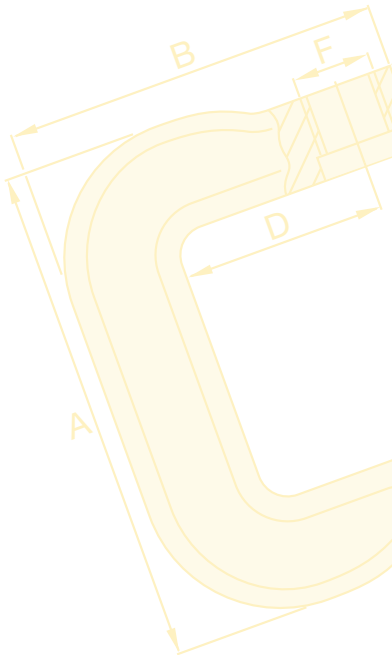

▼ Press shown: IPE-5060



- Quality welded frame for maximum strength and long life
- Exclusive “Hydra-Lift™” bed for effortless adjustment of the vertical daylight (10-ton models are manual)
- Roller head design is standard to allow movement and locking of the cylinder from side to side (10-ton, 25-ton and 30-ton are manual)
- All models in the Quick Selection Chart have been matched to a pump, cylinder, hoses and gauge, offering the complete package



◀ An Enerpac H-Frame press quickly removes the shaft from this assembly.

Setting the Industry Standard



Cylinder Mounting Block

Allows cylinder mounting into a press frame, while also allowing side to side adjustment of cylinder position.

Page: 158



Hydra-Lift™

Allows easy, effortless daylight adjustment. Standard on most H-Frame presses.

Page: 158



Pump Mounting Bracket

Heavy-duty steel brackets allow mounting of one of the Enerpac Power Sources to power your press.

Page: 158



Gauge Included

All standard press models include a gauge and gauge adaptor, matching the press capacity.

Page: 153

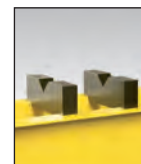

V-Blocks

These optional V-Blocks are designed for easy fixturing of round stock and other non-uniform materials. Featuring precise fit into the press bolster.

Page: 158



Ordering Variations

Any variations to a listed part number must be ordered as two separate items. For example, if you need a different voltage electric pump, please order from the modular matrix on page 159 and the electric pump from the modular matrix on page 99 (electric) or page 111 (air).

Any questions should be directed to our Technical Service Department.

Page: 158



Cylinder Types



= Single-acting, Spring Return



= Double-acting, Hydraulic Return

IP Series



Capacity:

10-200 tons

Maximum Daylight and Width:

54.50 & 48.00 inches

Maximum Operating Pressure:

10,000 psi

▼ QUICK SELECTION CHART

For more technical information see next page.

Press Capacity (tons)	Maximum Vertical Daylight (in)	Maximum Bed Width (in)	Power Source					Press Model Number	Cylinder			Speed (sec/in)*	
			Type			Valve			Stroke (in)	Rapid Advance	Pressing		
			Man.	Elec.	Air	Man.	Elec.						
10	40.00	18.63		●		●		●		10	0.90	6.70	
	40.00	18.63			●	●		●		10	2.20	13.40	
	40.00	18.63	●			●		●		10	{4}	{15}	
	40.00	18.63	●			●			●	10	{2}	{15}	
	40.00	18.63			●	●			●	10	2.20	13.40	
25	54.50	29.00		●		●		●		6	1.50	15.40	
	54.50	29.00		●			●	●		14	.70	7.70	
	54.50	29.00			●	●		●		14	5.20	30.90	
	54.50	29.00	●			●		●		14	{5}	{34}	
30	54.50	29.00			●	●			●	14	.60	43.00	
	54.50	29.00		●			●		●	14	.90	9.80	
	54.50	29.00	●			●			●	14	{7}	{34}	
50	48.56	28.75		●			●	●		13	1.02	11.04	
	48.56	28.75			●	●		●		6	1.00	74.00	
	48.56	28.75	●			●		●		6	{2}	{38}	
	48.56	28.75	●			●		●		6	{11}	{73}	
	48.56	28.75		●		●		●		6	2.90	28.90	
	48.56	28.75			●	●			●	13	1.00	22.20	
	48.56	28.75		●			●		●	13	1.00	11.00	
	48.56	28.75	●			●			●	13	{2}	{38}	
100	42.50	35.00			●	●		●		10	1.90	41.20	
	42.50	35.00		●			●	●		10	1.90	20.60	
	42.50	35.00	●			●		●		10	{3}	{70}	
	42.50	35.00		●			●		●	13	1.90	20.60	
	42.50	35.00	●			●			●	6	{3}	{70}	
150	48.50	48.00		●			●	●		13	2.20	15.40	
200	48.50	48.00		●			●	●		13	3.10	22.10	

* {-} Speed in strokes per inch plunger travel

▼ The moveable “cylinder mounting block” allows the user to quickly adapt the press to a specific job.



◀ For full features see page 137.

Press Capacity (tons)	Press Model Number	Pump Model Number	Page:	Cylinder Model Number	Page:	H-Frame Press Dimensions (in)					
						A (max)	A (min)	B	C	D	E
10	IPE-1215	PEM-1201B	84	RC-1010	6	40.00	2.44	–	46.75	5.00	18.63
	IPA-1220	XA-12	108	RC-1010	6	40.00	2.44	–	46.75	5.00	18.63
	IPH-1240	P-392	70	RC-1010	6	40.00	2.44	–	46.75	5.00	18.63
	IPH-1234	P-84	72	RR-1010	32	40.00	2.44	–	46.75	5.00	18.63
	IPA-1244	XA-12V	108	RR-1010	32	40.00	2.44	–	46.75	5.00	18.63
25	IPE-2505	PUJ-1200B	82	RC-256	6	54.50	7.00	–	57.00	11.88	29.00
	IPE-2510	ZE3310SB-N	96	RC-2514	6	54.50	7.00	–	57.00	11.88	29.00
	IPA-2520	XA-12	108	RC-2514	6	54.50	7.00	–	57.00	11.88	29.00
	IPH-2531	P-80	72	RC-2514	6	54.50	7.00	–	57.00	11.88	29.00
30	IPA-3071	PAM-1042	105	RR-3014	32	54.50	7.00	–	57.00	11.88	29.00
	IPE-3060	ZE3410SB-N	96	RR-3014	32	54.50	7.00	–	57.00	11.88	29.00
	IPH-3080	P-84	72	RR-3014	32	54.50	7.00	–	57.00	11.88	29.00
50	IPE-5010	ZE4320SB-N	96	RC-5013	6	48.56	7.06	18.76	54.00	10.38	28.75
	IPA-5021	PAM-1022	105	RC-506	6	48.56	7.06	18.76	54.00	10.38	28.75
	IPH-5030	P-462	72	RC-506	6	48.56	7.06	18.76	54.00	10.38	28.75
	IPH-5031	P-80	72	RC-506	6	48.56	7.06	18.76	54.00	10.38	28.75
	IPE-5005	PUJ-1200B	82	RC-506	6	48.56	7.06	18.76	54.00	10.38	28.75
	IPA-5073	ZA4408MX	110	RR-5013	32	48.56	7.06	18.76	54.00	10.38	28.75
	IPE-5060	ZE4420SB-N	96	RR-5013	32	48.56	7.06	18.76	54.00	10.38	28.75
	IPH-5080	P-464	72	RR-5013	32	48.56	7.06	18.76	54.00	10.38	28.75
100	IPA-10023	ZA4208MX	110	RC-10010	6	42.50	7.00	20.00	51.00	11.69	35.00
	IPE-10010	ZE4320SB-N	96	RC-10010	6	42.50	7.00	20.00	51.00	11.69	35.00
	IPH-10030	P-462	72	RC-10010	6	42.50	7.00	20.00	51.00	11.69	35.00
	IPE-10060	ZE4420SB-N	96	RR-10013	32	42.50	7.00	20.00	51.00	11.69	35.00
	IPH-10080	P-464	72	RR-1006	32	42.50	7.00	20.00	51.00	11.69	35.00
150	IPE-15065	ZE5420SG-N	96	RR-15013	32	48.50	12.50	28.00	54.50	10.00	48.00
200	IPE-20065	ZE5420SG-N	96	RR-20013	32	48.50	12.50	28.00	54.50	10.00	48.00

IP Series



Capacity:
10-200 tons

Maximum Daylight and Width:
54.50 & 48.00 inches

Maximum Operating Pressure:
10,000 psi

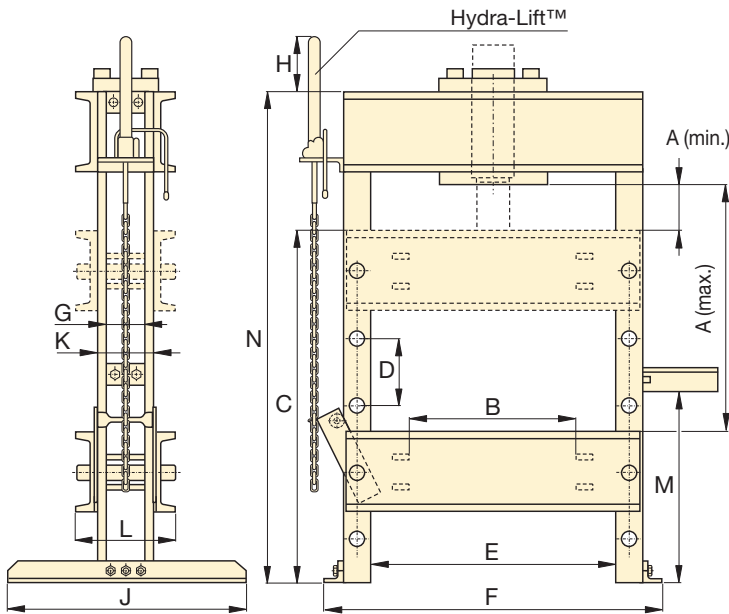

H-Frame Press Dimensions (in)								Weight (lbs)	Press Model Number
F	G	H	J	K	L	M	N		
24.88	-	-	29.75	4.25	7.44	35.00	52.00	298	IPE-1215
24.88	-	-	29.75	4.25	7.44	35.00	52.00	160	IPA-1220
24.88	-	-	29.75	4.25	7.44	35.00	52.00	158	IPH-1240
24.88	-	-	29.75	4.25	7.44	35.00	52.00	189	IPH-1234
24.88	-	-	29.75	4.25	7.44	35.00	52.00	163	IPA-1244
40.50	4.00	13.25	30.00	5.25	10.69	26.50	76.00	605	IPE-2505
40.50	4.00	13.25	30.00	5.25	10.69	26.50	76.00	697	IPE-2510
40.50	4.00	13.25	30.00	5.25	10.69	26.50	76.00	610	IPA-2520
40.50	4.00	13.25	30.00	5.25	10.69	26.50	76.00	620	IPH-2531
40.50	4.00	13.25	30.00	5.25	10.69	26.50	76.00	684	IPA-3071
40.50	4.00	13.25	30.00	5.25	10.69	26.50	76.00	722	IPE-3060
40.50	4.00	13.25	30.00	5.25	10.69	26.50	76.00	664	IPH-3080
42.75	5.00	8.75	36.00	7.25	14.38	30.75	76.00	1,040	IPE-5010
42.75	5.00	8.75	36.00	7.25	14.38	30.75	76.00	968	IPA-5021
42.75	5.00	8.75	36.00	7.25	14.38	30.75	76.00	968	IPH-5030
42.75	5.00	8.75	36.00	7.25	14.38	30.75	76.00	926	IPH-5031
42.75	5.00	8.75	36.00	7.25	14.38	30.75	76.00	930	IPE-5005
42.75	5.00	8.75	36.00	7.25	14.38	30.75	76.00	1,057	IPA-5073
42.75	5.00	8.75	36.00	7.25	14.38	30.75	76.00	1,051	IPE-5060
42.75	5.00	8.75	36.00	7.25	14.38	30.75	76.00	1,003	IPH-5080
51.00	6.75	8.75	36.00	8.75	17.25	33.13	76.00	1,650	IPA-10023
51.00	6.75	8.75	36.00	8.75	17.25	33.13	76.00	1,722	IPE-10010
51.00	6.75	8.75	36.00	8.75	17.25	33.13	76.00	1,656	IPH-10030
51.00	6.75	8.75	36.00	8.75	17.25	33.13	76.00	1,743	IPE-10060
51.00	6.75	8.75	36.00	8.75	17.25	33.13	76.00	1,665	IPH-10080
67.17	9.12	3.09	44.00	13.12	21.85	47.75	90.00	3,906	IPE-15065
67.17	9.12	3.09	44.00	13.12	21.85	47.75	90.00	3,906	IPE-20065



H-Frame Press Gauges

All standard press models include a gauge and gauge adaptor, matching the press capacity:

Press Capacity	Gauge Model Number	Adaptor Model Number
(tons)		
10	GF-10P	GA-2
25	GF-20P	GA-2
30	GF-835P	GA-3
50	GF-50P	GA-2
100	GF-871P	GA-3
150	GF-200P	GA-3
200	GF-200P	GA-3

For more information on gauges, please refer to the System Components section.

Page: 131



Ordering Variations

Any variations to a listed part number must be ordered as two separate items. For example, if you need a different voltage electric pump, please order from the modular matrix on page 159 and the electric pump from the modular matrix on page 99 (electric) or page 111 (air).

Any questions should be directed to our Technical Service Department.

Page: 158

▼ Shown: IPR-10075



- Quality welded frame for maximum strength and long life
- Frame rolls easily on four steel roller bearings
- Hydraulic clamp cylinders lock frame into position
- Exclusive “Hydra-Lift™” bolster for effortless adjustment of the vertical daylight
- Standard roller head design allows movement of the cylinder from side to side
- All models in the Quick Selection Chart have been matched to a pump, cylinder, hoses and gauge, offering the complete package
- Roll Frame design features a stationary bed with the ability to support heavy loads

The One and Only



Cylinder Mounting Block

Allows cylinder mounting into a press frame, while also allowing side to side adjustment of cylinder position.

Page: 158



Pump Mounting Bracket

Heavy duty steel brackets to allow conversion to one of the Enerpac Power Sources to power your press.

Page: 158



Hydra-Lift™

Allows easy, effortless daylight adjustment.

Page: 158

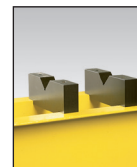

Optional V-Blocks

These V-Blocks, 200 ton only, are designed for easy fixturing of round stock and other non-uniform materials. Featuring precise fit into the press bolster.

Page: 158

Press Capacity (tons)	Vertical Daylight A (in)		Horizontal Daylight E (in)	Pump Model Number	Press Model Number	Cylinder, Double-Acting Hydraulic Return				Speed (sec/in)	
	minimum	maximum					Stroke (in)	Model Number	Page:	Rapid Advance	Pressing
50	6.00	37.12	28.75	ZE4420SB-N	96 IPR-5075	●	13.13	RR-5013	33	1.0	11.1
100	6.28	41.28	35.00	ZE5420SG-N	96 IPR-10075	●	13.13	RR-10013	33	1.5	10.3
200	11.00	51.00	48.00	ZE5420SG-N	96 IPR-20075	●	13.00	RR-20013	33	3.1	22.1

Roll Frame Presses

▼ An IPR-20075 Roll Frame Press is used to remove a large shaft from this pillow-block assembly. The Roll Frame design allows this heavy part to be safely loaded with an overhead crane.



IPR Series



Capacity:
50-200 tons

Maximum Daylight and Width:
51.00 & 48.00 inches

Maximum Operating Pressure:
10,000 psi



Roll Frame Press Gauges

All standard press models include a gauge and gauge adaptor, matching the press capacity:

Press Capacity (tons)	Gauge Model Number	Adaptor Model Number
50	GF-50P	GA-2
100	GF-871P	GA-3
200	GF-200P	GA-3

For more information on gauges, please refer to the System Components section.

Page: 131



Ordering Variations

Any variations to a listed part number must be ordered as two separate items. For example, if you need a different voltage electric pump, please order from the modular matrix on page 159 and the electric pump from the modular matrix on page 99 (electric) or page 111 (air).

Any questions should be directed to our Technical Service Department.

Page: 158

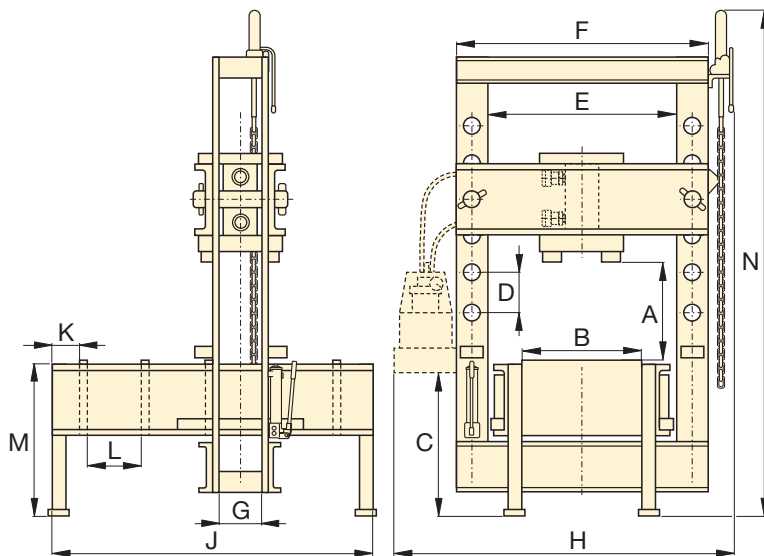

Roll Frame Press Dimensions (in)

Roll Frame Press Dimensions (in)												Weight	Press Model Number
B	C	D	F	G	H	J	K	L	M	N	(lbs)		
20.71	38.25	10.38	36.75	5.00	55.92	64.00	8.00	10.63	30.00	112.96	1,961	IPR-5075	
26.50	38.00	8.75	45.00	5.75	63.19	66.00	8.00	10.63	32.00	118.94	3,849	IPR-10075	
38.75	36.75	10.00	64.00	9.12	84.63	86.50	8.00	15.00	36.00	125.96	7,869	IPR-20075	

▼ Shown from left to right: A-220, A-330 and A-258



The Standard In Workshop Tools



Push Pin A-183

For applications requiring precision pressing, such as shaft removal and insertion. This attachment fits 10 ton cylinders and requires the use of a threaded adaptor saddle (A-13).



Smooth Saddle A-185

For pressing applications of delicate parts, such as aluminum castings, this saddle decreases surface marks during the pressing application. Requires 10-ton cylinder and threaded adaptor saddle (A-13).

C-Clamp Press

- 5, 10 and 20 ton capacity
- Operational in all positions

Arbor Press

- Foot mounting holes for horizontal or vertical positioning
- Machined work surfaces for easier fixturing
- Slotted back to simplify loading and unloading of longer parts

Bench Frame Press

- Cylinder mounting adaptor allows lateral positioning along rails
- Mounting holes for easy mounting to fixed surface

▼ A-310 Arbor Press



Press Type	Press Capacity (tons)	Maximum Vertical Daylight (in)	Maximum Bed Width (in)	Cylinder Series Number*	Press Model Number	Weight (lbs)
Arbor	10	8.94	5.31	RC-10-x	A-310*	62
	30	10.25	7.00	RC-30-x	A-330*	220
C-Clamp	5	6.50	2.00	RC-5-x	A-205*	14
	10	9.00	3.25	RC-10-x	A-210*	37
	20	11.88	3.75	**	A-220**	83
Bench	10	15.38	15.00	–	A-258*	103
	10	15.38	15.00	RC-1010	IPA-1022***	140
	10	15.38	15.00	RC-1010	IPH-1040***	135

* Requires RC cylinder listed, see page 7 for specifications.

** Requires RC-25 ton cylinder, limited to 20 tons.

*** Complete set includes cylinder and pump.

C-Clamp, Arbor and Bench Frame Presses

▼ A perfect example of the force and versatility of the Enerpac A-220 C-Clamp press.



A IP Series



Capacity:
5-30 ton

Maximum Daylight and Width:
15.38 and 15.00 inches

Mounting Capabilities:
Fixed or Portable

Maximum Operating Pressure:
10,000 psi



For high-cycle production applications, C-Clamp and Arbor presses should be limited in their capacity.

Consult Enerpac Technical Services for specific application details.

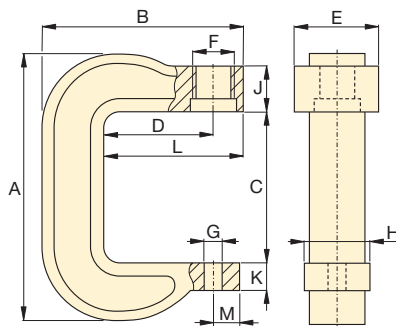

C-Clamp Press A-205, A-210, A-220

Top View Working Surface

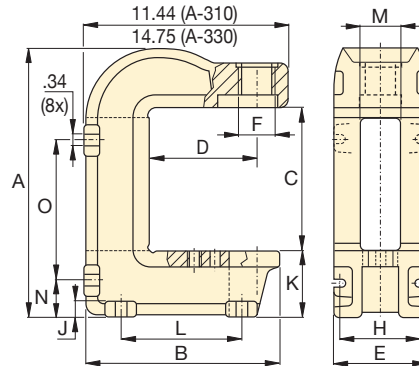
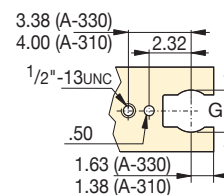

Arbor Press A-310, A-330

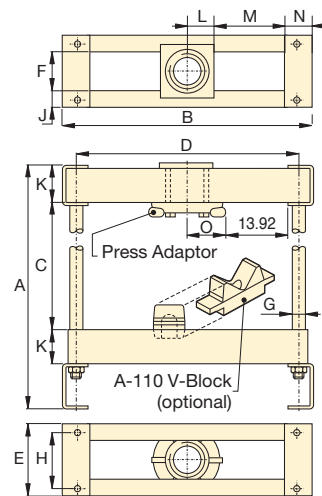

Bench Press Frame A-258



Hydraulic Cylinders

Cylinders for C-Clamps and Arbor Presses must be ordered separately.

Page: 6



Hydraulic Pumps

Pumps for C-Clamps and Arbor Presses must be ordered separately.

Page: 69

Press Dimensions (in)

Press Dimensions (in)														Press Model Number
A	B	C	D	E	F	G	H	J	K	L	M	N	O	
16.31	11.06	8.94	6.00	5.31	2 1/4-14 UN	2.50	4.81	.75	3.81	6.88	2.56	2.13	8.63	A-310
21.94	13.88	10.25	6.00	7.00	3 5/16-12 UN	2.50	5.50	1.00	6.50	8.00	2.63	3.88	10.88	A-330
11.44	8.00	6.50	3.75	2.88	1 1/2-16 UN	1.02	2.00	2.50	1.06	4.75	1.00	-	-	A-205
16.00	11.13	9.00	6.00	3.25	2 1/4-14 UN	1.02	2.25	2.50	1.69	7.63	1.13	-	-	A-210
21.25	13.63	11.88	6.00	4.76	3 5/16-12 UN	1.02	2.75	2.75	1.88	8.38	1.13	-	-	A-220
25.63	18.75	16.50	16.00	5.75	3.25	1.00	4.50	1.25	2.75	1.88	5.30	2.20	2.63	A-258
25.63	18.75	16.50	16.00	5.75	3.25	1.00	4.50	1.25	2.75	1.88	5.30	2.20	2.63	IPA-1022
25.63	18.75	16.50	16.00	5.75	3.25	1.00	4.50	1.25	2.75	1.88	5.30	2.20	2.63	IPH-1040

Description	Frame Capacity	Model Number		Features
Cylinder Mounting Block	10 ton Bench 10 ton H-Frame 25 and 30 ton H-Frame 50 ton H-Frame 100 ton H-Frame 200 ton H-Frame	AD-175 IPK-1012 IPK-3012 PK-501 PK-1002 PK-2002		<ul style="list-style-type: none"> AD-175 converts the Bench press to use an RD-9 ton cylinder All mounting blocks allow horizontal movement of cylinder
V- Blocks	10 ton Bench Press 10 ton H-Frame 25 and 30 ton H-Frame 50 ton H-Frame 100 ton H-Frame 150 & 200 ton H-Frame 200 ton Roll Frame	A-110 A-136 A-130 A-150 A-175 A-200 A-200R		<ul style="list-style-type: none"> Machined from high strength steel for long life A-110 includes one V-block All other model numbers include two V-blocks
Hydra-Lift™	25-100 ton H-Frame 150-200 ton H-Frame 50 and 100 ton Roll Frame 200 ton Roll Frame	IPL-100 IPL-101 IPLR-100 IPLR-200		<ul style="list-style-type: none"> Allows easy, effortless daylight adjustments Includes accessory chain
Pump Mounting Bracket	Hand operated and small Air Pumps; P-80, P-84, P-142, P-392, PA-133, XA, Turbo II pumps Electric, large Hand Pumps, and ZA4 Air Pumps; ZE Series, P-462, P-464, 10/90 Series Air Pumps	PMB-1 PMB-2		<ul style="list-style-type: none"> Both mounting brackets are pre-drilled to accept a number of different pump models

Cylinder Speed

This chart will help you calculate the time required for an Enerpac cylinder to extend when powered by a 10,000 psi Enerpac hydraulic pump. The Cylinder Speed Chart can also be used to determine the pump type and model best suited for an application when you know the plunger speed required.

Cylinder and Pump Selection Chart

Cylinder Capacity (tons)	Cylinder Load	Hand Operated Pumps				Electric Pumps					Air Pumps			
		Strokes per inch of plunger travel				Seconds per inch of plunger travel					@100 psi air			
		Single Speed P-391	Two-Speed			½ hp Port.	½ hp Subm.	ZE3 Series	ZE4 Series	ZE5 Series	XA	PA-133	PAM 10 Series	ZA4
			P-392	P-80 P-84	P-462 P-464									
10	No load	15	4	2	1	.7	.9	.3	.2	.2	1.10	2.70	.21	.16
	Load	15	15	15	8	6.7	6.7	3.4	2.2	1.1	9.00	16.80	14.90	4.50
25	No load	34	8	5	1	1.5	2.1	.7	.5	.4	2.60	6.20	.48	.36
	Load	34	34	34	18	15.5	15.5	7.7	5.2	2.6	20.60	38.60	34.30	10.30
30	No load	43	10	7	1	1.9	2.6	.9	.6	.5	3.20	7.50	.60	.46
	Load	43	43	43	23	19.5	19.5	9.80	6.5	3.3	26.00	48.70	43.30	13.00
50	No load	73	16	11	2	3.3	4.4	1.50	1.0	.8	5.50	13.30	1.00	.80
	Load	73	73	73	38	33.2	33.2	16.6	11.0	5.5	44.20	82.92	73.70	22.10
100	No load	137	30	21	3	6.2	8.3	2.8	1.9	1.5	10.30	24.80	1.90	1.50
	Load	137	137	137	71	61.9	61.9	31.0	20.7	10.3	82.50	154.70	137.50	41.30

Note: Values are approximate. Cylinder speed may vary in actual application.

CUSTOM BUILD YOUR OWN PRESS

If the press that would best fit your application cannot be found in the charts, you can easily build your custom press here. All presses must be ordered with cylinders. The pump is ordered separately.

▼ This is how a press model number is built up:

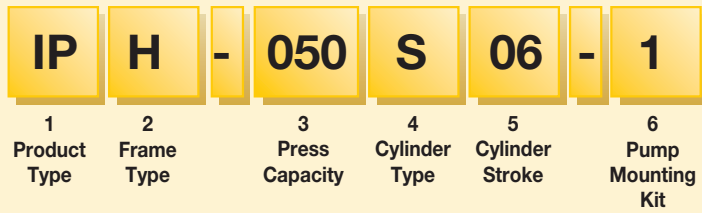

1 Product Type

IP= Industrial Press

2 Frame Type

H = H-Frame
R = Roll Frame ¹⁾

3 Press Capacity

010 = 10 ton
025 = 25 ton
030 = 30 ton
050 = 50 ton
100 = 100 ton
150 = 150 ton
200 = 200 ton

4 Cylinder Type

S = Single-Acting (RC-Series)
D = Double-Acting (RR-Series)

5 Cylinder Stroke (in)

- 10 ton S/A: **06, 08, 10, 12, 14**
10 ton D/A: **10, 12**
- 25 ton S/A: **06, 10, 12, 14**
30 ton S/A: **08**
30 ton D/A: **08, 14**
- 50 ton S/A: **06, 13**
50 ton D/A: **06, 13, 20**
- 100 ton S/A: **06, 10**
100 ton D/A: **06, 13, 18**
- 150 ton D/A: **06, 13, 32**
- 200 ton D/A: **13, 18, 24**

6 Pump Mounting Kit ²⁾

0 = No mounting kit
1 = Hand operated and small air pumps: P-80, P-84, P-141, P-142, P-202, P-391, P-392, PA-133 and all Turbo II Air pumps
2 = Electric, large hand operated and modular air pumps: PUJ-12, PEM-12, ZE3-6 Series P-462, P-464 PAM-10 and -90 Series

¹⁾ Roll Frame Press: 50-, 100- and 200-ton press capacity only. (Assembly required)

²⁾ Includes hoses for press, except for option 0.

Ordering Example

Model number: IPH-050S06-2

IPH-050S06-2 is a 50-ton H-Frame press with a single-acting, 6 inch stroke cylinder (RC-506). It has a pump mounting kit (for an electric Pump or a Modular Air Pump).

See the cylinder and pump selection chart on previous page for selecting the proper pump.

IP Series



Capacity:

10-200 tons

Maximum Daylight and Width:

54.50 & 48.00 inches

Maximum Operating Pressure:

10,000 psi



“No Load” indicates the plunger speed as it extends toward the load (1st stage).

“Load” indicates the plunger speed as the load is applied at a system pressure of 10,000 psi (2nd stage).

Formula $V = A \div Q$

V (sec/in) = A (in²) ÷ Q (in³/min)

V = Cylinder plunger speed in seconds per inch

A = Cylinder effective area in square inches (in²)

Q = Pump oil flow in cubic inches (in³)

Cylinder Plunger Speed (sec/in)	=	Cylinder Effective Area (in ²) Pump Flow Rate (in ³ /min)	x	$\frac{60 \text{ sec}}{1}$
---------------------------------	---	---	---	----------------------------

▼ Shown: LH-102 and TM-5 (in middle)



TM, LH Series

Capacity:
2,000 to 200,000 lbs.

Accuracy, % of full scale:
± 2%



TM and LH models are 100% tested to verify accuracy within a ± 2% range.

If your application requires a calibrated tool, it must be submitted for certification testing.

Certification is NOT available from Enerpac.

Tension Meter TM-5

- Accuracy, ± 2% of full scale
- Zinc and bronze plated to resist rust and corrosion
- Dual-range readout in kilograms and pounds
- Cushioned metal case provides safe storage and transport
- Maximum indicating pointer reading for pre-selected forces or to maintain maximum force readings

Load Cells LH Series

- Accuracy, ± 2% of full scale
- Swivel loading pad reduces eccentric loading for improved accuracy
- Maximum indicating pointer reading for pre-selected forces or to maintain maximum force readings
- Dual-range readout in kilograms and pounds

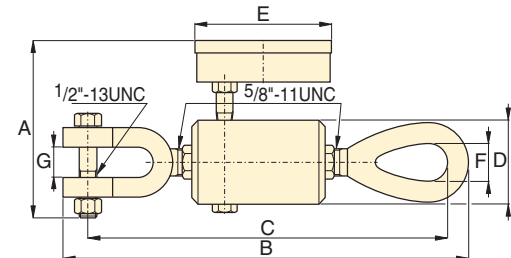

TM-5

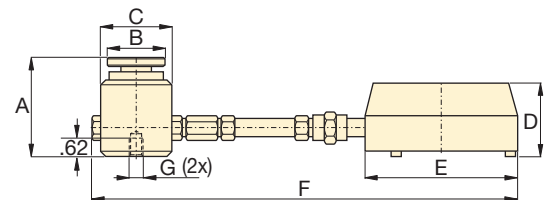

LH-Series

Type	Gauge Capacity		Model Number	Minimum Reading		Gauge Increments		Dimensions (in)						
	(lbs)	(kg)		(lbs)	(kg)	(lbs)	(kg)	A	B	C	D	E	F	G
Direct Mounted	10,000	4500	TM-5	1,000	500	100	100	4.75	9.75	9.29	2.00	4.00	.88	.75
Direct Load Cell Mounted	2,000	900	LH-10	200	100	20	20	3.06	1.75	2.25	2.38	4.00	10.00	1/4\"-20, 1.75\" BC
	10,000	4500	LH-50	1,000	500	100	100	3.06	1.75	2.25	2.38	4.00	10.00	1/4\"-20, 1.75\" BC
Remote Mounted with 2 ft. Hose	2,000	900	LH-102	200	100	20	20	3.06	1.75	2.25	2.38	5.81	33.31	1/4\"-20, 1.75\" BC
	10,000	4500	LH-502	1,000	500	100	100	3.06	1.75	2.25	2.38	5.81	33.10	1/4\"-20, 1.75\" BC
	20,000	9000	LH-1002	2,000	1000	200	200	3.06	1.75	2.25	2.38	5.81	33.10	1/4\"-20, 1.75\" BC
Remote Mounted with 6 ft. Hose	50,000	21000	LH-2506	5,000	2500	500	500	4.00	2.75	3.38	2.38	5.81	82.44	3/8\"-24, 2.5\" BC
	100,000	45000	LH-5006	5,000	2500	1,000	1000	5.22	4.00	5.00	2.38	5.81	84.06	3/8\"-24, 3.5\" BC
	200,000	90000	LH-10006	20,000	10000	2,500	1000	6.22	5.00	6.25	2.38	5.81	85.31	3/8\"-24, 4.0\" BC

With decades of experience and in-house capabilities look to Enerpac to help find solutions to your customization needs.

Next to our large range of standard workshop presses, Enerpac offers the possibility of customization. Because many customers have specific requirements, we offer turn-key project management, including design, engineering and manufacturing. As the market leader, we listen to our customers and with our world

wide experience we offer the best solutions, especially when safety is not negotiable. Whether a longer stroke, wider frame or complete new design is required, our custom product group has many years of experience in multiple industries to deliver a solution that meets or exceeds expectations.



◀ *Fully Automated PLC-Controlled 1800-Ton, High-Accuracy Press*



◀ *50-Ton Workshop Press for Maintenance Jobs*



◀ *100-Ton Press for Assembly of Spring-Loaded Cylinders*

OVERVIEW

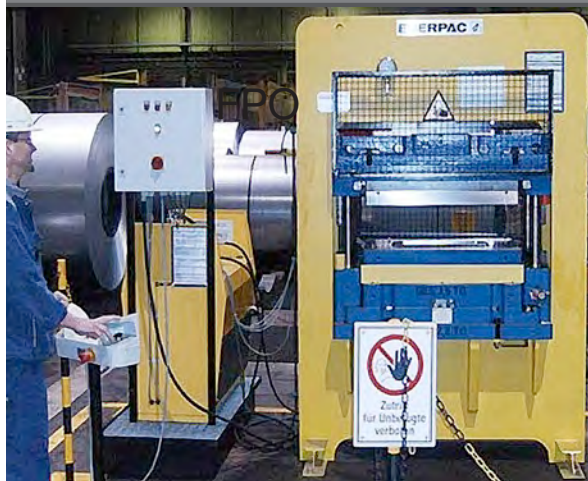

▲ *Enerpac's hydraulic presses can be configured to fulfill a broad range of applications. Each press is designed and manufactured according to customer specifications and in cooperation with our engineering team.*

CUSTOMIZABLE FEATURES:

- Capacity
- Cylinder Stroke
- Pump Type
- Controls
- Guarding
- Daylight Dimensions

CONFIGURATIONS

- Vertical and horizontal press
- Cylinders mounted in upper and lower bolsters
- Height built to customer specifications
- Daylight (vertical and horizontal) built to customer specifications

Enerpac offers a complete line of pullers with the widest range of sizes, capacities and styles. Whether your application requires mechanical, hydraulic or the patented Posi Lock® system, Enerpac can satisfy your requirements.

Made of high strength steel alloys, you can depend on Enerpac pullers to provide years of trouble-free operation, even in the harshest environments.



Hydraulic Pullers

These hydraulic pullers eliminate time-consuming and unsafe hammering, heating or prying. Damage to parts is minimized through the use of controlled hydraulic power.



Posi Lock® Pullers

The puller that meets the safety challenge. A control cage holds the pulling jaws securely in working position. This patented feature reduces the possibility of the puller jaws slipping off the work surface thereby increasing productivity and tool life while reducing dangerous situations for the user. The Posi Lock® feature is available in mechanical or hydraulic versions.



WARNING

Do not exceed 50% of the rated puller capacity when using a double crosshead (2 jaws) or when using puller legs in combination with bearing puller attachment.



CAUTION!

Not all puller components and configurations are rated at the set capacity. Please contact Enerpac for specific details.



Always wear Safety Goggles and Gloves while using pullers.

When selecting a puller it is important to consider three basic specifications:

1. Capacity:

The amount of force the puller is capable of producing.

Typically, the capacity required for a job can be determined by using the shaft diameter of the part being pulled.

For manual pullers, the center bolt diameter of the puller should be at least half the diameter of the shaft being pulled from.

For hydraulic pullers, the capacity in tons should be 7 to 10 times the shaft diameter. Use the following chart:











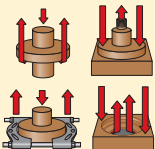

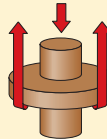

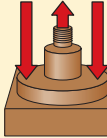



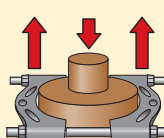

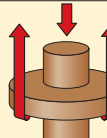
Shaft Diameter	Puller Capacity
0" to 1"	14 ton
1" to 2"	24 ton
2" to 3.5"	36 ton
3.5" to 5.5"	50 ton

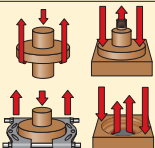
2. Reach:

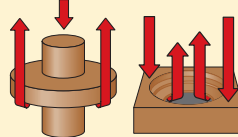
The distance between the bottom of the base and the jaw flats. The puller's reach must equal or exceed the same distance of the part being pulled.

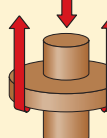
3. Spread:

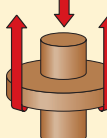
The distance between the jaws. The puller's spread needs to be greater than the width of the part being pulled.

Puller Function	Capacity (tons)	Puller Type	Series	Image	Page
	14-50	Master Puller Sets Max. Reach: 27.56 in. Spread Range: 43.30 in.	BHP		164 ▶
	14-50	Grip Puller Sets Max. Reach: 27.56 in. Spread Range: 43.30 in.	BHP		165 ▶
	7-24	Cross-Bearing Puller Sets Max. Reach: 34.00 in. Spread Range: 22.44 in.	BHP		166 ▶ 173
	7-25	Bearing Cup Pullers Max. Reach: 5.71 in. Spread Range 14.17 in.	BHP		167 ▶
	7-25	Bearing Separator Max. Spread: 9.65 in. Max. Width 11.50 in.	BHP		167 ▶
	1-20	Mechanical Sync Grip Puller Max. Reach: 23.62 Spread Range: 26.77	SGM		168 ▶
	14-50	Hydraulic Sync Grip Puller Max. Reach: 27.56 in. Spread Range: 38.58 in.	SGH MPS GPS		168 ▶ 171 ▶ 172 ▶
	2-40	Posi Lock® Mechanical Pullers Max. Reach: 14.00 in. Spread Range: 25.00 in.	EP, EPP, EPPMI, EPX		174 ▶
	10-50	Posi Lock® Hydraulic Pullers Max. Reach: 14.00 in. Spread Range: 25.00 in.	EPH, EPHR, EPHS		178 ▶
	100	Posi Lock® Hydraulic Pullers Max. Reach: 48.0 in. Spread Range: 70.0 in.	EPH EPHT		181 ▶

▼ Shown: Master Puller Set BHP-3751G



Multi-Purpose Puller Set



WARNING

Not all puller components and configurations are rated at the set capacity. Please contact Enerpac for specific details.

- Supplied with a full hydraulic set including pump, hose, cylinder, gauge and gauge adaptor in a storage case
- High quality, forged steel components provide superior reliability and service
- Sets include speed crank and adjusting screw for fast contact to work before hydraulics are applied
- All Master Puller Sets include a Grip Puller, a Cross Bearing Puller, a Bearing Cup Puller and a Bearing Separator which can be ordered separately. See items 10, 20, 30 and 40

▼ Maintenance engineers throughout the industry greatly appreciate Enerpac Master Puller sets.



▼ SELECTION CHART

Master Puller Set Capacity	14 ton	24 ton	36 ton	50 ton*	Page Number
Model Number ►	BHP-1752 ¹⁾	BHP-2751G	BHP-3751G	BHP-5751G	
Included Hydraulics: Set Weight ►	82 lbs	198 lbs	380 lbs	657 lbs	
Hand Pump	P-142	P-392	P-392	P-80	70 ►
Cylinder	RWH-121	RCH-202	RCH-302	RCH-603	26 ►
Saddle	–	HP-2015	HP-3015	HP-5016	27 ►
Hose	HB-7206QB	HC-7206	HC-7206	HC-7206	133 ►
Gauge	GF-120P	GF-813P	GF-813P	GF-813P	139 ►
Gauge Adaptor	GA-4	GA-3	GA-3	GA-3	145 ►
Included Pullers:					
10 Grip Puller	BHP-1762	BHP-252	BHP-352	BHP-552	165 ►
20 Cross Bearing Puller	BHP-1772	BHP-262	BHP-362	BHP-562	166 ►
30 Bearing Cup Puller	BHP-180	BHP-280	BHP-380	BHP-580	167 ►
40 Bearing Separator	BHP-181	BHP-282	BHP-382	BHP-582	167 ►
Storage Case	CM-6	CW-166	CW-550	CW-750	

¹⁾ Includes FZ-1630 Adaptor.

* Puller capacity at 7,850 psi

▼ Shown: Grip Puller Set BHP-351G



- Precise hydraulic control allows fast, efficient and safe pulling
- High quality, forged steel components provide superior reliability and service
- Available with and without full hydraulic set

BHP Series

Capacity:

14, 24, 36 and 50 tons

Maximum Reach:

9.92-27.56 inches

Spread Range:

9.84-43.30 inches

Maximum Operating Pressure:

10,000 psi



WARNING

Not all puller components and configurations are rated at the set capacity. Please contact Enerpac for specific details.

Ordering Example

Model Number BHP-251G:

Includes Grip Puller BHP-252 and a full hydraulic set. (Hand pump, cylinder, saddle, hose, gauge and gauge adaptor.)

Model Number BHP-252:

Includes Grip Puller mechanical parts **only**, for use with your existing hydraulics.

▼ SELECTION CHART

Grip Puller Set Capacity		14 ton	24 ton	36 ton	50 ton**
Model Number	Included ▶	BHP-152 ¹⁾	BHP-251G	BHP-351G	BHP-551G
Hydraulics:	set weight ▶	48 lbs	123 lbs	200 lbs	353 lbs
Hand Pump		P-142	P-392	P-392	P-80
Cylinder		RWH-121	RCH-202	RCH-302	RCH-603
Saddle		-	HP-2015	HP-3015	HP-5016
Hose		HB-7206QB	HC-7206	HC-7206	HC-7206
Gauge		GF-120P	GF-813P	GF-813P	GF-813P
Gauge Adaptor		GA-4	GA-3	GA-3	GA-3
10 Grip Puller *	Model Number ▶	BHP-1762*	BHP-252*	BHP-352*	BHP-552*
Spread Range (in)	2-jaw	9.84	15.75	23.38	35.43
	3-jaw	9.84	19.68	31.50	43.30
Maximum Reach (in)	2-jaw	9.92	11.81	15.25	27.56
	3-jaw	9.92	11.81	15.25	27.56
Jaw (in)	Thickness	0.59	0.79	0.98	1.18
	Width	0.94	1.10	1.50	1.57
Adjusting Screw (in)	Thread	¾"-16 UNF	1"-8 UNC	1¼"-7 UNC	1½"-5.5 UNS
	Length	15.75	26.38	31.16	38.39
Case		CW-166	CW-166	CW-350	CW-750

¹⁾ Includes FZ-1630 Adaptor.

* Grip Puller model number without hydraulics.

** Puller capacity at 7,850 psi

▼ Shown: Cross-Bearing Puller Set BHP-361G



BHP Series

Capacity:

7, 12, 18 and 25 tons

Maximum Reach:

14.06-34.00 inches

Maximum Spread Range:

10.24-22.83 inches

Maximum Operating Pressure:

5000 psi



WARNING!

Not all puller components and configurations are rated at the set capacity. Please contact Enerpac for specific details.

- Precise hydraulic control allows fast, efficient and safe pulling
- High quality, forged steel components provide superior reliability and service
- The Cross-Bearing Puller without hydraulics, Bearing Cup Puller and Bearing Puller may be ordered separately. See items 20, 30 and 40.

▼ SELECTION CHART

Cross-Bearing Puller Set Capacity		7 ton	12 ton	18 ton	25 ton
	Model Number ►	BHP-162 ¹⁾	BHP-261G	BHP-361G	BHP-561G
Included Hydraulics:	set weight ►	57 lbs	137 lbs	267 lbs	408 lbs
Hand Pump		P-142	P-392	P-392	P-80
Cylinder		RWH-121	RCH-202	RCH-302	RCH-603
Saddle		–	HP-2015	HP-3015	HP-5016
Hose		HB-7206QB	HC-7206	HC-7206	HC-7206
Gauge		GF-120P	GF-813P	GF-813P	GF-813P
Gauge Adaptor		GA-4	GA-3	GA-3	GA-3
20 Cross-Bearing Puller	Model Number ►	BHP-1772	BHP-262	BHP-362	BHP-562
Spread (in)	Maximum	10.24	13.58	17.32	22.83
	Minimum	4.53	5.51	7.09	8.66
Reach (in)	Maximum	14.06	22.44	27.95	34.00
Adjusting Screw (in)	Diameter	¾"-16 UNF	1"-8 UNC	1¼"-7 UNC	1½"-5.50 UNS
	Length	15.75	26.38	31.10	38.39
Leg (in)	Length	4.17	4.53	8.07	23.98
	Length	14.06	9.45	18.11	34.02
	Length	–	16.54	27.95	–
	Length	–	22.44	–	–
Upper Leg Ends (in)	Thread	¾"-16 UNF	¾"-16 UNF	1"-14 UNS	1¼"-12 UNF
Lower Leg Ends (in)	Thread	⅝"-18 UNF	⅝"-18 UNF	1"-14 UNS	1¼"-12 UNF
30 Bearing Cup Puller	Model Number ►	BHP-180	BHP-280	BHP-380	BHP-580
40 Bearing Separator	Model Number ►	BHP-181	BHP-282	BHP-382	BHP-582
Wooden Case	Model Number ►	CW-166	CW-166	CW-550	CW-750

¹⁾ Includes FZ-1630 Adaptor.

Bearing Cup Pullers and Bearing Separators

▼ Shown: **BHP-180**



Bearing Cup Puller

- Made of high strength steel alloy
- Easily adapted to Cross Bearing Pullers for fast and efficient removal of the most difficult parts
- Adjustable to fit a variety of bearings and seals

BHP Series

Capacity:

7, 12, 18 and 25 tons

Maximum Reach:

4.53-5.91 inches

Maximum Spread Range:

5.71-9.45 inches

Maximum Operating Pressure:

5000 psi

▼ SELECTION CHART

Capacity*		7 ton	12 ton	18 ton	25 ton
30	Bearing Cup Puller				
	Model Number ▶	BHP-180	BHP-280	BHP-380	BHP-580
Spread (in)	Max.	5.71	6.30	9.45	9.45
	Min.	1.57	1.26	2.36	2.36
Reach (in)	Max.	4.53	5.51	5.91	5.91
	Center Screw Thread	3/4"-16 UNF	1"-8 UNC	1 1/4"-7 UNC	1 5/8"-5.50 UNS

* Bearing cup puller rated at 50% of puller capacity.



WARNING!

Do not exceed 50% of the rated puller capacity when using a double crosshead (2 grip arms) or when using puller legs in combination with bearing puller attachment.

▼ Shown: **BHP-181**



Bearing Separator

- Made of high strength steel alloy
- Wedge-shaped edges allow removal of the most hard-to-grip components
- Easily adapted to Cross Bearing Pullers for fast and efficient removal of the most difficult parts

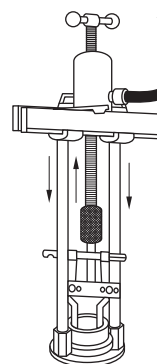

◀ Bearing Cup Puller shown with Cross Bearing Puller attachment.

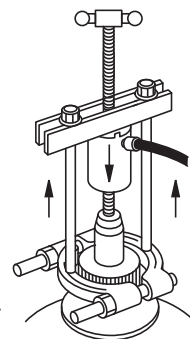

Bearing Separator shown with Cross Bearing Puller attachment. ▶

▼ SELECTION CHART

Capacity**		7 ton	12 ton	18 ton	25 ton
40	Bearing Separator				
	Model Number ▶	BHP-181	BHP-282	BHP-382	BHP-582
Spread (in)	Max.	4.33	5.28	9.84	9.84
	Min.	0.39	0.47	0.67	0.67
Width (in)		4.33	6.10	10.24	10.24
Thread		5/8"-18 UNF	5/8"-18 UNF	1"-14 UNS	1 1/4"-12 UNF

* Bearing separator rated at 50% of puller capacity.



Bearing Separator

Bearing Separator has wedge shaped edges for placing puller behind hard to reach bearings, gears, etc., where clearance prevents direct application of grip puller arms.

The Bearing Separator should be used with the Cross Bearing Puller.

OVERVIEW

The Enerpac Sync Grip multi-purpose puller range is designed to make your jobs easier and safer to accomplish.

Remove bearings, bushings, gears, sleeves, wheels and flywheels, sprockets and other shaft mounted items simply and effectively.

Mechanical and hydraulic configurations are available with a variety of optional accessories that expand application range and increase utility.

Hydraulic models are available in standard sets which include detachable hydraulic cylinders and a choice of pump options, along with a gauge assembly and hose for safe monitoring of applied pulling forces.

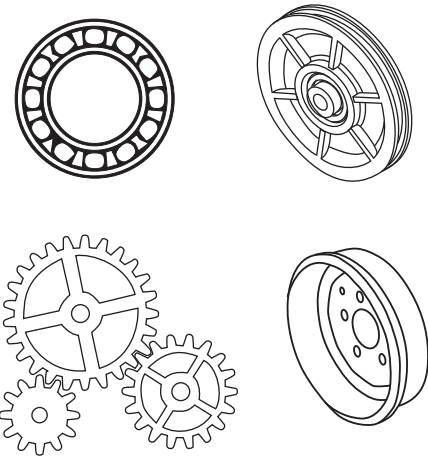

Always wear safety goggles and gloves while using pullers.



WARNING!
Do not exceed 50% of the rated puller capacity when using two jaw configurations.

▼ DIMENSIONAL DATA

Puller Capacity (ton)	Puller Model No.	Sync Grip Pullers Dimensions (in)								Wt.*** (lbs)
		Standard Reach Jaws		Optional Extended Reach Jaws		Jaw Tip			Jaw Hole Spacing	
		Max. Reach	Max. Spread	Max. Reach	Max. Spread	Height	Width	Thickness	(in)	
		A	B	A	B	D	E	F		
Mechanical Pullers										
1	SGM01*	4.13	4.33	—	—	0.31	0.28	0.30	0.75	1.8
4	SGM04*	7.28	6.89	—	—	0.30	0.31	0.83	2.01	4.4
7	SGM07*	8.86	9.45	—	—	0.39	0.31	0.98	1.75	14.3
10	SGM10*	16.14	13.78	19.29	15.94	0.49	0.59	0.98	3.27	32.0
20	SGM20	23.62	26.77	25.20	28.35	0.87	0.94	1.61	4.92	122.3
Hydraulic Pullers										
14	SGH14*	12.60	13.78	15.75	15.94	0.49	0.59	0.98	3.27	55.1
24	SGH24	12.60	18.90	17.13	21.26	0.61	0.69	1.22	4.53	108.0
36	SGH36	16.14	25.59	20.67	28.35	0.87	0.94	1.61	4.92	165.3
50**	SGH64	27.56	38.58	33.46	42.52	1.18	1.06	1.97	5.91	363.7

* Puller can be set up as a 2 or 3 jaw configuration.

** Puller capacity at 7,850 psi, maximum cylinder capacity @ 10,000 psi is 64.6 tons.

*** With standard legs and cylinder for hydraulic models



Sync Grip Pullers: available in both mechanical or hydraulic versions. Some models can be configured as a two jaw puller, however, three jaws are recommended for most even distribution of pulling forces.



Cross Puller: hydraulically powered via detachable cylinder and choice of pump. The Cross Puller can be used individually as a 'push' puller or in conjunction with the Bearing Separator or Bearing Cup Puller.



Bearing Separator: use where access is restricted. The Bearing Separator is used in conjunction with the Cross Puller.



Bearing Cup Puller: specifically designed for cup style bearing and other applications requiring an internal style puller.



Detachable Hollow Cylinder: provided with all hydraulic puller models including both the standard Sync Grip and Cross Puller.



In Sync Grip, Cross Bearing and Master Puller Sets a hose and gauge are provided as standard along with your choice of pump including manual hand operated, cordless battery powered, electric or air powered. In each case the pump selection has been optimized for compatibility with the pullers.



Easy To Use

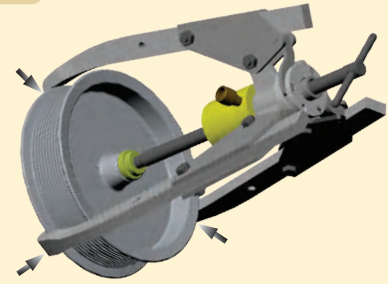

Simple, Safe, Productive

All three jaws close simultaneously making the puller easier and safer to operate.

The synchronous feature of the SGM and SGH-Series Pullers makes positioning the puller simple and helps prevent misalignment.

▼ DIMENSIONAL DATA

Cross Puller Dimensions (in)			Wt.**
Standard Leg Height	Long Leg Height	Maximum Spread	(lbs)
A	A	B	
Mechanical Pullers			
—	—	—	—
—	—	—	—
—	—	—	—
—	—	—	—
—	—	—	—
Hydraulic Pullers			
4.17	14.06	10.24	40.77
4.53	22.44	13.58	76.04
8.07	27.95	17.32	123.42
23.97	34.01	22.83	250.15

Bearing Separator Dims. (in)				Wt.
Dia.	Spread Range		Thread Size	(lbs)
A	Min. Spread	Max. Spread	C	
A	B	B		
Mechanical Pullers				
—	—	—	—	—
—	—	—	—	—
—	—	—	—	—
—	—	—	—	—
—	—	—	—	—
Hydraulic Pullers				
4.33	0.39	4.33	5/8" - 18 UNF	6.0
6.10	0.47	5.28	5/8" - 18 UNF	12.6
10.24	0.67	9.84	1" - 14 UNS	62.8
10.24	0.67	9.84	1-1/4" - 12 UNF	62.8

Bearing Cup Dimensions (in)							Wt.
Spread Range				Jaw Tip			(lbs)
Height	Height	Min. Spread	Max. Spread	Height	Width	Thickness	
A	B	C	C	D	E	F	
Mechanical Pullers							
—	—	—	—	—	—	—	—
—	—	—	—	—	—	—	—
—	—	—	—	—	—	—	—
—	—	—	—	—	—	—	—
—	—	—	—	—	—	—	—
Hydraulic Pullers							
4.53	9.33	1.57	5.71	0.20	0.18	1.22	4.41
5.51	10.47	1.26	6.30	0.18	0.18	0.98	5.29
5.91	12.20	2.36	9.45	0.31	0.43	2.17	13.22
5.91	12.20	2.36	9.45	0.31	0.43	2.17	14.11

** With cylinder and standard legs

▼ Shown: SGM10 with three jaws



SGM Series

Puller Capacity:

1-20 tons

Maximum Reach:

4.1-23.6 inches

Maximum Spread:

4.3-26.8 inches

- Sync Grip mechanism synchronizes movement of all jaws for simultaneous engagement, helping to prevent misalignment for safe and easy use
- Threaded spindle and jaw indexes provide adjustable reach
- Three-jaw configuration for even load distribution
- Two-jaw configuration for confined access applications available on all pullers 10 ton and below (not available on SGM20)
- High-strength forged jaws for superior reliability
- Suitable for a variety of applications including bearings, bushings, wheels, gears and pulleys



Dimensions

Dimensional information for all puller models is included in the dimensional overview table:

Page: 168



WARNING!

Do not exceed 50% of the rated puller capacity when using two jaw configurations.

▼ SGM10 with two jaws.



▼ DIMENSIONAL DATA

Puller Capacity (ton)	Puller Model No.	Dimensions (in)		Weight (lbs)	Long Jaw Sets Model No.*	Dimensions (in)	
		Max. Reach A	Max. Spread B			Max. Reach A	Max. Spread B
1	SGM01	4.13	4.33	1.8	—	—	—
4	SGM04	7.28	6.89	4.4	—	—	—
7	SGM07	8.86	9.45	14.3	—	—	—
10	SGM10	16.14	13.78	32.0	SG1002K	19.29	15.94
20	SGM20	23.62	26.77	122.3	SG3002K	25.20	28.35

* Jaw sets include three jaws.

Hydraulic Sync Grip Master Puller Sets

▼ Shown: **MPS14H**



MPS Series

Puller Capacity:

14-50 tons

Maximum Reach:

12.6-27.6 inches

Maximum Spread:

13.8-38.6 inches

Maximum Operating Pressure:

10,000 psi

- Sync Grip mechanism synchronizes movement of all jaws for simultaneous engagement
- Hydraulically applied pulling force increases pulling capacity reducing operator fatigue
- Standard jaws adjust to accommodate different reach requirements. Optional long jaw sets available for additional reach requirements
- Designed for applications including pulling, pushing and dismantling gears, bearings, bushings, etc.



Dimensions

Dimensional information for all puller models is included in the dimensional overview table:

Page: 168



Sets Include:¹⁾

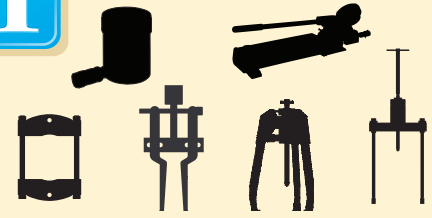

¹⁾ Choose pump options below.

▼ DIMENSIONAL DATA

Puller Capacity (ton)	Model No. (Puller and Cylinder)	Stroke (in)	Dimensions (in)		Wt. (lbs)	Hydraulic Puller Sets					Long Jaw Sets Model No. ^{***}	Dimensions (in)	
			Max. Reach A	Max. Spread B		Hand Pump	Air Pump	Electric Pump	Cordless Pump	All Sets Include:		Max. Reach A	Max. Spread B
14	SGH14	1.0	12.60	13.78	55.1	MPS14H	MPS14A	MPS14E	MPS14C	*	SG1002K	15.75	15.94
24	SGH24	2.0	12.60	18.90	108.0	MPS24H	MPS24A	MPS24E	MPS24C	GA45GC	SG2002K	17.13	21.26
36	SGH36	2.5	16.14	25.59	165.3	MPS36H	MPS36A	MPS36E	MPS36C	&	SG3002K	20.67	28.35
50**	SGH64	3.0	27.56	38.58	363.7	MPS64H	MPS64A	MPS64E	MPS64C	HC7206C	SG6002K	33.46	42.52

* 14-ton sets include an AR-630 female coupler, GA45 gauge adaptor, and G2535L gauge.

** Puller capacity at 7,850 psi, maximum cylinder capacity @ 10,000 psi is 64.6 tons.

*** Jaw sets include three jaws.

For 115 V application add "B" suffix
For 230 V application add "E" suffix

Hydraulic Sync Grip Puller Sets

▼ Shown: **GPS14H**



GPS Series

Puller Capacity:

14-50 tons

Maximum Reach:

12.6-27.6 inches

Maximum Spread:

13.8-38.6 inches

Maximum Operating Pressure:

10,000 psi

- Sync Grip mechanism synchronizes movement of all jaws for simultaneous engagement
- Hydraulically applied pulling force increases pulling capacity and reduces operator fatigue
- Threaded spindle and jaw indexes provide adjustable reach
- Three-jaw configuration for even load distribution
- High-strength forged jaws for superior reliability
- The versatile puller set facilitates safe and easy dismantling in a variety of applications



Dimensions

Dimensional information for all puller models is included in the dimensional overview table:

Page: 168



Sets Include:¹⁾



¹⁾ Choose pump options below.

▼ DIMENSIONAL DATA

Puller Capacity (ton)	Model No. (Puller and Cylinder)	Stroke (in)	Dimensions (in)		Wt. (lbs)	Hydraulic Puller Sets					Long Jaw Sets Model No. ^{***}	Dimensions (in)	
			Max. Reach A	Max. Spread B		Hand Pump	Air Pump	Electric Pump	Cordless Pump	All Sets Include:		Max. Reach A	Max. Spread B
14	SGH14	1.0	12.60	13.78	55.1	GPS14H	GPS14A	GPS14E	GPS14C	*	SG1002K	15.75	15.94
24	SGH24	2.0	12.60	18.90	108.0	GPS24H	GPS24A	GPS24E	GPS24C	GA45GC	SG2002K	17.13	21.26
36	SGH36	2.5	16.14	25.59	165.3	GPS36H	GPS36A	GPS36E	GPS36C	&	SG3002K	20.67	28.35
50**	SGH64	3.0	27.56	38.58	363.7	GPS64H	GPS64A	GPS64E	GPS64C	HC7206C	SG6002K	33.46	42.52

* 14-ton sets include an AR-630 female coupler, GA45 gauge adaptor, and G2535L gauge.

** Puller capacity at 7,850 psi, maximum cylinder capacity @ 10,000 psi is 64.6 tons.

*** Jaw sets include three jaws.

For 115 V application add "B" suffix
For 230 V application add "E" suffix

Cross-Bearing Puller Sets

▼ Shown: Cross-Bearing Puller Set BHP361G



- Precise hydraulic control allows fast, efficient and safe pulling
- High-quality forged components provide superior reliability and service
- Quick set-up to tackle a variety of jobs

BHP Series

Puller Capacity:
7-25 tons

Maximum Reach:
14.1-34 inches

Maximum Spread:
10.2-22.8 inches

Maximum Operating Pressure:
10,000 psi



WARNING!
Enerpac cylinder and pump can be operated to 10,150 psi, but should not be operated past 5,075 psi when using the cross bearing puller set tools.



Dimensions
Dimensional information for all puller models is included in the dimensional overview table:

Page: 168



Sets Include:¹⁾

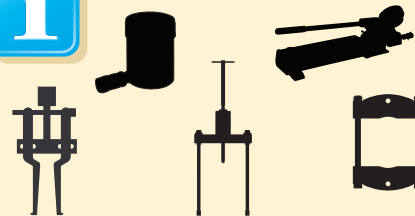

¹⁾ Choose pump options below.

▼ DIMENSIONAL DATA

Puller Capacity* (ton)	Cross-Bearing Only Model No.	Stroke (in)	Dimensions (in)		Cross Bearing Puller Sets			
			Maximum Reach A	Maximum Spread B	Hand Pump	Air Pump	Electric Pump	Cordless Pump
7	BHP1772	1.0	14.06	10.24	BHP162	BHP162A	BHP162E	BHP162C
12	BHP262	2.0	22.44	13.58	BHP261G	BHP261GA	BHP261GE	BHP261GC
18	BHP362	2.5	27.95	17.32	BHP361G	BHP361GA	BHP361GE	BHP361GC
25	BHP562	3.0	34.01	22.83	BHP561G	BHP561GA	BHP561GE	BHP561GC

* Cross Puller, Bearing Cup Puller and Bearing Separator rated at 50% of Grip Puller capacity.

For 115 V application add "B" suffix
For 230 V application add "E" suffix

▼ Shown from left to right: EP-206, EP-108



For Safer and Faster Pulling

- Patented “Safety Cage” jaw retention system
- Roll threaded shafts for less effort when applying high torque
- Slim tapered jaws for improved gripping in tight spots
- Available in 2 and 3 jaw design and inside and outside pulling configuration
- More efficient pulling, as one man can do the job where manual pullers often require two operators



Long Jaws

Long Jaws are used to increase the reach and spread of manual pullers. They maintain the same pulling capacity as the standard jaws, but reduces clamping force by 25%.

Page: 177



Shaft Attachments

Shaft protectors and extenders are live centers that fit over the standard puller shaft for tip protection and additional reach.

Page: 177



Application Tip

Because of the unique Safety Cage design, Posi Lock® pullers will grip on surfaces where normal pullers would slip off; e.g. tapered bearings.



◀ Positioning an EP-104, 3-jaw puller on the drive pulley of an electric motor.

Posi Lock® Mechanical Grip Pullers

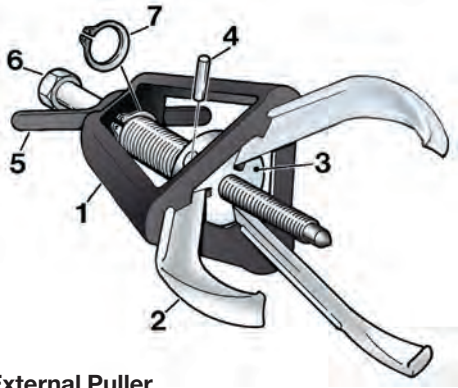

External Puller

- 1 Patented "Safety Cage" guides jaws, holding them securely onto the part.
- 2 Durable forged jaws provide positive grip.
- 3 Jaw head provides pivot and reaction point for jaws.
- 4 Pin, for easy jaw removal and replacement.
- 5 T-handle provides control of the puller jaws.
- 6 Drive bolt with rolled threads for increased force with reduced input torque.
- 7 Snap-ring retains cage to drive bolt and provides quick removal for easy service.

EP EPP Series



Capacity:
2-40 tons

Maximum Reach:
4.00-14.00 inches

Spread Range:
0.50-25.00 inches

▼ QUICK SELECTION CHART EXTERNAL PULLERS

For full technical information see next page.

Number of Jaws	Maximum Reach (in)	Spread Range (in)	Capacity (tons)	Model Number	Center Bolt Diameter (in)	Weight (lbs)
2	4.00	.5-5	2	EP-204	.56	3
3	4.00	.5-5	5	EP-104	.56	4
2	6.00	.5-7.0	6	EP-206	.66	7
3	6.00	.5-7.0	10	EP-106	.66	8
2	8.00	.75-12	12	EP-208	.79	12
3	8.00	.75-12	17	EP-108	.79	14
2	9.67	1.0-15	14	EP-210	.79	13
3	9.67	1.0-15	20	EP-110	.79	16
2	12.00	2.5-18	25	EP-213	1.17	38
3	12.00	2.5-18	30	EP-113	1.17	44
2	14.00	3.0-25	35	EP-216	1.23	57
3	14.00	3.0-25	40	EP-116	1.23	68



Always wear Safety Goggles and Gloves while using pullers.



Application Tip

In determining the correct manual puller capacity for your application, use the following rule:

The center bolt diameter of the puller should be at least 1/2 the diameter of the shaft being pulled on.

Example:

A part being pulled from a shaft with a diameter of 1.5" would require a puller with a center bolt diameter of at least .75".

Internal Puller

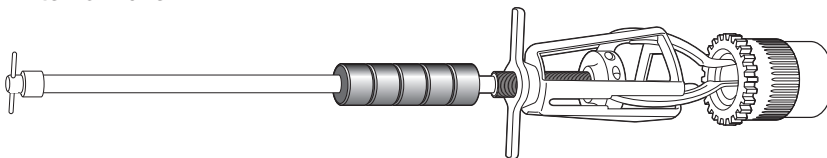

▼ QUICK SELECTION CHART INTERNAL PULLERS

For full technical information see next page.

Number of Jaws	Maximum Reach (in)	Spread Range (in)	Jaw Style	Model Number	Jaw Length (in)	Weight (lbs)
3	5.87	.56-4.00	Standard	EPPMI-6	6.62	8.6
	7.70	1.0-5.25	Long		8.62	8.6

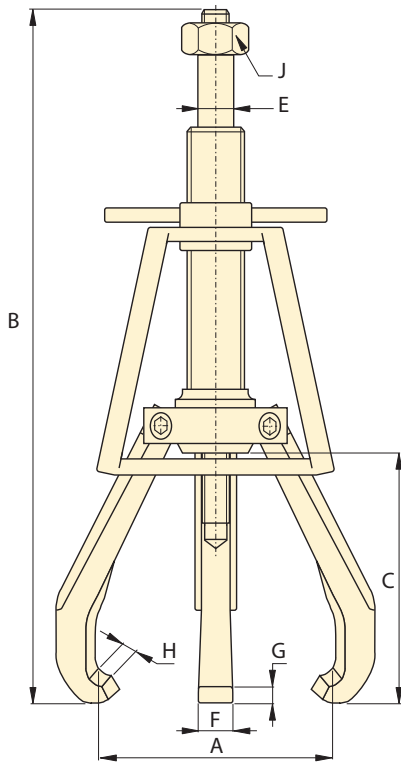

**2- and 3-Jaw External Puller
EP-Series**



▲ EP-204 2-jaw puller positioned to pull a water pump drive pulley.

▼ SELECTION CHART EXTERNAL PULLERS

Number of Jaws	Maximum Reach (in)	Spread Range (in)	Capacity (tons)	Model Number	Center Bolt Diameter (in)	Maximum Torque (ft.lb)
2	4.00	.5-5.0	2	EP-204	.56	20
3	4.00	.5-5.0	5	EP-104	.56	40
2	6.00	.5-7.0	6	EP-206	.66	75
3	6.00	.5-7.0	10	EP-106	.66	130
2	8.00	.75-12.0	12	EP-208	.79	150
3	8.00	.75-12.0	17	EP-108	.79	220
2	9.67	1.0-15.0	14	EP-210	.79	175
3	9.67	1.0-15.0	20	EP-110	.79	275
2	12.00	2.5-18.0	25	EP-213	1.17	475
3	12.00	2.5-18.0	30	EP-113	1.17	600
2	14.00	3.0-25.0	35	EP-216	1.23	800
3	14.00	3.0-25.0	40	EP-116	1.23	850

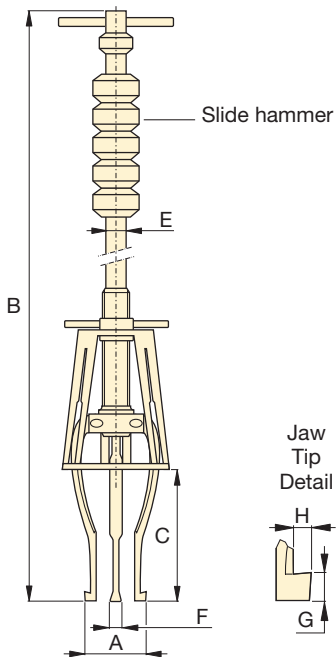

Internal Puller EPPMI-Series

▼ SELECTION CHART INTERNAL PULLERS

Number of Jaws	Maximum Reach (in)	Spread Range (in)	Jaw Style	Model Number	Jaw Length (in)	Slide-hammer Weight (lbs)
3	5.87	.56-4.00	Standard	EPPMI-6	6.62	2.5
	7.70	1.00-5.25	Long		8.62	2.5

Posi Lock® Mechanical Grip Pullers



Shaft Protectors and Extenders

Shaft Protectors and Extenders are live centers that fit over the puller end for tip protection and added reach.

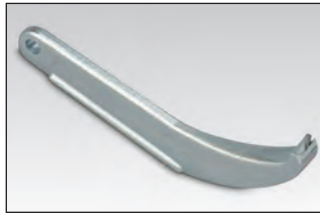

Long Jaws

Long Jaws are used to increase the reach and spread of manual pullers. They maintain the same pulling capacity as the standard jaws, but reduces clamping force by 25%.

EP EPP Series



Capacity:

2-40 tons

Maximum Reach:

4.00-14.00 inches

Spread Range:

0.50-25.00 inches

Length (in)	Diameter (in)	Increases Center Bolt Length (in)	Order: Model Number
1.00	0.75	0.38	EPP-4
1.97	0.75	1.50	EPX-4
1.22	0.87	0.50	EPP-6
1.97	0.87	1.50	EPX-6
1.22	1.00	0.50	EPP-10
1.97	1.00	1.50	EPX-10
2.00	1.38	0.83	EPP-1316

Note: See the chart below to reference matching pullers for these accessories.

Spread (in)	Reach (in)	Order: Model Number
1.5-15	9.67	EP-11054
1.5-22	15.78	EP-11054L
1.5-30	20	EP-11354L
1.0-5.26	8.62	EP-10554L*

* EPPMI-6 only

Dimensions								Model Number	Optional Accessories		
Spread Range	Overall Length	Maximum Reach	Center Bolt Diameter	Jaw Width	Tip Clearance	Tip Depth	Hex Socket Size				
A	B	C	E	F	G	H	J		Shaft Protectors	Extenders	Long Jaws
.5-5.0	9.68-12.75	4.00	.56	.54	.16	.18	7/8	EP-204	EPP-4	EPX-4	-
.5-5.0	9.68-12.75	4.00	.56	.54	.16	.18	7/8	EP-104	EPP-4	EPX-4	-
.5-7.0	12.75-18.75	6.00	.66	.75	.32	.24	1 1/16	EP-206	EPP-6	EPX-6	-
.5-7.0	12.75-18.75	6.00	.66	.75	.32	.24	1 1/16	EP-106	EPP-6	EPX-6	-
.75-12.0	16.25-24.25	8.00	.79	.77	.25	.36	1 1/4	EP-208	EPP-10	EPX-10	EP-11054
.75-12.0	16.25-24.25	8.00	.79	.77	.25	.36	1 1/4	EP-108	EPP-10	EPX-10	EP-11054
1.0-15.0	19.25-29.00	9.67	.79	.77	.25	.36	1 1/4	EP-210	EPP-10	EPX-10	EP-11054L
1.0-15.0	19.25-29.00	9.67	.79	.77	.25	.36	1 1/4	EP-110	EPP-10	EPX-10	EP-11054L
2.5-18.0	26.00-38.00	12.00	1.17	1.25	.50	.38	1 11/16	EP-213	EPP-1316	-	EP-11354L
2.5-18.0	26.00-38.00	12.00	1.17	1.25	.50	.38	1 11/16	EP-113	EPP-1316	-	EP-11354L
3.0-25.0	31.50-45.50	14.00	1.23	1.44	.53	.46	1 13/16	EP-216	EPP-1316	-	-
3.0-25.0	31.50-45.50	14.00	1.23	1.44	.53	.46	1 13/16	EP-116	EPP-1316	-	-

Note: Overall length (B) is dependent on position of center bolt.

Dimensions (in)							Model Number
Spread Range	Overall Length	Maximum Reach	Slide Rod Diameter	Jaw Width	Tip Clearance	Tip Depth	
A	B	C	E	F	G	H	
.56-4.00	29.00	5.87	.52	.33	.12	.06	EPPMI-6
1.00-5.25	31.00	7.70	.52	.33	.30	.18	



Always wear Safety Goggles and Gloves while using pullers.

▼ Shown: EPHR-110



- Patented “Safety Cage” jaw retention system
- High force hydraulic system for effortless pulling of large components
- Slim tapered jaws for better gripping in tight spots
- Available in 2 and 3 jaw design
- More efficient pulling, as one man can do the job where normal pullers often require two operators

High-Tech Pulling



Transport and Store

Conveniently store and transport hydraulic pullers and accessories. Order the **EPT-2550** Storage Cart and make your job easier to do!



Long Jaws

Long Jaws are used to increase the reach and spread of hydraulic pullers. They maintain the same pulling capacity as the standard jaws, but reduces clamping force by 25%.

Page: 180



Application Tip

Because of the unique safety cage design, Posi Lock® pullers will grip on surfaces where normal pullers would slip off; e.g. tapered bearings.

▼ An EPH-113 hydraulic Posi Lock® puller easily removes machined parts from a heavy-production press.

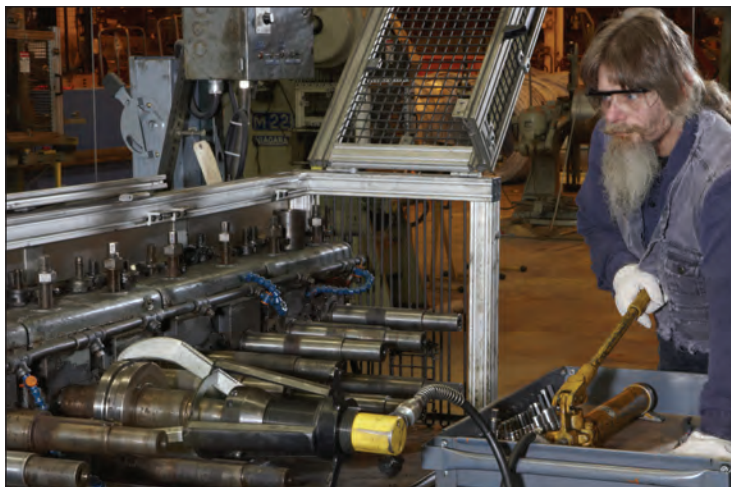

Basic Pullers only, cylinder not included.

Number of Jaws	Maximum Spread	Spread Range	Capacity	Model Number*
	(in)	(in)		
2	12.00	.75-12.0	10	EPH-208
3	12.00	.75-12.0		EPH-108
2	15.00	1.0-15.0	15	EPH-210
3	15.00	1.0-15.0		EPH-110
2	18.00	2.5-18.0	25	EPH-213
3	18.00	2.5-18.0		EPH-113
2	25.00	3.0-25.0	50	EPH-216
3	25.00	3.0-25.0		EPH-116

*Cylinder is not included.

Posi Lock® Hydraulic Grip Pullers

▼ SETS SELECTION CHART

Style	Capacity (ton)	Basic Puller	Cylinder	Stroke (in)	Pump Set	Set Model Number	Weight (lbs)
2 Jaw Puller	10	EPH-208	RC-106	6	-	EPHR208	24
	10	EPH-208	RC-106	6	EP-1	EPHS208	60
	15	EPH-210	RC-1510	10	-	EPHR210	49
	15	EPH-210	RC-1510	10	EP-1	EPHS210	85
	25	EPH-213	RC-2514	14.25	-	EPHR213	98
	25	EPH-213	RC-2514	14.25	EP-1	EPHS213	118
	50	EPH-216	RC-5013	13.25	-	EPHR216	192
	50	EPH-216	RC-5013	13.25	EP-2	EPHS216	212
3 Jaw Puller	10	EPH-108	RC-106	6	-	EPHR108	26
	10	EPH-108	RC-106	6	EP-1	EPHS108	62
	15	EPH-110	RC-1510	10	-	EPHR110	52
	15	EPH-110	RC-1510	10	EP-1	EPHS110	88
	25	EPH-113	RC-2514	14.25	-	EPHR113	106
	25	EPH-113	RC-2514	14.25	EP-1	EPHS113	126
	50	EPH-116	RC-5013	13.25	-	EPHR116	202
	50	EPH-116	RC-5013	13.25	EP-2	EPHS116	222

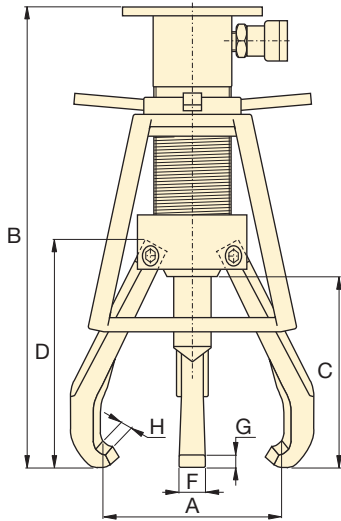

EPH Series



Capacity:

10-50 tons

Maximum Reach:

8.0-14.0 inches

Spread Range:

0.75-25.0 inches

Maximum Operating Pressure:

10,000 psi



Pump Sets

All Posi Lock Hydraulic Puller Sets that include 115 VAC pumps will feature the following components:

	EP-1 Pump Set	EP-2 Pump Set
Pump	PUJ-1200B	ZE3208MB
Hose	HC-9210	HC-9210
Gauge	G-2535L	G-2535L
Adapter	N/A	GA-3

Components for 230 VAC pumps are available on request.

▼ *Optional Accessory

Dimensions (in)							Weight (lbs)	Model Number	Ram Point Sets	Lift Plates	*Long Jaws
Spread Range	Overall Length	Max. Reach	Jaw Length	Jaw Width	Tip Clearance	Tip Depth					
A	B	C	D	F	G	H					
.75-12.0	19.61	8.00	9.34	.88	.29	.27	14	EPH-208	EPH-155	EPH-11052	EP-11054
.75-12.0	19.61	8.00	9.34	.88	.29	.27	16	EPH-108	EPH-155	EPH-11052	EP-11054
1.0-15.0	26.19	10.00	10.64	1.00	.441	.36	22	EPH-210	EPH-155	EPH-11052	EPH-11054L
1.0-15.0	26.19	10.00	10.64	1.00	.441	.36	25	EPH-110	EPH-155	EPH-11052	EPH-11054L
2.5-18.0	33.31	12.00	13.72	1.25	.508	.38	47	EPH-213	EPH-257	EPH-11352	EPH-11354L
2.5-18.0	33.31	12.00	13.72	1.25	.508	.38	55	EPH-113	EPH-257	EPH-11352	EPH-11354L
3.0-25.0	36.19	14.00	16.29	1.44	.598	.46	90	EPH-216	EPH-508	EPH-11652	-
3.0-25.0	36.19	14.00	16.29	1.44	.598	.46	100	EPH-116	EPH-508	EPH-11652	-

For full details on puller accessories see page 170.

* Long Jaws are available as optional accessories.

EPH Series



Capacity:
10-50 tons

Maximum Reach:
9.7-20.0 inches



Spread Range:
1.5-30.0 inches



IMPORTANT!

Always wear Safety Goggles and Gloves while using pullers.

▼ RAM POINT SETS SELECTION CHART

Fits Model Number	EPH-208 EPH-108 EPH-210 EPH-110	EPH-213 EPH-113	EPH-216 EPH-116
			
Set Number	EPH-155	EPH-257	EPH-508
Set Includes	Dia. x Length (in)	Dia. x Length (in)	Dia. x Length (in)
Flat Ram Point	1 x 1	1.5 x 2.25	2 x 3
	1 x 3	2 x 2.25	2.75 x 3
	–	2 x 4	2.75 x 5
Tapered Ram Point	1 x 1.5	1.5 x 2.5	2 x 3.75
	1 x 3.5	2 x 2.5	2 x 3.75
	–	2 x 4.5	2.75 x 5.5
Ram Point Adaptor	–	–	2.75 x 2.25

▼ LIFT PLATE SELECTION CHART

Fits Puller Set Model Number	Model Number *	Thickness (in)	Diameter (in)
EPH-208	EPH-11052	.25	6
EPH-108	EPH-11052	.25	6
EPH-210	EPH-11052	.25	6
EPH-110	EPH-11052	.25	6
EPH-213	EPH-11352	.38	8
EPH-113	EPH-11352	.38	8
EPH-216	EPH-11652	.38	10
EPH-116	EPH-11652	.38	10



* Mounting screws included. Lifting plates are standard included with EPH-Series Pullers.

▼ LONG JAW SELECTION CHART

Fits Puller Set Model Number	Model Number	No. of Jaws Required	Spread Range (in)	Max. Reach (in)	Wt. (each) (lbs)
EPH-208	EP-11054	2	2.25 - 15.0	9.7	2.5
EPH-108		3			
EPH-210	EPH-11054L	2	1.5 - 22.0	15.8	5.5
EPH-110		3			
EPH-213	EPH-11354L	2	1.5 - 30.0	20.0	10.5
EPH-113		3			



◀ EPH-11054L

Long Jaws are used to increase the reach and spread of hydraulic pullers. They maintain the same pulling capacity as the standard jaws, but reduces clamping force by 25%.

Posi Lock® 100-Ton Hydraulic Grip Pullers

▼ EPH-1003



- Roller cart with power lift
- Adjustable jaw tips
- Puller easily detaches from cart
- Self-contained unit
- Puller height range 26.5" to 66.5"

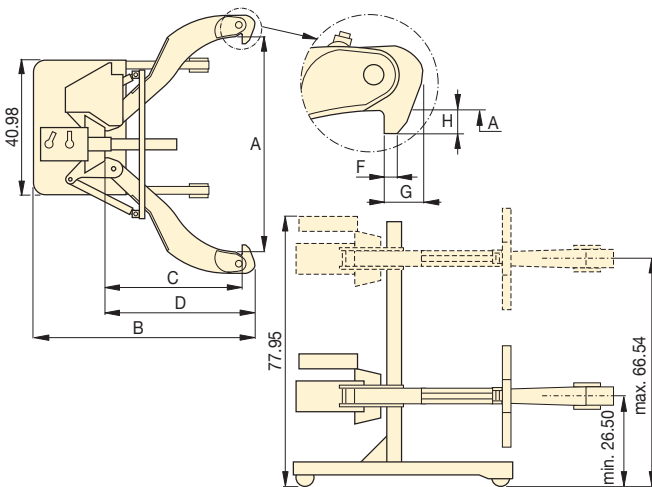

EPH Series

Capacity:
100 tons

Maximum Reach:
48 inches

Spread Range:
7.5 - 70 inches

Maximum Operating Pressure:
10,000 psi

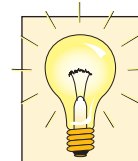

Pushing Adaptors

All Posi Lock 100 Ton Hydraulic Pullers include (3) pushing adaptors.

Diameter (in)	Overall Length (in)	Model Number
3.5	29	EPHT-1162
3.5	19	EPHT-1163
3.5	9	EPHT-1164



▲ The EPH-1002 quickly and easily removes this drive coupler from its shaft.

Number of Jaws	Max. Spread (in)	Capacity (tons)	Model Number	Dimensions (in)							Weight (lbs)
				Spread Range	Overall Length	Reach (max.)	Jaw Length	Jaw Width	Tip Clearance	Tip Depth	
				A	B	C	D	F	G	H	
2	70.00	100	EPH-1002	7.5-70.0	77.00	48.00	53.00	1.25	3.5	3.5	1700
3	70.00		EPH-1003	7.5-70.0	77.00	48.00	53.00	1.25	3.5	3.5	1950

Enerpac offers an extensive range of dedicated tools for a variety of specific and flexible applications. Whatever your requirement... cutting, punching, spreading or bending... you can be sure that Enerpac has the correct tool to do your job safely and efficiently.

Featuring maintenance sets, machine lifts and load skates, as well as hole punches, pipe benders and cable cutters, Enerpac has the tools to ensure that even your most demanding applications can be undertaken with the highest degree of safety and accuracy.

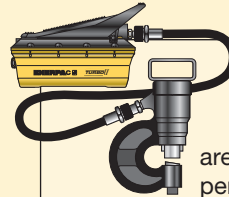

Pump and Tool Sets

Selected hydraulic tools in this section are available in sets, for a perfect tool-pump match.



Hydraulic System Set-up

Check out our "Yellow Pages" section for help on system set-ups and valving configurations.

Page: 273













Bolting Tools

More Enerpac Tools can be found in the Bolting Tools section of this catalog.

Page: 202



Capacity (tons)	Tool Type and Functions	Series		Page
2.5 - 12.5	Maintenance Sets	MS		184 ▶
35 - 50	Punch, Punch Sets	SP MSP STP		188 ▶
16	Lifting Wedge	LW		192 ▶
8.5 - 20	Hydraulic Machine Lifts	SOH		193 ▶
1-80	Heavy-Duty Load Skates	ER ES ELP		194 ▶
.67 - 16 (cubic feet)	Industrial Storage Cases	CM		196 ▶
.75 - 1.00	Hydraulic Wedgie Spread Cylinders	A WR		197 ▶
3 - 20	Hydraulic Cutterheads Cutterheads Pump Sets	WHC WHR STC		198 ▶
3 - 20	Self-Contained Hydraulic Cutters	WMC		199 ▶
Nominal Bore 1/2" - 4 inches	Pipe Bender Sets	STB		200 ▶

▼ Shown: MS2-10



The Universal Hydraulic Tool Box



Maintenance Sets

Enerpac Maintenance sets are a complete assortment of accessories matched to hydraulic powered tools. Using these sets allows you to quickly configure a unique tool to meet your most difficult jobs.

Built around the Enerpac lightweight hand pump, hose and cylinder, these sets enable you to push, pull, lift, press, straighten, spread and clamp with forces up to 12.5 tons.

- All sets include Enerpac pump, hose, cylinder and gauge
- Lock-on or threaded connectors
- Complete set for almost every maintenance application



More Information

For detailed information on all included attachments, see the following pages.

Page: 186



Clamping a workpiece is just one of the many applications for the Enerpac maintenance sets. ▶

▼ QUICK SELECTION CHART ▶

Capacity using attachments* (tons)	Set Model Number						Number of Attachment Components	Weight (lbs)
2.5	MS2-4	P-142	HC-7206	RC-55	GP-10S	GA-4	33	59
2.5	MSFP-5**	P-142	HC-7206	RC-55	G2535L	GA-3	24	44
5	MSFP-10	P-392	HC-7206	RC-106	G2535L	GA-3	23	105
5	MS2-10	P-392	HC-7206	RC-106	GP-10S	GA-2	35	140
12.5	MS2-20	P-392	HC-7206	RC-256	GP-10S	GA-2	13	210
5-12.5	MS2-1020	P-392	HC-7206	RC-102, -106, -256	GP-10S	GA-2	53	350

* If no attachments are being used, capacity is double these values. Maximum operating pressure is then 10,000 psi.

** This set also includes the FZ-1055 Adaptor.

MS-Series, Maintenance Sets



CAUTION!

When cylinders are used with maintenance set attachments or components, the maximum system pressure must be limited to half the rated pressure (5,000 psi).



WARNING!

Only use attachments provided with set. Non-Enerpac attachments and longer extension tubes will reduce column strength, potentially creating unsafe conditions.

MS Series



Capacity (using attachments):

2.5-12.5 tons

Max. Operating Pressure (using attachments):

5,000 psi

▼ APPLICATION EXAMPLES

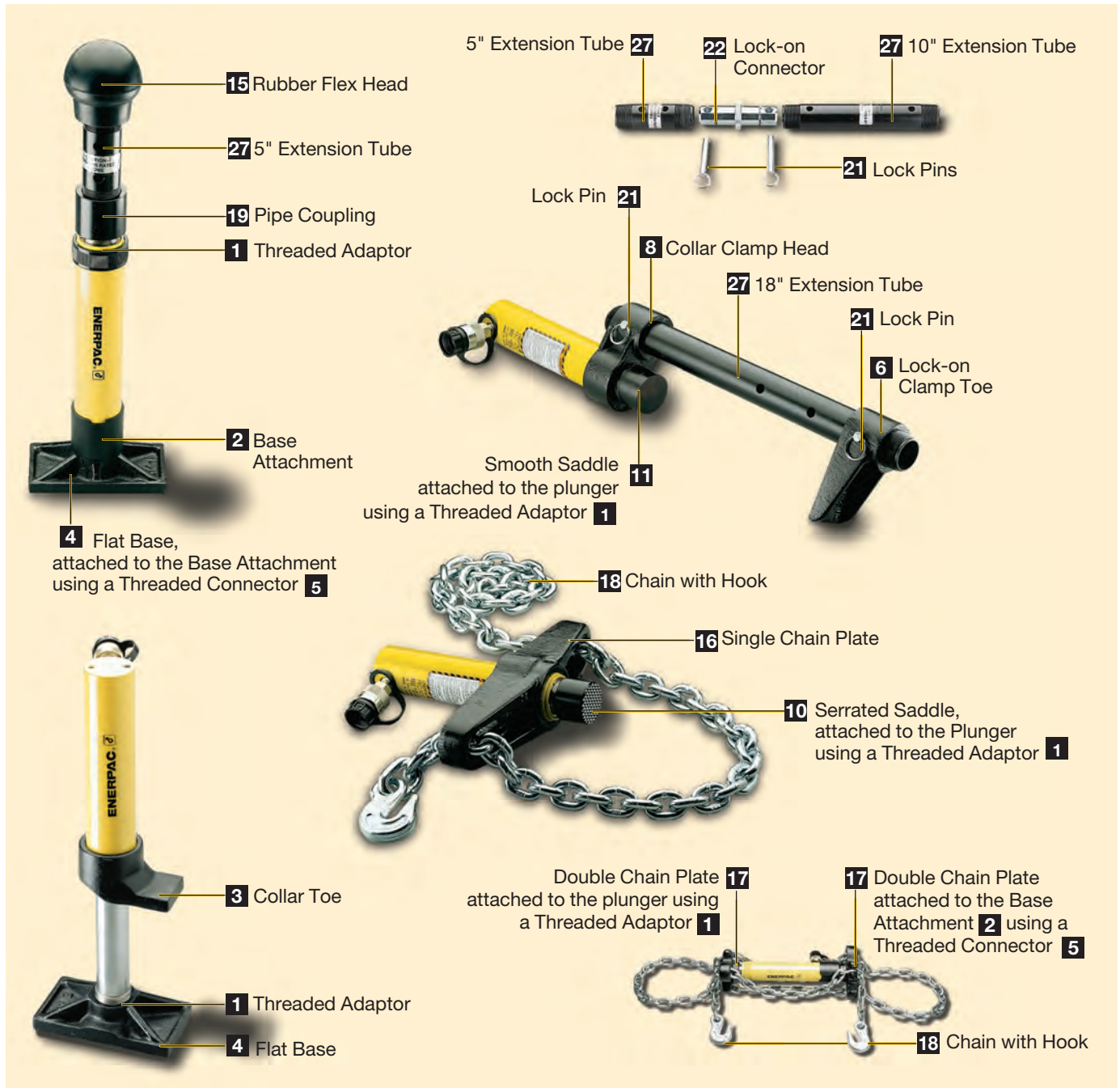

MS-Series, Maintenance Sets



CAUTION! When cylinders are used with maintenance set attachments or components, the maximum system pressure must be limited to half the rated pressure (5,000 psi).

Note: All dimensions in inches.

Set Model No.	MS2-4	MSFP-5	MSFP-10	MS2-10	MS2-20	MS2-1020
Base/Collar/ Plunger Attachments	Capacity Using Attachments					
	2.5 tons	2.5 tons	5.0 tons	5.0 tons	12.5 tons	5-12.5 tons
Cylinder Series	RC-5	RC-5	RC-10	RC-10	RC-25	RC-10, RC-25
1	A-23	A-23	A-13	A-13	A-28	A-13 / A-28
2	A-25	A-25	A-21	A-21	A-27	A-21 / A-27
3	A-1034	A-1034	A-20	A-20	A-595	A-20 / A-595
4	MZ-4010	MZ-4010	A-14	A-14	A-243	A-14 / A-243
5	A-545	A-545	A-10	A-10	—	A-10(2x)
6	—	—	—	A-8	—	A-8
7	A-530	A-530	A-6	A-6	—	A-6
8	MZ-4011	—	—	A-192	—	A-192
9	—	—	—	A-305	—	A-305
10	A-531	A-531	A-18	A-18	—	A-18
11	—	—	—	A-185	—	A-185
12	A-532	A-532	A-15	A-15	—	A-15
13	—	—	—	—	A-607	A-607
14	A-629	A-629	A-129	A-129	—	A-129
15	A-539	A-539	A-128	A-128	—	A-128
Chains and Attach- ments for Pulling	2.5 tons	2.5 tons	5.0 tons	5.0 tons	12.5 tons	5-12.5 tons
Cylinder Series	RC-5	RC-5	RC-10	RC-10	RC-25	RC-10, RC-25
16	A-558	—	—	A-132	A-238	A-132, -238
17	—	—	—	A-5 (2x)	—	A-5(2x)
18	A-557(2x)	—	—	A-141(2x)	A-218(2x)	A-141(2x) / A-218(2x)
Tubes, Connectors and Adaptors	2.5 tons	2.5 tons	5.0 tons	5.0 tons	12.5 tons	5-12.5 tons
Cylinder Series	RC-5	RC-5	RC-10	RC-10	RC-25	RC-10, RC-25
19	A-544	—	—	A-19(2x)	A-242(2x)	A-19(2x) and A-242(2x)
20	WR-5	WR-5	WR-5	A-92	—	A-92
21	MZ-4013(4x)	MZ-4013(4x)	A-16(4x)	A-16(4x)	—	A-16(4x)
22	MZ-4007(3x)	MZ-4007(3x)	MZ-1050(3x)	MZ-1050(2x)	—	MZ-1050(3x)
23	MZ-4008(2x)	—	—	MZ-1051	—	MZ-1051(2x)
24	MZ-4009	MZ-4009	MZ-1052	MZ-1052	—	MZ-1052
25	—	—	—	A-285	—	A-285
26	A-650	—	—	—	—	—
Length: 3"	MZ-4002	MZ-4002	—	—	—	—
	5"	MZ-4003	MZ-4003	MZ-1002	MZ-1002	—
	10"	MZ-4004	MZ-4004	MZ-1003	MZ-1003	A-239
						and A-239
	18"	MZ-4005(2x)	MZ-4005	MZ-1004	MZ-1004	A-240
						and A-240
	23"	MZ-4006	MZ-4006	—	—	—
	30"	—	—	MZ-1005	MZ-1005	A-241
						and A-241
Case	CM-6	CM-6	CW-166	CW-166	CW-166	CW-350
Weight	59 lbs.	44 lbs.	105 lbs.	140 lbs.	210 lbs.	350 lbs.

Base/Collar/Plunger Attachments

1 Threaded Adaptor

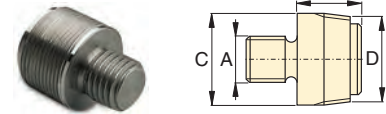

Tons	Model No.	A	B	C	D
2.5	A-23	3/4"-16 UN	1.13	1.05	3/4"-14 NPT
5.0	A-13	1"-8 UN	1.25	2.19	1 1/4"-11 1/2 NPT
12.5	A-28	1 1/2"-16 UN	1.87	2.75	2"-11 1/2 NPT

2 Base Attachment



Tons	Model No.	A	B	C	D
2.5	A-25	3/4"-14 NPT	2.00	.50	1.75
5.0	A-21	1 1/4"-11 1/2 NPT	2.25	.50	2.56
12.5	A-27	2"-11 1/2 NPT	2.50	.50	3.88

3 Collar Toe

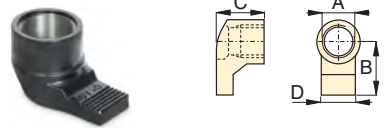

Tons	Model No.	A	B	C	D
2.5	A-1034	1 1/2"-16	2.13	1.97	1.25
5.0	A-20	2 1/4"-14	3.16	2.25	2.25
12.5	A-595	3 3/16"-12	4.06	2.03	3.18

4 Flat Base



Tons	Model No.	A	B	C	D
2.5	MZ-4010	3/4"-14 NPT	4.50	1.25	2.50
5.0	A-14	1 1/4"-11 1/2 NPT	6.50	1.38	3.50
12.5	A-243*	2"-11 1/2 NPT	6.50	2.31	6.50

* A-243 is a round base model

5 Threaded Connector

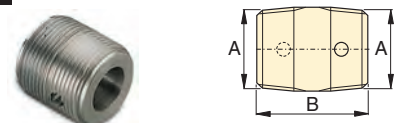

Tons	Model No.	A	B
2.5	A-545	3/4"-14 NPT	1.38
5.0	A-10	1 1/4"-11 1/2 NPT	1.63

6 Lock-on Clamp Toe



Tons	Model No.	A	B	C	D
5.0	A-8	1.69	4.13	2.00	2.25

MS-Series, Maintenance Sets

7 Threaded Plunger Toe



Tons	Model No.	A	B	C	D
2.5	A-530	3/4"-14 NPT	2.25	1.00	1.33
5.0	A-6	1 1/4"-11 1/2 NPT	3.12	1.25	2.25

8 Collar Clamp Head

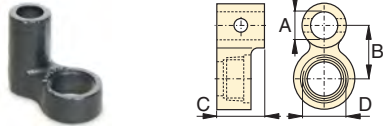

Tons	Model No.	A	B	C	D
2.5	MZ-4011	3/4"-14 NPT	1.95	3.00	1 1/2-16 UN
5.0	A-192	1.69	2.50	2.00	2 1/4-14 UN

9 Spreader Toe



Tons	Model No.	A	B	C	D
5.0	A-305	1 1/4"-11 1/2 NPT	4.50	1.00	2.00

10 Serrated Saddle

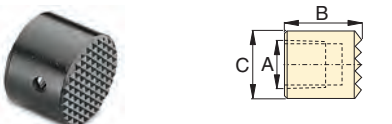

Tons	Model No.	A	B	C
2.5	A-531	3/4"-14 NPT	1.25	1.09
5.0	A-18	1 1/4"-11 1/2 NPT	2.00	1.50

11 Smooth Saddle

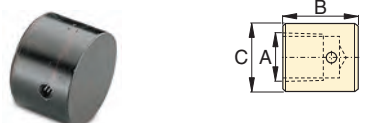

Tons	Model No.	A	B	C
5.0	A-185	1 1/4"-11 1/2 NPT	1.50	2.00

12 90° V-Base

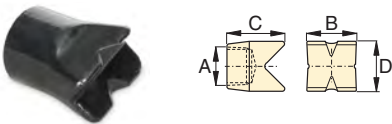

Tons	Model No.	A	B	C	D
2.5	A-532	3/4"-14 NPT	1.50	1.88	1.00
5.0	A-15	1 1/4"-11 1/2 NPT	2.13	2.25	2.13

13 Plunger Base

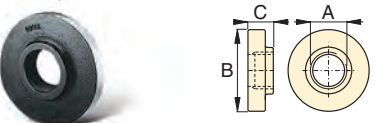

Tons	Model No.	A	B	C
12.5	A-607	2"-11 1/2 NPT	6.56	1.53

14 Wedge Head



Tons	Model No.	A	B	C	D
2.5	A-629	3/4"-14 NPT	2.75	1.31	1.13
5.0	A-129	1 1/4"-11 1/2 NPT	4.00	2.00	1.75

15 Rubber Flex-Head



Tons	Model No.	A	B	C
2.5	A-539	3/4"-14 NPT	1.75	2.75
5.0	A-128	1 1/4"-11 1/2 NPT	3.40	3.40

Chains and Attachments for Pulling

16 Single Chain Plate

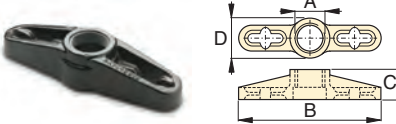

Tons	Model No.	A	B	C	D
2.5	A-558	1 1/2"-16 UN	7.75	1.56	1.75
5.0	A-132	2 1/4"-14 UN	12.12	2.50	3.12
12.5	A-238	3 5/8"-12 UN	17.75	4.03	4.93

17 Double Chain Plate

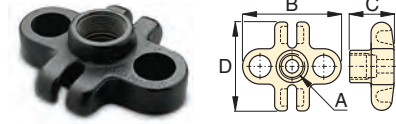

Tons	Model No.	A	B	C	D
5.0	A-5	1 1/4"-11 1/2 NPT	6.18	2.00	4.96

18 Chain with Hook



Tons	Model No.	Chain Length
2.5	A-557	5 feet
5.0	A-141	6 feet
12.5	A-218	8 feet

Tubes, Connectors and Adaptors

19 Pipe Coupling

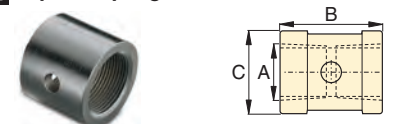

Tons	Model No.	A	B	C
2.5	A-544	3/4"-14 NPT	1.69	1.31
5.0	A-19	1 1/4"-11 1/2 NPT	1.94	2.15
12.5	A-242	2"-11 1/2 NPT	3.50	3.25

20 Spreader

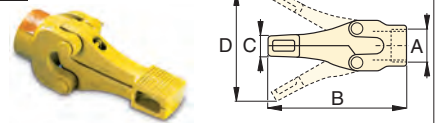

Tons	Model No.	A	B	C	D
1.0	WR-5	—	8.78	.50	3.70
1.0	A-92	2 1/4"-14 UN	9.63	1.38	6.25

21 Lock Pin

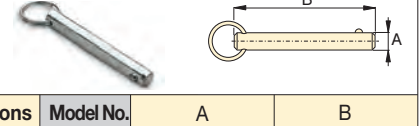

Tons	Model No.	A	B
2.5	MZ-4013	.25	2.38
5.0	A-16	.44	3.25

22 Lock-on Connector

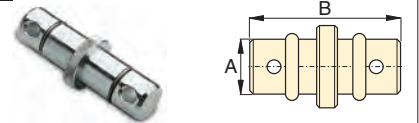

Tons	Model No.	A	B
2.5	MZ-4007	.75	3.12
5.0	MZ-1050	1.31	5.00

23 Male Lock-on Adaptor

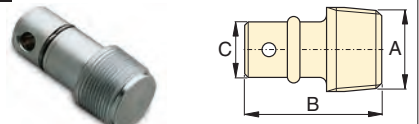

Tons	Model No.	A	B	C
2.5	MZ-4008	3/4"-14 NPT	2.38	.75
5.0	MZ-1051	1 1/4"-11 1/2 NPT	3.56	1.31

24 Female Lock-on Adaptor

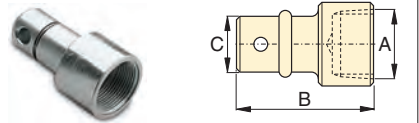

Tons	Model No.	A	B	C
2.5	MZ-4009	3/4"-14 NPT	2.56	.75
5.0	MZ-1052	1 1/4"-11 1/2 NPT	3.81	1.31

25 Adjustable Extension

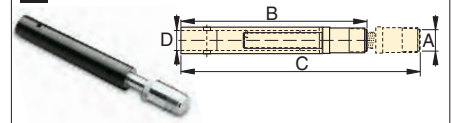

Tons	Model No.	A	B	C	D
5.0	A-285	1 1/4"-11 1/2 NPT	13.20	17.37	1.30

26 Slip-Lock Extension

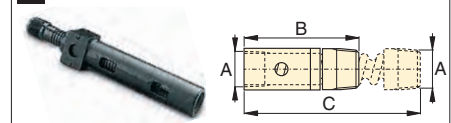

Tons	Model No.	A	B	C
2.5	A-650	3/4"-14 NPT	7.88	14.37

▼ Shown: SP-35S



- .50" thick mild steel maximum capacity
- Round, oblong and square punches and dies are available to solve your punching applications
- Long life Enerpac single-acting, spring return design
- Durable case keeps tools and dies together and provides for easy carrying and storage
- CR-400 female coupler included

Much Faster than Drilling...



Tool Kit SPK-10

Included with all 35 ton punches, this tool kit is used to remove and install the punch into the head.

Can be ordered as a replacement under model number **SPK-10**.



Ordering Information

The 35-ton hydraulic punch may be ordered by itself or as a set, including an electric, air or hand pump.

Please refer to the Quick Selection Chart information on next page.

A punch and die may also be ordered as a matched set.

▼ STANDARD PUNCH AND DIE SETS SELECTION CHART

Hole Shape	Imperial*		Metric*	
	Hole Size (in)	Bolt Size (in)	Hole Size (mm)	Bolt Size (mm)
●	.31	1/4	7,9	–
●	.38	5/16	9,5	M8
●	.44	3/8	11,1	M10
●	.53	7/16	13,5	M12
●	.56	1/2	14,3	–
●	.69	5/8	17,5	M16
●	.78	–	19,8	M18
●	.81	3/4	20,6	–
■	.31	1/4	7,9	–
■	.38	5/16	9,5	M8
■	.44	3/8	11,1	M10
■	.50	7/16	12,7	M12
○	.31 x .75	1/4	7,9 x 19	–
○	.38 x .75	5/16	9,5 x 19	M8
○	.44 x .75	3/8	11,1 x 19	M10
○	.50 x .75	7/16	12,7 x 19	M12

* Material thickness should **not** exceed hole diameter.

▼ SP-Series, Lightweight Hydraulic Punch – much faster than drilling.



Single-Acting, Spring Return Hydraulic Punch

▼ QUICK SELECTION CHART

	Included				Model Number	Weight (lbs)
	Punch and Die Set	Pump	Pump Type	Hose		
SP-35	—	—	—	—	SP-35	35
SP-35	Standard**	—	—	—	SP-35S	40
SP-35	Standard**	PUD-1100B	E	HC-7206	SP-35SP	70
SP-35	Metric***	—	—	—	MSP-351	40
SP-35	Standard**	P-392	H	HC-7206	STP-35H	55
SP-35	Standard**	PATG-1102N	A	HC-7206	STP-35A	63

* Punch oil capacity: 4.58 in³

Includes the following punch and die sets:

** SPD-438, SPD-688, SPD-563 and SPD-813

*** SPD-375, SPD-531, SPD-438 and SPD-688

◆ E = Electric
H = Hand
A = Air operated

SP, MSP, STP Series



Capacity:
35 tons

Hole Sizes:
0.31-0.81 inch

Maximum Operating Pressure:
10,000 psi

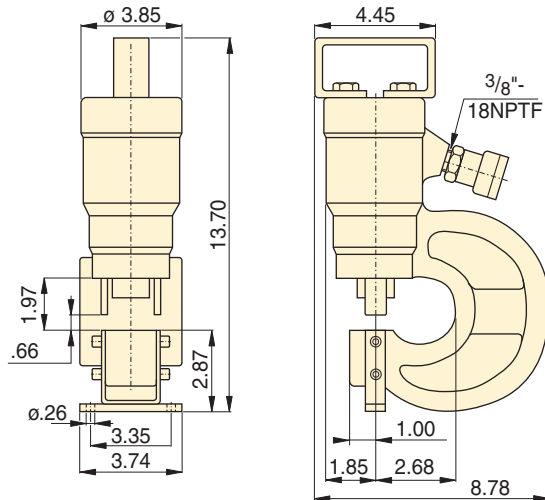

CAUTION!
Chart below is for reference only! Maximum allowable material thickness to be punched varies with set wear.



CAUTION!
Material thickness should not exceed hole diameter.

 Standard Punch & Die Set Model No.	Maximum Allowable Material Thickness To Be Punched (in) (Material thickness should not exceed hole diameter.)										
	1)	2)	3)	4)	5)	6)	7)	8)	9)	10)	11)
SPD-313	.31	.31	.25	.25	.25	.25	.13	.19	.25	.25	.25
SPD-375	.38	.38	.31	.31	.31	.31	.19	.25	.31	.31	.31
SPD-438	.44	.44	.38	.38	.38	.31	.19	.31	.31	.31	.31
SPD-531	.50	.50	.44	.44	.44	.38	.25	.31	.38	.38	.38
SPD-563	.50	.50	.50	.44	.50	.44	.25	.38	.44	.44	.44
SPD-688	.50	.50	.50	.44	.50	.40	.25	.31	.40	.40	.40
SPD-781	.50	.50	.50	.44	.50	.38	.25	.31	.38	.39	.38
SPD-813	.50	.50	.50	.44	.50	.31	.19	.31	.31	.31	.31
SPD-458	.31	.31	.25	.25	.25	.25	.13	.19	.25	.25	.25
SPD-549	.38	.38	.31	.31	.31	.31	.19	.25	.31	.31	.31
SPD-639	.44	.44	.38	.38	.38	.31	.19	.31	.31	.31	.31
SPD-728	.50	.50	.44	.44	.44	.38	.25	.31	.38	.38	.34
SPD-106	.31	.31	.25	.25	.25	.25	.13	.19	.25	.25	.25
SPD-125	.38	.38	.31	.31	.31	.31	.19	.25	.31	.31	.31
SPD-188	.44	.44	.38	.38	.38	.31	.19	.31	.31	.31	.31
SPD-250	.50	.50	.44	.44	.44	.38	.25	.31	.38	.38	.38

Steel Qualities (see table):

- 1) Mild A-7
- 2) Boiler Plate
- 3) Structural A-36
- 4) Struct Corten (ASTM A242)
- 5) Cold Rolled C-1018
- 6) Hot Rolled C-1050
- 7) Hot Rolled C-1095
- 8) Hot Rolled C-1095 Annealed
- 9) Stainless Annealed
- 10) Stainless 304 Hot Rolled
- 11) Stainless 316 Cold Rolled

▼ Shown: SP-50100



- Available as a complete set including electric pump and hoses
- Double-acting cylinder design for fast cycle times
- Punch and die changeover tools included
- Lifting handle for easy carrying
- Adjustable power stripper prevents movement of the metal during stripping
- CR-400 female couplers included

Cuts the Time Spent Forming Holes



Depth Stop

For simplified repetitive punching applications an adjustable Depth Stop is available.

Order model number: **SP-110.**



Foot Mounting Kit

A foot mounting kit for easy mounting of the 50 ton punch to workbench or fixture is available.

Please order: **SP-120.**



Ordering Information

The 50-ton Hydraulic Punch may be ordered by itself or as a set with an electric pump. A punch and die may be ordered as a matched set. Please refer to the selection chart information.



◀ Save time using this 50-ton Enerpac Punch.

▼ Shown below is the 50-ton punch with SP-120 and SP-110 assembled.



50-Ton Hydraulic Punch

▼ QUICK SELECTION CHART PUNCH SETS

Model Number Punch*	Included			Set Model Number	Weight (lbs)
	Punch & Die Sets 	Pump	Hose (2x)		
SP-50	All**	-	-	SP-50100	255
SP-50	All**	ZE4410SB-N	HC-7206	SP-5000	384

* Punch Oil Capacity:
Advance: 17 in³
Retract: 14 in³

** All standard sets from chart below.

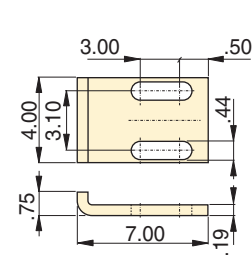

SP-110

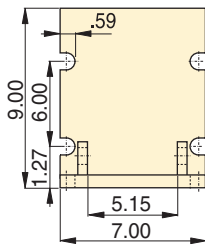

SP-120

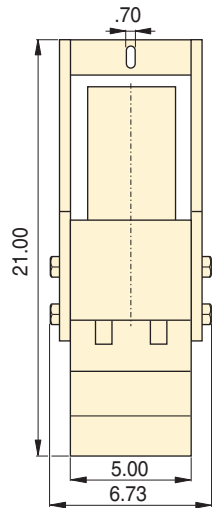
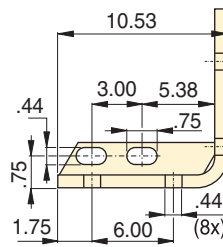

SP-50

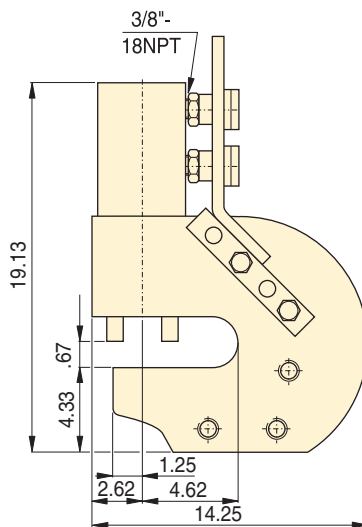

SP Series



Capacity:

50 tons

Hole Sizes:

0.53-1.03 inches

Maximum Operating Pressure:

10,000 psi



CAUTION!

Material thickness should not exceed hole diameter.



CAUTION!

Chart below is for reference only! Maximum allowable material thickness to be punched varies with set wear.

Steel Qualities (see table below):

- 1) Mild A-7
- 2) Boiler Plate
- 3) Structural A-36
- 4) Struct Corten (ASTM A242)
- 5) Cold Rolled C-1018
- 6) Hot Rolled C-1050
- 7) Hot Rolled C-1095
- 8) Hot Rolled C-1095 Annealed
- 9) Stainless Annealed
- 10) Stainless 304 Hot Rolled
- 11) Stainless 316 Cold Rolled

▼ STANDARD PUNCH AND DIE SELECTION CHART

Hole Shape	Hole Size (in)	Bolt Size (in)	Standard Punch and Die Set  Model Numbers	Maximum Allowable Material Thickness To Be Punched (in)										
				1)	2)	3)	4)	5)	6)	7)	8)	9)	10)	11)
●	.53	1/2	SP-150	.53	.53	.53	.53	.53	.49	.32	.40	.49	.49	.49
●	.66	5/8	SP-170	.56	.56	.56	.50	.56	.51	.32	.40	.51	.51	.51
●	.78	3/4	SP-190	.56	.56	.56	.50	.56	.49	.32	.40	.49	.50	.49
●	.91	7/8	SP-121	.56	.56	.56	.50	.56	.35	.22	.35	.35	.35	.35
●	1.03	1	SP-123	.56	.56	.56	.44	.56	.31	.19	.31	.31	.31	.31

Vertical Lifting Wedge

▼ Shown: LW-16 with SB-2 and optional LWB-1



LW Series

Minimum Clearance:

.39 inches

Maximum Lift Height:

2.02*-2.72* inches

Maximum Force:

16 tons

Maximum Operating Pressure:

10,000 psi



Best Match Manual Pump

To power your Enerpac Lifting Wedge, The Enerpac P-392 Hand Pump or P-392FP Foot Pump is an ideal choice.

Page: 192



Split-Flow Manifolds

Split Flow Valves to control two or four lifting wedges simultaneously.

AM-21 with 3 ports 3/8" NPTF.
AM-41 with 5 ports 3/8" NPTF.

Page: 136

- Requires .39 inch access gap
- Lifting force 16 ton at 10,000 psi hydraulic pressure
- Automatic mechanical retraction (single acting)
- Securely raises or lowers 16 tons with no slippage
- Lifting wedge LW-16 includes safety block SB-2
- Use in tandem to lift 32 tons, or 64 tons
- .83 inch of vertical lift from each step (maximum lift to 2.72 inches with optional LWB-1 stepped block)

▼ For lifting heavy equipment with minimum floor clearance the LW-16 is the ideal tool.

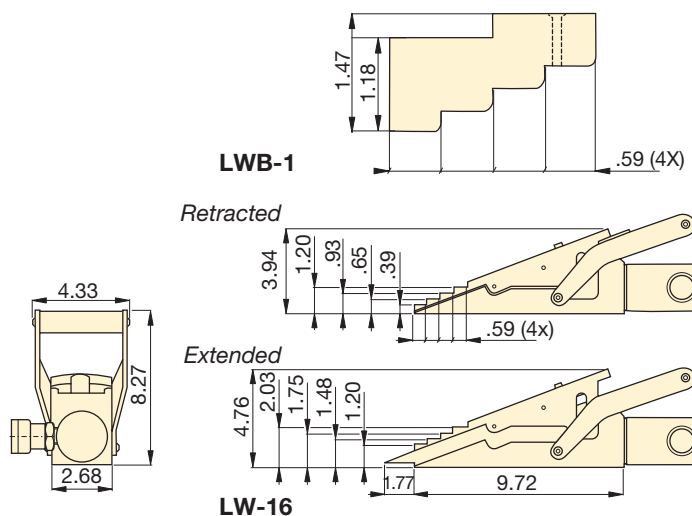
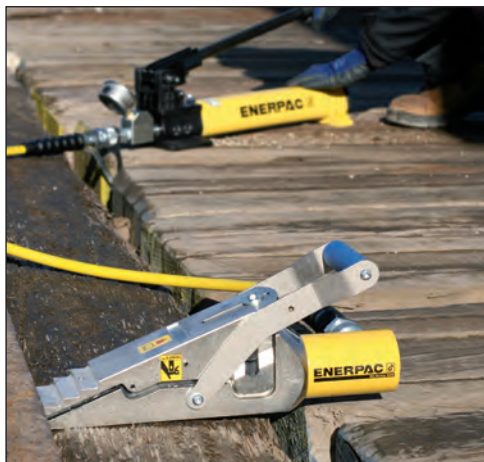

Max. Lifting Force (ton)	Model No.	Minimum Clearance Gap (in)	Max. Lift per Stage (in)	Max. Lifting Height (in)	Max. Lifting Height Using Stepped Block (in)	Oil Capacity (in ³)	Weight (lbs)
16	LW-16	.39	.83	2.02	2.72	4.75	15.4

* Use optional stepped block LWB-1 to increase wedge lifting height 1.18 inches.

▼ Shown from left to right: SOH-10-6, SOH-23-6



SOH Series

Lifting Capacity:

8.5-20 tons

Stroke:

5.39-6.18 inches

Toe Clearance:

0.79-1.18 inches

Maximum Operating Pressure:

10,000 psi



ER-Series Load Skates

In combination with the Enerpac Lifting Wedge we recommend Load Skates for moving heavy loads.

Page: 194



RSM Flat-Jac®

Low height, single acting spring-return cylinders are ideal for space restricted applications.

Page: 22

- For lifting heavy equipment with minimum available access
- Remote operation of hydraulic pump enhances safety
- Low-height lifting toe
- Precision guided to reduce friction and isolate cylinder from side-loads
- Two extendable support feet provide extra stability
- Includes RC-Series cylinder with CR-400 coupler

▼ Heavy transport using Load Skates. The machine is first lifted, using SOH-Series Enerpac Machine Lifts.

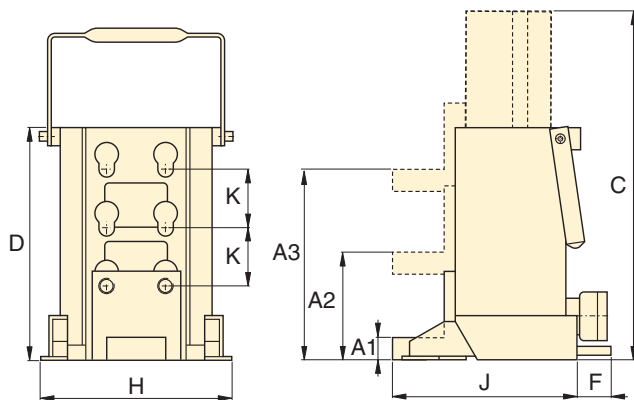

Capacity (ton)	Toe Clearance with Cylinder Retracted (in)			Stroke (in)	Model Number	Oil Capacity (in ³)	Dimensions (in)						Weight (lbs)
	Minimum A1	Central A2	Maximum A3				Total Ext. Height C	Total Body Height D	F	H	J	K	
8.5	.79	3.74	6.69	5.39	SOH-10-6	13.7	17.00	11.61	–	7.48	8.46	2.95	59.2
20	1.18	4.33	7.48	6.18	SOH-23-6	32.0	18.58	12.40	2.56	10.24	9.84	3.15	99.2

▼ Shown: Set ERS-20

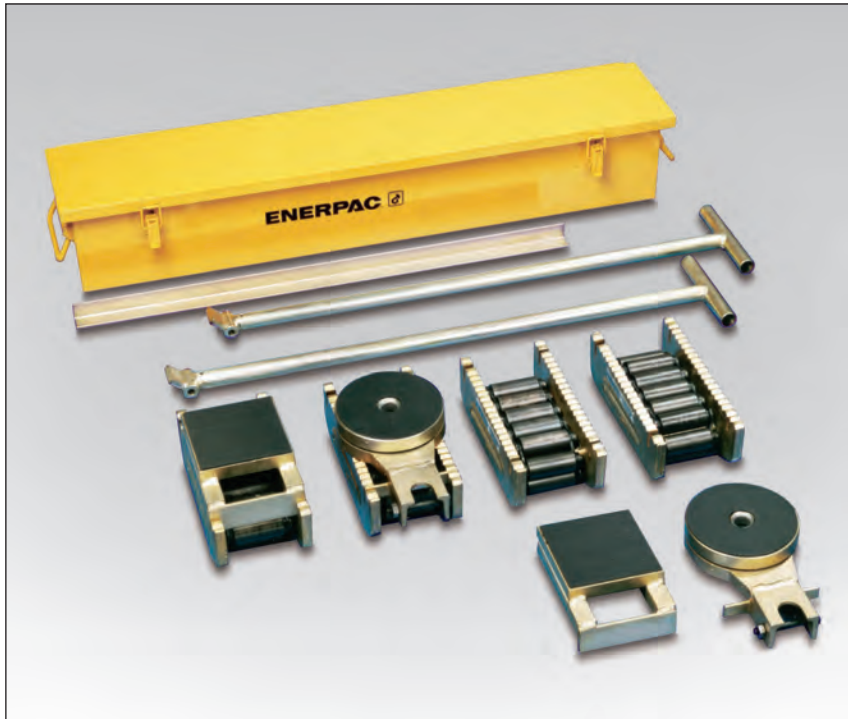

Move Heavy Loads Easily and Safely



Sets (see table) include all components necessary to handle a variety of applications. Two **ELB-1** link-up bars, two **ERH-1** handles (34.4" long) and one **EMB-1** metal box are included. Optional long handle **ERH-2** (46.4") also available.

- Rugged and sturdy construction for long life
- Low profile construction for increased stability
- Low rolling-resistance allows for easy load movement
- Attachable load leveling plates and swivel turntables for turning corners



Lifting Wedge and Machine Lifts

To place the Load Skates, the load must first be lifted. This can be done easily and safely using Enerpac Lifting Wedge or Machine Lifts.

Page: 194

▼ Heavy transport using Load Skates. The machine is first lifted, using SOH-Series Enerpac Machine Lifts.



▼ Chemical tank transportation: The first inch(s) the load was lifted with an RCS-Series Low Height Cylinder and then moved onto load skates for transportation.



Heavy-Duty Caterroller™ Load Skates

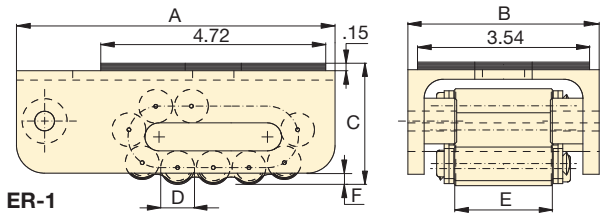

ER-1

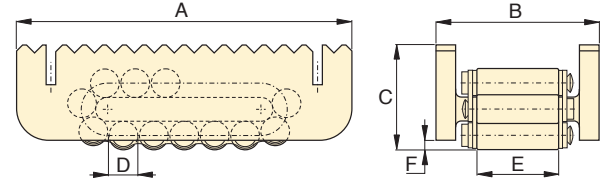

ER-10, ER-15, ER-30

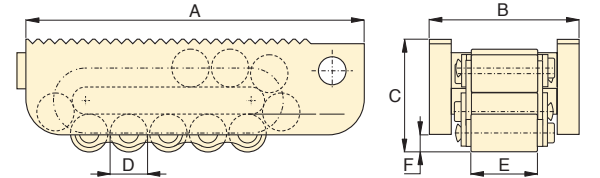

ER-60, ER-80

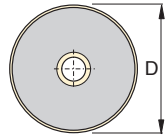

Turntable Swivel ES-1

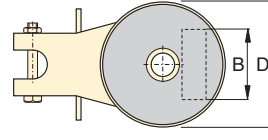

Turntable Swivel ES-10, ES-15, ES-30

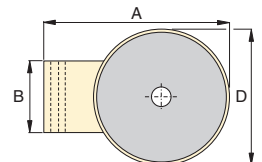

Turntable Swivel ES-60, ES-80

**ELP,
ER,
ES
Series**



Maximum Carrying Capacity:
80 tons

Load Skates may be ordered separately or as a matched set.					
Set Capacity* (tons)	Set Model Number	Load Skates (4)	Turntable Swivels (2)	Leveling Plates (2)	Weight Including handles and metal box (lbs)
20	ERS-20	ER-10	ES-10	ELP-10	110
30	ERS-30	ER-15	ES-15	ELP-15	123
60	ERS-60	ER-30	ES-30	ELP-30	167

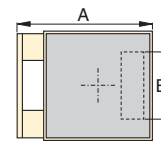

Leveling Plate ELP-10, ELP-15, ELP-30

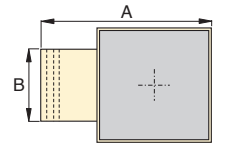

Leveling Plate ELP-60, ELP-80

* Sets are designed to enable two skates to take full load for extra safety on uneven floor surfaces

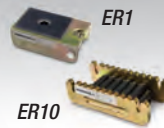
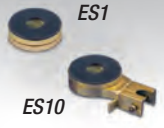
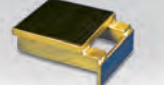
	Capacity (ton)	Model Number	Dimensions (inch)						Contact Rolls per Skate	Rollers per Skate	Weight (lbs)
			A	B	C	D	E	F			
Load Skates 	1	ER-1	6.69	3.94	2.56	.71	2.00	.24	4	11	8.4
	10	ER-10	8.27	3.94	2.63	.71	2.00	.24	5	15	11.5
	15	ER-15	8.69	4.45	2.95	.94	2.38	.39	4	13	16.0
	30	ER-30	10.63	5.13	3.63	1.18	2.69	.39	4	13	28.6
	60	ER-60	15.00	6.63	4.94	1.65	3.00	.63	4	13	70.4
Turntable Swivel 	1	ES-1	8.15	-	1.02	3.54	-	-	-	-	2.4
	10	ES-10	8.66	2.87	1.65	5.12	-	-	-	-	8.1
	15	ES-15	8.66	3.39	1.65	5.12	-	-	-	-	8.1
	30	ES-30	9.84	3.78	1.89	5.91	-	-	-	-	11.7
	60	ES-60	10.83	4.49	2.40	7.48	-	-	-	-	30.1
Leveling Plate 	10	ELP-10	5.87	2.87	1.65	4.72	-	-	-	-	8.1
	15	ELP-15	5.87	3.39	1.65	4.72	-	-	-	-	8.1
	30	ELP-30	7.01	3.78	1.89	5.12	-	-	-	-	11.6
	60	ELP-60	10.63	4.49	2.40	7.09	-	-	-	-	30.4
	80	ELP-80	13.78	5.04	2.40	7.87	-	-	-	-	41.4

▼ Shown: **CM-16**



CM Series

Case Size:

.67-16 Cubic Ft.

Protect your Equipment



Maintenance Sets

Enerpac Maintenance sets are a complete assortment of accessories matched to hydraulic powered tools. Using these sets allows you to quickly configure a unique tool to meet your most difficult jobs.

Built around the Enerpac lightweight hand pump, hose and cylinder, these sets enable you to push, pull, lift, press, straighten, spread and clamp with forces up to 12.5 tons.



Hydraulic Pullers

These hydraulic pullers eliminate time-consuming and unsafe hammering, heating or prying.

Damage to parts is minimized through the use of controlled hydraulic power.

- **Protect your equipment from dust, water, grease and dirt**
- **Reduce losses on the jobsite, maintenance area or shop**
- **Durable steel, painted with rust-resistant primer and finished in durable enamel**
- **Heavy-duty hinges and lifting handles**
- **Lockable**

▼ *When not storing the lifting system, this heavy-duty storage case doubles as a work station.*



Page: **172**

Case Size	Model Number	Dimensions L x W x H	Thickness	Weight
(ft ³)		(in)	(in)	(lb)
.67	CM-6	23.5 x 7 x 7	.035	15.4
1.13	CM-1	25 x 11.5 x 6.6	.035	17.6
4.50	CM-4	31 x 18 x 14	.059	35.3
7.50	CM-7	47.5 x 15 x 18	.074	125.7
16.00	CM-16	48 x 24 x 24	.059	121.3

Hydraulic Wedgie and Spread Cylinders

▼ Shown clockwise from top: **WR-15, WR-5, A-92**



A, WR Series

Capacity:
0.75-1.00 ton

Tip Clearance:
0.50-1.38 inches

Maximum Spread Range:
3.70-11.50 inches

Maximum Operating Pressure:
10,000 psi



RC-Series DUO Cylinders

10 ton RC-Series DUO cylinders (except RC-101) fit into A-92 Spreader Attachment.

Page: 6



Best Match Hand Pump

To power your WR5 and WR15 the **P-392** hand pump is an ideal choice.

Page: 70

- Single-acting, spring return
- **WR-15:** For long stroke spreading applications
- **WR-5:** For use in very confined work areas
- **A-92:** Spreader attachment screws onto RC-Series 10-ton cylinders (except RC-101)*

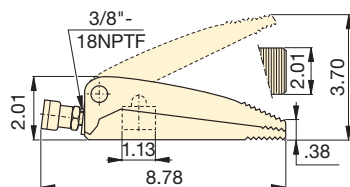

WR-5

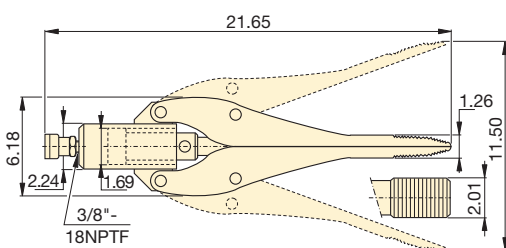

WR-15

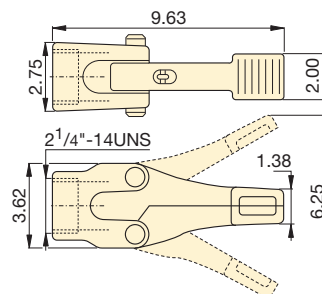

A-92*

▼ A WR-5 Wedgie cylinder is used to loosen a bridge bearing.

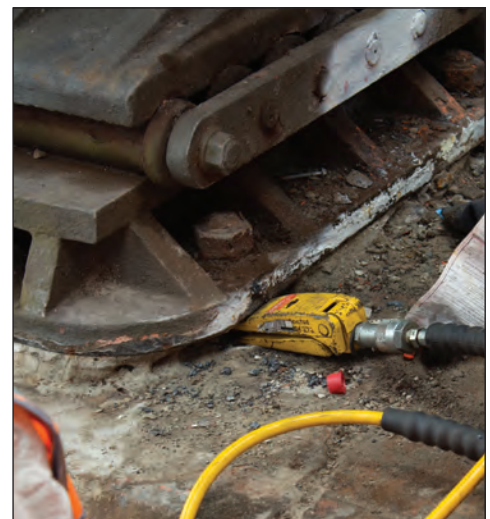

Spreader Capacity	Tip Clearance	Model Number	Maximum Spread	Cylinder Effective Area	Oil Capacity	Wt.
(ton)	(in)		(in)	(in ²)	(in ³)	(lbs)
1.00	.50	WR-5	3.70	1.00	.61	5.0
.75	1.26	WR-15	11.50	2.25	3.91	25.0
1.00	1.38	A-92*	6.25	–	–	8.0

* Maximum system pressure must be limited to half the rated pressure (5000 psi)

▼ Shown from left to right: **WHC-3380, WHC-750**



WHC, WHR, WCB, STC Series

Capacity:
3-20 tons

Cutting Capacity:
0.50-4 inches

Maximum Operating Pressure:
10,000 psi

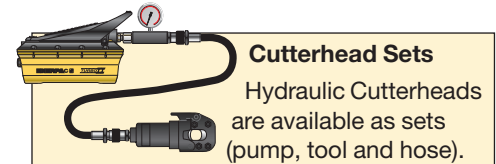

Cutter Model Number	Pump Model Number	Set Model Number *
WHC-750	P-392	STC-750H
WHC-750	P-392FP	STC-750FP
WHC-750	PATG-1102N	STC-750A
WHC-1250	P-392	STC-1250H
WHC-1250	P-392FP	STC-1250FP
WHC-1250	PATG-1102N	STC-1250A

*H = Hand Pump, A = Air Operated Pump
FP = Foot Pump

- Single acting, spring return on all models, except WHR-1250
- Guillotine action for efficient operation
- Lifting handles on larger models
- Carrying bag included for easy carrying and tool protection
- Ideal for use with most Enerpac pumps featuring 3-way valve or dump valve and 10,000 psi pressure rating (except WHR-1250, which requires 4-way valve)
- CR-400 coupler and dust cap included on all models

▼ Steel rope is easily cut with the smooth guillotine action of an Enerpac cutterhead.



▼ Selection Chart Maximum Cutting Capacities (diameter in inches)

Cutter Head Operation	Capacity (ton)	Model Number	Oil Capacity (in ³)	Length (in)	Steel Wire Rope, Hemp-core or IWRC 6x7 6x12 6x19	Round Bar				Wire Strand			Cable		Wt. (lbs)	Replacement Blades	
						Copper Wire or Bar	Aluminum Wire or Bar	Soft Steel Bolts	Reinforcing Bar	Bare Copper Wire Strands	Bare Aluminum Wire Strands	ACSR	Guy Steel Wire Strands	Telephone Cable CPP			Underground Cable (Power)
Single-acting	4	WHC-750*	1.2	5.0	.63	.75	.75	.56	.50***	.75	.75	.75	.63	☆	☆	7	WCB-750
	20	WHC-1250*	8.2	11.00	1.25	1.25	1.25	1.25	1.00	1.25	1.25	1.25	.88	☆	☆	25	WCB-1250
	13	WHC-2000	7.3	15.00	1.00	1.25	1.25	.88	☆	2.00	2.00	2.00	.75	☆	2.00	23	WCB-2000
	3	WHC-3380	4.0	19.00	☆	☆	☆	☆	☆	3.00	3.00	☆	☆	3.38	3.38	20	WCB-3380
	8	WHC-4000	8.4	24.00	☆	☆	☆	☆	☆	3.50	3.50	☆	☆	4.00	4.00	32	WCB-4000
D/A**	20	WHR-1250	7.5	16.50	1.25	1.25	1.25	1.25	1.00	1.25	1.25	1.25	.88	☆	☆	26	WCB-1250

* Available in sets. ** D/A = Double-acting *** Low Alloy

☆ Will not cut designated material

Self-Contained Hydraulic Cutters

▼ Shown from left to right: **WMC-2000, WMC-750**



- Rotating heads for operator convenience
- Guillotine action (except WMC-1000) for efficient operation
- Carrying bag included for easy carrying and tool protection
- Velcro straps to secure handles on larger models for easy transportation
- Spring return on all models
- Lightweight, self-contained tool, can be used anywhere

WMC, WCB Series

Capacity:

3-20 tons

Maximum Material Diameter:

0.38-3.38 inches

Maximum Operating Pressure:

10,000 psi



Replacement Blades

To order 60-62HRC hardened replacement blades use one of the model numbers shown below.

For Cutter Model Number	Order Blade Model Number
WMC-580	WCB-750
WMC-750	WCB-750
WMC-1000	WCB-1000
WMC-1250	WCB-1250
WMC-1580	WCB-1580
WMC-2000	WCB-2000
WMC-3380	WCB-3380



Caution!

A "☆" in the charts on these pages means that this hydraulic cutter is not designed to cut this size or type of material. Any attempt to do so may result in personal injury and damage to the unit and will void the warranty.

▼ Selection Chart Maximum Cutting Capacities (diameter in inches)

Capacity (ton)	Model Number	Length (in)	Steel Wire Rope, Hemp-core or IWRC 6x7 6x12 6x19	Round Bar				Wire Strand					Cable		Weight (lbs)
				Copper Wire or Bar	Aluminum Wire or Bar	Soft Steel Bolts	Reinforcing Bar	Bare Copper Wire Strands	Bare Aluminum Wire Strands	ACSR Wire Strands	Guy Steel Wire Strands	Guy Steel Wire Strands	Telephone Cable CPP	Underground Cable (Power)	
4	WMC-580	15.00	.63	.63	.63	.63	.38	.63	.63	.63	.56	.56	☆	.63	8
4	WMC-750	15.00	.75	.75	.75	.69	.50***	.75	.75	.75	.56	.56	☆	.75	8
20	WMC-1000*	26.75	☆	.75	.75	.75	.75	☆	☆	☆	☆	☆	☆	☆	25
20	WMC-1250	26.75	1.25	1.25	1.25	1.25	.88	1.25	1.25	1.25	.88	.88	☆	☆	23
6	WMC-1580	22.00	.75	.75	.75	.75	☆	1.50	1.50	1.50	.63	.63	☆	1.63	15
13	WMC-2000	24.75	1.00	1.25	1.25	.88	☆	2.00	2.00	2.00	.75	.75	☆	2.00	24
3	WMC-3380	26.00	☆	☆	☆	☆	☆	3.00	3.00	☆	☆	☆	3.38	3.38	22

* Cuts .50" alloy chain grade 70 (type G7 transport or tie-down) or grade 80 (for overhead lifting applications)

☆ Will not cut designated material

*** Low Alloy

▼ Shown: **STB-101H**



Quick, Safe and Wrinkle-free Bending



'One Shot' and 'Sweep'

One shot shoes give up to a 90° bend without resetting.

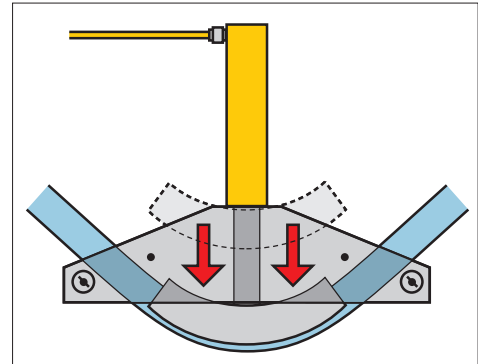

Sweep shoes are used where increased radii are required for multiple parallel pipe installations.

- Makes smooth, wrinkle-free bends
- Sets include cylinder, hose and manual, air or electric pump
- Sets are also available without hydraulics
- Bending shoes and bending frame are lightweight, heat-treated aluminum
- All sets include sturdy steel storage case
- All sets include BZ-12091 angle indicator for accurate bending
- BZ-12377 Shoe Lock Pin included in every set
- Eject-O-Matic™ benders (STB-202 models) use a double-acting cylinder to eject pipe from the bending shoe



▲ Typical one shot bending operation.

▼ SELECTION CHART

Pipe Range		Set Model Number	Hand Pump*	Air Pump*	Electric Pump*	Cylinder*	Hose*	Steel Case*	Saddle	Weight (includes steel case)
One Shot	Sweep									
½ - 2	-	STB-101X	-	-	-	-	-	CM-4	A-12	88
		STB-101N	-	-	-	RC-1010	HC-7206	CM-4	A-12	105
		STB-101H	P-392	-	-	RC-1010	HC-7206	CM-4	A-12	114
		STB-101A	-	PATG-1102N	-	RC-1010	HC-7206	CM-4	A-12	119
		STB-101B	-	-	PUJ-1200B ²⁾	RC-1010	HC-7206	CM-4	A-12	127
1 - 2	2½ - 4	STB-221X	-	-	-	-	-	CM-7	A-29	229
		STB-221N	-	-	-	RC-2510	HC-7206	CM-7	A-29	263
		STB-221H	P-80	-	-	RC-2510	HC-7206	CM-7	A-29	286
1¼ - 4	-	STB-202X ¹⁾	-	-	-	-	-	CM-7	A-29	316
		STB-202N ¹⁾	-	-	-	RR-3014	HC-7206 (2x)	CM-7	A-29	383
		STB-202B ¹⁾	-	-	ZU4408SB ²⁾	RR-3014	HC-7206 (2x)	CM-7	A-29	467

* See corresponding sections of this catalog for more detailed specifications.

¹⁾ Eject-O-Matic™ ²⁾ For 230 volt applications change the last digit of Set Model Number from "B" to "E".

Pipe Bender Sets

Nominal pipe size (outside dia.) (in)	Wall Thickness (in)	Schedule Pipe *	Pipe Bend Inside Radius (in)	STB-101	STB-221	STB-202	One Shot Bending Shoe Model Number	Sweep Bending Shoe Model Number
				1/2 - 2 One Shot	1-2 One Shot	1 1/4 - 4 One Shot		
1/2 (.840)	.109	40	2 7/8	Yes	-	-	BZ-12011	-
	.147	80		Yes	-	-		
	.187	160		WS	-	-		
	.294	DEH		WS	-	-		
3/4 (1.050)	.113	40	4	Yes	-	-	BZ-12021	-
	.154	80		Yes	-	-		
	.218	160		WS	-	-		
	.308	DEH		WS	-	-		
1 (1.315)	.133	40	5 1/8	Yes	Yes	-	BZ-12031	-
	.179	80		Yes	Yes	-		
	.250	160		WS	WS	-		
	.358	DEH		-	WS	-		
1 1/4 (1.660)	.140	40	6 7/8	Yes	Yes	Yes	BZ-12041	-
	.191	80		Yes	Yes	Yes		
	.250	160		WS	WS	Yes		
	.342	DEH		-	WS	WS		
1 1/2 (1.900)	.145	40	7 7/8	Yes	Yes	Yes	BZ-12051	-
	.200	80		Yes	Yes	Yes		
	.281	160		WS	WS	Yes		
	.400	DEH		-	WS	WS		
2 (2.375)	.154	40	8 5/8	Yes	Yes	Yes	BZ-12061	-
	.218	80		-	Yes	Yes		
	.343	160		-	WS	Yes		
2 1/2 (2.875)	.203	40	9 1/2	-	Yes	Yes	BZ-12341	BZ-12382
	.276	80		-	WS	Yes		
	.375	160		-	WS	Yes		
3 (3.500)	.216	40	11 1/4	-	Yes	Yes	BZ-12351	BZ-12383
	.300	80		-	WS	Yes		
3 1/2 (4.000)	.226	40	15 1/2	-	Yes	Yes	BZ-12391	BZ-12384
	.318	80		-	WS	Yes		
4 (4.500)	.237	40	17 3/4	-	Yes	Yes	BZ-12392	BZ-12385
	.337	80		-	-	Yes		

*Schedule Pipe: 40 = Standard; 80 = Extra Heavy; 160 = Double Extra Heavy;
 DEH = Double Extra Heavy (slightly thicker than 160);
 WS = Can be bent by using wider spacing for swivel shoes.

STB Series



Nominal Pipe Size:

0.5-4 inches

Maximum Bend Angle:

90°

Maximum Operating Pressure:

10,000 psi



All bender sets are designed to bend mild steel pipe. For other material please consult Enerpac.

Frame Assembly	Pivot Pin**	Pivot Shoes**	One Shot or Sweep ³⁾ Bending Shoes included									Set Model Number	
BZ-12371	BZ-12375	BZ-12071	BZ-12011	BZ-12021	BZ-12031	BZ-12041	BZ-12051	BZ-12061	-	-	STB-101X		
												STB-101N	
													STB-101H
													STB-101A
													STB-101B
BZ-12372	BZ-12376	BZ-13401	BZ-12031	BZ-12041	BZ-12051	BZ-12061	BZ-12382 ³⁾	BZ-12383 ³⁾	BZ-12384 ³⁾	BZ-12385 ³⁾	STB-221X		
											STB-221N		
												STB-221H	
BZ-12374	BZ-12376	BZ-13401	-	BZ-12041	BZ-12051	BZ-12061	BZ-12341	BZ-12351	BZ-12391	BZ-12392	STB-202X ¹⁾		
											STB-202N ¹⁾		
												STB-202B ¹⁾	

³⁾ Shoes are Sweep, all other shoes are One Shot.
 ** Sets include two pivot pins and two pivot shoes.

Enerpac's Bolting Solutions caters to the complete bolting work-flow, ensuring joint integrity in a variety of applications throughout industry:

Joint Assembly

From simple pipe alignment to complex joint positioning of large structural assemblies, our comprehensive line of joint assembly products range from hydraulic and mechanical alignment tools to PLC-controlled multi-point positioning systems.

Controlled Tightening

Enerpac offers a variety of controlled tightening options to best meet the requirements of your application, ranging from manual torque multipliers, to pneumatic torque wrenches, as well as a comprehensive range of hydraulic torque wrenches and inter-connectable bolt tensioning tools.

Joint Separation

Enerpac also provides hydraulic nut splitters and a variety of mechanical and hydraulic spreading tools for joint separation during inspection, maintenance and decommissioning operations.

High-quality bolting solutions from the brand you can trust. See how Enerpac can make your bolting work-flow more accurate, safer and efficient.



Bolting Integrity Software

Visit www.enerpac.com to access our free on-line bolting software application and obtain information on tool selection, bolt load calculations and tool pressure settings. A combined application data sheet and joint completion report is also available.



Torque Tightening























See our "Yellow Pages" for information on torque tightening.

Page: 286



All information in this catalog can be changed due to product improvements without prior notice.

Bolting Tools and Pumps Section Overview

	Capacity	Tool Type and Functions	Series		Page
Controlled Tightening and Loosening	750-8000 Ft.lbs	Manual Torque Multipliers	E		204 ▶
	1400-26,150 Ft.lbs	Square Drive Hydraulic Torque Wrenches-Steel	S		206 ▶
	3/4 – 6 1/8 inches 19 - 155 mm	Heavy-duty Impact Sockets Square Drive	BSH		210 ▶
	2000-35,000 Ft.lbs	Low Profile Hydraulic Torque Wrenches-Steel UltraSlim Stepped-Width Cassette	W W-SL		212 ▶ 222 ▶
	4250 Ft-lbs	Roller Cassette Torque Wrench	WCR		224 ▶
	6000 Ft-lbs	Pneumatic Torque Wrench	PTW		226 ▶
	6000 Ft-lbs	Electric Torque Wrench	ETW		228 ▶
		Selection Matrix Torque Wrenches - Pumps - Hoses			232 ▶
	Flow 20 in ³ /min.	Portable Electric Torque Wrench Pumps	PMU PME		233 ▶
	Flow 60-120 in ³ /min.	Electric Torque Wrench Pumps	TQ		234 ▶
	Flow 60-120 in ³ /min.	Electric Torque Wrench Pumps	ZU4T		236 ▶
	Flow 60-120 in ³ /min.	Electric Torque Wrench Pumps	ZE4T ZE5T		240 ▶
	Flow 60 in ³ /min.	Air Driven Torque Wrench Pump	ZA4T		242 ▶
		Tensioning Tools			
		Hydraulic Bolt Tensioners	GT		246 ▶
		High-Pressure Hand Pump	HPT		248 ▶
	Flow 8-20 in ³ /min.	Electric Tensioning Pumps	ZUTP		249 ▶
	Flow 4 in ³ /min.	High Pressure Air Pump	ATP		250 ▶
Joint Assembly / Joint Separation	1/2 - 2 7/8 A/F 2 3/4 - 5 3/8 A/F	Hydraulic Nut Cutters Hydraulic Nut Splitters	NC NS		251 ▶
	5-10 tons	Pin-type Hydraulic Flange Spreaders	FS		254 ▶
	8-14 tons	Step-type Industrial Spreader	FSM/ FSH		255 ▶
	0.3-5.0 tons	Flange Alignment Tools	ATM		256 ▶
	1-12 in. flange	Mechanical Flange Face Tool	FF		258 ▶

▼ Shown from left to right: E291, E393, E494



Accurate, Efficient Torque Multiplication

When accurate make-up or break-out of stubborn fasteners requires high torque

- High-efficiency planetary gear sets achieve high output torque from low input torque
- Most models operator protected by anti-backlash device
- Multiplier output accuracy $\pm 5\%$ of input torque
- Reversible, tighten or loosen bolts
- Reaction bar or reaction plate type
- Angle-of-turn protractor standard on E300 series models
- Reaction plate models offer increased versatility with reaction point locations
- E300 and E400 series replaceable shear drives provide overload protection of internal power train (one replacement shear drive is included)



Typical Torque Multiplier Applications

- Locomotives
- Power plants
- Pulp and paper mills
- Refineries
- Chemical plants
- Mining and construction
- Off-road equipment
- Shipyards
- Cranes



◀ Enerpac Reaction Bar Torque Multiplier E393 used to manually torque bolts up to 3,200 ft-lbs.

▼ SELECTION CHART

Torque Multiplier Type	Nominal Output Torque Capacity		Model Number
	(Ft.lbs)	(Nm)	
Reaction Bar Multiplier	750	1015	E290PLUS
	1000	1355	E291
	1200	1625	E391
	2200	2980	E392
	3200	4340	E393
Reaction Plate Multiplier	2200	2980	E492
	3200	4340	E493
	5000	6780	E494
	8000	10845	E495

Manual Torque Multipliers



Manual Torque Multipliers

Enerpac manual torque multipliers provide efficient torque multiplication in wide clearance applications and when external power sources are not available.

Manual torque multipliers are used in most industrial, construction, and equipment maintenance applications. Hydraulic torque wrenches are better suited for tight tolerance, flange and repetitious bolting applications.

Use Reaction Bar Models:

- where space is limited
- where multiple reaction points are available
- when portability is desirable

Use Reaction Plate Models:

- above 3200 Ft.-lbs. output torque
- on flanges and applications where neighboring bolt or nut is available to react against
- when extreme reaction forces are generated

E Series



Nominal Output Torque:
750-8000 Ft.lbs

Torque Ratio:
3:1-52:1

Multiplier Output Ratio Accuracy:
± 5 %

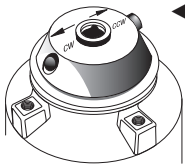

Selector Pawl

Models with anti-backlash protection have directional selector pawls. Set the pawl for clockwise or counter-clockwise rotation.

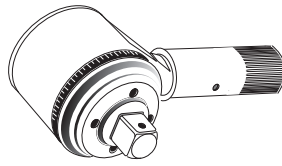

Angle-of-Turn Protractor

E391, E392 and E393 models include an angle-of-turn protractor (scale) to tighten fasteners using a "torque turn" method. Allows accurate measuring a specific number of degrees of rotation.

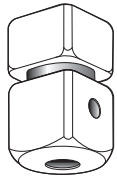

Shearable Square Drive

Designed to provide overload protection on E300- and E400-series multiplier power train by shearing when excess input torque is applied. Internal shear pin prevents tool from falling off bolt.

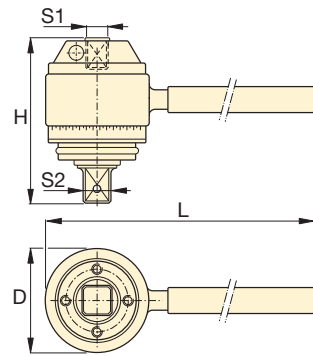

Reaction Bar Type ¹⁾

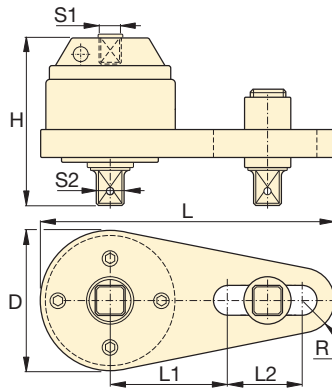

Reaction Plate Type ¹⁾



CAUTION!

Never use impact type air tools for power driving torque multipliers. Torque multiplier drive train damage will occur.



Hydraulic Torque Wrenches

Enerpac offers a complete range of square drive and hexagon cassette torque wrenches.

Page: 206



BSH-Series Sockets

Heavy-Duty Impact Sockets for power driven torquing equipment.

Page: 210

Input Torque		Torque Ratio	Input Female Square Drive		Output Male Square Drive		Over-load Protection	Anti-Back-lash	Dimensions (in)						Wt. (lbs)	Model Number
(Ft.lbs)	(Nm)		S1 (in)	S2 (in)	Replaceable Shear Drive Model No.	D			H	L	L1	L2	R			
250	338	3 : 1	1/2	3/4	–	No	No	2.8	3.3	8.6	–	–	–	4.0	E290PLUS	
333	451	3 : 1	1/2	3/4	–	No	No	2.8	3.3	17.4	–	–	–	5.5	E291	
200	271	6 : 1	1/2	3/4	E391SDK	Yes	No	3.9	4.0	19.6	–	–	–	13.8	E391	
162	219	13.6 : 1	1/2	1	E392SDK	Yes	Yes	4.1	5.7	19.6	–	–	–	18.3	E392	
173	234	18.5 : 1	1/2	1	E393SDK	Yes	Yes	4.1	6.5	19.6	–	–	–	15.2	E393	
162	219	13.6 : 1	1/2	1	E392SDK	Yes	Yes	4.9	5.5	14.0	5.5	4.9	1.3	17.2	E492	
173	234	18.5 : 1	1/2	1	E393SDK	Yes	Yes	4.9	6.4	14.0	5.5	4.9	1.3	23.4	E493	
189	256	26.5 : 1	1/2	1 1/2	E494SDK	Yes	Yes	5.6	8.7	14.9	7.0	3.5	1.7	34.0	E494	
154	208	52 : 1	1/2	1 1/2	E495SDK	Yes	Yes	5.8	10.7	15.2	7.0	3.5	1.9	50.3	E495	

¹⁾ E200 and E400-series do not have an Angle-of-Turn Protractor (scale).

User must verify manual torque wrench accuracy prior to use to ensure accurate final output torque.

▼ Shown: S3000X



Setting New Standards in Safety, Simplicity and Performance



Two Handle Styles

Robust angled positioning handles come standard with every S-Series (X-Edition) tool. Straight positioning handles are available as accessories.

Compatible S-Series (X-Edition) wrenches	Angled positioning handles (standard)	Straight positioning handles (optional)
S1500X, S3000X	SWH6A	SWH6S
S6000X, S11000X	SWH10A	SWH10S
S25000X	Supplied with an eyebolt handle (SWH10EA)	

Safety and Performance

- Compact, high-strength uni-body construction provides a small operating radius without sacrificing endurance
- 35° rotation angle and rapid return stroke for fast operation
- Tough manifold design with added safety feature for enhanced operator safety

Simplicity

- 360° click-on reaction arm with quick release lever provides easier handling, even when wearing gloves
- Includes robust handle which mounts on both sides of tool for extra maneuverability
- Push button square drive release for quickly reversing the square drive for tightening or loosening

Versatility

- Available with optional enhanced tilt and swivel TSP300 manifold for horizontal and vertical maneuverability, with greater durability*

Accuracy

- Constant torque output provides accuracy of +/-3% across full stroke
- Optional Angle-of-Turn Indicator provides measurement of rotation

* TSP300 is designed for X-Edition tools only, and is not compatible with standard edition tools. For replacement components for existing tools, refer to repair sheet on www.enerpac.com



TSP - Pro Series Swivel

The optional TSP300 tilt and swivel manifold with robust interlocking design provides 360° X-axis rotation and 160° Y-axis rotation.

How to Order*

Factory fitted to S-Series (X-Edition) wrenches: Insert a "P" prior to the "X" in the tool designation, e.g.: **S1500PX**.

Order as an accessory using the part number: **TSP300**, which can be fitted to existing S-Series (X-Edition) wrenches.

*Includes male and female couplers.

Page: 209

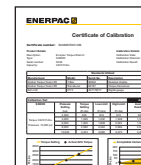

Calibration Certificate

All X-Edition tools are CE-ATEX declared, factory calibrated and are shipped complete with a calibration certificate.

S-Series, X-Edition, Square Drive Torque Wrenches

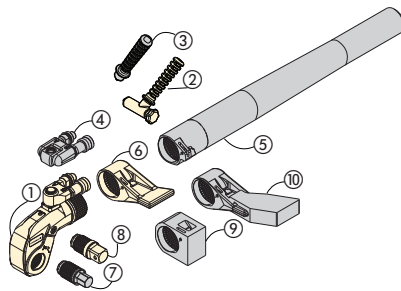

Select the Right Torque
Choose your Enerpac Torque Wrench using the untightening rule of thumb: Loosening torque equals about 250% of tightening torque.

- ① Drive Unit
- ② Angled Positioning Handle
- ③ Straight Positioning Handle (optional)
- ④ Pro Series Swivel (optional)
- ⑤ Reaction Tube Extension (optional)
- ⑥ Standard Reaction Arm
- ⑦ Allen Drive (optional)
- ⑧ Square Drive
- ⑨ Short Reaction Arm (optional)
- ⑩ Extended Reaction Arm (optional)

S Series (X-Edition)



Nominal Torque at 10,000 psi:
26,150 Ft.lbs

Square Drive Range:
3/4-2 1/2 inch

Nose Radius:
.98-2.52 inch

Maximum Operating Pressure:
10,000 psi



Accessory Options

A full list of optional accessories can be found on: page 209.

Page: **209**

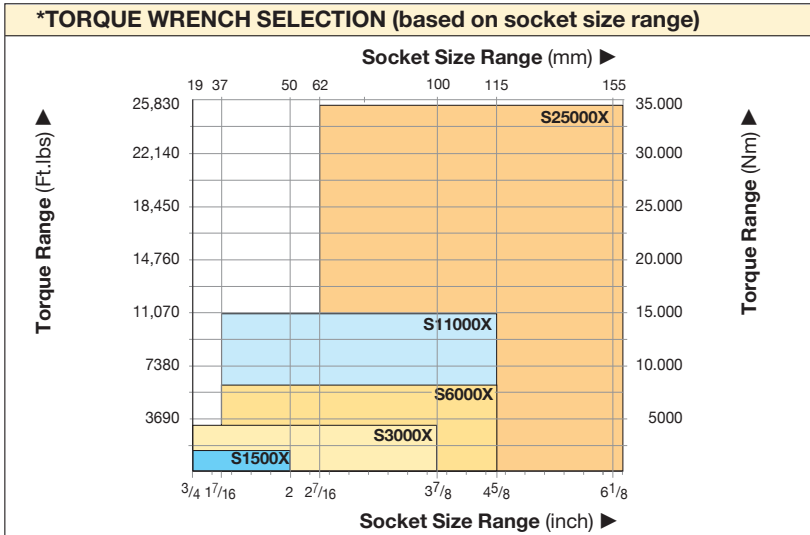

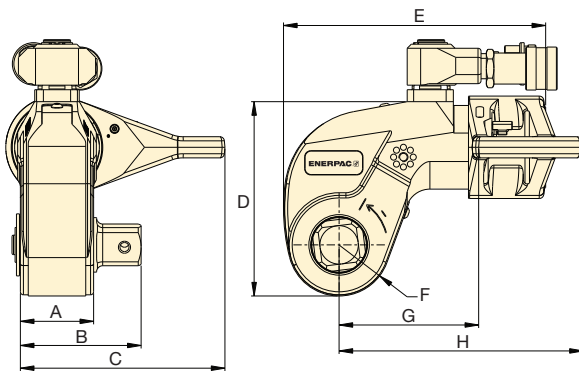

See page 210 for BSH-Sockets.



▼ The rigid steel design of the S-Series torque wrenches provides durability, reliability and safety.



Nominal Torque at 10,000 psi / 690 bar		Minimum Torque at 10,000 psi / 690 bar		Square Drive		Angle-of-Turn Model No. (optional)	Torque Wrench Model No.*	Dimensions (in)								Wt. (lbs)
				Size (in)	Model No. (included with wrench)			A	B	C	D	E	F	G	H	
(Ft.lbs)	(Nm)	(Ft.lbs)	(Nm)					A	B	C	D	E	F	G	H	
1440	1952	144	195	3/4"	SD15-012	AOT15	S1500X	1.54	2.56	4.25	3.82	5.35	0.98	2.76	5.08	7.0
3225	4373	323	438	1"	SD30-100	AOT30	S3000X	1.89	3.15	5.31	5.04	6.81	1.30	3.54	6.34	12.3
6150	8338	615	834	1 1/2"	SD60-108	AOT60	S6000X	2.17	3.62	6.65	6.18	7.56	1.57	4.33	7.40	20.2
11,175	15,151	1,118	1,515	1 1/2"	SD110-108	AOT110	S11000X	2.83	4.49	7.76	7.48	8.98	1.95	5.24	9.02	34.7
26,150	35,455	2,615	3,545	2 1/2"	SD250-208	AOT250	S25000X	3.50	5.63	9.69	9.61	11.30	2.52	7.17	11.61	70.8

* To order a S-series (X-Edition) wrench fitted with the TSP swivel, insert a "P" prior to the "X" in the tool designation. e.g., **S1500PX**.

SDA-Series, Allen Drives

- ① Drive Unit
- ② Angled Positioning Handle
- ③ Straight Positioning Handle (optional)
- ④ Pro Series Swivel (optional)
- ⑤ Reaction Tube Extension (optional)
- ⑥ Standard Reaction Arm
- ⑦ Allen Drive (optional)
- ⑧ Square Drive
- ⑨ Short Reaction Arm (optional)
- ⑩ Extended Reaction Arm (optional)

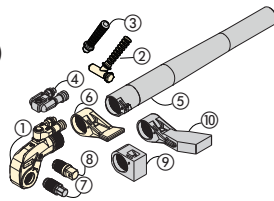

Nominal Torque at 10,000 psi:

26,150 Ft.lbs.

Hexagon Size Allen Drive:

1/2-2 1/4 in. (14-85 mm)

For
S
Series
(X-Edition)

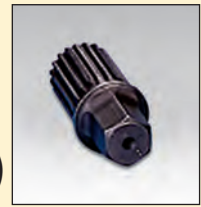

TORQUE WRENCH	OPTIONAL ALLEN DRIVES, IMPERIAL				OPTIONAL ALLEN DRIVES, METRIC				SHORT REACTION ARM FOR ALLEN DRIVES		
	Model Number	Hexagon Size (in)	Maximum Torque (Ft.Lbs)	Model Number	Dim. B1 (in)	Hexagon Size (mm)	Maximum Torque (Ft.lbs)	Model Number	Dim. B1 (in)	Model Number	Dimensions (in) C1 H1
S1500X (1440 Ft-lbs)	1/2	355	SDA15-008	2.6	14	475	SDA15-14	2.60	SRA15X	2.66	2.56
	5/8	690	SDA15-010	2.6	17	850	SDA15-17	2.68			
	3/4	1195	SDA15-012	2.8	19	1185	SDA15-19	2.76			
	7/8	1400	SDA15-014	2.9	22	1400	SDA15-22	2.87			
	1	1400	SDA15-100	3.0	24	1400	SDA15-24	2.91			
S3000X (3225 Ft-lbs)	5/8	690	SDA30-010	3.0	17	850	SDA30-17	3.03	SRA30X	3.15	2.91
	3/4	1195	SDA30-012	3.1	19	1185	SDA30-19	3.11			
	7/8	1895	SDA30-014	3.3	22	1835	SDA30-22	3.23			
	1	2825	SDA30-100	3.4	24	2385	SDA30-24	3.31			
	1 1/8	3200	SDA30-102	3.5	27	3200	SDA30-27	3.35			
	1 1/4	3200	SDA30-104	3.5	30	3200	SDA30-30	3.43			
S6000X (6050 Ft-lbs)	5/8	690	SDA60-010	3.3	17	850	SDA60-17	3.39	SRA60X	3.60	3.50
	3/4	1195	SDA60-012	3.5	19	1185	SDA60-19	3.46			
	7/8	1895	SDA60-014	3.6	22	1835	SDA60-22	3.58			
	1	2825	SDA60-100	3.7	24	2385	SDA60-24	3.66			
	1 1/8	4025	SDA60-102	3.8	27	3395	SDA60-27	3.70			
	1 1/4	5520	SDA60-104	3.9	30	4655	SDA60-30	3.78			
S11000X (11,175 Ft-lbs)	1 1/4	5520	SDA110-104	4.5	30	4655	SDA110-30	4.41	SRA110X	5.02	4.17
	1 3/8	7345	SDA110-106	4.6	32	5650	SDA110-32	4.49			
	1 1/2	9535	SDA110-108	4.6	36	8040	SDA110-36	4.61			
	1 5/8	11,000	SDA110-110	4.8	41	11,000	SDA110-41	4.76			
	1 3/4	11,000	SDA110-112	4.9	46	11,000	SDA110-46	5.00			
S25000X (26,150 Ft-lbs)	1 1/2	9535	SDA250-108	5.5	36	8040	SDA250-36	5.51	SRA250X	6.24	5.31
	1 5/8	12,120	SDA250-110	5.7	41	11,880	SDA250-41	5.67			
	1 3/4	15,135	SDA250-112	5.8	46	16,775	SDA250-46	5.83			
	1 7/8	18,620	SDA250-114	5.9	50	21,545	SDA250-50	5.94			
	2	22,595	SDA250-200	5.9	55	26,150	SDA250-55	6.06			
	2 1/4	26,150	SDA250-204	6.0	60	26,150	SDA250-60	6.22			
	-	-	-	-	65	26,150	SDA250-65	6.34			
	-	-	-	-	70	26,150	SDA250-70	6.46			
	-	-	-	-	75	26,150	SDA250-75	6.61			
-	-	-	-	85	26,150	SDA250-85	6.89				

Accessories for S-Series, X-Edition Torque Wrenches

TSP-Series, Pro Series Swivels

- Robust interlocking design
- 360° X-axis and 160° Y-axis rotation
- Increases tool fit in restricted access areas
- Simplifies hose placement
- Includes male and female couplers

**TSP
RTEX
SRSX
Series**

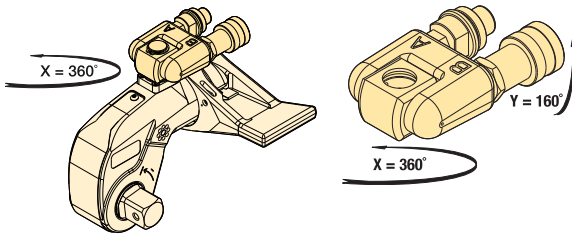

TSP Series

Torque Wrench Model Number	Model Number	Maximum Pressure (psi)	Wt. (lbs)
S1500X, S3000X, S6000X, S11000X, S25000X	TSP300*	10,000	0.44

Note: To order a S-series (X-Edition) wrench fitted with the TSP swivel, insert a "P" prior to the "X" in the tool designation, e.g., **S1500PX**.

* TSP300 is designed for X-Edition tools only, and is not compatible with standard edition tools. For replacement components for existing tools, refer to repair sheet on www.enerpac.com

RTEX-Series, Reaction Tube Extensions

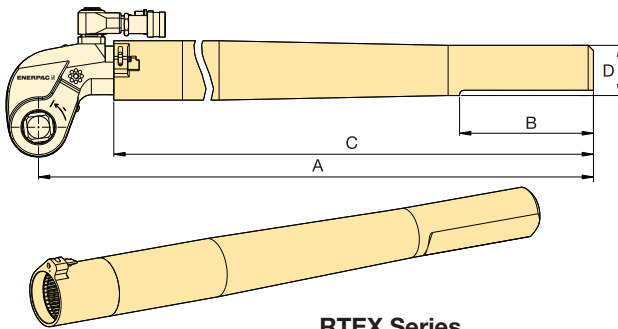

RTEX Series

- Full torque rated
- Increases tool fit in restricted access areas

Torque Wrench Model Number	Model Number	Dimensions (in)				Wt. (lbs)*
		A	B	C	D	
S1500X	RTE15X	27.80	5.98	25.04	2.28	10.1
S3000X	RTE30X	28.86	5.98	25.47	2.24	12.1
S6000X	RTE60X	29.41	5.98	25.94	2.56	17.0
S11000X	RTE110X	30.28	5.98	26.57	2.99	24.7
S25000X	RTE250X	32.01	5.98	26.97	3.94	38.1

* Weights indicated are for the accessories only and do not include the wrench.

SRSX-Series, Extended Reaction Arms

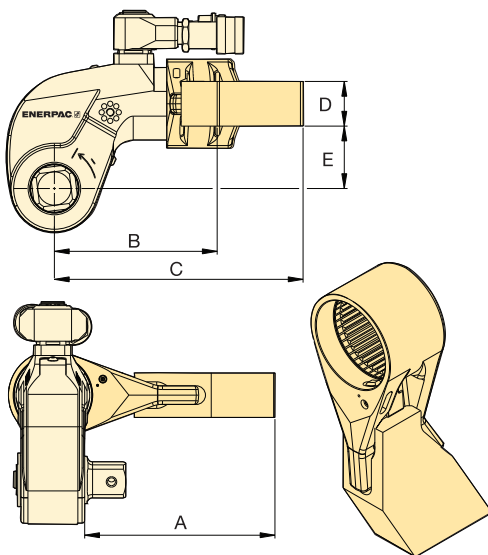

SRSX Series

- Lightweight interchangeable design

Wrench Model	Max. Torque (Ft-lbs)	Model Number	Dimensions (in)					Wt. (lbs)*
			A	B	C	D	E	
S1500X	1328	SRS151X	3.70	3.39	5.00	0.94	1.34	1.8
	1210	SRS152X	4.69	3.82	5.43	0.94	1.34	2.2
	1131	SRS153X	5.71	4.29	5.83	0.94	1.34	2.6
S3000X	2890	SRS301X	4.37	4.17	6.61	1.34	1.89	3.5
	2739	SRS302X	5.39	4.61	7.17	1.34	1.89	4.4
	2638	SRS303X	6.38	5.20	7.80	1.34	1.89	5.5
S6000X	5784	SRS601X	5.43	5.04	7.56	1.54	2.44	5.1
	5501	SRS602X	6.42	5.67	8.15	1.54	2.44	6.0
	5295	SRS603X	7.44	6.26	8.74	1.54	2.44	7.5
S11000X	10,812	SRS1101X	5.87	6.18	9.13	1.81	2.99	9.7
	10,300	SRS1102X	6.89	6.77	9.72	1.81	2.99	11.2
	9883	SRS1103X	7.87	7.36	10.28	1.81	2.99	12.8
S25000X	24,751	SRS2501X	7.20	8.23	11.61	1.97	3.94	16.8
	23,652	SRS2502X	8.19	8.74	12.20	1.97	3.94	18.5
	22,694	SRS2503X	9.17	9.29	12.83	1.97	3.94	22.0

* Weights indicated are for the accessories only and do not include the wrench.

- Heavy-duty impact sockets
- Supplied with "Pin and Ring"

Hexagon Sizes:

**3/4 - 6 1/8 inch
(19 - 155 mm)**



IMPERIAL SOCKETS													
3/4" Square Drive		1" Square Drive				1 1/2" Square Drive				2 1/2" Square Drive			
Model Number	A/F (in)	Model Number	A/F (in)	Model Number	A/F (in)	Model Number	A/F (in)	Model Number	A/F (in)	Model Number	A/F (in)	Model Number	A/F (in)
BSH7519	3/4"	BSH1019	3/4"	BSH10231	2 5/16"	BSH15144	1 7/16"	BSH15281	2 13/16"	BSH25244	2 7/16"	BSH25419	4 3/16"
BSH75088	7/8"	BSH10088	7/8"	BSH10238	2 3/8"	BSH1538	1 1/2"	BSH15288	2 7/8"	BSH25250	2 1/2"	BSH25425	4 1/4"
BSH75094	15/16"	BSH10094	15/16"	BSH10244	2 7/16"	BSH15156	1 9/16"	BSH1575	2 15/16"	BSH2565	2 9/16"	BSH25110	4 5/16"
BSH7527	1 1/16"	BSH1027	1 1/16"	BSH10250	2 1/2"	BSH15163	1 5/8"	BSH15300	3"	BSH25263	2 5/8"	BSH25438	4 3/8"
BSH7530	1 3/16"	BSH1030	1 3/16"	BSH1065	2 9/16"	BSH1543	1 11/16"	BSH15306	3 1/16"	BSH25269	2 11/16"	BSH25450	4 1/2"
BSH75125	1 1/4"	BSH10125	1 1/4"	BSH10263	2 5/8"	BSH15175	1 3/4"	BSH15313	3 1/8"	BSH2570	2 3/4"	BSH25463	4 5/8"
BSH75131	1 5/16"	BSH10131	1 5/16"	BSH10269	2 11/16"	BSH1546	1 13/16"	BSH15319	3 3/16"	BSH25281	2 13/16"	BSH25475	4 3/4"
BSH7535	1 3/8"	BSH1035	1 3/8"	BSH1070	2 3/4"	BSH15188	1 7/8"	BSH15325	3 1/4"	BSH25288	2 7/8"	BSH25488	4 7/8"
BSH75144	1 7/16"	BSH10144	1 7/16"	BSH10281	2 13/16"	BSH15194	1 15/16"	BSH15338	3 3/8"	BSH2575	2 15/16"	BSH25500	5"
BSH7538	1 1/2"	BSH1038	1 1/2"	BSH10288	2 7/8"	BSH15200	2"	BSH15350	3 1/2"	BSH25300	3"	BSH25513	5 1/8"
BSH75156	1 9/16"	BSH10156	1 9/16"	BSH1075	2 15/16"	BSH15206	2 1/16"	BSH15363	3 5/8"	BSH25306	3 1/16"	BSH25519	5 3/16"
BSH75163	1 5/8"	BSH10163	1 5/8"	BSH10300	3"	BSH15213	2 1/8"	BSH1595	3 3/4"	BSH25313	3 1/8"	BSH25525	5 1/4"
BSH7543	1 11/16"	BSH1043	1 11/16"	BSH10306	3 1/16"	BSH15219	2 3/16"	BSH15388	3 7/8"	BSH25319	3 3/16"	BSH25538	5 3/8"
BSH75175	1 3/4"	BSH10175	1 3/4"	BSH10313	3 1/8"	BSH15225	2 1/4"	BSH15100	3 15/16"	BSH25325	3 1/4"	BSH25140	5 1/2"
BSH7546	1 13/16"	BSH1046	1 13/16"	BSH10319	3 3/16"	BSH15231	2 5/16"	BSH15400	4"	BSH25338	3 3/8"	BSH25575	5 3/4"
BSH75188	1 7/8"	BSH10188	1 7/8"	BSH10325	3 1/4"	BSH15238	2 3/8"	BSH15105	4 1/8"	BSH25350	3 1/2"	BSH25150	5 7/8"
BSH75194	1 15/16"	BSH10194	1 15/16"	BSH10338	3 3/8"	BSH15244	2 7/16"	BSH15419	4 3/16"	BSH25363	3 5/8"	BSH25600	6"
BSH75200	2"	BSH10200	2"	BSH10350	3 1/2"	BSH15250	2 1/2"	BSH15425	4 1/4"	BSH2595	3 3/4"	BSH25613	6 1/8"
		BSH10206	2 1/16"	BSH10363	3 5/8"	BSH1565	2 9/16"	BSH15110	4 5/16"	BSH25388	3 7/8"		
		BSH10213	2 1/8"	BSH1095	3 3/4"	BSH15263	2 5/8"	BSH15438	4 3/8"	BSH25100	3 15/16"		
		BSH10219	2 3/16"	BSH10388	3 7/8"	BSH15269	2 11/16"	BSH15450	4 1/2"	BSH25400	4"		
		BSH10225	2 1/4"			BSH1570	2 3/4"	BSH15463	4 5/8"	BSH25105	4 1/8"		

METRIC SOCKETS							
3/4" Square Drive		1" Square Drive		1 1/2" Square Drive		2 1/2" Square Drive	
Model Number	A/F (mm)	Model Number	A/F (mm)	Model Number	A/F (mm)	Model Number	A/F (mm)
BSH7519	19	BSH1019	19	BSH1536	36	BSH2565	65
BSH7524	24	BSH1024	24	BSH15163	41	BSH2570	70
BSH7527	27	BSH1027	27	BSH1546	46	BSH2575	75
BSH7530	30	BSH1030	30	BSH1550	50	BSH2580	80
BSH7532	32	BSH1032	32	BSH1555	55	BSH2585	85
BSH7536	36	BSH1036	36	BSH1560	60	BSH2590	90
BSH75163	41	BSH10163	41	BSH1565	65	BSH2595	95
BSH7546	46	BSH1046	46	BSH1570	70	BSH25100	100
BSH7550	50	BSH1050	50	BSH1575	75	BSH25105	105
		BSH1055	55	BSH1580	80	BSH25110	110
		BSH1060	60	BSH1585	85	BSH25115	115
		BSH1065	65	BSH1590	90	BSH25120	120
		BSH1070	70	BSH1595	95	BSH25125	125
		BSH1075	75	BSH15100	100	BSH25135	135
		BSH1080	80	BSH15105	105	BSH25140	140
		BSH1085	85	BSH15110	110	BSH25145	145
		BSH1090	90	BSH15115	115	BSH25150	150
		BSH1095	95			BSH25155	155
		BSH10100	100				

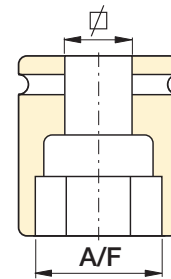

Pin and Ring

All sockets are supplied with a "Pin and Ring" to hold the socket in place on the square drive of the tool.



Select the Right Torque

Choose your Enerpac Torque Wrench using the untightening rule of thumb: Loosening torque equals about 250% of tightening torque.

ENERPAC professional series steel torque wrenches provide reliable controlled tightening solutions across many industries.

S3000X Square Drive Torque Wrench on Wind Turbine Assembly and Maintenance

S3000X used to connect wind turbine segments during assembly and maintenance. A robust but compact solution is required for bolt tightening on wind tower sections. Large numbers of fasteners require precise application of torque to ensure joint integrity is achieved and maintained.

The Enerpac S-Series wrench offers simple and reliable operation while providing accurate and repeatable results.



W4000X Low Profile Torque Wrench on an API Pipe Flange

Throughout the Oil and Gas, Petrochemical and Processing Industries, pipeline joints, valves, pumps and machinery present challenges for controlled bolting.

The restricted access on this flange was easily overcome with an Enerpac W-Series Torque Wrench. The W Wrenches offer reliability and control, ensuring even and consistent torque is applied to all bolts.

S3000X on an Oil and Gas Flange

During maintenance, quick turnaround times are essential; S-Series wrenches provide a large angle of nut rotation per stroke, offering speed and accuracy in a compact ergonomic tool.



▼ Shown: W4206X cassette with W4000X drive unit
(Rear model shows optional straight handle)



Setting New Standards in Safety, Simplicity and Performance



Two Handle Styles

Robust angled positioning handles come standard with every W-Series (X-Edition) tool. Straight positioning handles designed for extreme limited access applications are available as accessories.

Compatible W-Series (X-Edition) wrenches	Angled positioning handles (standard)	Straight positioning handles (optional)
W2000X, W4000X	SWH6A	SWH6S
W8000X, W15000X	SWH10A	SWH10S
W22000X, W35000X	Supplied with an eyebolt handle (SWH10EA)	

Safety and Performance

- Superior strength to size ratio provides easy access to difficult to reach applications without sacrificing endurance
- 30° rotation angle and rapid return stroke provide fast operation
- Tough manifold design with added safety feature for enhanced operator safety

Simplicity

- Fast release drive unit enables rapid exchange of cassettes, no tools required and no pins to lose
- Includes robust handles which mount on both sides, and the tops of cassettes to allow for extra maneuverability
- Quick and easy disassembly for maintenance without special tools

Versatility

- Available with optional enhanced tilt and swivel TSP300 manifold for horizontal and vertical maneuverability, with greater durability*
- X-Edition drive units, cassettes and most accessories are compatible with standard edition tools*
- Drive unit compatible with UltraSlim and WCR-Series cassettes

Accuracy

- Constant torque output provides accuracy of +/-3% across full stroke

* TSP300 is designed for X-Edition tools only, and is not compatible with standard edition tools. For replacement components for existing tools, refer to repair sheet on www.enerpac.com



TSP - Pro Series Swivel

The optional TSP300 tilt and swivel manifold with robust interlocking design provides 360° X-axis rotation and 160° Y-axis rotation.

How to Order

Factory fitted to new W-Series (X-Edition) wrenches: Insert a "P" prior to the "X" in the tool designation, e.g.: **W2000PX**.

Order as an accessory using the part number: **TSP300**, which can be fitted to existing W-Series (X-Edition) wrenches.

Page: 225

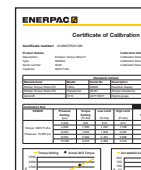

Calibration Certificate

All X-Edition tools are CE-ATEX declared, factory calibrated and are shipped complete with a calibration certificate.

  II 2 GD ck T4
CSA/SIRA 15XT072

W-Series, X-Edition Hexagon Wrenches

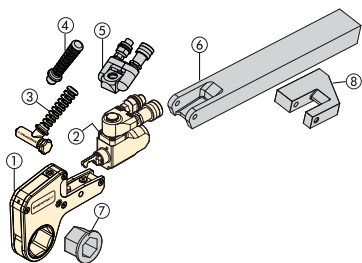

Hexagon Cassettes and Reducer Inserts

Full range of interchangeable hexagon cassettes and reducing inserts provides maximum versatility. Details available at www.enerpac.com

- ① Hexagon Cassette
- ② Drive Unit
- ③ Angled Positioning Handle
- ④ Straight Positioning Handle (optional)
- ⑤ Pro Series Swivel (optional)
- ⑥ Extended Reaction Arm (optional)
- ⑦ Reducer Insert (optional)
- ⑧ Reaction Paddle (optional)

DRIVE UNIT AND INTERCHANGEABLE CASSETTE SELECTION

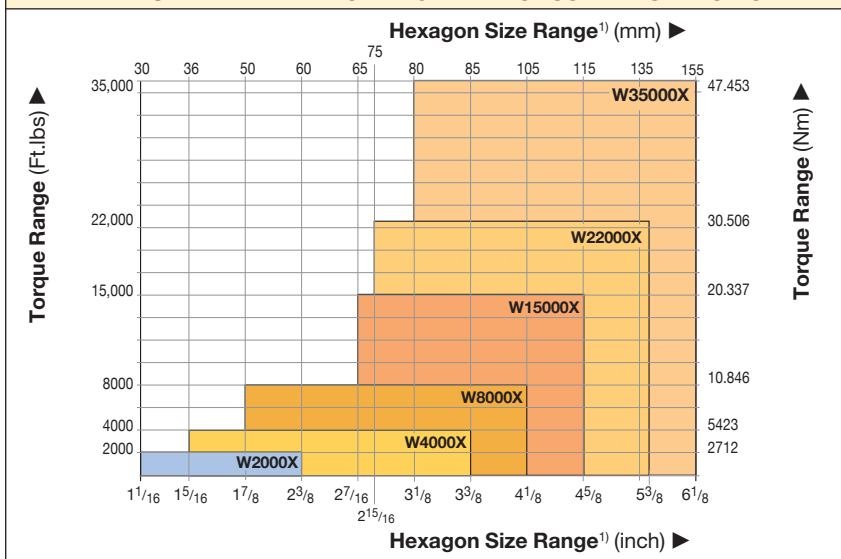

¹⁾ See page 285 for table of hexagon sizes of bolts, nuts and related thread diameters.

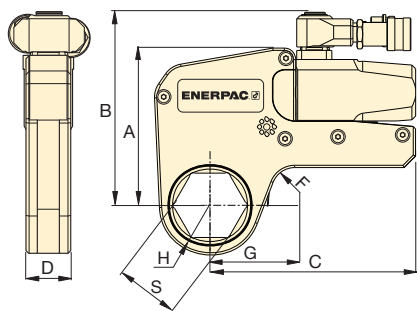

SELECTION CHART

Hexagon Range *	Nominal Torque at 10,000 psi		Drive Unit Model Number **	Minimum Torque		Dimensions (see pages 214-221 for dimensions H, G, and S)					Weight (Drive unit without hexagon cassette)	
	(in)	(mm)		(Ft.lbs)	(Nm)	(Ft.lbs)	(Nm)	(in)	A	B		C
1 1/16 - 2 3/8	30 - 60	2040	2766	W2000X	204	277	4.29	5.55	5.83	1.26	.79	3.04
1 5/16 - 3 3/8	36 - 85	4175	5661	W4000X	418	566	5.35	6.57	7.01	1.61	.79	4.44
1 7/8 - 4 1/8	50 - 105	8470	11,484	W8000X	847	1148	6.77	8.07	8.19	2.07	.98	6.59
2 7/16 - 4 5/8	65 - 115	15,330	20,785	W15000X	1533	2079	8.15	9.45	9.96	2.48	.79	10.72
2 15/16 - 5 3/8	75 - 135	22,500	30,506	W22000X	2250	3050	8.94	10.46	11.68	3.03	1.38	16.98
3 1/8 - 6 1/8	80-155	35,000	47,453	W35000X	3500	4745	10.54	11.94	13.60	3.57	1.98	26.40

* With in-line reaction foot.

** To order a W-series (X-Edition) wrench fitted with the TSP swivel, insert a "P" prior to the "X" in the tool designation. e.g., W2000PX.

W Series (X-Edition)



Nominal Torque at 10,000 psi:

35,000 Ft.lbs

Hexagon Range:

1 1/16 - 6 1/8 inch

Nose Radius:

1.22-4.52 inch

Maximum Operating Pressure:

10,000 psi



Torque Wrench Pump Selection Matrix

For optimum speed and performance see the torque wrench and pump matrix.

Page: **232**

▼ These rigid steel wrenches with low profile interchangeable hexagon cassettes guarantee durability and maximum versatility in bolting applications.



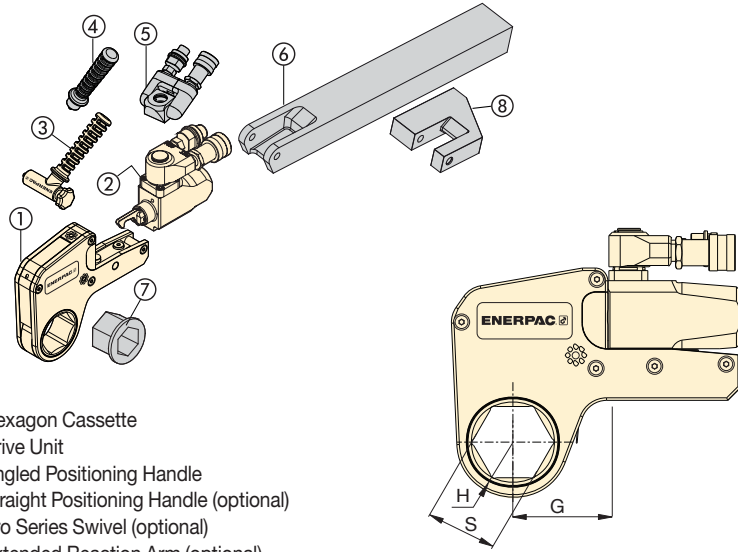

- ① Hexagon Cassette
- ② Drive Unit
- ③ Angled Positioning Handle
- ④ Straight Positioning Handle (optional)
- ⑤ Pro Series Swivel (optional)
- ⑥ Extended Reaction Arm (optional)
- ⑦ Reducer Insert (optional)
- ⑧ Reaction Paddle (optional)

W Series (X-Edition)



Nominal Torque at 10,000 psi:
2040 Ft.lbs

Hexagon Range:
1¹/₁₆ - 2³/₈ inch

Maximum Operating Pressure:
10,000 psi







Metric Sizes

For metric sizes of hexagon cassettes and reducer inserts see:

Page: **220**

▼ SELECTION CHART

Drive Unit Model Number	Hexagon Size	Nose Radius	Dim.	Model Number	Weight						
						Hexagon Reducer (in)	Model Number	Hexagon Reducer (in)	Model Number	Hexagon Reducer (in)	Model Number
W2000X	S (in)	H (in)	G (in)		(lbs)						
	1 ¹ / ₁₆	1.22	2.11	W2101X	4.19	-	-	-	-	-	-
	1 ¹ / ₈	1.22	2.11	W2102X	4.19	-	-	-	-	-	-
	1 ³ / ₁₆	1.22	2.11	W2103X	4.19	-	-	-	-	-	-
	1 ¹ / ₄	1.22	2.11	W2104X	4.19	-	-	-	-	-	-
	1 ⁵ / ₁₆	1.22	2.11	W2105X	4.48	-	-	-	-	-	-
	1 ³ / ₈	1.22	2.11	W2106X	4.43	-	-	-	-	-	-
	1 ⁷ / ₁₆	1.22	2.11	W2107X	4.37	1 ⁷ / ₁₆ - 1 ¹ / ₈	W2107R102	-	-	-	-
	1 ¹ / ₂	1.32	2.29	W2108X	4.51	-	-	-	-	-	-
	1 ⁹ / ₁₆	1.32	2.29	W2109X	4.44	-	-	-	-	-	-
	1 ⁵ / ₈	1.32	2.29	W2110X	4.38	1 ⁵ / ₈ - 1 ¹ / ₄	W2110R104	1 ⁵ / ₈ - 1 ³ / ₁₆	W2110R103	-	-
	1 ¹¹ / ₁₆	1.44	2.38	W2111X	4.63	-	-	-	-	-	-
	1 ³ / ₄	1.44	2.38	W2112X	4.57	-	-	-	-	-	-
	1 ¹³ / ₁₆	1.44	2.38	W2113X	4.46	1 ¹³ / ₁₆ - 1 ⁷ / ₁₆	W2113R107	1 ¹³ / ₁₆ - 1 ¹ / ₄	W2113R104	-	-
	1 ⁷ / ₈	1.54	2.48	W2114X	4.69	-	-	-	-	-	-
	1 ¹⁵ / ₁₆	1.54	2.48	W2115X	4.64	-	-	-	-	-	-
	2	1.54	2.48	W2200X	4.54	2 - 1 ⁵ / ₈	W2200R110	2 - 1 ⁷ / ₁₆	W2200R107	-	-
	2 ¹ / ₁₆	1.65	2.70	W2201X	4.83	-	-	-	-	-	-
	2 ¹ / ₈	1.65	2.70	W2202X	4.74	-	-	-	-	-	-
	2 ³ / ₁₆	1.65	2.70	W2203X	4.64	2 ³ / ₁₆ - 1 ¹³ / ₁₆	W2203R113	2 ³ / ₁₆ - 1 ⁵ / ₈	W2203R110	2 ³ / ₁₆ - 1 ⁷ / ₁₆	W2203R107
	2 ¹ / ₄	1.75	2.55	W2204X	4.94	-	-	-	-	-	-
2 ⁵ / ₁₆	1.75	2.55	W2205X	4.84	-	-	-	-	-	-	
2 ³ / ₈	1.75	2.55	W2206X	4.72	2 ³ / ₈ - 2	W2206R200	2 ³ / ₈ - 1 ⁷ / ₈	W2206R114	2 ³ / ₈ - 1 ¹³ / ₁₆	W2206R113	
-	-	-	-	-	-	2 ³ / ₈ - 1 ¹ / ₂	W2206R108	2 ³ / ₈ - 1 ⁷ / ₁₆	W2206R107	2 ³ / ₈ - 1 ⁵ / ₈	W2206R110

W4000X Series Imperial Cassettes & Reducer Inserts

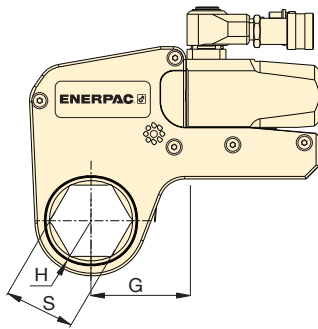

Nominal Torque at 10,000 psi:

4175 Ft.lbs

Hexagon Range:

1⁵/₁₆-3³/₈ inch

Maximum Operating Pressure:

10,000 psi

W
Series
(X-Edition)



▼ SELECTION CHART

Drive Unit Model Number	Hexagon Size	Nose Radius	Dim. G (in)	Model Number	Weight (lbs)	Hexagon Reducer		Hexagon Reducer		Hexagon Reducer	
						Hexagon Reducer (in)	Model Number	Hexagon Reducer (in)	Model Number	Hexagon Reducer (in)	Model Number
W4000X	1 ⁵ / ₁₆	1.46	2.40	W4105X	8.15	-	-	-	-	-	-
	1 ³ / ₈	1.46	2.40	W4106X	8.15	-	-	-	-	-	-
	1 ⁷ / ₁₆	1.46	2.40	W4107X	8.15	-	-	-	-	-	-
	1 ¹ / ₂	1.46	2.40	W4108X	8.31	-	-	-	-	-	-
	1 ⁹ / ₁₆	1.46	2.40	W4109X	8.22	-	-	-	-	-	-
	1 ⁵ / ₈	1.46	2.40	W4110X	8.15	-	-	-	-	-	-
	1 ¹¹ / ₁₆	1.56	2.52	W4111X	8.43	-	-	-	-	-	-
	1 ³ / ₄	1.56	2.52	W4112X	8.35	-	-	-	-	-	-
	1 ¹³ / ₁₆	1.56	2.52	W4113X	8.25	-	-	-	-	-	-
	1 ⁷ / ₈	1.63	2.63	W4114X	8.45	-	-	-	-	-	-
	1 ¹⁵ / ₁₆	1.63	2.63	W4115X	8.39	-	-	-	-	-	-
	2	1.63	2.63	W4200X	8.28	2 - 1 ⁷ / ₁₆	W4200R107	-	-	-	-
	2 ¹ / ₁₆	1.73	2.89	W4201X	8.65	-	-	-	-	-	-
	2 ¹ / ₈	1.73	2.89	W4202X	8.53	-	-	-	-	-	-
	2 ³ / ₁₆	1.73	2.89	W4203X	8.42	2 ³ / ₁₆ - 1 ⁵ / ₈	W4203R110	2 ³ / ₁₆ - 1 ⁷ / ₁₆	W4203R107	2 ³ / ₁₆ - 1 ¹ / ₄	W4203R104
	2 ¹ / ₄	1.83	2.78	W4204X	8.73	-	-	-	-	-	-
	2 ⁵ / ₁₆	1.83	2.78	W4205X	8.61	-	-	-	-	-	-
	2 ³ / ₈	1.83	2.78	W4206X	8.47	2 ³ / ₈ - 2	W4206R200	2 ³ / ₈ - 1 ¹³ / ₁₆	W4206R113	2 ³ / ₈ - 1 ⁷ / ₁₆	W4206R107
	-	-	-	-	-	2 ³ / ₈ - 1 ³ / ₈	W4206R106	-	-	-	-
	2 ⁷ / ₁₆	1.95	3.00	W4207X	8.96	2 ⁷ / ₁₆ - 2	W4207R200	-	-	-	-
	2 ¹ / ₂	1.95	3.00	W4208X	8.86	2 ¹ / ₂ - 2	W4208R200	2 ¹ / ₂ - 1 ¹³ / ₁₆	W4208R113	2 ¹ / ₂ - 2 ¹ / ₁₆	W4208R201
	2 ⁹ / ₁₆	1.95	3.00	W4209X	8.67	2 ⁹ / ₁₆ - 2 ³ / ₁₆	W4209R203	2 ⁹ / ₁₆ - 2 ¹ / ₈	W4209R202	-	-
	-	-	-	-	-	2 ⁹ / ₁₆ - 2	W4209R200	2 ⁹ / ₁₆ - 1 ¹³ / ₁₆	W4209R113	-	-
	2 ⁵ / ₈	2.07	3.08	W4210X	9.14	-	-	-	-	-	-
	2 ¹¹ / ₁₆	2.07	3.08	W4211X	9.03	-	-	-	-	-	-
	2 ³ / ₄	2.07	3.08	W4212X	8.84	2 ³ / ₄ - 2 ³ / ₈	W4212R206	2 ³ / ₄ - 2 ³ / ₁₆	W4212R203	2 ³ / ₄ - 2 ¹ / ₈	W4212R202
	2 ¹³ / ₁₆	2.18	3.21	W4213X	9.32	-	-	-	-	-	-
	2 ⁷ / ₈	2.18	3.21	W4214X	9.17	-	-	-	-	-	-
	2 ¹⁵ / ₁₆	2.18	3.21	W4215X	8.96	2 ¹⁵ / ₁₆ - 2 ⁹ / ₁₆	W4215R209	2 ¹⁵ / ₁₆ - 2 ³ / ₈	W4215R206	2 ¹⁵ / ₁₆ - 2 ³ / ₁₆	W4215R203
	-	-	-	-	-	2 ¹⁵ / ₁₆ - 2	W4215R200	-	-	-	-
	3	2.30	3.29	W4300X	9.51	3 - 2 ³ / ₁₆	W4300R203	-	-	-	-
	3 ¹ / ₁₆	2.30	3.29	W4301X	9.42	-	-	-	-	-	-
	3 ¹ / ₈	2.30	3.29	W4302X	9.16	-	-	3 ¹ / ₈ - 2 ³ / ₄	W4302R212	3 ¹ / ₈ - 2 ⁹ / ₁₆	W4302R209
	-	-	-	-	-	3 ¹ / ₈ - 2 ³ / ₈	W4302R206	3 ¹ / ₈ - 2 ⁵ / ₁₆	W4302R205	3 ¹ / ₈ - 2 ¹ / ₄	W4302R204
	-	-	-	-	-	3 ¹ / ₈ - 2 ³ / ₁₆	W4302R203	3 ¹ / ₈ - 2 ¹ / ₈	W4302R202	3 ¹ / ₈ - 2	W4302R200
	3 ³ / ₁₆	2.44	3.37	W4303X	9.92	-	-	-	-	-	-
3 ¹ / ₄	2.44	3.37	W4304X	9.92	-	-	-	-	-	-	
3 ⁵ / ₁₆	2.44	3.37	W4305X	9.92	-	-	-	-	-	-	
3 ³ / ₈	2.44	3.37	W4306X	9.92	-	-	-	-	-	-	

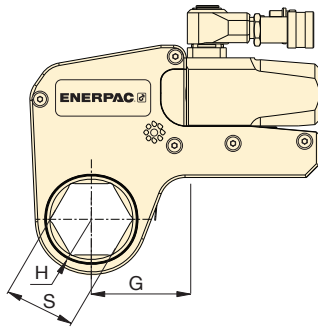

Nominal Torque at 10,000 psi:

8470 Ft.lbs

Hexagon Range:

1 7/8 - 4 1/8 inch





Maximum Operating Pressure:

10,000 psi

W
Series
(X-Edition)



▼ SELECTION CHART

Drive Unit Model Number	Hexagon Size	Nose Radius	Dim.	Model Number	Weight						
						Hexagon Reducer	Model Number	Hexagon Reducer	Model Number	Hexagon Reducer	Model Number
	S (in)	H (in)	G (in)		(lbs)	(in)		(in)		(in)	
W8000X	1 7/8	1.77	3.08	W8114X	17.97	-	-	-	-	-	-
	1 15/16	1.77	3.08	W8115X	17.89	-	-	-	-	-	-
	2	1.77	3.08	W8200X	17.75	-	-	-	-	-	-
	2 1/16	1.89	3.15	W8201X	17.52	-	-	-	-	-	-
	2 1/8	1.89	3.15	W8202X	17.36	-	-	-	-	-	-
	2 3/16	1.89	3.15	W8203X	17.22	-	-	-	-	-	-
	2 1/4	2.01	3.25	W8204X	17.92	-	-	-	-	-	-
	2 5/16	2.01	3.25	W8205X	17.76	-	-	-	-	-	-
	2 3/8	2.01	3.25	W8206X	17.59	-	-	-	-	-	-
	2 7/16	2.07	3.38	W8207X	17.65	-	-	-	-	-	-
	2 1/2	2.07	3.38	W8208X	17.52	-	-	-	-	-	-
	2 9/16	2.07	3.38	W8209X	17.29	2 9/16 - 2	W8209R200	-	-	-	-
	2 5/8	2.20	3.34	W8210X	17.50	-	-	-	-	-	-
	2 11/16	2.20	3.34	W8211X	17.36	-	-	-	-	-	-
	2 3/4	2.20	3.34	W8212X	17.12	2 3/4 - 2 3/16	W8212R203	-	-	-	-
	2 13/16	2.28	3.35	W8213X	17.57	-	-	-	-	-	-
	2 7/8	2.28	3.35	W8214X	17.38	-	-	-	-	-	-
	2 15/16	2.28	3.35	W8215X	17.11	2 15/16 - 2 3/8	W8215R206	2 15/16 - 2 3/8	W8215R203	-	-
	3	2.38	3.52	W8300X	17.77	-	-	-	-	-	-
	3 1/16	2.38	3.52	W8301X	17.65	-	-	-	-	-	-
	3 1/8	2.38	3.52	W8302X	17.33	3 1/8 - 2 9/16	W8302R209	3 1/8 - 2 9/16	W8302R206	3 1/8 - 2 3/16	W8302R203
	-	-	-	-	-	-	3 1/8 - 2	W8302R200	-	-	-
	3 3/16	2.60	3.63	W8303X	18.99	-	-	-	-	-	-
	3 1/4	2.60	3.63	W8304X	18.72	-	-	-	-	-	-
	3 5/16	2.60	3.63	W8305X	18.54	-	-	-	-	-	-
	3 3/8	2.60	3.63	W8306X	18.36	-	-	-	-	-	-
	3 7/16	2.60	3.63	W8307IX	18.11	-	-	-	-	-	-
	3 1/2	2.60	3.63	W8308X	17.81	3 1/2 - 3	W8308R300	3 1/2 - 2 15/16	W8308R215	3 1/2 - 2 3/4	W8308R212
	3 9/16	2.91	4.05	W8309X	20.36	-	-	-	-	-	-
	3 5/8	2.91	4.05	W8310X	20.18	-	-	-	-	-	-
	3 11/16	2.91	4.05	W8311X	19.93	-	-	-	-	-	-
	3 3/4	2.91	4.05	W8312X	19.71	3 3/4 - 3 1/8	W8312R302	3 3/4 - 2 15/16	W8312R215	3 3/4 - 2 3/4	W8312R212
3 13/16	2.91	4.05	W8313X	19.46	-	-	-	-	-	-	
3 7/8	2.91	4.05	W8314X	19.10	3 7/8 - 3 1/8	W8314R302	3 7/8 - 2 15/16	W8314R215	-	-	
3 15/16	3.13	4.33	W8315X	20.31	-	-	-	-	-	-	
4	3.13	4.33	W8400X	20.04	-	-	-	-	-	-	
4 1/16	3.13	4.33	W8401IX	19.80	-	-	-	-	-	-	
4 1/8	3.13	4.33	W8402X	19.39	-	-	-	-	-	-	

W15000X Series Imperial Cassettes & Reducer Inserts

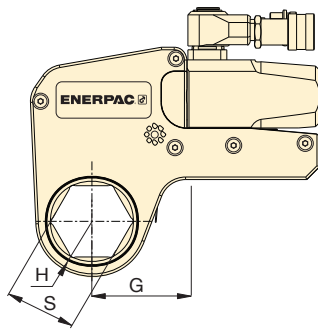

Nominal Torque at 10,000 psi:

15,330 Ft.lbs

Hexagon Range:

2⁷/₁₆-4⁵/₈ inch

Maximum Operating Pressure:

10,000 psi

W
Series
(X-Edition)



▼ SELECTION CHART

Drive Unit Model Number	Hexagon Size	Nose Radius	Dim. G	Model Number	Weight (lbs)	Hexagon Reducer		Hexagon Reducer		Hexagon Reducer	
						Hexagon Reducer (in)	Model Number	Hexagon Reducer (in)	Model Number	Hexagon Reducer (in)	Model Number
W15000X	S	H	G								
	2 ⁷ / ₁₆	2.32	3.49	W15207X	30.72	-	-	-	-	-	-
	2 ¹ / ₂	2.32	3.49	W15208X	30.72	-	-	-	-	-	-
	2 ⁹ / ₁₆	2.32	3.49	W15209X	30.72	-	-	-	-	-	-
	2 ⁵ / ₈	2.32	3.49	W15210X	30.72	-	-	-	-	-	-
	2 ¹¹ / ₁₆	2.32	3.49	W15211X	30.72	-	-	-	-	-	-
	2 ³ / ₄	2.32	3.49	W15212X	30.72	-	-	-	-	-	-
	2 ¹³ / ₁₆	2.44	3.56	W15213X	30.62	-	-	-	-	-	-
	2 ⁷ / ₈	2.44	3.56	W15214X	30.39	-	-	-	-	-	-
	2 ¹⁵ / ₁₆	2.44	3.56	W15215X	30.08	-	-	-	-	-	-
	3	2.54	3.66	W15300X	30.86	3 - 2 ¹ / ₈	W15300R202	-	-	-	-
	3 ¹ / ₁₆	2.54	3.66	W15301X	30.71	-	-	-	-	-	-
	3 ¹ / ₈	2.54	3.66	W15302X	30.34	3 ¹ / ₈ - 2 ⁹ / ₁₆	W15302R209	-	-	-	-
	3 ³ / ₁₆	2.74	3.80	W15303X	32.38	-	-	-	-	-	-
	3 ¹ / ₄	2.74	3.80	W15304X	32.07	-	-	-	-	-	-
	3 ⁵ / ₁₆	2.74	3.80	W15305X	31.85	-	-	-	-	-	-
	3 ³ / ₈	2.74	3.80	W15306X	31.63	-	-	-	-	-	-
	3 ⁷ / ₁₆	2.74	3.80	W15307IX	31.32	-	-	-	-	-	-
	3 ¹ / ₂	2.74	3.80	W15308X	30.98	3 ¹ / ₂ - 2 ¹⁵ / ₁₆	W15308R215	3 ¹ / ₂ - 2 ³ / ₄	W15308R212	-	-
	3 ⁹ / ₁₆	2.95	4.01	W15309X	31.70	-	-	-	-	-	-
	3 ⁵ / ₈	2.95	4.01	W15310X	31.70	-	-	-	-	-	-
	3 ¹¹ / ₁₆	2.95	4.01	W15311X	31.70	-	-	-	-	-	-
	3 ³ / ₄	2.95	4.01	W15312X	31.70	3 ³ / ₄ - 3 ¹ / ₈	W15312R302	3 ³ / ₄ - 2 ¹⁵ / ₁₆	W15312R215	-	-
	3 ¹³ / ₁₆	2.95	4.01	W15313X	31.70	-	-	-	-	-	-
	3 ⁷ / ₈	2.95	4.01	W15314X	31.70	3 ⁷ / ₈ - 3 ¹ / ₈	W15314R302	3 ⁷ / ₈ - 2 ¹⁵ / ₁₆	W15314R215	-	-
	3 ¹⁵ / ₁₆	3.17	4.06	W15315X	34.02	-	-	-	-	-	-
	4	3.17	4.06	W15400X	33.70	-	-	-	-	-	-
	4 ¹ / ₁₆	3.17	4.06	W15401IX	33.41	-	-	-	-	-	-
	4 ¹ / ₈	3.17	4.06	W15402X	33.09	4 ¹ / ₈ - 3 ¹ / ₂	W15402R308	4 ¹ / ₈ - 3 ⁵ / ₁₆	W15402R305	4 ¹ / ₈ - 3 ¹ / ₄	W15402R304
	4 ³ / ₁₆	3.17	4.06	W15403IX	32.81	-	-	-	-	-	-
	4 ¹ / ₄	3.17	4.06	W15404X	32.29	4 ¹ / ₄ - 3 ¹ / ₂	W15404R308	4 ¹ / ₄ - 3 ¹ / ₈	W15404R302	-	-
	4 ⁵ / ₁₆	3.44	4.52	W15405X	35.61	-	-	-	-	-	-
4 ³ / ₈	3.44	4.52	W15406X	35.32	-	-	-	-	-	-	
4 ⁷ / ₁₆	3.44	4.52	W15407X	34.99	-	-	-	-	-	-	
4 ¹ / ₂	3.44	4.52	W15408IX	34.63	-	-	-	-	-	-	
4 ⁹ / ₁₆	3.44	4.52	W15409IX	34.28	-	-	-	-	-	-	
4 ⁵ / ₈	3.44	4.52	W15410IX	33.72	4 ⁵ / ₈ - 3 ¹⁵ / ₁₆	W15410R315	4 ⁵ / ₈ - 3 ⁷ / ₈	W15410R314	4 ⁵ / ₈ - 3 ³ / ₄	W15410R312	
-	-	-	-	-	-	4 ⁵ / ₈ - 3 ¹ / ₂	W15410R308	-	-	-	

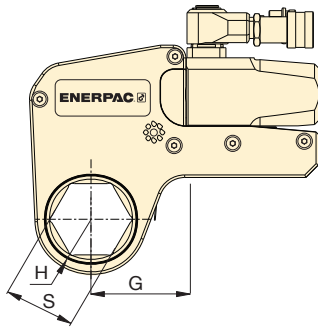

Nominal Torque at 10,000 psi:

22,500 Ft.lbs

Hexagon Range:

2¹⁵/₁₆ - 5³/₈ inch





Maximum Operating Pressure:

10,000 psi

W
Series
(X-Edition)





▼ SELECTION CHART

Drive Unit Model Number	Hexagon Size	Nose Radius	Dim.	Model Number	Weight						
						Hexagon Reducer (in)	Model Number	Hexagon Reducer (in)	Model Number	Hexagon Reducer (in)	Model Number
W22000X	S (in)	H (in)	G (in)		(lbs)						
	2 ¹⁵ / ₁₆	2.64	4.02	W22215X	48.72	-	-	-	-	-	-
	3	2.64	4.02	W22300X	48.40	-	-	-	-	-	-
	3 ¹ / ₁₆	2.64	4.02	W22301X	48.22	-	-	-	-	-	-
	3 ¹ / ₈	2.64	4.02	W22302X	47.78	3 ¹ / ₈ - 2 ³ / ₈	W22302R206	3 ¹ / ₈ - 2 ³ / ₁₆	W22302R203	-	-
	3 ³ / ₁₆	2.85	4.23	W22303X	50.58	-	-	-	-	-	-
	3 ¹ / ₄	2.85	4.23	W22304X	50.19	-	-	-	-	-	-
	3 ⁵ / ₁₆	2.85	4.23	W22305X	49.92	-	-	-	-	-	-
	3 ³ / ₈	2.85	4.23	W22306X	49.66	-	-	-	-	-	-
	3 ⁷ / ₁₆	2.85	4.23	W22307X	50.29	-	-	-	-	-	-
	3 ¹ / ₂	2.85	4.23	W22308X	48.87	3 ¹ / ₂ - 2 ³ / ₄	W22308R212	3 ¹ / ₂ - 2 ⁹ / ₁₆	W22308R209	3 ¹ / ₂ - 2 ³ / ₈	W22308R206
	3 ⁹ / ₁₆	3.07	4.45	W22309X	51.58	-	-	-	-	-	-
	3 ⁵ / ₈	3.07	4.45	W22310X	51.30	-	-	-	-	-	-
	3 ¹¹ / ₁₆	3.07	4.45	W22311X	50.93	-	-	-	-	-	-
	3 ³ / ₄	3.07	4.45	W22312X	50.62	3 ³ / ₄ - 2 ¹⁵ / ₁₆	W22312R215	-	-	-	-
	3 ¹³ / ₁₆	3.07	4.45	W22313X	50.24	-	-	-	-	-	-
	3 ⁷ / ₈	3.07	4.45	W22314X	49.77	3 ⁷ / ₈ - 3 ¹ / ₈	W22314R302	3 ⁷ / ₈ - 2 ¹⁵ / ₁₆	W22314R215	3 ⁷ / ₈ - 2 ³ / ₄	W22314R212
	3 ¹⁵ / ₁₆	3.35	4.72	W22315X	53.57	-	-	-	-	-	-
	4	3.35	4.72	W22400X	53.19	-	-	-	-	-	-
	4 ¹ / ₁₆	3.35	4.72	W22401IX	52.82	-	-	-	-	-	-
	4 ¹ / ₈	3.35	4.72	W22402X	52.43	-	-	-	-	-	-
	4 ³ / ₁₆	3.35	4.72	W22403X	52.09	-	-	-	-	-	-
	4 ¹ / ₄	3.35	4.72	W22404X	51.48	4 ¹ / ₄ - 3 ¹ / ₂	W22404R308	4 ¹ / ₄ - 3 ¹ / ₈	W22404R302	4 ¹ / ₄ - 2 ¹⁵ / ₁₆	W22404R215
	4 ⁵ / ₁₆	3.54	4.92	W22405X	54.26	-	-	-	-	-	-
	4 ³ / ₈	3.54	4.92	W22406X	53.91	-	-	-	-	-	-
	4 ⁷ / ₁₆	3.54	4.92	W22407X	53.50	-	-	-	-	-	-
	4 ¹ / ₂	3.54	4.92	W22408IX	53.06	-	-	-	-	-	-
	4 ⁹ / ₁₆	3.54	4.92	W22409X	52.64	-	-	-	-	-	-
	4 ⁵ / ₈	3.54	4.92	W22410IX	51.99	4 ⁵ / ₈ - 3 ⁷ / ₈	W22410R314	4 ⁵ / ₈ - 3 ³ / ₄	W22410R312	4 ⁵ / ₈ - 3 ¹ / ₂	W22410R308
	4 ³ / ₄	3.74	5.12	W22412X	54.54	-	-	-	-	-	-
4 ⁷ / ₈	3.74	5.12	W22414X	53.60	-	-	-	-	-	-	
5	3.74	5.12	W22500X	52.37	5 - 4 ¹ / ₄	W22500R404	5 - 4 ¹ / ₈	W22500R402	5 - 3 ⁷ / ₈	W22500R314	
5 ¹ / ₈	3.94	5.31	W22502X	55.10	-	-	-	-	-	-	
5 ¹ / ₁₆	3.94	5.31	W22503X	54.71	-	-	-	-	-	-	
5 ¹ / ₄	3.94	5.31	W22504X	54.05	-	-	-	-	-	-	
5 ³ / ₈	3.94	5.31	W22506X	52.77	5 ³ / ₈ - 4 ⁵ / ₈	W22506R410	5 ³ / ₈ - 4 ¹ / ₄	W22506R404	5 ³ / ₈ - 4 ¹ / ₈	W22506R402	
-	-	-	W22506X	52.77	5 ³ / ₈ - 3 ⁷ / ₈	W22506R314	-	-	-	-	

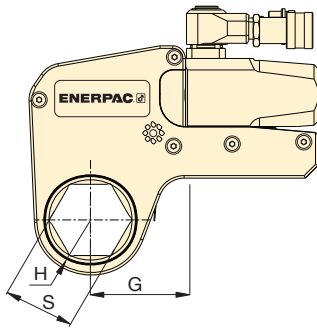
W35000X Series Imperial Cassettes & Reducer Inserts



▼ SELECTION CHART

Drive Unit Model Number	Hexagon Size	Nose Radius	Dim.	Model Number	Weight		
						Hexagon Reducer	Model Number
	S (in)	H (in)	G (in)		(lbs)	(in)	
W35000X	3 ¹ / ₈	3.02	4.99	W35302X	72.30	3 ¹ / ₈ - 2	W35302R200
	3 ³ / ₁₆	3.02	4.99	W35303X	72.10	-	-
	3 ¹ / ₄	3.02	4.99	W35304X	71.70	-	-
	3 ⁵ / ₁₆	3.02	4.99	W35305X	71.40	-	-
	3 ³ / ₈	3.02	4.99	W35306X	71.00	-	-
	3 ⁷ / ₁₆	3.02	4.99	W35307IX	70.50	-	-
	3 ¹ / ₂	3.02	4.99	W35308X	70.10	3 ¹ / ₂ - 2 ⁵ / ₁₆	W35308R205
	3 ⁹ / ₁₆	3.23	5.22	W35309X	71.40	-	-
	3 ⁵ / ₈	3.23	5.22	W35310X	73.40	-	-
	3 ¹¹ / ₁₆	3.23	5.22	W35311X	73.00	-	-
	3 ³ / ₄	3.23	5.22	W35312X	72.50	-	-
	3 ¹³ / ₁₆	3.23	5.22	W35313X	72.10	-	-
	3 ⁷ / ₈	3.23	5.22	W35314X	71.40	3 ⁷ / ₈ - 2 ¹¹ / ₁₆	W35314R211
	3 ¹⁵ / ₁₆	3.45	5.39	W35315X	70.80	3 ¹⁵ / ₁₆ - 2 ¹³ / ₁₆	W35315R213
	4	3.45	5.39	W35400X	74.70	-	-
	4 ¹ / ₁₆	3.45	5.39	W35401X	74.30	-	-
	4 ¹ / ₈	3.45	5.39	W35402X	73.90	-	-
	4 ³ / ₁₆	3.45	5.39	W35403X	73.40	-	-
	4 ¹ / ₄	3.45	5.39	W35404X	72.80	4 ¹ / ₄ - 3 ¹³ / ₁₆	W35404R301
	4 ⁵ / ₁₆	3.69	5.63	W35405X	76.90	-	-
	4 ³ / ₈	3.69	5.63	W35406X	76.50	-	-
	4 ⁷ / ₁₆	3.69	5.63	W35407X	76.10	-	-
	4 ¹ / ₂	3.69	5.63	W35408X	75.60	-	-
	4 ⁹ / ₁₆	3.69	5.63	W35409IX	75.20	-	-
	4 ⁵ / ₈	3.69	5.63	W35410IX	74.50	4 ⁵ / ₈ - 3 ⁵ / ₈	W35410R310
	4 ³ / ₄	3.91	5.85	W35412X	78.50	4 ³ / ₄ - 3 ³ / ₄	W35412R312
	4 ⁷ / ₈	3.91	5.85	W35414X	76.90	-	-
	5	3.91	5.85	W35500X	75.60	5 - 4	W35500R400
	5 ¹ / ₈	4.09	6.02	W35502X	78.90	5 ¹ / ₈ - 4 ¹ / ₈	W35502R402
	5 ³ / ₁₆	4.09	6.02	W35503X	78.50	-	-
	5 ¹ / ₄	4.09	6.02	W35504X	77.60	-	-
	5 ³ / ₈	4.09	6.02	W35506X	76.30	5 ³ / ₈ - 4 ⁵ / ₁₆	W35506R405
5 ¹ / ₂	4.31	6.24	W35508X	79.80	-	-	
5 ⁹ / ₁₆	4.31	6.24	W35509X	79.40	-	-	
5 ⁵ / ₈	4.31	6.24	W35510X	78.50	-	-	
5 ³ / ₄	4.31	6.24	W35512X	76.90	5 ³ / ₄ - 4 ³ / ₄	W35512R412	
5 ⁷ / ₈	4.52	6.46	W35514X	80.90	5 ⁷ / ₈ - 4 ⁷ / ₈	W35514R414	
6	4.52	6.46	W35600X	79.60	-	-	
6 ¹ / ₈	4.52	6.46	W35602X	77.80	6 ¹ / ₈ - 5 ¹ / ₈	W35602R502	

W Series (X-Edition)



Nominal Torque at 10,000 psi:

35,000 Ft.lbs

Hexagon Range:

3¹/₈-6¹/₈ inches

Maximum Operating Pressure:

10,000 psi

W-Series Metric Cassettes and Reducer Inserts

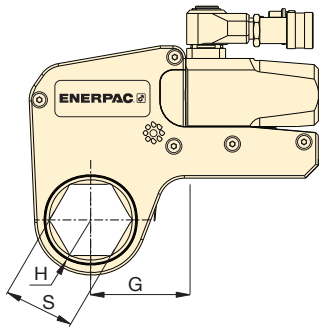





Hexagon Range:
30-105 mm

Maximum Operating Pressure:
10,000 psi (690 bar)

W
Series
(X-Edition)



▼ SELECTION CHART

Drive Unit Model Number	Hexagon Size	Nose Radius	Dim.	Model Number	Wt.							
						Hexagon Reducer	Model Number	Hexagon Reducer	Model Number	Hexagon Reducer	Model Number	
	S (mm)	H (in)	G (in)		(lbs)	(mm)		(mm)		(mm)		
W2000X	30	1.22	2.11	W2103X	4.19	-	-	-	-	-	-	
	32	1.22	2.11	W2104X	4.19	-	-	-	-	-	-	
	36	1.22	2.11	W2107X	4.19	-	-	-	-	-	-	
	38	1.32	2.29	W2108X	4.51	-	-	-	-	-	-	
	41	1.32	2.29	W2110X	4.38	41 - 32	W2110R104	41 - 30	W2110R103	41 - 24	W2110R024M	
	46	1.44	2.38	W2113X	4.69	46 - 36	W2113R107	46 - 32	W2113R104	-	-	
	50	1.54	2.48	W2200X	4.54	50 - 41	W2200R110	50 - 36	W2200R107	-	-	
	55	1.65	2.70	W2203X	4.64	55 - 46	W2203R113	55 - 41	W2203R110	55 - 36	W2203R107	
	60	1.75	2.55	W2206X	4.72	60 - 50	W2206R200	60 - 46	W2206R113	60 - 41	W2206R110	
-	-	-	-	-	-	60 - 36	W2206R107	-	-	-	-	
W4000X	36	1.46	2.40	W4107X	7.72	-	-	-	-	-	-	
	41	1.46	2.40	W4110X	7.72	-	-	-	-	-	-	
	46	1.56	2.52	W4113X	7.94	-	-	-	-	-	-	
	50	1.63	2.63	W4200X	8.28	50 - 36	W4200R107	-	-	-	-	
	55	1.73	2.89	W4203X	8.42	55 - 41	W4203R110	55 - 36	W4203R107	55 - 32	W4203R104	
	60	1.83	2.78	W4206X	8.47	60 - 50	W4206R200	60 - 46	W4206R113	60 - 36	W4206R107	
	65	1.95	3.00	W4209X	8.67	65 - 55	W4209R203	65 - 50	W4209R200	65 - 46	W4209R113	
	70	2.07	3.08	W4212X	8.84	70 - 60	W4212R206	70 - 55	W4212R203	-	-	
	75	2.18	3.21	W4215X	8.96	75 - 65	W4215R209	75 - 60	W4215R206	-	-	
	-	-	-	-	-	-	75 - 55	W4215R203	75 - 50	W4215R200	-	-
	80	2.30	3.29	W4302X	9.16	80 - 75	W4302R215	80 - 70	W4302R212	80 - 65	W4302R209	
	-	-	-	-	-	-	80 - 55	W4302R203	80 - 50	W4302R200	-	-
W8000X	50	1.77	3.08	W8200X	17.75	-	-	-	-	-	-	
	55	1.89	3.15	W8203X	17.22	-	-	-	-	-	-	
	60	2.01	3.25	W8206X	17.59	-	-	-	-	-	-	
	65	2.07	3.38	W8209X	17.29	65 - 50	W8209R200	-	-	-	-	
	70	2.07	3.34	W8212X	17.12	70 - 55	W8212R203	-	-	-	-	
	75	2.28	3.35	W8215X	17.11	75 - 60	W8215R206	75 - 55	W8215R203	-	-	
	80	2.38	3.52	W8302X	17.33	80 - 65	W8302R209	80 - 60	W8302R206	80 - 55	W8302R203	
	-	-	-	-	-	-	80 - 50	W8302R200	-	-	-	
	85	2.60	3.63	W8085MX	18.42	85 - 70	W8085R070M	85 - 65	W8085R065M	85 - 60	W8085R060M	
	-	-	-	-	-	-	85 - 55	W8085R055M	-	-	-	
	90	2.91	4.05	W8090MX	20.46	90 - 75	W8090R075M	-	-	-	-	
	95	2.91	4.05	W8312X	19.71	95 - 80	W8312R302	95 - 75	W8312R215	-	-	
	100	3.13	4.33	W8315X	20.31	-	-	-	-	-	-	
105	3.13	4.33	W8402X	19.39	-	-	-	-	-	-		

W-Series Metric Cassettes and Reducer Inserts

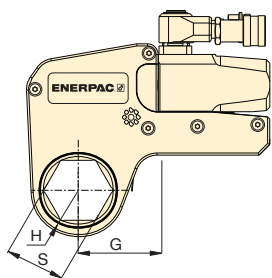

Hexagon Range:

65-155 mm

Maximum Operating Pressure:

10,000 psi (690 bar)

W
Series
(X-Edition)



▼ SELECTION CHART

Drive Unit Model Number	Hexagon Size	Nose Radius	Dim.	Model Number	Wt.	Hexagon Reducer		Hexagon Reducer	
						Hexagon Reducer (mm)	Model Number	Hexagon Reducer (mm)	Model Number
	S (mm)	H (in)	G (in)		(lbs)				
W15000X	65	2.32	3.49	W15209X	30.72	-	-	-	-
	70	2.32	3.49	W15212X	30.72	-	-	-	-
	75	2.44	3.56	W15215X	30.08	-	-	-	-
	80	2.54	3.66	W15302X	30.34	80-65	W15302R209	-	-
	85	2.74	3.80	W15085MX	31.70	85-70	W15085R070M	-	-
	90	2.95	4.01	W15090MX	33.32	90-75	W15090R075M	-	-
	95	2.95	4.01	W15312X	31.70	95-80	W15312R302	95 - 75	W15312R215
	100	3.17	4.06	W15315X	34.02	-	-	-	-
	105	3.17	4.06	W15402X	33.09	105-90	W15402R090M	-	-
	110	3.44	4.52	W15405X	35.61	110-95	W15110R095M	-	-
	115	3.44	4.52	W15115MX	34.48	115-100	W15115R100M	-	-
W22000X	75	2.64	4.02	W22215X	48.72	-	-	-	-
	80	2.64	4.02	W22302X	47.78	80-60	W22302R206	80 - 55	W22302R203
	85	2.85	4.23	W22085MX	49.74	85-65	W22085MR209	85 - 60	W22085MR206
	90	3.07	4.45	W22090MX	51.72	90-70	W22090M212	90 - 60	W22090MR206
	95	3.07	4.45	W22312X	50.62	95-75	W22312R215	-	-
	100	3.35	4.72	W22315X	53.57	-	-	-	-
	105	3.35	4.72	W22402X	52.09	-	-	-	-
	110	3.54	4.92	W22404X	51.48	-	-	-	-
	115	3.54	4.92	W22115MX	52.88	-	-	-	-
	120	3.74	5.12	W22412X	54.54	-	-	-	-
	123	3.74	5.12	W22123MX	53.80	-	-	-	-
130	3.94	5.31	W22502X	55.10	-	-	-	-	
135	3.94	5.31	W22506X	52.77	135 - 105	W22506R402	-	-	
W35000X	80	3.02	5.08	W35302X	72.30	80-50	W35302R200	-	-
	85	3.02	5.08	W35085MX	33.10	-	-	-	-
	90	3.23	5.33	W35090MX	34.30	90-60	W35090R206	-	-
	95	3.23	5.30	W35312X	72.50	-	-	-	-
	100	3.45	5.48	W35315X	70.80	-	-	-	-
	105	3.45	5.48	W35402X	73.90	-	-	-	-
	110	3.69	5.75	W35405X	76.90	110-85	W35405R085M	-	-
	115	3.69	5.75	W35115MX	77.10	-	-	-	-
	120	3.91	6.01	W35412X	78.50	120-95	W35412R312	-	-
	123	3.91	6.01	W35123MX	78.90	-	-	-	-
	130	4.09	6.30	W35502X	78.90	130-105	W35502R402	-	-
	135	4.09	6.30	W35506X	76.30	135-110	W35506R405	-	-
	140	4.31	6.43	W35508X	79.80	140-115	W35508R115M	-	-
	145	4.31	6.43	W35512X	76.90	145-120	W35512R412	-	-
	150	4.52	6.67	W35514X	80.90	-	-	-	-
151	4.52	6.67	W35151MX	82.10	-	-	-	-	
155	4.52	6.67	W35602X	77.80	155-130	W35602R502	-	-	

▼ Shown: W4206SL stepped-width cassette with W4000X drive unit



Your easy and long lasting solution to difficult access bolting applications



Designed for Tight Spots

Stepped width design provides easy access in confined areas. UltraSlim cassettes fit where standard solutions won't.



Built to Outperform

High endurance components keep working when others fail.



Top Mounted Handles

Standard top mounted handles provide safety and versatility; optional angled handles are also available.

Replacement handle (straight)	SWH6S
Angled handle (optional)	SWH6A

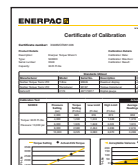

Calibration Certificate

All UltraSlim Series cassettes are CE - ATEX declared, factory calibrated and are shipped complete with a calibration certificate.

CE  II 2 GD ck T4
CSA/SIRA 15XT072

Versatility

- Lean, stepped width design allows tool to be mounted over bolts where other tools won't fit
- Bi-Hexagonal cassette allows twice as many positioning points on nut or bolt
- Uses same drive unit as standard W-series hexagon cassettes
- Robust top mounted handle stays out of the way, providing safe fastening in hard to reach areas

Performance

- Premium components provide best-in-class endurance

Ease of Use

- Few moving parts are easily accessible for quick field maintenance
- Fast release drive unit enables rapid exchange of cassettes, no tools required and no pins to lose
- Uses same drive unit as standard and X-Edition cassettes

Accuracy

- Constant torque output provides accuracy of +/- 3% across the full stroke

Slim enough to fit and tough enough to last. This UltraSlim wrench is the perfect controlled bolting solution for this oil and gas flange. ▶



UltraSlim Stepped-Width Cassettes



UltraSlim Stepped-Width Cassettes

Accessing narrow spaces normally requires significantly reducing the width of the torque wrench. For the tool operator, this has always meant vastly reduced tool durability, and/or reduced torque output.

By using the highest grade materials, perfecting the geometry, and placing the positioning handle on top of the tool, Enerpac UltraSlim cassettes are able to provide greater torque, get into tighter spaces, and vastly outperform the competition in product durability.*

Durability of Key Components*

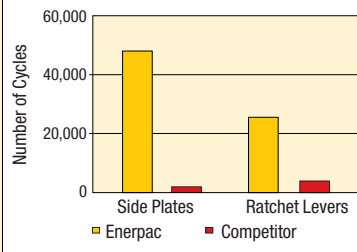

*Average test results, whereby three Enerpac 1³/₁₆" UltraSlim cassettes and three competitor 1³/₁₆" cassettes were tested at 4000 ft-lbs for 50,000 cycles. The Enerpac sideplates never broke for the full duration of the test.

W Series Ultra-Slim



Nominal Torque at 10,000 psi:

4360 Ft.lbs.

Hexagon Range:

1¹³/₁₆ - 2¹⁵/₁₆ inches

Maximum Operating Pressure:

10,000 psi



Torque Wrench Pumps

Visit enerpac.com for system matched air and electric torque wrench pumps that are ideal for use with hydraulic torque wrenches.

Page: 232



Torque Wrench Hoses

Use Enerpac THQ-700 Series hoses with W-Series torque wrenches to ensure the integrity of your hydraulic system.

19.5 feet long, 2 hoses	THQ-706T
39 feet long, 2 hoses	THQ-712T

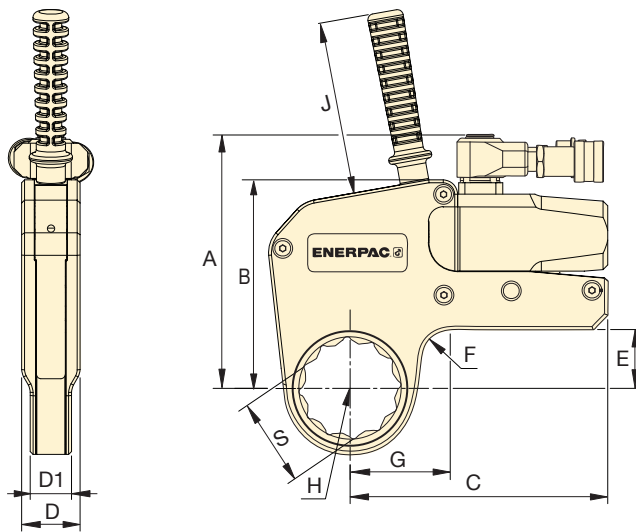

▼ SELECTION CHART

Hexagon Size	Nominal Torque @ 10,000 psi	Cassette Model Number	Minimum Torque @ 1000 psi	Nose Radius	Dimensions (in)									Weight (lbs)	Drive Unit Model* (sold separately)	
					G	A	B	C	D	D1	E	F (radius)	J			
S (in)	(Ft.lbs)		(Ft.lbs)	H (in)												
1 ¹³ / ₁₆	1980	W2113SL	200	1.44	2.35										4.87	W2000X
2 ⁹ / ₁₆	1980	W2203SL	200	1.63	2.49	5.54	4.30	5.81	1.28	1.00	0.94	0.79	4.72	4.87		
2 ³ / ₈	1980	W2206SL	200	1.75	2.56									4.88		
2 ⁹ / ₁₆	4360	W4203SL	430	1.73	2.70									10.15	W4000X	
2 ³ / ₈	4360	W4206SL	430	1.89	2.82									10.36		
2 ⁹ / ₁₆	4360	W4209SL	430	1.99	2.92	6.91	5.69	7.03	1.59	1.13	1.61	0.79	4.72	10.37		
2 ³ / ₄	4360	W4212SL	430	2.11	2.98									10.42		
2 ¹⁵ / ₁₆	4360	W4215SL	430	2.20	2.99									10.37		

* May also be used with **W2000PX** and **W4000PX** drive units, featuring double-swivel manifolds.

▼ WCR4000 Roller Cassette with Spanner and W4000 Drive Unit



WCR Series

Bi-Hexagonal Spanner Size:

1⁷/₁₆-3¹/₈ inch

Spanner Nose Radius:

1.22-2.18 inch

Nominal Torque:

4250 Ft-lbs

Maximum Operating Pressure:

10,000 psi



WCR4000 Torque Wrench

The **WCR4000** combines power and durability with a slim spanner design to provide bolting professionals with one of the most versatile and high performing limited access tools on the market today.

The tool was designed for use in narrow access applications, particularly in the height above the nut, and between the bolt center, and the inside of the joint.

Ideal for bolting API flanges, the **WCR4000** is available with a wide range of ring type spanners, and is powered by the standard W4000X drive unit.

- **Spanners available to fit most commonly used API flanges**
- **Small nose radius – resolves bolt to pipe restrictions**
- **Slim spanner design – reduces bolt height restrictions**
- **Wide range of spanners ranging from 1⁷/₁₆ - 3¹/₈ inches (36 - 80 mm)**
- **Includes handle to improve tool handling and safety**
- **Rigid solid steel body for maximum endurance and minimum downtime**

Closed Spanner Hexagon Size		Closed Spanner Model Number	Spanner Radius R (in)	Weight * (lb)	Roller Cassette Assy Model No.**	Drive Unit Model No.
S (in)	S (mm)					
1 ⁷ / ₁₆	36	W4107CS	1.22	4.2	WCR4000	W4000X
1 ¹ / ₂	38	W4108CS	1.29	4.4		
1 ⁵ / ₈	41	W4110CS	1.29	4.2		
1 ¹³ / ₁₆	46	W4113CS	1.40	4.3		
1 ⁷ / ₈	48	W4114CS	1.51	4.7		
2	50	W4200CS	1.51	4.2		
2 ⁹ / ₁₆	55	W4203CS	1.62	4.3		
2 ³ / ₈	60	W4206CS	1.77	4.6		
2 ⁹ / ₁₆	65	W4209CS	1.84	4.6		
2 ³ / ₄	70	W4212CS	1.95	4.7		
2 ¹⁵ / ₁₆	75	W4215CS	2.05	4.6		
3 ¹ / ₈	80	W4302CS	2.18	4.9		

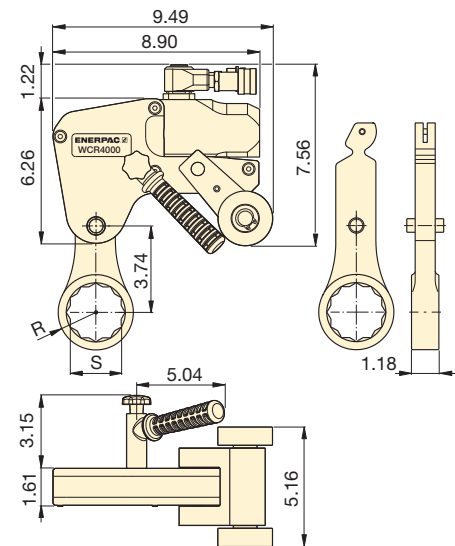

*For total weight add 13.89 lbs for WCR4000, 4.40 lbs. for W4000X and weight of the spanner.

** The WCR4000 cassettes, spanners and drive units are all sold separately.

Accessories for W-Series, X-Edition Torque Wrenches

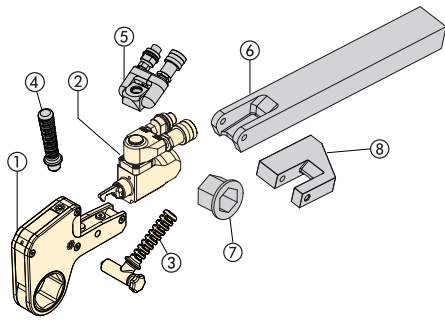

- ① Hexagon Cassette
- ② Drive Unit
- ③ Angled Positioning Handle
- ④ Straight Positioning Handle (optional)
- ⑤ Pro Series Swivel (optional)
- ⑥ Extended Reaction Arm (optional)
- ⑦ Reducer Insert (optional)
- ⑧ Reaction Paddle (optional)

**TSP
WTE
WRP
Series**



TSP-Series, Pro Series Swivels

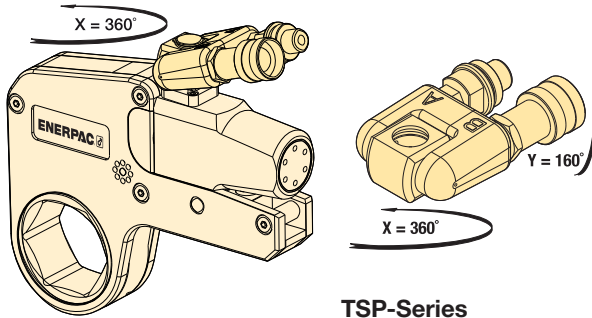

- Robust interlocking design
- 360° X-axis and 160° Y-axis rotation
- Increases tool fit in restricted access areas
- Simplifies hose placement
- Includes male and female couplers

Torque Wrench Model Number	Model Number	Maximum Pressure (psi)	Wt. (lbs)
W2000X, W4000X, W8000X, W15000X, W22000X, W35000X	TSP300*	10,000	.44

Note: To order a W-series (X-Edition) wrench fitted with the TSP swivel, insert a "P" prior to the "X" in the tool designation, e.g., W2000PX.

* TSP300 is designed for X-Edition tools only, and is not compatible with standard edition tools. For replacement components for existing tools, refer to repair sheet on www.enerpac.com

WTE-Series, Extended Reaction Arm

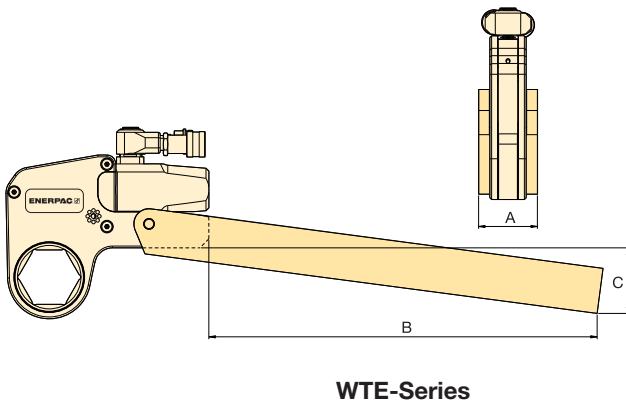

- Full torque rated
- Increases tool fit in restricted access areas

Torque Wrench Model Number	Model Number	Dimensions (in)			Wt.* (lbs)
		A	B	C	
W2000X	WTE20	2.20	15.67	2.66	5.73
W4000X	WTE40	2.60	17.17	2.91	10.14
W8000X	WTE80	3.35	17.68	2.15	16.76
W15000X	WTE150	4.02	19.61	2.83	26.46
W22000X	WTE220	4.49	20.51	3.03	38.14
W35000X	WTE350	5.00	16.48	5.23	39.24

* Weights indicated are for the accessories only and do not include the wrench.

WRP-Series Reaction Paddles

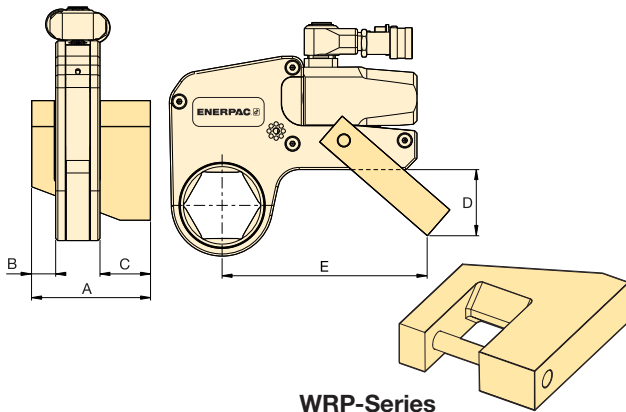

- Lightweight interchangeable design
- Allows for offset reaction when in-line reaction is not available

Torque Wrench Model Number	Model Number	Dimensions (in)					Wt.* (lbs)
		A	B	C	D	E	
W2000X	WRP20	3.31	0.63	1.40	1.77	5.83	.88
W4000X	WRP40	4.29	0.83	1.87	2.32	7.48	1.76
W8000X	WRP80	5.37	1.02	2.25	2.72	8.78	4.41
W15000X	WRP150	6.50	1.26	2.74	3.43	10.12	8.60
W22000X	WRP220	8.15	1.52	3.58	5.28	12.48	15.87
W35000X	WRP350	9.22	1.79	3.58	7.17	13.98	23.37

* Weights indicated are for the accessories only and do not include the wrench.

▼ Shown: PTW1000



Continuous Rotation Controlled Torque



Typical Pneumatic Torque Wrench Applications

Mining

- Track maintenance
- Undercarriage maintenance
- Wheel maintenance
- Shovel maintenance

Power Generation

- Turbine bolts
- Tower segments
- Turbine casings

Oil and Gas

- Pipe flanges
- Valves
- Manway covers
- Pressure vessels

Productivity

- High speed continuous rotation for constant torque output
- Low friction planetary gearbox design minimizes wear and extends uptime

Safety

- Ergonomic, low vibration design reduces fatigue and the risk of vibration related injuries for the operator
- Low noise air motor provides quiet, consistent performance for indoor and outdoor applications

Convenience

- Provided with standard reaction arm; wide assortment of custom arms and accessories are available
- Available with or without Filter-Regulator-Lubricator (FRL)
- Unique calibration certificate provided with each tool

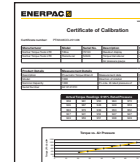

Calibration Certificate

All PTW tools are CE declared and are shipped complete with a calibration certificate.



▼ PTW-Series Pneumatic Torque Wrenches are ideal for applications where speed and precision are critical, such as track maintenance.



◀ The PTW1000 makes quick work of this flange maintenance job.



Pneumatic Torque Wrenches



PTW-Series Pneumatic Torque Wrenches

Enerpac PTW-Series Pneumatic Torque

Wrenches are designed for applications that require speed and control. The standard package includes a Torque Wrench with a calibration certificate, an FRL (Filter/Regulator/Lubricator), and a 10 ft. (3 m) long, 1/2" (13 mm) diameter air hose, which connects the FRL to the wrench.

Once the air hoses are connected, the operator simply adjusts the air pressure on the FRL to achieve the desired torque using the calibration certificate. After this, the tool is ready to go to work!*

The air source used with the PTW system must be regulated and/or limited to 120 psi (8.3 bar), and must be capable of providing a volume of at least 50 CFM (85 CMH) at 100 psi (6.9 bar). A separate 1/2" (13 mm) hose (not included) must be used to connect the FRL to the air supply.

*See instruction manual for comprehensive instructions

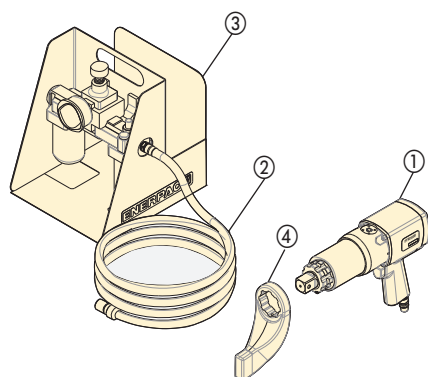

- ① PTW Torque Wrench
- ② Hose
- ③ Filter-Regulator-Lubricator
- ④ Reaction Arm

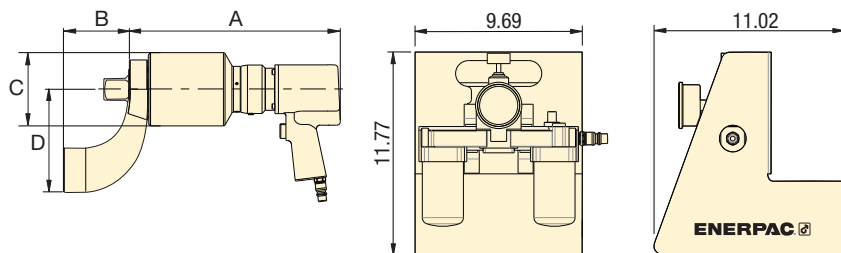

All tools are shipped complete with standard reaction arm and FRL*.

▼ SELECTION CHART

Minimum Torque		Nominal Torque		Square Drive (in)	Model Number*	RPM	Dimensions (in)				Weight** (lbs)
(Ft.lbs)	(Nm)	(Ft.lbs)	(Nm)				A	B	C	D	
300	407	1000	1356	1	PTW1000C	12.6	10.70	3.27	2.83	5.12	18
500	678	2000	2712	1	PTW2000C	8.0	11.26	3.27	3.11	5.24	19.5
900	1220	3000	4067	1	PTW3000C	3.1	13.50	3.27	3.74	5.24	23
1300	1763	6000	8135	1 1/2	PTW6000C	2.5	14.40	4.49	5.00	7.00	39

* To order without FRL and hose, remove "C" Suffix (e.g. PTW3000).

** Weight of wrench only without reaction arm. Reaction arm weight for PTW1000, PTW2000, PTW3000 is 2.9 lbs. and for the PTW6000 is 7.75 lbs.

PTW Series



Nominal Output Torque:

6000 Ft.lbs

Square Drive Range:

1 - 1 1/2 inch



Pneumatic Torque Wrench Accessories

Enerpac offers a full line of accessories including a range of reaction arms and drives.

Page: 230



Filter-Regulator-Lubricator

Recommended for use with all PTW pneumatic torque wrenches.

Provides clean, lubricated air and allows for air pressure adjustment.

Order model number*

FRL120C



BSH-Series Sockets

Heavy-Duty Impact Sockets for power driven torquing equipment.

Page: 210



Hydraulic Torque Wrenches

Enerpac offers a complete range of square drive and hexagon cassette torque wrenches. Details on www.enerpac.com.

Page: 203

▼ Shown: TW3000B (torque wrench shown without servo motor cord)*



Your Simple Solution for Smart Bolting



Touchscreen Control Box

ETW tools feature an easy to use, interactive touch-screen control box, which helps make even the most complex jobs simple to complete.

A single control box may be used to operate multiple wrench models.

Firmware upgrades may be uploaded online and easily transferred to the tool via a USB connection.



Easy Access to Controls

Controls on back of wrench with LED display allow user to directly input desired torque, change direction of rotation, and monitor the fastening process.

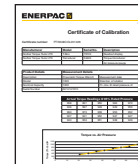

Certifications, Declarations

All ETW tools:

- Are shipped complete with a calibration certificate
- Are certified for North American Electrical Safety by CSA International
- Carry a CSA US and Canada mark
- Are CE declared



▼ ETW-Series Electric Torque Wrenches are ideal for high volume fastening applications that require precision and traceability, such as this wind tower job.



Versatility

- Patented firmware design provides accurate fastening on soft, hard, or pre-tightened joints
- Single control box may be used to operate multiple wrench models
- Wrenches and control boxes may be purchased separately or as a set

Performance

- High speed continuous rotation gets the job done faster
- Torque and angle functionality allows input of nominal torque value followed by a specific angle of rotation
- Pass/Fail LED indicator on back of tool verifies fastening has been completed according to specified input

Simplicity

- Control box with large 7-inch touchscreen simplifies tool operation
- Controls on back of wrench enable operator to monitor and manage the fastening process without returning to the control box
- Brightly lit three line LED display on wrench is easy to read in any environment

Traceability

- Fastening record can be viewed on-screen and transferred to a computer
- Each tool is performance tested and shipped complete with a factory calibration certificate

Safety

- Lift points on wrench enable use with positioning handle or lifting device for greater handling safety
- Ground fault detector protects operator in the event of insufficient grounding

* NOTE: Wrench cannot be used without control box.



ETW-Series Electric Torque Wrenches

Enerpac ETW-Series Electric Torque Wrenches are particularly well suited to complex jobs which demand precision and traceability. The tools feature an automatic mode, which helps simplify and automate complex jobs, including those with torque and angle specifications, through the creation of presets.

Using the touchscreen, simply input the number of fasteners and desired torque value for each fastening step, followed by the required angle of turn. This sequence may then be saved as an automatic preset for future use.

Once the input torque is achieved, the tool stalls, and a pass/fail indicator verifies that it is ready to move on to the next fastener.

When the job is completed, the fastening record can be viewed on the touch screen, or exported to a computer via a USB connection on the control box.

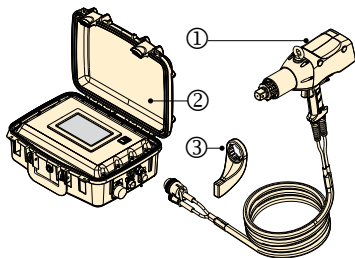

ETW Set

- ① ETW Torque Wrench (with 20 ft. servo cord)
- ② Control Box (with 6 ft. power cord)
- ③ Reaction Arm

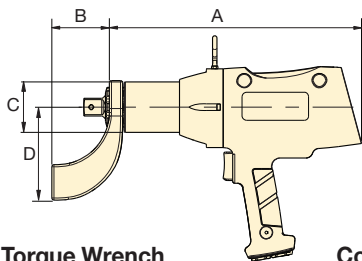

ETW Torque Wrench

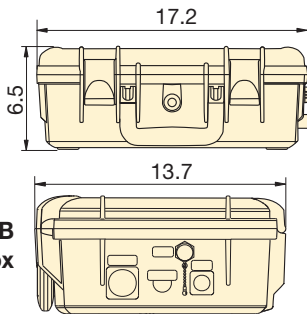

ETWCB Control Box

ETW Series



Nominal Output Torque:
6000 Ft.lbs

Square Drive Range:
1 - 1½ inch



Torque Wrench Accessories

Enerpac offers a full line of accessories including a wide range of reaction arms and drives.

Page: 230



BSH-Series Sockets

Heavy-Duty Impact Sockets for power driven torquing equipment. Details on www.enerpac.com.

Page: 210

Voltage: (Model No. ending with suffix)

- B = 115V, 60 Hz
- I = 230V, 60 Hz (with NEMA 6-15 plug)
- E = 230V, 50 Hz (with commonly used European (SCHUKO) plug)

Minimum Torque		Nominal Torque		Square Drive (in)	ETW Set Model Number	ETW Set Includes		Voltage	Nominal Speed RPMs	Dimensions (in)				Wrench Weight ¹⁾ (lbs)
(Ft.lbs)	(Nm)	(Ft.lbs)	(Nm)			Wrench Model No. ²⁾	Control Box Model No. ²⁾			A	B	C	D	
200	270	1000	1355	1.0	ETW1000B	TW1000B	ETWCB-B	115V 60 Hz	9.8	14.4	3.3	2.8	5.2	18.1
200	270	1000	1355	1.0	ETW1000I	TW1000EI	ETWCB-I	230V 60 Hz	15.2	14.4	3.3	2.8	5.2	18.1
200	270	1000	1355	1.0	ETW1000E	TW1000EI	ETWCB-E	230V 50 Hz	15.2	14.4	3.3	2.8	5.2	18.1
400	540	2000	2710	1.0	ETW2000B	TW2000B	ETWCB-B	115V 60 Hz	5.8	15.0	3.3	3.1	5.2	19.7
400	540	2000	2710	1.0	ETW2000I	TW2000EI	ETWCB-I	230V 60 Hz	9.0	15.0	3.3	3.1	5.2	19.7
400	540	2000	2710	1.0	ETW2000E	TW2000EI	ETWCB-E	230V 50 Hz	9.0	15.0	3.3	3.1	5.2	19.7
600	810	3000	4065	1.0	ETW3000B	TW3000B	ETWCB-B	115V 60 Hz	2.8	17.1	3.3	3.7	5.2	26.3
600	810	3000	4065	1.0	ETW3000I	TW3000EI	ETWCB-I	230V 60 Hz	4.3	17.1	3.3	3.7	5.2	26.3
600	810	3000	4065	1.0	ETW3000E	TW3000EI	ETWCB-E	230V 50 Hz	4.3	17.1	3.3	3.7	5.2	26.3
1200	1625	6000	8135	1.5	ETW6000B	TW6000B	ETWCB-B	115V 60 Hz	1.9	17.8	4.5	5.0	7.0	42.1
1200	1625	6000	8135	1.5	ETW6000I	TW6000EI	ETWCB-I	230V 60 Hz	2.9	17.8	4.5	5.0	7.0	42.1
1200	1625	6000	8135	1.5	ETW6000E	TW6000EI	ETWCB-E	230V 50 Hz	2.9	17.8	4.5	5.0	7.0	42.1

¹⁾ Weight of wrench only without reaction arm. Reaction arm weight for ETW1000, ETW2000, ETW3000 is 2.9 lbs. and for the ETW6000 is 7.75 lbs. Standard reaction arm included with TW-models. Weight of control box is 20 lbs.

²⁾ Use of ETW requires both wrench and control box. These may be purchased separately, or as a calibrated set.



PTW and ETW-Series Torque Wrenches

Enerpac offers the following accessories to support a wide variety of applications in industries such as mining, power generation and oil and gas. For additional custom accessories not pictured here, please contact Enerpac.

PTW ETW Series



Nominal Output Torque:

6000 Ft.lbs

Square Drive Range:

1 - 1½ inch

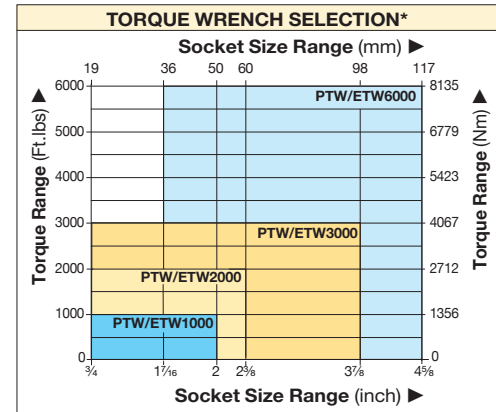
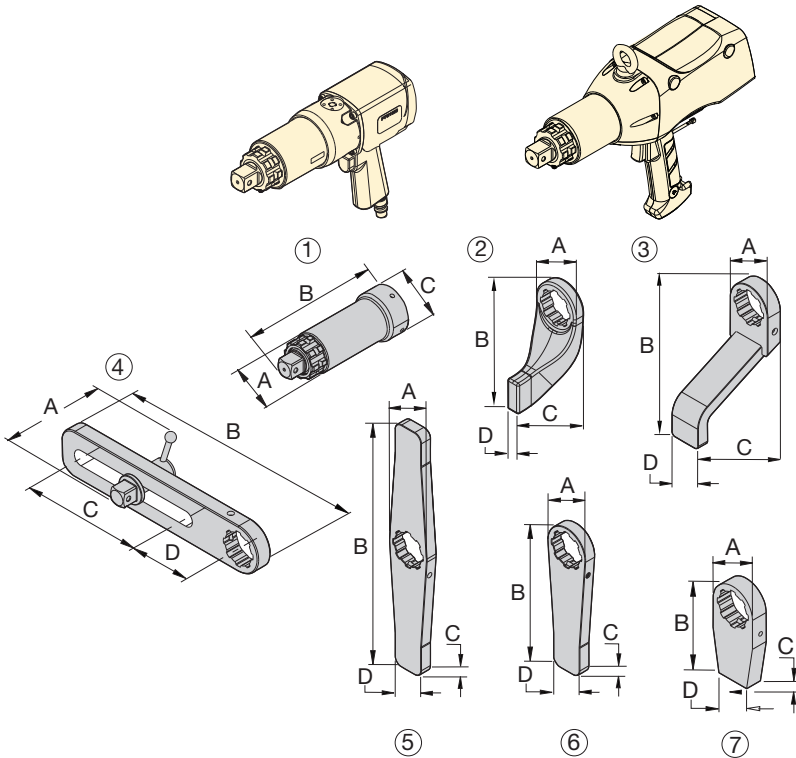

BSH-Series Sockets

Heavy-Duty Impact Sockets for power driven torquing equipment. Details on www.enerpac.com.

210

▼ Optional accessories for use with PTW1000, ETW1000, PTW2000, ETW2000, PTW3000, ETW3000 models

No.	Description	Model No.	Application	Dimensions in inches			
				A	B	C	D
1	Extended Drive, 6 inch (152 mm)	ED6TWS	Nose extension, primarily for truck wheel bolts	2.44	8.11	2.87	—
1	Extended Drive, 12 inch (305 mm)	ED12TWS		2.44	15.12	2.87	—
1	Extended Drive, 18 inch (457 mm)	ED18TWS		2.44	20.12	2.87	—
2	Standard Reaction Arm	RATWS	Standard arm included with PTW/ETW model	2.99	6.77	4.02	0.83
3	Extended Reaction Arm	ERATWS	Long plate for use with deep well sockets	2.87	5.91	7.95	2.01
4	Sliding Reaction Arm	SLRATWS	For widely spaced and uneven bolt centers	4.41	15.00	7.99	4.02
5	Double Straight Reaction Arm	DSATWS	Reduces time to reposition arm *	2.87	15.98	0.75	4.02
6	Straight Reaction Arm	SRATWS	Long plate for wide spaced reaction points	2.87	9.45	0.75	2.01
7	Blank Reaction Arm **	BLTWS	Weldable blank for custom applications **	2.83	5.94	0.98	2.01

▼ For use with PTW6000, ETW6000 models

1	Extended Drive 6 inch (152 mm)	ED6TWL	Nose extension, primarily for truck wheel bolts	3.31	9.13	4.02	—
1	Extended Drive 12 inch (305 mm)	ED12TWL		3.31	15.12	4.02	—
2	Standard Reaction Arm	RATWL	Standard arm included with PTW/ETW model	4.02	9.02	5.75	1.26
3	Extended Reaction Arm	ERATWL	Long plate for use with deep well sockets	4.02	10.00	7.24	2.52
4	Sliding Reaction Arm	SLRATWL	For widely spaced and uneven bolt centers	5.98	16.50	7.48	4.49
5	Double Straight Arm	DSATWL	Reduces time to reposition arm *	4.02	20.00	1.26	2.24
6	Straight Reaction Arm	SRATWL	Long plate for wide spaced reaction points	4.02	12.01	1.26	2.24
7	Blank Reaction Arm **	BLTWL	Weldable blank for custom applications **	4.02	5.98	1.26	2.24

* Time to reposition arm when repeatedly moving from tightening to loosening.

** ⚠ WARNING: Blank reaction arms must be heat treated to HRc 38-42 prior to use.

Custom Hydraulic Torque Wrenches

Looking for customized components to help solve your torquing problems? Enerpac has the experience and capabilities to help find solutions to your problems.

Enerpac hydraulic torque wrenches are designed to accommodate most bolting applications. However, due to space constraints, location of reaction points

or need for special sockets and adapters, there is often a need for customized components.



◀ *Custom hydraulic torque wrench for a fracking pump.*



◀ *Custom S6000X hydraulic torque wrench fitted with a custom reaction arm/socket.*



◀ *Custom hydraulic torque wrenches with reaction paddles for use with a flexible flowline.*

OVERVIEW





















▲ *Custom S11000X torque wrench with a custom torque link and reaction roller*

CUSTOMIZABLE FEATURES:

- Reaction Arms
- Torque Links (split or layered for extremely space restricted applications)
- Reaction Roller Assemblies
- Sockets (direct drive, castellated, peg drive, stacked)
- Drives (direct Allen, spline, square drive size)
- Hex Reducing and Square Drive Inserts

Optimum Torque Wrench and Pump Combinations

For optimum speed and performance Enerpac recommends the following system set-up with wrench-pump-hose combinations.

		ELECTRIC PUMPS				AIR DRIVEN PUMP
		PMU-Series	ZU4-Series	TQ-700-Series	ZE4/5-Series	ZA4-Series
						
		Page: 233	Page: 236	Page: 234	Page: 240	Page: 242
Speed:						
Oil Capacity:	.5 - 1 Gal.	1 - 1.75 Gal.	1 Gal.	1-10 Gal.	1 - 1.75 Gal.	
Duty Cycle:	Standard duty	Standard duty	Medium duty	Heavy duty	Heavy duty	
Weight:						
Field/Factory Work:	Field	Field	Field/Factory	Factory	Field	
S-Series  206	S1500X	Optimal	Optimal	Optimal	Optimal	Optimal
	S3000X			Optimal		
	S6000X			-		
	S11000X			-		
	S25000X			-		
W-Series  212	W2000X	Optimal	Optimal	Optimal	Optimal	Optimal
	W4000X	Optimal	Optimal	Optimal	Optimal	Optimal
	W8000X	-	Optimal	Optimal	Optimal	Optimal
	W15000X	-	Optimal	Optimal	Optimal	Optimal
	W22000X	-	Optimal	Optimal	Optimal	Optimal
W35000X	-	Optimal	Optimal	Optimal	Optimal	



ZU4 Electric Torque Wrench Pump

Utilizing a universal motor, the ZU4-Series has excellent low voltage characteristics. It works well with long extension cords or generator driven electrical power supplies. A field proven, efficient design ensures this pump is dependable and will draw less current—lowering your operating cost. The pumps are available in Pro and Classic formats.

ZU4 Pro pumps have an LCD feature to display torque or pressure, selectable torque wrench, and self-diagnostics – premium features not available on any other pump.

ZU4 Classic pumps feature an analogue gauge and a basic electrical package to deliver durable, safe and efficient hydraulic power.

ZE-Series Electric Torque Wrench Pump

The ZE-Series features premium options, such as the LCD to display torque or pressure values, and self-diagnostics. These pumps utilize an induction motor, making the ZE-Series the coolest and quietest pumps in their class.

ZA-Series Air Driven Torque Wrench Pump

Utilizing the highly efficient design of the Z-Class pumping element, this air driven pump is best suited to power medium to large size torque wrenches

TQ-700 Series Electric Torque Wrench Pump

Designed for both portability and production, the TQ-700 features optimized flow technology to deliver superior bolting speed.



Twin Torque Wrench Hoses

Use Enerpac THQ-700 series twin hoses with 10,000 psi pumps, or use THC-700 series twin hoses with 11,600 psi pumps.

For S & W (10,000 psi)	
19.5' long, 2 hoses	THQ-706T
39' long, 2 hoses	THQ-712T
For SQD & HXD (11,600 psi)	
19.5' long, 2 hoses	THC-7062
39' long, 2 hoses	THC-7122

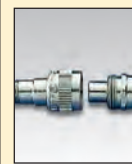

Torque Wrench Couplers

For torque wrench couplers see our "System Components" section in this catalog.

Portable Electric Torque Wrench Pumps

▼ Shown: PMU-10427



- Powerful two-speed pump is lightweight and easy to carry
- Standard heat exchanger package keeps pump cool under extreme use
- Glycerin filled gauge with scales reading in psi and bar
- Transparent overlays in Ft.lbs and Nm for all Enerpac torque wrenches provide a quick torque reference
- Universal motor for a high power-to-weight ratio; generates full pressure on as little as 50% of the rated line voltage
- Adjustable pressure relief valve for accurate torque adjustments and precise repeatability

PMU/PME Series

Reservoir Capacity:

0.5-1 gal.

Flow at 10,000 psi:

20 in³/min.

Motor Size:

0.5 hp

Maximum Operating Pressure:

10,000 and 11,600 psi



Pump Ratings

-Q suffix pumps are for 10,000 psi torque wrenches, and include spin-on couplers.

-E suffix pumps are for use with 11,600 psi rated torque wrenches, and include polarized lock-ring safety couplers.



Twin Torque Wrench Hoses

Use Enerpac THQ-700 series twin hoses with 10,000 psi pumps, or use THC-700 series twin hoses with 11,600 psi pumps.

with 11,600 psi pumps.

10,000 psi	
19.5 feet long, 2 hoses	THQ-706T
39 feet long, 2 hoses	THQ-712T
11,600 psi	
19.5 feet long, 2 hoses	THC-7062
39 feet long, 2 hoses	THC-7122

▼ SELECTION CHART

For Use With Torque Wrenches		Maximum Pressure Rating (psi)		Oil Flow Rate (in ³ /min)		Model Number	Useable Oil Capacity (gal)	Electric Motor	Dimensions L x W x H (in)	Weight (lbs)
		1 st stage	2 nd stage	1 st stage	2 nd stage					
S1500X S3000X	W2000X W4000X	700	10,000	200	20	PMU-10427-Q	.50	115V- 1 ph -50/60Hz	17 x 11 x 15	46
		700	10,000	200	20	PMU-10447-Q	1.0	115V- 1 ph -50/60Hz	17 x 13 x 15	53
		700	10,000	200	20	PMU-10422-Q	.50	230V- 1 ph -50/60Hz	17 x 11 x 15	46
		700	10,000	200	20	PMU-10442-Q	1.0	230V- 1 ph -50/60Hz	17 x 13 x 15	53
SQD-25-I SQD-50-I	HXD-30 HXD-60	700	11,600	200	20	PMU-10427	.50	115V- 1 ph -50/60Hz	17 x 11 x 15	46
		700	11,600	200	20	PMU-10447	1.0	115V- 1 ph -50/60Hz	17 x 13 x 15	53
		700	11,600	200	20	PMU-10422	.50	230V- 1 ph -50/60Hz	17 x 11 x 15	46
		700	11,600	200	20	PMU-10442	1.0	230V- 1 ph -50/60Hz	17 x 13 x 15	53

* For pump without heat exchanger change PMU into PME. Example: PME-10442-Q.
PME-Series pump size 10 x 10 x 14 inches. Weight 37.5 lbs. (.50 gallon) and 44 lbs (1 gallon).

▼ Shown: TQ-700E



- Three stage pump design delivers optimized flow rates and enables up to 50% faster bolting than competing pumps
- Compact and lightweight design fits through tight openings and provides easy handling
- Built-in protection for controls, gauge, and pendant for job-site durability
- IP55 rating for superior dust and water protection
- Advanced brushless motor provides for quiet, continuous operation, high voltage tolerance, and low maintenance
- Heat exchanger prevents breakdown of oil during heavy usage in hot environments
- Simple pressure setting and convenient pendant control for hassle-free operation

▼ The TQ-700E and the W-Series wrenches are a productive combination in wind applications.



Lightweight Electric Torque Wrench Pump



Optimized for S- and W-series Hydraulic Torque Wrenches

Enerpac offers a complete range of square drive and hexagon cassette torque wrenches.

Page: 203



Pendant Control

The TQ-700 comes equipped with a 20-foot pendant cord which allows the user to pressurize the pump from a distance increasing productivity and speed of setup.



Four Port Manifold

The TQ-700 Classic offers an optional four wrench manifold as an accessory (TQM) factory installed. (Add suffix "M" at the end of the model number. For example: TQ700EM)



Twin Torque Wrench Hoses

Use Enerpac THQ-700 series twin hoses with 10,000 psi pumps.

10,000 psi

19.5 feet long, 2 hoses	THQ-706T
39 feet long, 2 hoses	THQ-712T



Gauge Overlay Kit

Gauge overlay kits are also available separately.

GT-4015-Q includes overlays for all S- and W-Series

Torque Wrenches.

GT-4015 includes overlays for all SQD and HXD torque wrenches.

Electric Torque Wrench Pump



TQ-700 Series Pump Applications

The TQ-700 Series pump is ideal for powering hydraulic wrenches for the Power Generation and Wind Markets.

The TQ-700 has been engineered with **Optimized Flow Technology** to deliver up to 50% faster bolt tightening than competing pumps.

Bolting speed is more complex than how much flow per minute the pump produces. The key is optimizing the flow rate across the entire bolting cycle. With more oil flowing at the right time and at the right volume, you achieve the optimized flow for a hydraulic bolting system.

The result of this optimized flow is more bolts tightened faster and a more productive work team.

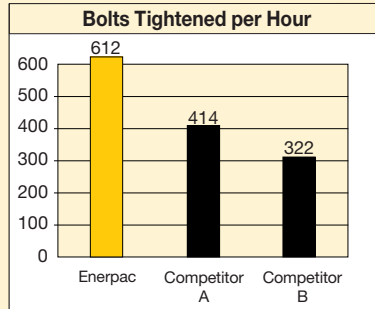

Internal laboratory testing based on standard torquing procedure on a pipe flange with 14, 1 1/8" bolts.

TQ Series



Reservoir Capacity:
1 gallon

Motor Size:
1.0 hp

Maximum Operating Pressure:
10,000 psi



IP55 Rating for Superior Dust and Water Protection

The IP Code (or Ingress Protection Rating) classifies and rates the degrees of protection provided against the intrusion of solid objects and water in mechanical casings and electrical enclosures.

An IP55 rating means the TQ-700 offers complete protection against contact with mechanical and electrical components, and that dust will not enter in a sufficient quantity to interfere with the operation of the equipment.

The IP55 rating also means water jets sprayed against the TQ-700 from any direction will not have any harmful effects.

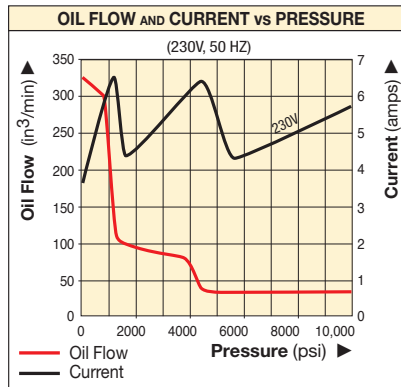
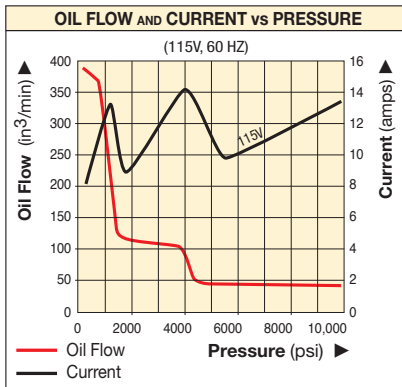

Dimensions shown in inches.

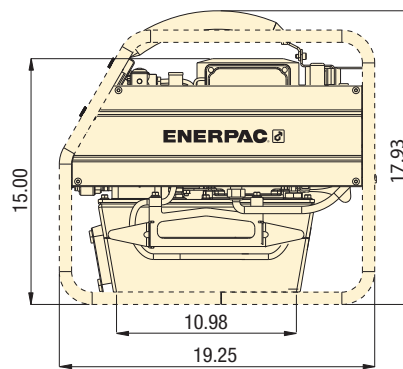
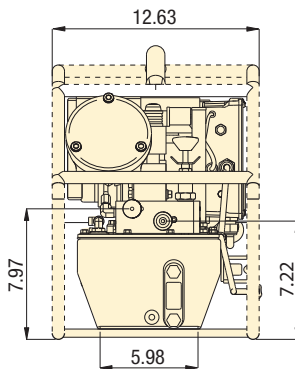

Performance	For Use with Torque Wrenches		Pressure Rating (psi)	Model Number ¹⁾	Usable Oil Capacity (gal)	Motor Electrical Specification	Sound Level (dBA)	Weight (no oil) (lbs)	
	S	W							
Optimal	S1500X	W2000X	10,000	TQ-700B	1	115V-1 ph, 50 / 60 Hz	82-85	68	
	S3000X	W4000X							
Acceptable	S6000X	W8000X		TQ-700E ²⁾		1	230V-1 ph, 50 Hz	82-85	66
	S11000X	W15000X		TQ-700I ³⁾					
	S25000X	W22000X							
		W35000X							

1) All models meet CE safety requirements and all TÜV requirements
 2) European plug and CE EMC directive compliant
 3) With NEMA 6-15 plug

▼ The TQ-700E and the W-Series wrenches are a productive combination.



▼ Shown: ZU4204TB-Q and ZU4204BB-Q



Z Tough.
Dependable.
Innovative.
CLASSIC



Classic Electrical

Basic electrical package includes mechanical contactor, ON/OFF toggle switch, pendant with electro-mechanical pushbuttons, 24V transformer timer and operator accessible circuit breaker.

- Features **Z-Class** high-efficiency pump design; higher oil flow and bypass pressure, cooler running and requires 18% less current draw than comparable pumps
- Powerful 1.7 hp universal electric motor provides high power-to-weight ratio and excellent low-voltage operating characteristics
- High-strength, molded composite shroud protects motor and electrical components, while providing an ergonomic, non-conductive handle for easy transport
- Low-voltage pendant provides additional safety for the operator

Pro-Series

- LCD readout provides pressure and torque display and a number of diagnostic and readout capabilities never before offered on a portable electric pump
- Auto cycle feature provides continuous cycle operation of the torque wrench as long as the advance button is pressed. (Pump can be used with or without auto cycle feature)



FIRMWARE for Pro-Series

- Display torque in Ft.lbs. or Nm
- Display pressure in bar, MPa or psi
- Torque wrench model is selectable
- "Auto cycle" setting easily programmable

www.enerpac.com



Back-lit LCD Display for Pro Series

- Digital pressure or torque read-out
- Programmable "Auto-Cycle" setting
- "Auto-Cycle" setting easily programmable
- Torque wrench model is selectable
- Display torque in Nm or Ft.lbs
- Pump usage information, hour and cycle counts
- Low-voltage warning and recording
- Self-test and diagnostic capabilities
- Information can be displayed in English, French, German, Italian, Spanish and Portuguese
- Pressure transducer is more accurate and durable than analog gauges



◀ Any brand of hydraulic torque wrench can be powered by the portable ZU4-Series torque wrench pump.



Z-Class – A Pump For Every Application

Patented Z-Class pump technology provides

high by-pass pressures for increased productivity—important in applications using long hose runs and high pressure-drop circuits, like heavy lifting or certain double-acting tools.

Enerpac ZU4 Hydraulic Pumps are built to power small to large torque wrenches. Choosing the right ZU4 torque wrench pump for your application is easy.

Classic Electric Torque Wrench Pump

- The Classic has an analog gauge and traditional electro-mechanical components (transformers, relays and switches) in place of solid-state electronics. The Classic

delivers durable, safe and efficient hydraulic power.

Pro Series Electric Torque Wrench Pump

- Digital (LCD) display features a built-in hour meter, pressure and torque display, and shows self-diagnostic, cycle-count and low voltage warning information. These premium features are not available on any other pump—anywhere!
- AutoCycle feature provides continuous cycle operation of the torque wrench as long as the advance button is pressed. (Pump can be used with or without AutoCycle feature).

ZU4T Series



Reservoir Capacity:

1 and 1.75 gal.

Flow at 10,000 psi:

60 in³/min.

Motor Size:

1.7 hp

Maximum Operating Pressure:

10,000 psi

OIL FLOW AND CURRENT vs PRESSURE

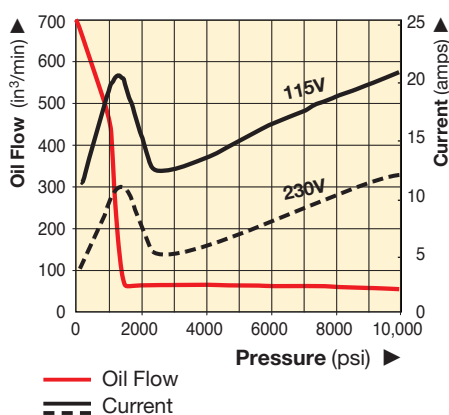

COMMON PUMP MODELS

	For Use With Torque Wrenches	Model Number ^{1) 4)}	Motor Electrical Specification	Usable Oil Capacity (gal)	Weight with Oil (lbs)
Pro Series	All wrenches	ZU4204TB-Q	115 V-1 ph	1.0	70
		ZU4208TB-Q	115 V-1 ph	1.75	76
		ZU4204TE-Q ²⁾	208-240 V-1 ph	1.0	70
		ZU4208TE-Q ²⁾	208-240 V-1 ph	1.75	76
		ZU4204TI-Q ³⁾	208-240 V-1 ph	1.0	70
		ZU4208TI-Q ³⁾	208-240 V-1 ph	1.75	76
Classic	All wrenches	ZU4204BB-QH	115 V-1 ph	1.0	82
		ZU4204BB-Q	115 V-1 ph	1.0	73
		ZU4208BE-QH ²⁾	208-240 V-1 ph	1.75	83
		ZU4204BE-Q ²⁾	208-240 V-1 ph	1.0	74
		ZU4208BI-QH ³⁾	208-240 V-1 ph	1.75	88
		ZU4208BI-Q ³⁾	208-240 V-1 ph	1.75	79

1) All models meet CE safety requirements and all TÜV requirements
 2) European plug and CE EMC directive compliant
 3) With NEMA 6-15 plug
 4) Replace the Q- suffix with an -E suffix for Enerpac SQD and HXD 11,600 psi torque wrench pumps

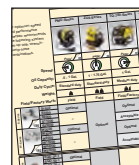

Torque Wrench Pump Selection Matrix

For optimum speed and performance see the torque wrench pump and hose selection matrix.

Page: 232



Pump Ratings

-Q suffix pumps are for 10,000 psi torque wrenches, and include spin-on couplers.

-E suffix pumps are for use with Enerpac SQD and HXD 11,600 psi torque wrenches, and include polarized lock-ring safety couplers.

Page: 238



Gauge Overlay Kit

Gauge overlay kits are also available separately.

GT-4015-Q includes overlays for all S- and W-Series torque wrenches.

GT-4015 includes overlays for all SQD and HXD torque wrenches.

www.enerpac.com

ZU4T Ordering Matrix and Specifications

▼ This is how a ZU4 Series pump model number is built up:



1	2	3	4	5	6	7	8	8	8
Product Type	Motor Type	Flow Group	Valve Type	Reservoir Size	Valve Operation	Voltage	Must be E or Q	Options	Options

1 Product Type

Z = Pump series

2 Motor Type

U = Universal electric motor

3 Flow Group

4 = 60 in³/min @ 10,000 psi

4 Valve Type

2 = Torque wrench valve

5 Reservoir Size (useable capacity)

04 = 1.0 gallon
08 = 1.75 gallons

6 Valve Operation

T = Solenoid valve with pendant, LCD Electric and pressure transducer
B = Solenoid valve with pendant, classic electrical

7 Voltage

B = 115V, 1 ph, 50/60 Hz
E = 208-240V, 1 ph, 50/60 Hz (with European plug CE RF compliant)
I = 208-240V, 1 ph, 50/60 Hz (with NEMA 6-15 plug)

8 Factory installed features and options

E = 11,600 coupler for use with HXD-, SQD-Series or other wrenches
Q = 10,000 coupler for use with S- and W-Series or other wrenches
H = Heat exchanger
K = Skidbar
M = 4-wrench manifold
R = Roll cage



How to order your ZU4T-Series torque wrench pump

Ordering Example 1

Model No. ZU4208TB-QMHK
10,000 psi pump for use with Enerpac S- and W-Series and other 10,000 psi torque wrenches, 115V motor, 1.75 gallon reservoir, 4-wrench manifold, heat exchanger and skidbar.

Refer to the torque wrench pump selection matrix for optimum wrench, pump and hose combinations.



Twin Torque Wrench Hoses

Use Enerpac **THQ-700** series twin hoses with 10,000 psi pumps, or use **THC-700** series twin hoses with 11,600 psi pumps.

10,000 psi	
19.5 feet long, 2 hoses	THQ-706T
39 feet long, 2 hoses	THQ-712T
11,600 psi	
19.5 feet long, 2 hoses	THC-7062
39 feet long, 2 hoses	THC-7122

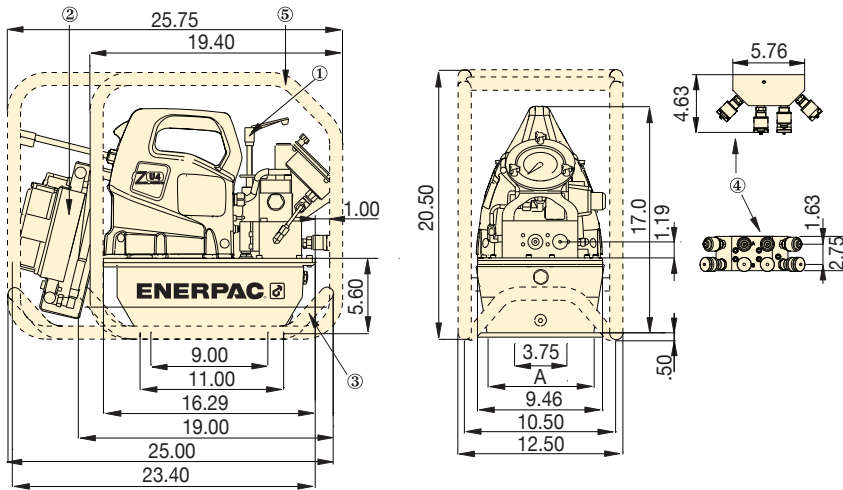

ZU4-Series Torque Wrench Pumps

Reservoir Size (useable gallons)	A (in)
1	6.0
1.75	8.1

Dimensions shown in inches

- ① User adjustable relief valve
- ② Heat exchanger (optional)
- ③ Skidbar (optional)
- ④ 4-wrench manifold (optional)
- ⑤ Roll cage (optional)

ZU4 Performance							
Motor Size (hp)	Output Flow Rate (in ³ /min)				*Motor Electrical Specification	Sound Level (dBA)	Relief Valve Adjustment Range (psi)
	100 psi	700 psi	5,000 psi	10,000 psi			
1.7	700	535	76	60	115 VAC, 1-ph 208-240 VAC, 1-ph	85-90	1,800-10,000**

* 50/60 HZ

** Pump type (-Q) shown, (-E) range is 1,800 - 11,600 psi.

▼ Most hydraulic torque wrenches can be powered by the Enerpac ZU4-Series torque wrench pump.



ZU4T Torque Wrench Pump Options



Heat Exchanger

- Removes heat from the bypass oil to provide cooler operation
- Stabilizes oil viscosity, increasing oil life and reduces wear of pump and other hydraulic components

Accessory Kit No. *	Can be used with:
ZHE-U115	115V pumps
ZHE-U230	230V pumps

* Add suffix **H** to pump model number for factory installation.
Heat Exchanger adds 9.1 lbs. to pump weight.

Ordering Example:
Model No. ZU4208TB-H



Skidbar

- Provides greater pump stability on soft or uneven surfaces
- Provides easy two-handed lift

Accessory Kit No. *	Can be used on ZU4-Series torque wrench pumps
SBZ-4	1 and 1.75 gallon ¹⁾
SBZ-4L	1 and 1.75 gallon ²⁾

* Add suffix **K** to pump model number for factory installation.

¹⁾ Without heat exchanger 4.9 lbs.

²⁾ With heat exchanger 7.0 lbs.

Ordering Example:
Model No. ZU4208TB-QK

ZU4T Series



Reservoir Capacity:
1 and 1.75 gal.

Flow at 10,000 psi:
60 in³/min.

Motor Size:
1.7 hp

Maximum Operating Pressure:
10,000 psi



Roll Cage

- Protects pump
- Provides greater pump stability

Accessory Kit No. *	Can be used on ZU4-Series torque wrench pumps
ZRC-04	1 and 1.75 gallon reservoir ¹⁾
ZRC-04H	1 and 1.75 gallon reservoir ²⁾

* Add suffix **R** for factory installation.

¹⁾ For use with pumps without a heat exchanger fitted

²⁾ For use with pumps with a heat exchanger fitted

Ordering Example:
Model No. ZU4208BB-QR



4-Wrench Manifold

- For simultaneous operation of multiple torque wrenches
- Can be factory installed or ordered separately

Accessory Kit No. *	Can be used on ZU4-Series torque wrench pumps
ZTM-E	for 11,600 psi torque wrenches
ZTM-Q	for 10,000 psi torque wrenches

* Add suffix **M** to pump model number for factory installation.

Ordering Example:
Model No. ZU4208TB-QM

▼ Shown: ZE4204TB-QHR



Z Tough.
Dependable.
Innovative.
CLASS



FIRMWARE for Pro-Series

- Display torque in Ft.lbs. or Nm
- Display pressure in bar, MPa or psi
- Torque wrench model is selectable
- "Auto cycle" setting easily programmable

www.enerpac.com

- Auto cycle feature provides continuous cycle operation of the torque wrench as long as the advance button is pressed (Pump can be used with or without auto cycle feature)
- LCD readout provides pressure and torque display and a number of diagnostic and readout capabilities never before offered on a portable electric pump
- Totally enclosed, fan-cooled industrial electric motors supply extended life and stand up to harsh industrial environments
- High-strength, molded electrical enclosure protects electronics, power supplies and LCD readout from harsh environments



Back-lit LCD Display

- Digital pressure or torque read-out
- Programmable "Auto-Cycle" setting
- "Auto-Cycle" setting easily programmable
- Torque wrench model is selectable
- Display torque in Nm or Ft.lbs
- Pump usage information, hour and cycle counts
- Low-voltage warning and recording
- Self-test and diagnostic capabilities
- Information can be displayed in English, French, German, Italian, Spanish and Portuguese
- Pressure transducer is more accurate and durable than analog gauges



◀ The ZE4 torque wrench pumps are perfectly matched for this W2000X wrench.

ZE Series Electric Torque Wrench Pumps

ZE4 and ZE5 Oil Flow and Current vs. Pressure

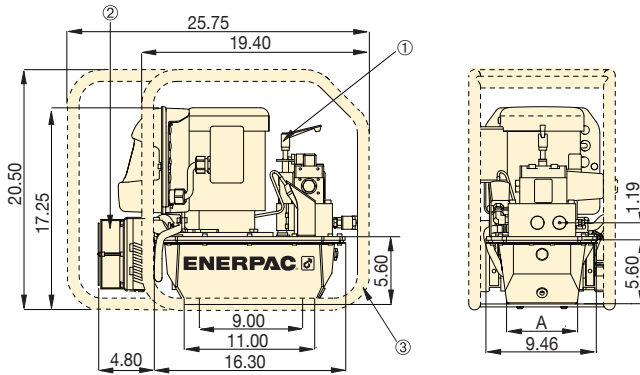
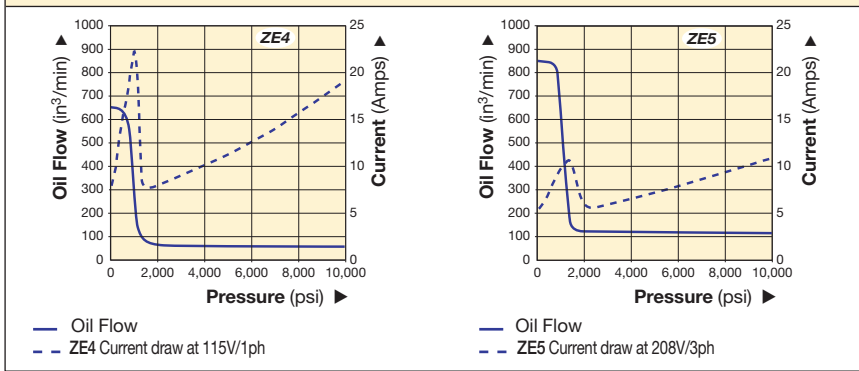

Reservoir Size (useable gallons)	A (in)
1	6.0
1.75	8.1

Dimensions shown in inches.
 ① User adjustable relief valve
 ② Heat Exchanger (optional)
 ③ Roll cage (optional)

▼ COMMON PUMP MODELS

For Use With Torque Wrenches	Max. Operating Pressure (psi)	Model Number with Heat Exchanger and Roll Cage	Motor Electrical Specification	Usable Oil Capacity ¹⁾ (gal)	Weight with Oil (lbs)
All S- and W-Series Wrenches	10,000	ZE4208TB-QHR	115 V-1 ph	2	129
	10,000	ZE4208TI-QHR	230 V-1 ph	2	129
	10,000	ZE4208TG-QHR	230 V-3 ph	2	131
	10,000	ZE5208TW-QHR	400 V-3 ph	2	131
All SQD and HXD-Series Wrenches	11,600	ZE4208TB-EHR	115 V-1 ph	2	138
	11,600	ZE4208TI-EHR	230 V-1 ph	2	129
	11,600	ZE4208TG-EHR	230 V-3 ph	2	141
	11,600	ZE5208TW-EHR	400 V-3 ph	2	132

¹⁾ Reservoir sizes available: 1, 2, 2.5, 5, 10 gallon. Contact Enerpac.

▼ PERFORMANCE CHART

Pump Series	Output Flow Rate (in ³ /min)				Motor Size		Relief Valve Adjustment Range (psi)	Sound Level (dBA)
	100 psi	700 psi	5,000 psi	10,000 psi	hp	RPM		
ZE4T	650	600	62	60	1.5	1750	1000 - 11,600	75
ZE5T	850	825	123	120	3.0	1750	1000 - 11,600	75

Flow rate will be approximately 5/6 of these values at 50 Hz.

ZE Series



Reservoir Capacity:

1.0 -10 gal.

Flow at 10,000 psi:

60-120 in³/min.

Motor Size:

1.5-3.0 hp

Maximum Operating Pressure:

10,000 and 11,600 psi



Accessory Options

A full list of optional accessories can be found in the ZU4 section.

Page: 239



Twin Torque Wrench Hoses

Use Enerpac THQ-700 series twin hoses with 10,000 psi pumps, or use THC-700 series twin hoses with 11,600 psi pumps.

10,000 psi	
19.5 feet long, 2 hoses	THQ-706T
39 feet long, 2 hoses	THQ-712T
11,600 psi	
19.5 feet long, 2 hoses	THC-7062
39 feet long, 2 hoses	THC-7122

▼ Shown: ZA4204TX-QR



Z Tough.
Dependable.
Innovative.
CLASS

- Two-speed operation and high by-pass pressure reduces cycle time for improved productivity
- Glycerin filled pressure gauge with transparent overlays in Ft.lbs and Nm for Enerpac torque wrenches provide a quick torque reference
- Regulator-Filter-Lubricator with removable bowls and auto drain is standard
- Ergonomic pendant allows remote operation up to 20 feet
- Valve technology reduces oil operating temperatures and withstands contaminants to increase pump reliability



Twin Torque Wrench Hoses

Use Enerpac **THQ-700** series twin hoses with 10,000 psi pumps, or use **THC-700** series twin hoses with 11,600 psi pumps.

10,000 psi	
19.5 feet long, 2 hoses	THQ-706T
39 feet long, 2 hoses	THQ-712T
11,600 psi	
19.5 feet long, 2 hoses	THC-7062
39 feet long, 2 hoses	THC-7122



Gauge Overlay Kit

Gauge overlay kits are also available separately.

GT-4015-Q includes overlays for all S- and W-Series torque wrenches.

GT-4015 includes overlays for all SQD and HXD torque wrenches.

GT-4015 includes overlays for all SQD and HXD torque wrenches.



◀ Most hydraulic torque wrenches can be powered by the Enerpac ZA4-Series torque wrench pump.

ZA4T Air Driven Torque Wrench Pumps



ZA4-Series Pump Applications

The ZA4-Series pump is best suited to power medium to large size torque wrenches.

Patent-pending *Z-Class* technology provides high by-pass pressures for increased productivity. Its high power-to-weight ratio and compact design make it ideal for applications which require easy transport of the pump.

For further application assistance contact your local Enerpac office.

ATEX Certified

The ZA-series pumps are tested and certified according to the **Equipment Directive 94 / 9 / EC "ATEX Directive"**.

The explosion protection is for equipment group II, equipment category 2 (hazardous area zone 1), in gas and/or dust atmospheres. The ZA-series pumps are marked with: Ex II 2 GD ck T4.



ZA4T Series



Reservoir Capacity:
1 and 1.75 gal.

Flow at 10,000 psi:
60 in³/min.

Air Consumption:
20-100 scfm

Maximum Operating Pressure:
10,000 and 11,600 psi



Torque Wrench Pump Selection Matrix

For optimum speed and performance see the torque wrench, pump and hose selection matrix.

Page: 232

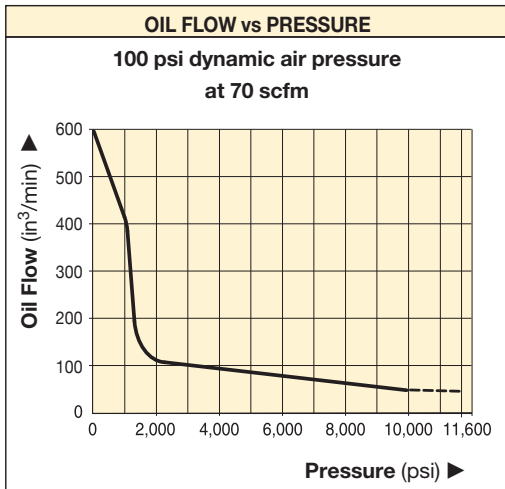

COMMON PUMP MODELS

For Use With Torque Wrenches	Maximum Operating Pressure (psi)	Model Number ¹⁾	Usable Oil Capacity (gal)	Weight with Oil (lbs)
For all S- and W- Series (X-Edition)	10,000	ZA4204TX-Q	1.0	94
	10,000	ZA4208TX-Q	1.75	100
	10,000	ZA4204TX-QR	1.0	101
	10,000	ZA4208TX-QR	1.75	112
For all SQD- and HXD-Series	11,600	ZA4204TX-E	1.0	94
	11,600	ZA4208TX-E	1.75	100
	11,600	ZA4204TX-ER	1.0	101
	11,600	ZA4208TX-ER	1.75	112

¹⁾ All models meet CE safety requirements and all TÜV requirements.



Accessory Options

Available by placing the following additional suffix at the end of the model number:

- K** = Skidbar
- M** = 4-wrench manifold
- R** = Roll cage

Page: 245



Pump Ratings

-Q suffix pumps are for 10,000 psi torque wrenches, and include spin-on couplers.

-E suffix pumps are for use with Enerpac SQD and HXD 11,600 psi torque wrenches, and include polarized lock-ring safety couplers.

▼ This is how a ZA4-Series pump model number is built up:



1 Product Type

Z = Pump Series

2 Motor Type

A = Air motor

3 Flow Group

4 = 60 in³/min @ 10,000 psi

4 Valve Type

2 = Torque Wrench Valve

5 Reservoir Size (useable capacity)

04 = 1.0 gallon

08 = 1.75 gallons

6 Valve Operation

T = Air operated valve with pendant

7 Voltage

X = Not applicable

8 Factory installed features and options

E = 11,600 psi coupler for use with HXD- and SQD-Series wrenches

Q = 10,000 psi coupler for use with S- and W-Series or other wrenches

K = Skidbar

M = 4-wrench manifold

R = Roll cage



How to order your ZA4-Series torque wrench pump

Ordering Example 1

Model No. ZA4208TX-QMR

10,000 psi pump for use with Enerpac S- and W-Series and other 10,000 psi torque wrenches, 1.75 gallon reservoir, 4-wrench manifold, and roll cage.

Refer to the torque wrench pump selection matrix for optimum wrench, pump and hose combinations.

Dimensions shown in inches.

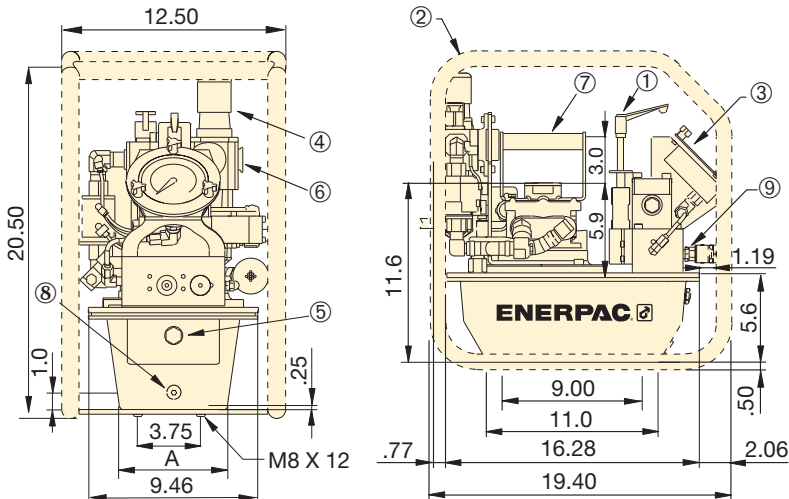

- ① User adjustable relief valve
- ② Roll bar cage (optional)
- ③ Gauge with overlays
- ④ Filter/lubricator/regulator
- ⑤ Oil level sight gauge
- ⑥ Air input 1/2" NPTF
- ⑦ Standard handle
- ⑧ Oil drain
- ⑨ 1/4"-18 NPTF Oil Outlet

ZA4-Series Torque Wrench Pumps

Reservoir Size (useable gallons)	A (in)
1	6.0
1.75	8.1

▼ Most hydraulic torque wrenches can be powered by the Enerpac ZA4-Series torque wrench pump.



ZA4 Performance										
Output Flow Rate					Dynamic Air Pressure Range	Air Consumption	Sound Level at 100 psi Dynamic	Relief Valve Adjustment Range		
(in ³ /min)										
100 psi	700 psi	5,000 psi	10,000 psi	11,600 psi	(psi)	(scfm)	(dBA)	(psi)		
600	500	80	60	55	60-100	20-100	80-95	1,400-10,000*		

* Pump type (-Q) shown.

ZA4T Torque Wrench Pump Options



Skidbar

- Provides greater pump stability on soft or uneven surfaces
- Provides two-handed lift

Accessory Kit No. *	Can be used on ZA4-Series torque wrench pumps
SBZ-4	1 and 1.75 gallon reservoir

* Add suffix **K** for factory installation. Skidbar weight 4.9 lbs.

Ordering Example:

Model No. ZA4208TX-QK



4-Wrench Manifold

- For simultaneous operation of multiple torque wrenches
- Can be factory installed or ordered separately

Accessory Kit No. *	Can be used on ZA4-Series torque wrench pumps
ZTM-E	for 11,600 psi torque wrenches
ZTM-Q	for 10,000 psi torque wrenches

* Add suffix **M** for factory installation.

Ordering Example:

Model No. ZA4208TX-QM

ZA4T Series



Reservoir Capacity:

1 and 1.75 gal.

Flow at 10,000 psi:

60 in³/min.

Air Consumption:

20-100 scfm

Maximum Operating Pressure:

10,000 and 11,600 psi



Gauge Overlay Kit

Gauge overlay kits are also available separately.

GT-4015 includes overlays for all SQD and HXD torque wrenches. **GT-4015-Q**

includes overlays for all S- and W-Series torque wrenches.



Roll Cage

- Protects pump
- Provides greater pump stability

Accessory Kit No. *	Can be used on ZA4-Series torque wrench pumps
ZRC-04	1 and 1.75 gallon reservoir

* Add suffix **R** for factory installation. Roll bar cage weight 7.5 lbs.

Ordering Example:

Model No. ZA4208TX-QR



Twin Torque Wrench Hoses

Use Enerpac THQ-700 series twin hoses with 10,000 psi pumps, or use THC-700 series twin hoses with 11,600 psi pumps.

10,000 psi	
19.5 feet long, 2 hoses	THQ-706T
39 feet long, 2 hoses	THQ-712T
11,600 psi	
19.5 feet long, 2 hoses	THC-7062
39 feet long, 2 hoses	THC-7122



Torque Wrench Couplers

For Enerpac torque wrench couplers see our "System Components" section in this catalog.

▼ Shown: GT-Series bolt tensioners



- Six load cells from 5/8" to 3 3/4" or from M16 to M95
- Twin ports for quick connection of multiple tools
- Only one size of bridge per size of load cell
- Detachable and rotational bridge simplifies tool positioning
- Full bridge window
- Piston stroke indicator
- Black surface treatment protects against corrosion
- Anti-slip grip for more secure handling
- Universal and multi-use tool

Accurate & Reliable Extreme Performance Bolt Tensioner



Pumps and Accessories

High pressure pumps, hoses and fittings matched for use with the Enerpac GT Bolt Tensioning system.

Page: 248



Minimum Stud Protrusion

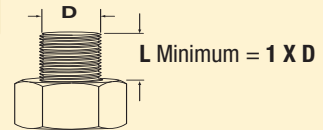

Ultra High Pressure

These products operate at ultra-high pressure, use only the specified fittings and hoses designed for these pressures.

Page: 250

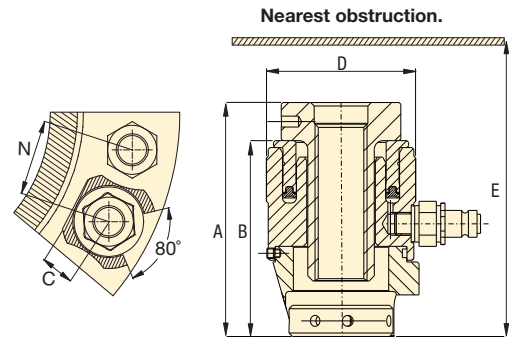

▼ GT2 Bolt Tensioner on a flange joint.



Threaded Fastener Range		Load Cell and Bridge Reference	Technical Data			Dimensions (in)				Weight (lbs)
			Cylinder Effective Area (in ²)	Load Capacity (ton)	Stroke (in)	A	B	C	D	
(in)	(mm)									
5/8" - 1"	M16-M30	GT1-LCB	2.32	25.2	0.39	5.31	4.45	1.06	3.39	6.60
1 1/8" - 1 1/2"	M30-M39	GT2-LCB	4.15	45.1	0.39	5.35	4.37	1.38	4.21	9.02
1 1/2" - 2"	M39-M52	GT3-LCB	7.95	86.4	0.39	6.30	4.96	1.81	5.43	15.40
2" - 2 1/2"	M52-M68	GT4-LCB	15.16	164.9	0.39	7.09	5.55	2.44	6.85	26.84
2 1/2" - 3 1/4"	M68-M80	GT5-LCB	23.37	254.1	0.39	7.95	6.18	3.07	8.27	41.14
3 1/4" - 3 3/4"	M80-M95	GT6-LCB	29.41	319.8	0.39	8.62	6.81	3.23	9.45	61.16

GT-Series Hydraulic Bolt Tensioners

Load Cell and Bridge Reference	Thread Size	Adaptor Kit Model Number	Pitch Between Bolts N (in)	Minimum Height E (in)	Weight (lbs)
GT1-LCB	M16 x 2	GT1PM-NRS01620	2.17	6.65	3.48
	M18 x 2.5	GT1PM-NRS01825	2.20	6.50	3.32
	M20 x 2.5	GT1PM-NRS02025	2.24	6.50	3.15
	M24 x 3	GT1PM-NRS02430	2.32	6.46	2.88
	M27 x 3	GT1PM-NRS02730	2.44	6.57	2.55
	M30 x 3.5	GT1PM-NRS03035	2.56	6.69	2.22
	5/8" 11UN	GT1P-NRS0625U11	2.17	6.65	3.45
	3/4" 10UN	GT1P-NRS0750U10	2.20	6.50	3.17
	7/8" 9UN	GT1P-NRS0875U09	2.32	6.46	2.86
	1" 8UN	GT1P-NRS1000U08	2.44	6.57	2.68
1 1/8" 8UN	GT1P-NRS1125U08	2.56	6.69	2.31	
GT2-LCB	M30 x 3.5	GT2PM-NRS03035	2.80	6.81	5.68
	M33 x 3.5	GT2PM-NRS03335	2.91	6.85	5.21
	M36 x 4	GT2PM-NRS03640	3.03	6.97	4.77
	M39 x 4	GT2PM-NRS03940	3.15	7.09	4.25
	1 1/8" 8UN	GT2P-NRS1125U08	2.80	6.81	5.81
	1 1/4" 8UN	GT2P-NRS1250U08	2.91	6.85	5.32
	1 3/8" 8UN	GT2P-NRS1375U08	3.03	6.97	4.84
1 1/2" 8UN	GT2P-NRS1500U08	3.15	7.09	4.29	
GT3-LCB	M39 x 4	GT3PM-NRS03940	3.62	8.35	12.50
	M42 x 4.5	GT3PM-NRS04245	3.78	8.46	11.77
	M45 x 4.5	GT3PM-NRS04545	3.90	8.58	10.96
	M48 x 5	GT3PM-NRS04850	4.13	8.50	10.25
	M52 x 5	GT3PM-NRS05250	4.25	8.66	9.20
	1 1/2" 8UN	GT3P-NRS1500U08	3.62	8.35	12.56
	1 5/8" 8UN	GT3P-NRS1625U08	3.78	8.46	11.70
	1 3/4" 8UN	GT3P-NRS1750U08	3.90	8.58	10.89
	1 7/8" 8UN	GT3P-NRS1875U08	4.13	8.50	10.10
	2" 8UN	GT3P-NRS2000U08	4.25	8.66	9.17
GT4-LCB	M52 x 5	GT4PM-NRS05250	4.65	9.45	23.63
	M56 x 5.5	GT4PM-NRS05655	4.76	9.61	22.22
	M60 x 5.5	GT4PM-NRS06055	4.88	9.76	20.77
	M64 x 6	GT4PM-NRS06460	5.00	9.92	19.32
	M68 x 6	GT4PM-NRS06860	5.12	10.08	17.80
	2" 8UN	GT4P-NRS2000U08	4.65	9.45	23.63
	2 1/4" 8UN	GT4P-NRS2250U08	4.76	9.61	21.23
2 1/2" 8UN	GT4P-NRS2500U08	5.00	9.92	18.63	
GT5-LCB	M68 x 6	GT5PM-NRS06860	5.71	10.94	38.02
	M72 x 6	GT5PM-NRS07260	5.87	11.10	36.06
	M76 x 6	GT5PM-NRS07660	5.98	11.26	34.03
	M80 x 6	GT5PM-NRS08060	6.38	11.54	32.01
	2 1/2" 8UN	GT5P-NRS2500U08	5.67	10.79	39.16
	2 3/4" 8UN	GT5P-NRS2750U08	5.87	11.10	35.84
	3" 8UN	GT5P-NRS3000U08	5.98	11.26	32.45
3 1/4" 8UN	GT5P-NRS3250U08	6.38	11.54	28.86	
GT6-LCB	M80 x 6	GT6PM-NRS08060	6.65	12.28	49.02
	M85 x 6	GT6PM-NRS08560	6.65	12.28	46.20
	M90 x 6	GT6PM-NRS09060	7.01	12.48	42.57
	M95 x 6	GT6PM-NRS09560	7.13	12.68	39.69
	3 1/4" 8UN	GT6P-NRS3250U08	6.65	12.28	45.56
	3 1/2" 8UN	GT6P-NRS3500U08	7.01	12.48	41.43
3 3/4" 8UN	GT6P-NRS3750U08	7.13	12.68	36.94	

GT Series



Bolt Range:

5/8" - 3 3/4" | M16-M95

Load:

0-319.8 tons

Maximum Operating Pressure

21,750 psi



How to Order

To provide maximum flexibility Load Cell and Bridges are ordered separately from Adaptor Kits.

Example, to order a complete tensioner for a 1" threaded bolt order:

1 x Load Cell and Bridge: **GT1-LCB**

1 x Adaptor Kit: **GT1P-NRS1000U08**



Bolting Integrity Software

A comprehensive on-line software solution for Bolted Joint integrity.

Integral databases hold data for:

- BS1560, MSS SP44, API 6A and 17D flanged joints
- Common gasket materials and configurations
- Comprehensive range of bolt materials
- Comprehensive range of lubricants
- Enerpac's Controlled Bolting Equipment including: Torque Multipliers, Hydraulic Wrenches and Bolt Tensioning tools

Custom Joint information can also be entered.

The software offers Tool selection, Bolt Load calculations and Tool pressure settings, as well as, a combined Application data sheet and Joint completion report.

www.enerpac.com

▼ Shown: HPT-1500



HPT Series

Reservoir Capacity:

155 in³

Flow at 10,000 psi:

.037-.99 in³/stroke

Maximum Operating Pressure:

21,750 psi (1500 bar)

- Lightweight and portable high-pressure hand pump
- Two-speed operation displaces a larger volume of oil per stroke, reducing cycle times for many testing applications
- Includes a gauge and coupler for direct connection to GT-Series bolting tools
- Integrated relief valve set at 21,750 psi



Applications

The Enerpac HPT high-pressure Hand Pump is ideally suited for use with hydraulic bolt tensioning tools and hydraulic nuts.

Page: 246



Ultra High Pressure

These products operate at ultra-high pressure, use only the specified fittings and hoses designed for these pressures.

Page: 250

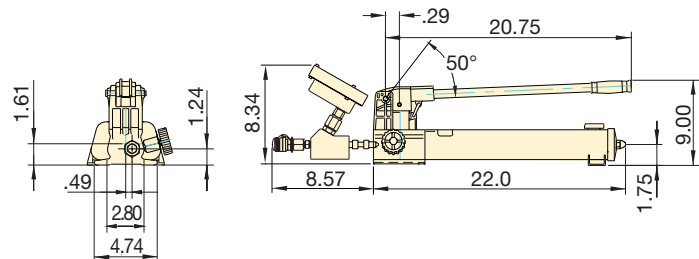

▼ 21,750 PSI ULTRA HIGH PRESSURE PUMP

Model Number	Description	Usable Oil Capacity (in ³)	Oil Displacement per Stroke (in ³)		Pressure Rating (psi)		Weight (lbs)
			1 st stage	2 nd stage	1 st stage	2 nd stage	
HPT-1500	High Pressure Hand Pump with Gauge	155	.99	0.037	200	21,750	19

ZUTP-Series, Electric Tensioning Pump

▼ Shown: ZUTP-1500B



ZUTP Series

Reservoir Capacity:

1 gallon

Flow at Rated Pressure:

20.0 in³/min.

Maximum Operating Pressure:

21,750 psi



Ultra High Pressure

These products operate at ultra-high pressure, use only the specified fittings and hoses designed for these pressures.

Page: 250

- High efficiency Universal Motor draws lower amps for superior performance in remote locations with low power quality
- Two-stage pump design provides high flow at low pressure for fast system fills and controlled flow at high pressure for safe and accurate operation
- Compact and lightweight design fits through tight openings and provides easy handling
- Panel mounted 6" pressure gauge, with polycarbonate cover, is set into the protective metal shroud for improved visibility and safety
- Panel mounted user adjustable valve for safe and precise pressure control
- Safety relief valve limits output pressure

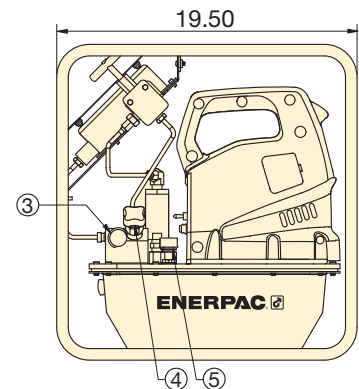
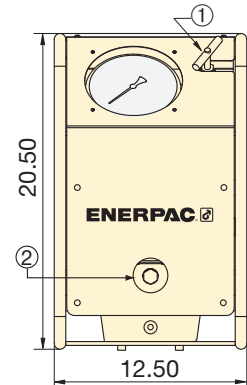

- ① Release Valve
- ② Sight Glass
- ③ 1/4" BSPM Outlet Port
- ④ User Adjustable Pressure Control Valve
- ⑤ Breather

21,750 PSI HIGH PRESSURE PUMP

Pump Type	Useable Oil Capacity (gal)	Valve Type	Model Number ¹⁾	Output Flow Rate at 0 psi (in ³ /min)	Output Flow Rate at 21,750 psi (in ³ /min)	Motor Electrical Specification	Sound Level (dBA)	Weight with oil (lbs)
High pressure	1.0	Manual	ZUTP-1500B	230	20	115 VAC, 1-ph	89	65
			ZUTP-1500E ²⁾			230 VAC, 1-ph		
			ZUTP-1500I ³⁾			230 VAC, 1-ph		

¹⁾ All models meet CE safety requirements and all TÜV requirements.
²⁾ European plug and CE EMC directive compliant.

³⁾ With NEMA 6-15 plug.
⁴⁾ Add suffix "H" for factory installation of Heat Exchanger.

ATP-Series Ultra High Pressure Air Pump

ENERPAC 
POWERFUL SOLUTIONS. GLOBAL FORCE.

▼ Shown: ATP-1500



ATP Series



Reservoir Capacity:

1.0 gallon

Flow at Rated Pressure:

4 in³/min.

Maximum Operating Pressure:

21,750 psi









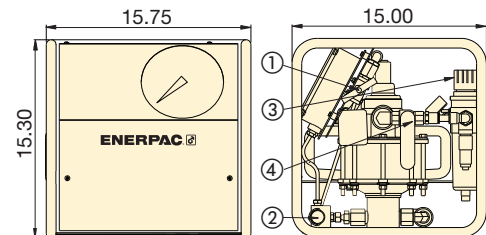
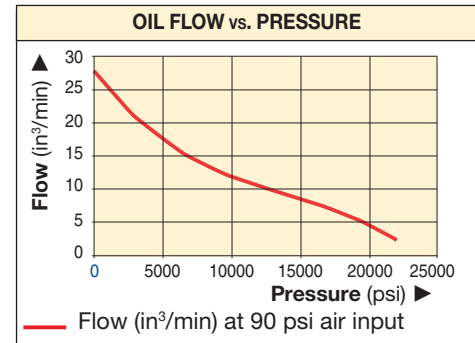

These products operate at ultra-high pressure, use only the specified fittings and hoses designed for these pressures.

- General purpose, high pressure air driven pump unit for products requiring up to 21,750 psi hydraulic pressure
- Compact, lightweight, rugged steel frame for protection and easy handling
- Pre-lubricated pump element, does not require an airline lubricator
- Easily adjustable output pressure control
- Integrated and protected easy to read glycerin filled gauge
- Safety relief valve limits output pressure
- ATEX Certified

The ATP-series pump was tested and certified according to the Equipment Directive 94 / 9 / EC "ATEX Directive". The explosion protection is for equipment group II, equipment category 2 (hazardous area zone 1), in gas and/or dust atmospheres. The ATP-series pump is marked with: Ex II 2 GD ck T4.



- ① HPT Shut-off Valve
- ② 1/4" BSPP HPT Out Port
- ③ Filter/Regulator
- ④ Air On/Off Valve

Model Number	Hoses	End 1	End 2	Length (ft)	Description	Fittings	Complete Set	Female Half	Male Half
HT-1503		1/4 BSPM 120° Cone	1/4 BSPM 120° Cone	3.28	Quick Disconnect Coupler*		B150	BR150	BH150
HT-1510		1/4 BSPM 120° Cone	1/4 BSPM 120° Cone	9.84	Quick Disconnect Coupler and Adaptor Kit*		BW150AW	—	—
HT-1503HR*		BH150	BR150	3.28	Quick Disconnect Blanking Coupler Set*		B150B	—	—
HT-1510HR*		BH150	BR150	9.84	Quick Disconnect Blanking Coupler Set*		B150B	—	—

* Includes dust caps

* Includes dust caps

Pump Type	Useable Oil Capacity (gal)	Model Number	Pressure Rating (psi)	Output Flow Rate at 0 psi (in ³ /min)	Output Flow Rate at 21,750 psi (in ³ /min)	Air Pressure Range (psi)	Air Consumption (sfcms)	Sound Level (dBA)	Weight (lbs)
High pressure	1.0	ATP-1500	21,750	26	4	80-90	70	70	65

Hydraulic Nut Cutters

▼ Shown from left to right: NC-3241, NC-1319, NC-1924



NC, STN Series



Capacity:
5-90 tons

Hexagon Nut Range:
0.5-2.88 inches

Maximum Operating Pressure:
10,000 psi

Enerpac Nut Cutters



Nut Cutters include a spare chisel, a spare set screw and the wrench used to secure the chisel. A CR-400 coupler is standard.

- Compact and ergonomic design, easy to use
- Unique angled head allows flush access
- Single-acting, spring return cylinder
- Heavy-duty chisels can be reground
- Applications include servicing trucks, piping industry, tank cleaning, petrochemical, steel construction and mining

Nut Cutter Sets

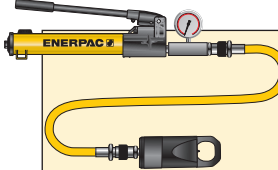

Hydraulic Nut Cutters are available as sets (pump, tool, gauge, adaptor and hose).

Set Model Number	Splitter Model Number	Pump Model Number
STN-1924H	NC-1924	P-392
STN-2432H	NC-2432	P-392
STN-3241H	NC-3241	P-392



◀ Easily removing rusty nuts during railroad construction is just one of many application examples for the Enerpac Nut Cutters.

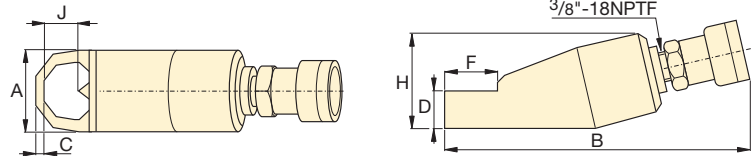

Hexagon Nut Range (in)	Bolt Range (in)	Capacity (ton)	Oil Capacity (in ³)	Model Number	Dimensions (in)							Weight (lbs)	Replacement Chisel Model Number
					A	B	C	D	F	H	J		
.50-.75	.31-.50	5	.92	NC-1319	1.57	7.87	.24	.75	1.10	1.89	.83	1.8	NCB-1319
.75-.94	.50-.63	10	1.22	NC-1924*	2.17	8.94	.32	.98	1.50	2.80	1.00	4.4	NCB-1924
.94-1.13	.63-.88	15	3.66	NC-2432*	2.60	10.24	.39	1.22	1.93	2.99	1.30	6.6	NCB-2432
1.13-1.56	.88-1.13	20	4.88	NC-3241*	2.95	11.26	.59	1.38	2.60	3.50	1.69	9.7	NCB-3241
1.56-2.00	1.13-1.38	35	9.46	NC-4150	3.78	12.80	.83	1.77	2.87	4.29	2.13	18.0	NCB-4150
2.00-2.25	1.38-1.50	50	14.64	NC-5060	4.17	14.41	1.06	2.13	3.63	4.96	2.38	26.0	NCB-5060
2.38-2.88	1.50-1.88	90	30.00	NC-6075	6.14	14.43	1.06	2.95	4.33	7.09	3.07	75.1	NCB-6075

Ordering Notes: Maximum allowable hardness to split is HRc-44. Not to be used on square nuts. Larger sizes available upon request.

* Available as Tool-Pump set, see note on this page.

▼ Shown: NS-7080, NS-70105



Power and Precision

High Performance Nut Splitter

- Specially designed to suit standard ANSI B16.5 / BS1560 flanges
- Single-acting, spring return cylinder
- Tri-blade technology provides three cutting surfaces on a single blade
- Interchangeable heads provide maximum nut range flexibility
- Preset scale allows controlled blade extension, which avoids damage to bolt threads
- Grip tape and handle included for more secure maneuverability
- Nickel-plated cylinder body for excellent corrosion protection and improved durability in harsh environments
- Internal Pressure Relief Valve for overload protection



Blade Cutting Depth Scale

Adjustable cutting depth scale for controlled blade extension, which avoids damage to bolt threads.

The scale indicates the bolt range in metric and imperial values on each cutting head.



Hydraulic Nut Cutters

The NC-Series models are available featuring an angle-head design for 0.50" -2.88" hexagon nuts.

Page: 251



FS-Series Spreaders

FS-Series Flange Spreaders provide quick and easy joint separation using hydraulic or mechanical force.

Page: 254



ATM Flange Alignment Tools

The ATM series provides safe high-precision flange alignment tools that fit most commonly used ANSI, API, BS, and DIN flanges.

Page: 256



◀ Heavily corroded and weathered nuts are quickly split and removed using an NS-Series Nut Splitter.

Hydraulic Nut Splitters



Nut Splitter Sets

To provide maximum flexibility, NS-Series Nut Splitters can also be ordered in sets (NS-xxxSx). Select Nut Splitter size and pump style from the chart below.

To order additional Cutting Heads (NSH-xxxxxx), Cylinders (NSC-xxx) or Replacement Blades (NSB-xxx), see Selection Chart below.

SET SELECTION:

- 1 Select your Nut Splitter
- 2 Select your pump type

NS Series



Capacity:

103.2-192.5 tons

Hexagon Nut Range:

2.75-5.38 inches

Maximum Operating Pressure:

10,000 psi

Nut Splitter Model Number	Set Model Number	Pump Options				Accessories Included			
		Hand Pump Model No.	Air Pump Model No.	Cordless Pump Model No. ¹⁾	Electric Pump Model No.	Gauge Model No.	Gauge Adaptor Model No.	Hose Model No.	Storage Case Model No.
NS-70105	NS-70105SH	P392	-	-	-	GP-10S	GA-2	HC-7206	CM-4
NS-70105	NS-70105SA	-	XA-11G*	-	-	integrated*	-	HC-7206	CM-4
NS-70105	NS-70105SCB	-	-	XC-1202MB	-	GA45GC		HC-7206	CM-4
NS-70105	NS-70105SE	-	-	-	PUD-1100B	GP-10S	GA-2	HC-7206	CM-7
NS-110130	NS-110130SH	P802	-	-	-	GP-10S	GA-2	HC-7206	CM-4
NS-110130	NS-110130SA	-	XA-11G*	-	-	integrated*	-	HC-7206	CM-4
NS-110130	NS-110130SCB	-	-	XC-1202MB	-	GA45GC		HC-7206	CM-4
NS-110130	NS-110130SE	-	-	-	PUD-1100B	GP-10S	GA-2	HC-7206	CM-7

¹⁾ XC Cordless Pump includes 115 V charger, for 230 V charger replace the "B" in the model number with an "E".

* XA-11G air pump features an integrated pressure gauge.

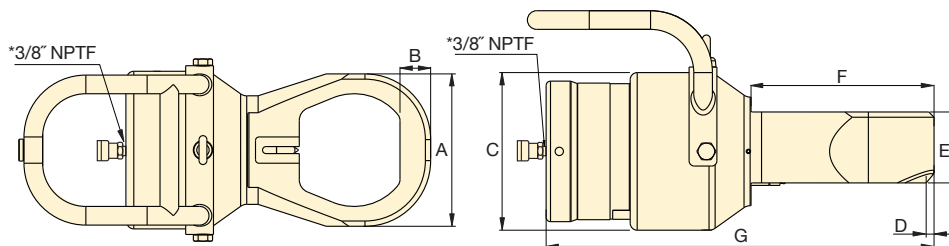

Hexagon Nut Range**	Bolt Range	Cap.	Oil Cap.	Model Number*	Dimensions (in)							Weight (lbs)	NS Cylinder	NS Cutting Head	Replacement Blade
					A	B	C	D	E	F	G				
(in)	(in)	(ton)	(in ³)												
2.75-3.13	1.75-2.00	103.2	23.0	NS-7080	5.2	1.1	7.1	0.3	3.2	7.3	16.2	81.4	NSC-70	NSH-7080	NSB-70
2.75-3.50	1.75-2.25	103.2	23.0	NS-7085	5.7	1.2	7.1	0.3	3.2	7.7	16.6	82.7	NSC-70	NSH-7085	NSB-70
2.75-3.88	1.75-2.50	103.2	23.0	NS-7095	6.3	1.3	7.1	0.3	3.2	7.9	17	84.9	NSC-70	NSH-7095	NSB-70
2.75-4.25	1.75-2.75	103.2	23.0	NS-70105	6.9	1.4	7.1	0.4	3.2	8.2	17.5	87.1	NSC-70	NSH-70105	NSB-70
4.25-4.63	2.75-3.00	192.5	50.0	NS-110115	7.4	1.4	9.2	0.1	4.4	9.2	18.6	151.6	NSC-110	NSH-110115	NSB-110
4.25-5.38	2.75-3.50	192.5	50.0	NS-110130	8.6	1.6	9.2	0.1	4.4	9.5	19.4	158.3	NSC-110	NSH-110130	NSB-110

* NS-Series Nut Splitters ship in two cases: One containing the NSC Cylinder and one containing the NSH Cutting Head. Assembly required.

** Maximum allowable hardness to split is HRc-44.

Pin Type Hydraulic Flange Spreaders

▼ Shown: FS-56



- Lightweight, ergonomic design for ease of use
- Adjustable jaw widths from 2.75" to 8.50" for a wide range of applications
- Single-acting, spring return RC Series cylinders for fast trouble-free operation

FS, STF Series



Capacity:
5-10 tons

Spread:
2.75 - 8.50 inches

Maximum Operating Pressure:
10,000 psi

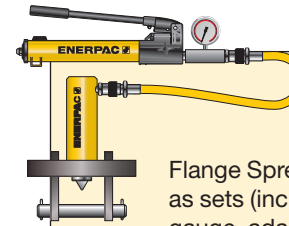

Flange Spreader Sets*

Both Hydraulic Flange Spreaders are available as sets (includes pump, tool, gauge, adaptor and hose).

Set Model Number	Spreader Model Number	Pump Model Number
STF-56H	FS-56	P-392
STF-109H	FS-109	P-392
STF-109A	FS-109	PATG-1102N



Wedge Spreaders

Friction-free, smooth and parallel wedge movement with unique interlock wedge design. Eliminates flange damage and risk of spreading arm failure.

Page: 255

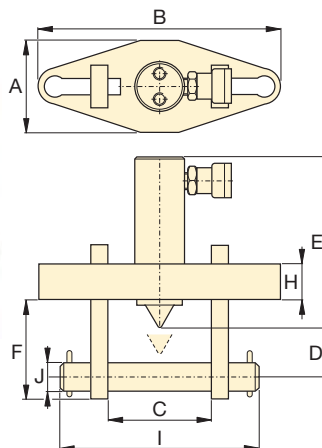
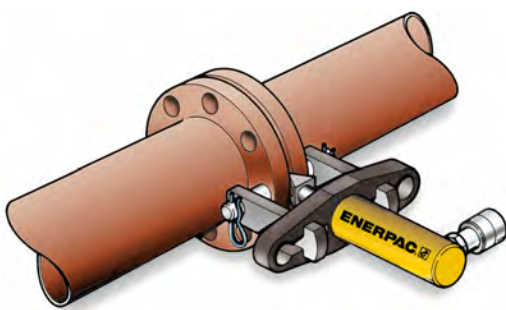

Flange Spreader Matching Chart

ASA Rating (psi)	Pipe Size (in)	
	FS-56	FS-109
150	5-20	22-42
300	2.50-14	16-28
400	2.50-12	14-24
500	2.50-10	12-20
900	.50-6	8-16
1500	.50-3.50	4-8
2500	.50-2.50	3-4

Maximum Flange Thickness (in)	Stud Size (in)	Standard Wedge (in)	Cap. (ton)	Stroke (in)	Oil Cap. (in ³)	Model Number	Dimensions (in)										Weight (lbs)
							A	B	C		D	E	F	H	I	J	
									Min.	Max.							
2 x 2.25	.75-1.13	.13-1.13	5	1.50	1.50	FS-56*	3.00	8.25	2.75	6.10	1.28	7.71	3.45	1.00	8.10	.75	26
2 x 3.63	1.25-1.63	.13-1.13	10	2.13	4.80	FS-109*	4.25	11.00	4.10	8.50	1.98	6.00	4.50	1.50	10.75	1.25	40

* Available as Tool-Pump Set, see note on this page.

Hydraulic and Mechanical Industrial Spreaders

▼ Shown: FSH-14 and FSM-8 with safety blocks SB1



- Integrated wedge concept: friction-free, smooth, parallel wedge movement eliminates flange damage and spreading arm failure
- Unique interlocking wedge design: no first step bending and risk of slipping out of joint
- Requires very small access gap of only .24 inch (6 mm)
- Stepped spreader arm design: each step can spread under full load
- Few moving parts means durability and low maintenance
- Safety block SB-1 and ratchet spanner SW-22 included with FSM-8
- Safety block and Enerpac RC-102 cylinder included with FSH-14

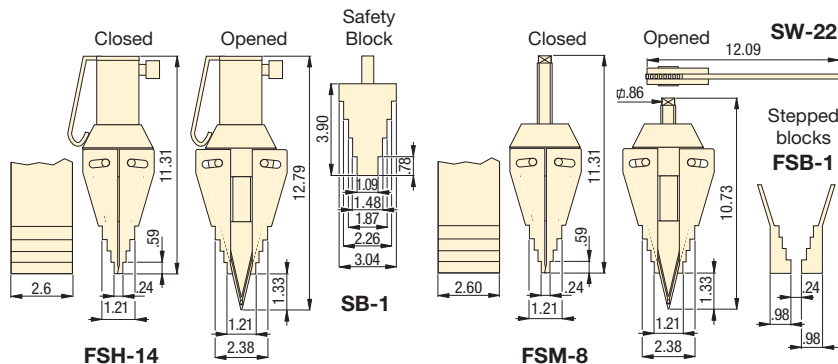

Max. Spreading Force (ton)	Model Number	Tip Clearance (in)	Max. Spread ¹⁾ (in)	Type	Oil Capacity (in ³)	Weight (lbs)
8	FSM-8	.24	3.16	Mechanical	-	14.3
14	FSH-14*	.24	3.16	Hydraulic	4.76	15.7

¹⁾ Using stepped blocks FSB-1.

* Available as Tool-Pump Set, see note on this page.

FSM/FSH/STF Series

Tip Clearance / Maximum Spread*:
0.24/3.16 inches

Maximum Spread Force:
8-14 tons

Maximum Operating Pressure:
10,000 psi (FSH-14)

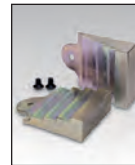

Stepped Blocks FSB-1

Use this pair of stepped blocks to increase wedge opening up to 3.16 in. (81 mm). Fits both FSH-14 and FSM-8.

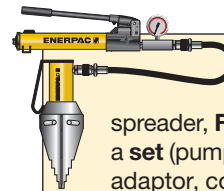

Flange Spreader Sets

The hydraulic flange spreader, FSH-14, is available as a set (pump, tool, gauge, gauge adaptor, couplers and hose) for your ordering convenience

Spreader Model No.	Handpump Model No.	Set Model Number
FSH-14	P-392	STF-14H

▼ Two FSH-14 spreaders used simultaneously with Enerpac handpump, hoses and AM-21 split-flow manifold.



▼ From left to right: **ATM-4**, **ATM-9**, **ATM-2**



The faster, simpler and safer way to align flanges

- Enerpac ATM-Series tools rectify twist and rotational misalignment quickly, safely, and without the need for an external power source
- Appropriate for use on most ANSI, API, BS and DIN flanges
- No slings, hooks or lifting gear required
- Can be installed and used in any position (horizontally or vertically)
- Portable, lightweight design enables easy transport and use, even in remote locations



Adjustable Reach

The highly adjustable reach of the wing and drop leg on the **ATM-4** and **ATM-9** allows precise alignment.



Gauge and Adaptor

The **ATM-9** includes P-142 hand pump and HC-7206C 6 ft. long hose. Enerpac recommend the use of the pressure gauge **GP-10S** and gauge adaptor **GA-4** for easy mounting of the gauge onto your system.

Page: 131

▼ The compact **ATM-2** is actuated by simply hand turning the crank.



▼ The **ATM-9** is shown here with optional pressure gauge and gauge adaptor.



ATM-Series, Flange Alignment Tools



Applications

Enerpac ATM-Series Tools help correct flange misalignment, and allow bolts to be placed into joints. This alignment takes place during pipework construction, or maintenance.

These tools provide pipe installers and maintenance personnel with some of the simplest, safest and most productive solutions available for flange alignment in the market today.

- ① Extendable wing provides usage on wide variety of flanges.
- ② Portable, light weight design enables easy transport and use.
- ③ Hand-adjustable base for easy positioning by a single operator.
- ④ Safety strap helps provide secure operation from a horizontal or vertical position.

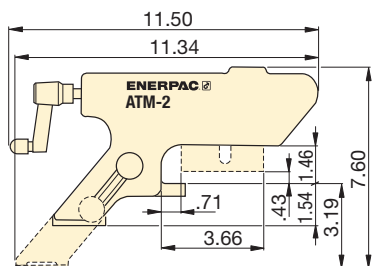
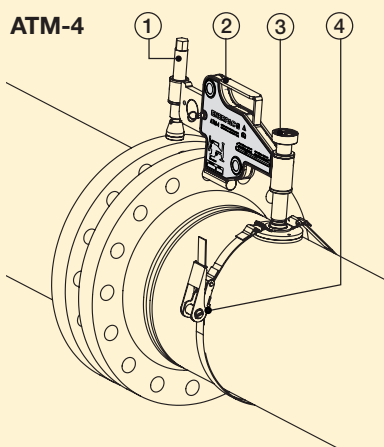

ATM-2

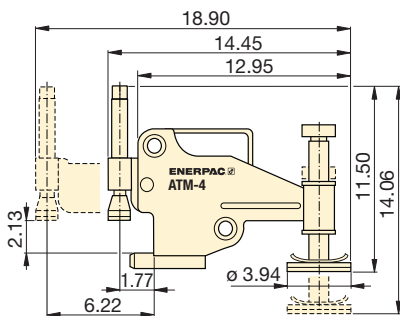

ATM-4

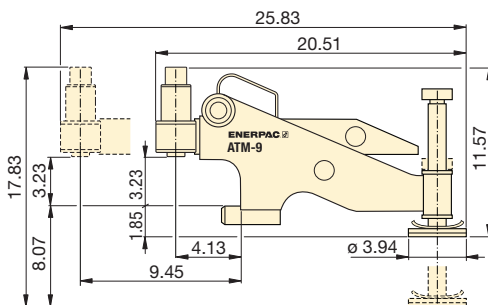

ATM-9

ATM Series



Minimum Bolt Size:

.63-1.24 inches

Flange Wall Thickness:

.55-9.00 inches

Maximum Lifting Force:

1-10 tons



Cylinder-Pump Sets

Hydraulic cylinders, jacks and lifting wedges can also be used to assist in pipe line positioning and aligning.

Page: 52



Pipe Flange Face Tool

The portable, hand powered tool FF-120 makes even the hardest to reach pipe flanges resurfaceable in a safe and convenient way.

Page: 258

▼ The ATM-Series – the faster, simpler and safer way to align flanges.



Maximum Lifting Force (ton)* (kN)*	Model Number	Minimum Bolt Size**		Flange Wall Thickness (max)		Wt. (lbs)	
		(in)	(mm)	(in)	(mm)		
1	10	ATM-2	.63	16	.55 - 3.29	14 - 82	3.5
4	40	ATM-4	.95	24	1.18 - 5.23	30 - 133	19
10	90	ATM-9**	1.24	31,5	3.66 - 9.00	93 - 228	32

* At 10,000 psi maximum operating pressure.

** ATM-9 includes an Enerpac hand pump and hydraulic hose (gauge and adaptor sold separately). ATM-9 weight includes tool only.

▼ Shown: FF-120



Safe, efficient and accurate refacing of flat pipe flange surfaces

- Refacing made easy — hand-operated machine tool can be set up anywhere without the need for air, electric or hydraulic power support
- Lightweight and portable — easily transported to remote locations for increased productivity
- Adjustable cutting range for flange diameters between 1-12 inches [25,4-304,8 mm]
- Interchangeable collets for ID mounting range from 1-6 inches allowing the user to work on many different flanges with minimal time between set-ups
- Interchangeable lead screws suitable for refacing damaged raised-face (RF), flat-face (FF) or lens-ring joint flanges
- Tool body with expanding collets centers itself providing real concentric operation



Complete In-Wheeled Carrying Case

The **FF-120** comes as portable set (15 kg). Can be transported, easy set-up

and operated by a single technician. Set includes:

- **FFL**-kit with locators, O-Rings and extensions
- **FSS**-kit with feed screw and nut 1/2"-20 UN for surface roughness Ra 64 - 96 µin.
- **FSF**-kit with feed screw and nut 1/2"-11 UNF for surface roughness Ra 125 - 250 µin.



Joint Separation Tools

FS and FSH-Series

parallel wedge spreaders provide quick and easy joint separation using hydraulic or mechanical force.

Page: 254

▼ The Enerpac FF-120 used to face a pipe flange.



Joint Assembly Tools

Rectify twist and rotational alignment without additional stress in pipe lines using the **ATM-Series** flange alignment tools.

Page: 256

Quick Face, Mechanical Flange Face Tool



QuickFace, Mechanical Flange Face Tool

Portable, hand powered tool makes even the hardest to reach pipe flanges resurfaceable in a safe and convenient way.

Makes refacing easy

A simple and cost effective solution – the FF-120 turns a two man operation with heavy equipment, compressors and portable generators into a one man job.

The FF-120 has interchangeable lead screws that make it suitable for resurfacing damaged flat-faced, raised-face or lens-ring joint flanges to the high safety standards required. After selecting the correct lead screw for the operation, the tool body is inserted in the pipe end and centers itself with adjustable locators to provide real concentric operation.

The tool arm is then rotated by hand using a worm-gear mechanism to provide a perfect spiral “gramophone” finish.

The tool can be adjusted with a calibrated slide to define cut depth and the correct finish.

Surface finish and accuracy

A serrated finish with 30-55 grooves per inch and a resultant roughness of between Ra 125-250 micro inches (3,18-6,35 µm).

The FF-120 has the same precision and quality of finish as a lathe.

Cost effective solution

Small and portable enough to be a permanent addition to your equipment range, Enerpac’s FF-120 is the perfect solution to all of your small diameter facing problems.

FF Series



Pipe Flange Cutting Diameter Range:
1-12 in (25-305 mm)

Internal Pipe Mounting Diameter Range:
1-6 in (25-152 mm)

Average Roughness:
125-250 µin (3,18-6,35) µm

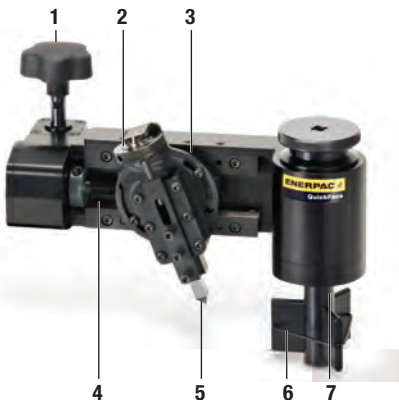

- 1 Hand-operated cold work tool – no need for external power and hot work permits.
- 2 Calibrated cross slide for accurate cutting control.
- 3 Adjustable cutting head for reface of flat flange surfaces of pipes with flange OD facing range ϕ 1-12 inch [25,4-304,8 mm].
- 4 Interchangeable lead screws enable selection of surface finish between Ra 125-250 µin.
- 5 Utilizes standard 3/8 inch or 10 mm tool steel.
- 6 Range of interchangeable collets allow the tool to accommodate ϕ 1 - 6 inch [25,4 - 152,4 mm] pipe ID.
- 7 Tool body with expanding collets centers in the bore ensuring concentric and accurate set-up.

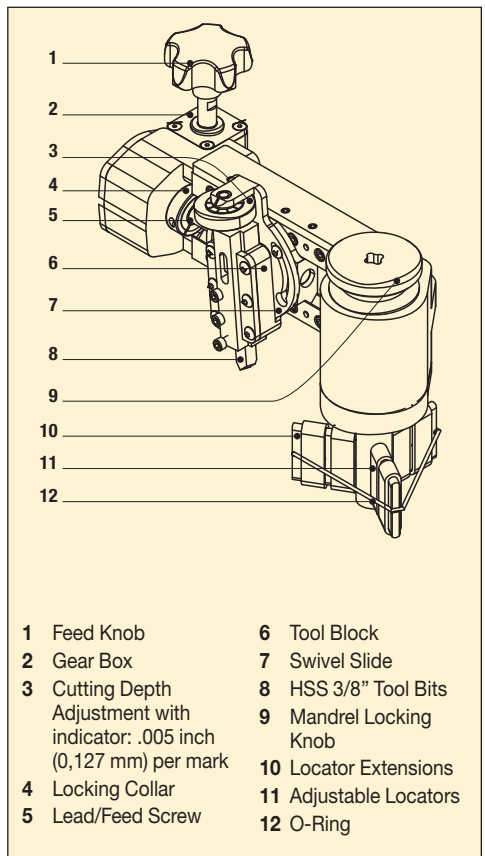

- | | |
|--|------------------------|
| 1 Feed Knob | 6 Tool Block |
| 2 Gear Box | 7 Swivel Slide |
| 3 Cutting Depth Adjustment with indicator: .005 inch (0,127 mm) per mark | 8 HSS 3/8" Tool Bits |
| 4 Locking Collar | 9 Mandrel Locking Knob |
| 5 Lead/Feed Screw | 10 Locator Extensions |
| | 11 Adjustable Locators |
| | 12 O-Ring |

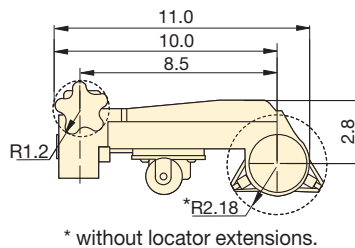
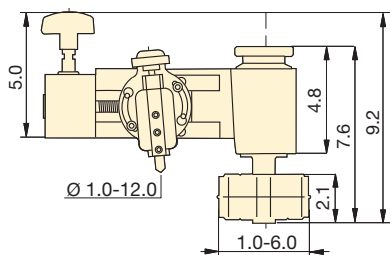

▼ TOOL SELECTION CHART

Pipe Flange Cutting Diameter Range		Internal Pipe Mounting Diameter Range		Average Roughness (Ra µ)		Model Number	Wt. (lbs)
(in)	(mm)	(in)	(mm)	(in)	(m)		
1.0-12.0	25,4-304,8	1.0-6.0	25,4-152,4	125-250	3,18-6,35	FF-120	15
				60-100*	1,52-2,54*		

* When using fine thread feed screw, FF120FSF.

▼ The Enerpac FF-120 Quick Face has same precision and quality of finish as powered machines.

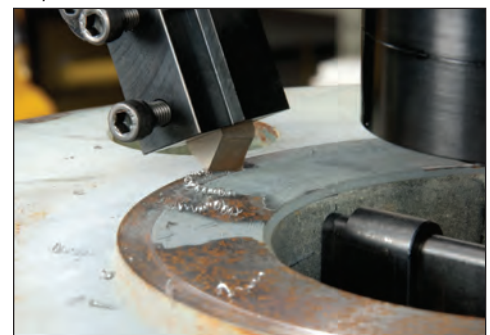

Enerpac's Heavy Lifting Technology provides customers with tailored solutions, combining hydraulics, steel fabrication and electronic controls for safe, precise movement of heavy loads.

With more than 50 years supporting industrial markets, Enerpac has gained the unique and in-depth expertise that is respected by industrial professionals around the world.

Enerpac's complete line of standard and customized products and a unique systems approach offers the benefits of safety and efficiency to applications where high forces are required.

Whether constructing a signature bridge, performing a heavy load out, fabricating a new ship or positioning a large transformer, Enerpac will supply the hydraulic solutions to get the job done safely and efficiently.

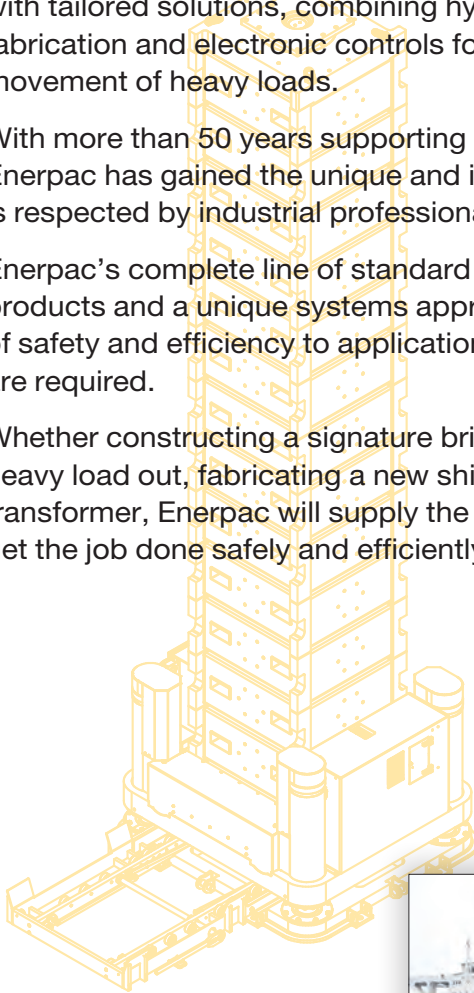

Jacking with high capacity precision control



Synchronous superlift and launch



Precision lift and position of heavy loads



Synchronous hoisting and load positioning

EXPERIENCE and EXPERTISE



HYDRAULICS

Moving heavy loads with hydraulic systems is our core expertise. Enerpac designs, manufactures, integrates and tests complete hydraulic systems in house.



ELECTRONICS







Our in-house team of electrical engineers combine their knowledge of heavy lifting equipment to tailor system controls to match unique project requirements.



STEEL FABRICATION

Enerpac has a dedicated facility for steel fabrication and welding. We design and manufacture custom structures used in demanding heavy-lifting applications.

Heavy Lifting Equipment Section Overview

Capacity (tons)	Capabilities	Series		Page
140-280	Skidding Systems	HSK		262 ▶
17-1405	Heavy Lifting Strand Jacks	HSL		264 ▶
67-1178	Hydraulic Gantries	SL SBL MBL		266 ▶
140-840	Jack-Up Systems	JS		268 ▶
67	Self-Propelled Modular Transporter	SPMT		270 ▶
	Custom Solutions			272 ▶



Contact Enerpac!

Contact the Enerpac office nearest to you for advice and technical assistance in the layout of your ideal solution or visit us on the web:
enerpac.com/contact-us

▼ Shown: HSK1250 Skidding System

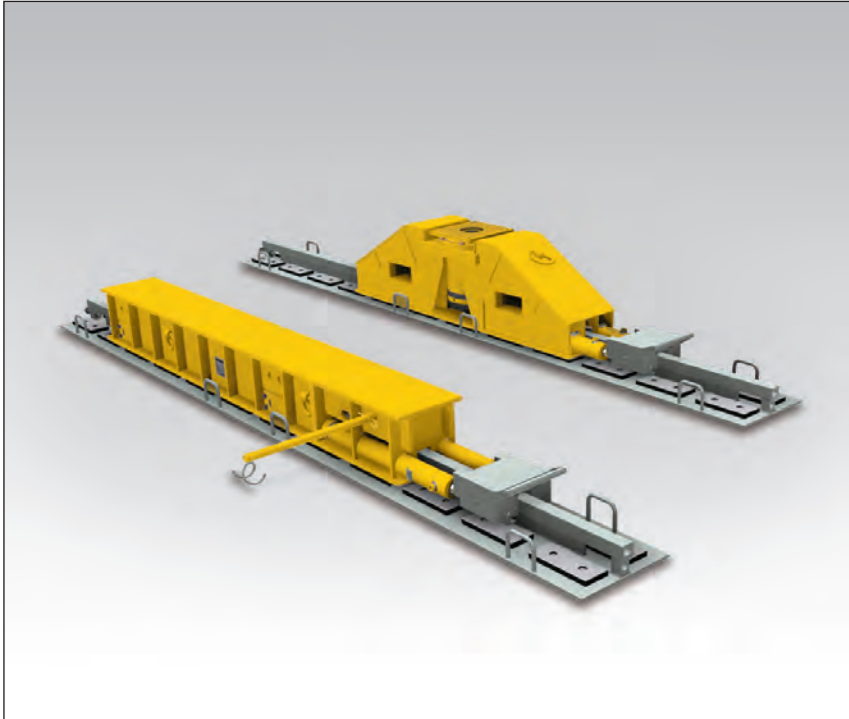

- PTFE skid pads with dimpled surface for low friction and long lifetime
- Easy to replace skid pads, no tools necessary
- Bi-directional operation using push/pull cylinders avoid the need to reposition cylinders for switching direction
- Large load support surface on the skid beams for distributing load
- Bottom of skid shoes equipped with stainless steel sliding plates
- Low-height versions available

▼ A custom hydraulic Low Height Skidding System (HSLH) will provide the maintenance team with the ability to maneuver and transport transformers with physical access limitations.



Ideal Jack and Slide Solution



Skidding Systems

The HSK skidding system is comprised of a series of skid shoes powered by hydraulic push-pull cylinders, travelling over a pre-constructed track.

A series of special PTFE coated blocks are placed on the skid-tracks. The PTFE surface is matched with a sliding plate under the Enerpac skid shoes, designed to achieve minimum friction coefficients. The skid shoes are connected by hoses to a hydraulic electric or diesel driven powerpack.

In addition to our standard skidding systems Enerpac can create customized skidding systems to meet your specific requirements.



Controls

Enerpac offers several options for controlling our skidding systems.

Wireless Controls allows the operator the freedom to view the skidding operation from multiple locations while providing complete control of all system functions.

Manual controls offer a cost-effective solution by utilizing manual hydraulic valves mounted directly on the skidding system power unit.

▼ HSKJ-1250 Skid Shoe Jack.





Skidding Systems

Enerpac Skidding Systems are available in several versions:

- **HSKB-Series (Skid Shoe Beam)** utilizes a tall skid shoe with built-in push/pull cylinders. Skidding direction can be easily switch by flipping a lever on the attached gripper box.
- **HSKJ-Series (Skid Shoe Jack)** provide the same functionality as the HSKB with the added benefit of having a built-in cylinder for lifting or leveling the load.

To calculate the minimum required capacity per shoe, the entire load has to be able to rest safely on 2 of the 4 shoes. To skid a load of 500 tons, the required skidding system is HSKB2500 or HSKJ2500.

HSK Series



Capacity:

140-280 tons

Stroke Push/Pull:

23.62 inches

Lifting Stroke*:

6.89 inches

* Skid shoe jack version only.

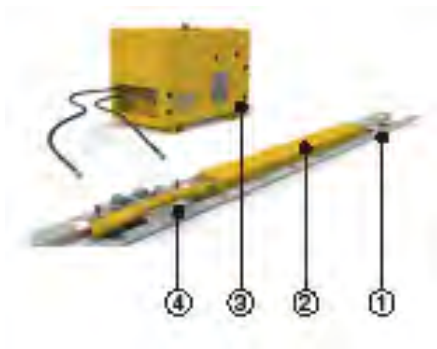

Skidding System Requirements

- ① Skid Track
- ② Skid Beam
- ③ Hydraulic Power Pack
- ④ Hydraulic Push/Pull Unit

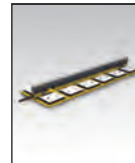

Skid Tracks

Include specially constructed and easily replaceable PTFE coated pads.



Hydraulic Power Packs

Enerpac offers a comprehensive range of hydraulic power packs that are optimized for use with their industry leading Skidding Systems.

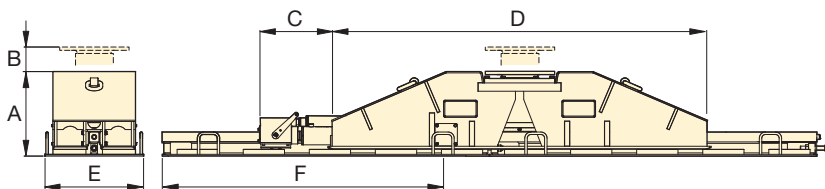

The Power Pack can operate up to 4 push/pull cylinders. Typically 4 skid shoes are used to skid a load. All details below are for the skid shoe and track. Skid track is sold separately.

Maximum Lifting Capacity (per shoe)	Maximum Skidding Capacity (ton)		Model Number	Skid Shoe Height (with track)	Lifting Stroke	Push/Pull Stroke	Skid Shoe Length	Skid Shoe Weight	Skid Track Width	Skid Track Length	Skid Track Weight
	Push	Pull									
(ton)				A (in)	B (in)	C (in)	D (in)	(lbs)	E (in)	F (in)	(lbs)
140	25	18	HSKB1250	12.17	–	23.62	98.43	1,631	15.75	78.07	265
140	25	18	HSKJ1250	19.76	6.89	23.62	66.54	1,742	15.75	78.07	265
225	29	16	HSKLH2000	8.03	–	23.62	114.25	750	21.26	78.66	220
280	45	30	HSKB2500	14.72	–	23.62	118.11	2,249	23.62	76.61	640
280	45	30	HSKJ2500	23.62	6.89	23.62	70.23	3,197	23.62	76.61	640

▼ Shown: HSL50006 Strand Jack



- Precision control of synchronous lifting and lowering
- Can be controlled by a single operator from a central location for increased safety
- Automated locking - unlocking operation
- Two strand sizes: 0.62 in (15.7 mm) and 0.71 in (18 mm)
- Telescopic strand guide pipes prevent bird caging
- Internal components are coated with Lunac, an anti-corrosion coating, making it suitable for marine environments
- Lifting anchor included with all strand jacks
- Lloyds witness tested to 125% of maximum working load

Heavy Lifting Strand Jacks

High Capacity - Precision Control



Strand Jacks

Enerpac strand jacks are the strand jacks of choice for customers seeking precise synchronous control with heavy lifting capacity in an economical, compact, and reliable foot print.

Enerpac strand jacks are powered by electrical or diesel driven hydraulic power packs and controlled by Enerpac's proprietary SCC-Smart Cylinder Control System to ensure full control of lifting and lowering operations.

Enerpac continually improves reliability, durability, and safety of their strand jacks, making them an industry standard for heavy lifting.

▼ Shown: HSL85007 Strand Jack System used on Enerpac custom Self-Erecting Tower.



▼ Enerpac's SCC-Smart Cylinder Control System simplifies synchronous operation with intuitive controls and a user-friendly graphical interface.



Heavy Lifting Strand Jacks



Strand Jacks

A strand jack can be considered a linear winch.

In a strand jack, a bundle of steel strands are guided through a main “lifting” jack. Above and below the cylinder are anchor systems with wedges that grip the strand bundle simultaneously. Lifting and lowering a load is achieved by hydraulically controlling the main jack and both mini jacks alternately.

In the case of system pressure loss, the wedges are mechanically closed automatically, holding the suspended load in place.

Today, strand jacks are widely recognized as the most sophisticated heavy lifting solution. They are used all over the world to erect bridges, load out offshore structures, and lift/lower heavy loads where the use of conventional cranes is neither economical nor practical.

HSL Series



Capacity:

17-1405 tons

Stroke:

9.8-23.6 inches

Maximum Operating Pressure:

5,000 psi

Shown: HSL20006 Strand Jack

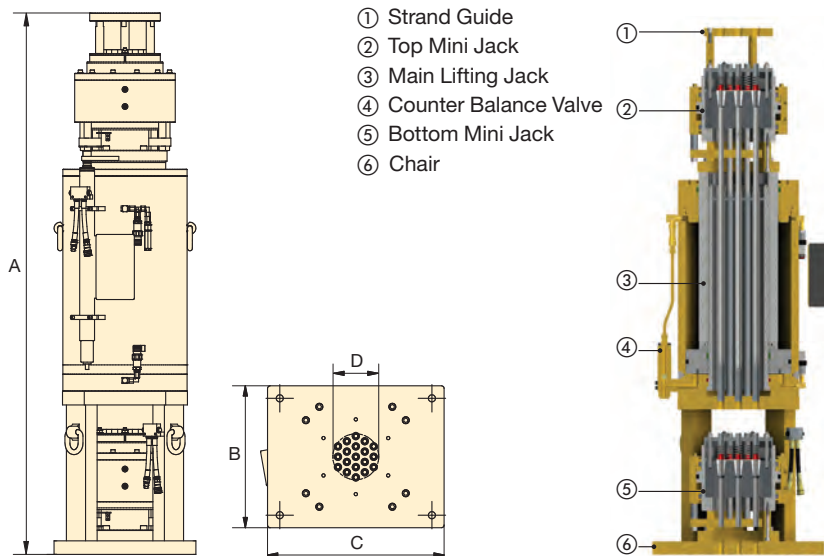

▼ **Strand Jack Accessories –**
 Contact Enerpac for assistance at enerpac.com/contact-us



SLPP-Series Hydraulic Power Packs

Enerpac offers a comprehensive range of hydraulic power packs that are optimized for use with their industry leading strand jacks.



SG-Series Strand Guide

Provides a guide for the strand as a strand jack lifts the load.



SR-Series Strand Recoiler

Passively pays in or pays out strands while jacking and lowering.

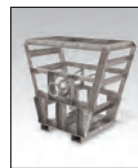

SD1 Strand Dispenser

Essential to safely unbundle a new strand coil.



Lifting Anchor

Each Strand Jack includes a lifting anchor for attaching strand to the load.

Strand Diameter inch (mm)	Capacity (tons)	Model Number	No. of Strands	Stroke (in)	A (in)	B (in)	C (in)	D (in)	Wt. (lbs)
0.62 (15.7)	34	HSL3006	3	18.9	72.9	13.8	19.7	2.3	1,102
	79	HSL7006	7	18.9	75.4	14.2	22.6	3.7	1,411
	225	HSL20006	19	18.9	78.4	20.6	25.6	6.7	2,860
	337	HSL30006	31	18.9	80.6	26.5	26.5	8.5	4,820
	562	HSL50006	48	18.9	84.1	28.9	28.9	10.7	6,930
0.71 (18)	17	HSL1507	1	9.8	48.9	8.7	8.7	0.8	220
	51	HSL4507	3	18.9	68.0	13.8	19.7	2.9	1,102
	67	HSL6007	4	18.9	69.0	15.7	24.6	3.5	1,433
	112	HSL10007	7	18.9	75.8	16.1	24.6	4.6	1,874
	225	HSL20007	12	18.9	78.8	20.6	25.6	6.5	3,086
	337	HSL30007	19	18.9	80.9	26.5	26.5	8.3	4,290
	506	HSL45007	31	18.9	87.5	28.9	28.9	10.7	6,724
	731	HSL65007	43	18.9	88.1	33.5	33.5	13.8	8,690
	955	HSL85007	55	18.9	94.6	35.4	35.4	14.3	11,023
	1124	HSL100007	66	18.9	100.7	43.0	43.0	17.2	16,865
1405	HSL125007	84	23.6	104.6	43.3	43.3	18.0	18,298	

▼ Shown: SBL1100 with STSBL Skid Tracks, Header Beams and Side Shifts



Precision Lift and Position of Heavy Loads

The Ultimate in Safety and Control



INTELLI-LIFT

The Intelli-Lift wireless control system is included with all Enerpac hydraulic gantries. The Intelli-Lift controller offers superior safety and control and includes the following features:

- Encrypted bi-directional communication that eliminates interference from other devices
- Remote operation using multi-channel wireless (2.4 GHz) or wired (RS-485) control
- High and low speed settings
- Automatic synchronization of lifting with an accuracy of 0.95 inch (24 mm)
- Automatic synchronization of travelling with an accuracy of 0.60 inch (15 mm)
- Overload and stroke alarms
- Remote side shift control
- Emergency stop switch

- Self-contained hydraulics and electronics
- Intelli-Lift wireless control system
- Self-propelled wheels or tank rollers
- Foldable boom on SBL900, SBL1100, MBL500 and MBL600
- Full range of supplementary equipment: header beams, lifting lugs, side shift, skid tracks
- Designed and tested to meet ASME B30.1-2015 safety standards
- Lloyds witness tested to 120% of maximum working load

▼ Shown: SBL1100



Maximum Capacity (4 legs) (tons)	Model No.	Retracted Height A (ft)
67	SL60	6.57
141	SL125	8.66
337	SL300	8.87
450	SL400	10.39
585	SBL500	9.93
1009	SBL900	16.42
1178	SBL1100	14.34
562	MBL500	20.01
674	MBL600	21.50

SL, SBL, MBL Series, Hydraulic Gantry



Hydraulic Gantries

Hydraulic Gantries are a safe, efficient way to lift and position heavy loads in applications where traditional cranes will not fit and permanent overhead structures for job cranes are not an option.

Hydraulic Gantries are placed on skid tracks to provide a means for moving and placing heavy loads, many times with only one pick.

Enerpac offers three series of Hydraulic Gantry systems:

- SL-Series Super Lift**
 The cost-effective SL-Series Super Lift offer control and stability for everyday lifting applications below 450 ton up to 25 feet.

- SBL-Series Super Boom Lift**
 The heavy-duty SBL-Series Super Boom Lift boom style gantries offer increased lifting capacity of over 450 ton to heights of almost 40 feet.
- MBL-Series Mega Boom Lift**
 The massive MBL-Series Mega Boom Lift offers capacities and lifting heights of over 600 ton to almost 47.7 feet extreme lifting conditions.

All Enerpac gantries are delivered with specific properties and control systems to ensure optimum stability and safety.

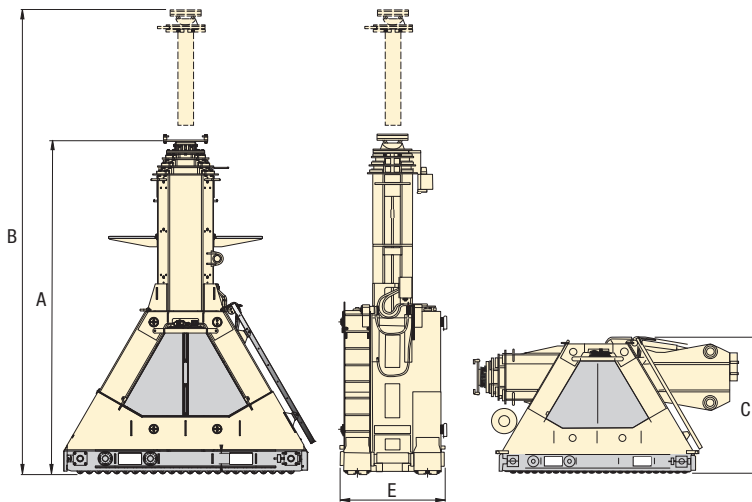

Drawing shows SBL-series, SL-series without boom.

Stage 1		Stage 2 ¹⁾		Stage 3		Transport Height	Base Width	Weight per Leg (with oil)	Model No. (4 towers)
Max. Height B (ft)	Max. Cap. (ton)	Max. Height B (ft)	Max. Cap. (ton)	Max. Height B (ft)	Max. Cap. (ton)				
11.17	17	15.43	17	–	–	–	31.50	2315	SL60
15.01	35	21.78	35	–	–	–	36.69	4696	SL125
15.11	84	21.98	56	–	–	8.87	34.65	7165	SL300
17.14	112	23.73	112	29.99	52	–	49.45	10,141	SL400
16.40	146	22.66	146	28.27	84	–	50.43	13,889	SBL500
27.24	252	37.07	166	–	–	7.36	55.43	29,432	SBL900
22.98	295	31.72	190	39.38	106	7.36	55.43	26,345	SBL1100
–	–	42.21	141	–	–	7.36	83.90	43,541	MBL500
–	–	47.74	169	–	–	8.28	95.71	46,187	MBL600

¹⁾ MBL500 and MBL600 are two stage gantries; stages 1 and 2 extend simultaneously and provide full capacity at any height.

²⁾ Weight per tower

SL, SBL, MBL Series



Capacity:

67-1178 tons

Lift Height:

15.43-47.74 feet

▼ Additional Accessories –

Contact Enerpac for assistance at enerpac.com/contact-us



Skid Tracks

Skid tracks used for leveling and load distribution. Available in two standard lengths, 10 feet and 20 feet.



Header Beams

Sold in pairs and includes lifting points and fork pockets for easy positioning on gantry towers.

Available in 26.24 ft., 32.80 ft. and 39.36 ft. lengths.



Powered Side Shift

Electric propulsion controlled by standard gantry controls. Each set consists of 4 units.



Lifting Anchors

Designed to transfer the load to the top of the header beam. Can accommodate a 250 ton shackle or attach directly to the lifted load.

▼ Shown: JS-250-Series Jack-Up System (one lifting tower shown)



Incremental Lifting System – Synchronously Lift and Mechanically Hold



Typical Applications

- Bridge construction and demolition
- Port crane lifting
- Shovel undocking
- Top side lifting
- Ship hull block installation



Computer Controls

Enerpac Jack-Up Systems provide precision control suitable for many demanding lifting and lowering applications. The comprehensive self-contained design features simple to use software.

- Computer control for operating the Jack-Up system with automatic and manual lifting settings
- Automatic synchronization of multiple networked lift points
- Center of Gravity calculation
- Overload and stroke alarms
- Emergency stop switch at jack-up units and controls

- Self-contained hydraulics in each jack-up unit for uncluttered work area
- Synchronously lift loads with multiple jack-up units. The most common system set-up includes four jack-up units but can be expanded to include more
- Lifting barrels are stacked together to mechanically hold the load
- Up to 5% side load capacity depending on capacity and lift height
- Computer controls for operating the Jack-Up System with automatic and manual lifting settings

▼ A load is lifted in increments as barrels are slid into the system, lifted, and stacked; forming 'lifting towers'.

▼ The steel barrels are stacked together to mechanically hold the load.

▼ Lifting an oil and gas pipe module



JS-Series, Jack-Up Systems



Enerpac Jack-Up Systems

The Jack-Up System is a custom developed multi-point lifting system. A typical system setup includes four jack-up units, one positioned under each corner of a load.

Example: A four unit setup with JS250 has a lifting capacity of 1000 ton (250 ton per unit). The lifting frame of a jack up unit contains four hydraulic lifting cylinders, one in each corner, which lift the load using the stacked steel barrels.

A load is lifted in increments as barrels are slid into the system, lifted, and stacked; forming 'lifting towers'. A jack up system is operated and controlled by a computer control unit.

Each unit's lifting and lowering operations occur simultaneously; the computer control unit's synchronous technology maintains the balance of the load.

JS Series



Capacity per Lifting Tower:

140-840 tons

Lifting Height:

Up to 20-66 feet

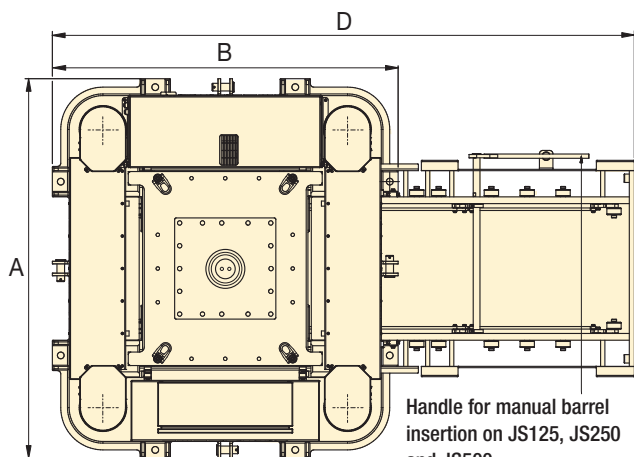

Handle for manual barrel insertion on JS125, JS250 and JS500. Automatic barrel insertion on JS750

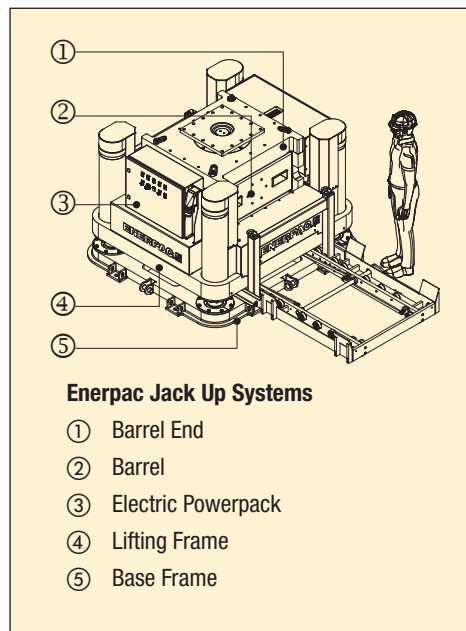
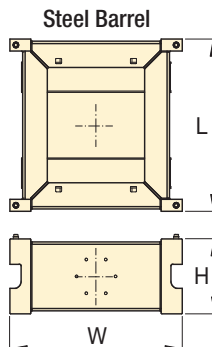
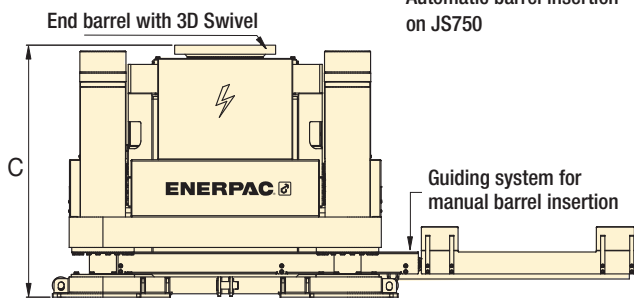

Enerpac Jack Up Systems

- ① Barrel End
- ② Barrel
- ③ Electric Powerpack
- ④ Lifting Frame
- ⑤ Base Frame



Contact Enerpac!

Contact the Enerpac office nearest to you for advice and technical assistance in the layout of your ideal solution or visit us on the web:
enerpac.com/contact-us.

▼ Bridge lifting with Enerpac Jack-Up System.



Cap. per Tower (ton)	Model Number	Maximum Sideload (ft)	Base Frame Dimensions (in)				Weight per Unit ** (lbs)	Barrel Dimensions (in)		
			A	B	C	D		L	W	H
140	JS-125	3% @ 19.6	47.24	43.31	37.40	29.53	4850	23.62	23.62	9.84
280	JS-250	3% @ 32.8	88.58	80.70	58.07	55.11	16535	45.27	45.27	19.69
560	JS-500	4% @ 49.2	110.23	90.55	66.92	86.61	28,660	66.93	66.93	27.56
840	JS-750	5% @ 65.6	144.48	127.95	93.50	112.20	52,911	90.55	90.55	39.37

* Lifting speed approximately 6 barrels per hour.

** Weight per jack-up unit, excluding end barrel or barrel sets.

▼ Shown: SPMT600-360



SPMT Series

Capacity (per transporter):

67 tons

Transport Speed (unloaded-loaded):

1.9 - 1.0 mph

Motor Size:

75 hp



Self-Propelled Modular Transporter

The Enerpac Self-Propelled Modular Transporter (SPMT) features a minimized height and slim design, which makes it very easy to operate in confined spaces. Each wheel unit has a steering function as well as a lifting cylinder at its disposal. Wheel propulsion is established by wheel drives.

The SPMT is operated by the Intelli-Drive Remote Controller. This remote controller can be used both hard wired and wireless (based on radio frequency).

The SPMT is a modular system comprised of trailers with 3 axle lines each and diesel hydraulic power units (HPU). Depending on the model number, the trailers and HPUs can be configured to a maximum of 4 trailers in 2 rows (4x2) or 6 trailers in 2 rows (6x2).

This is the maximum setup of units that can work together on just one Intelli-Drive Remote Controller.

- Modular design for multiple configurations
- Minimized height and slim design are ideal for in-plant operation
- Intelli-Drive wireless control system is intuitive and easy to use
- One power pack can operate 2-3 trailers maximum depending on model
- Two trailers and power pack can be shipped inside a 20 ft. container
- Hydraulic power unit is tier-4 diesel engine for reduced emissions

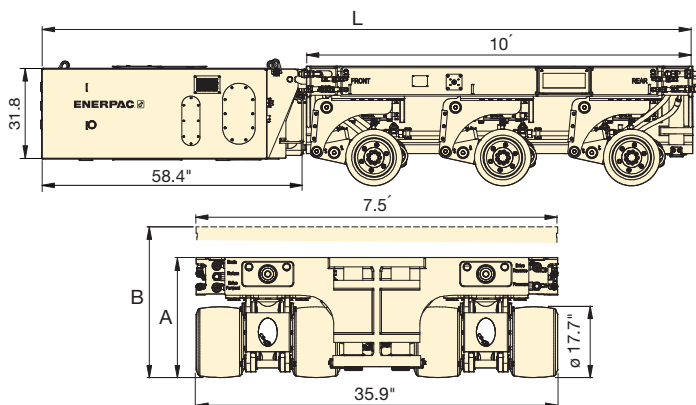

Capacity (per transporter) (ton)	Transporter Model Number	Maximum Configuration (transporters in rows)	Steering Range (degrees)	Steering Mode		Retracted Height A (in)	Average Travel Height B (in)		Overall Length L (ft)	Lifting Stroke (in)	Wt. (SPMT) (lbs)	HPU * Model No.	Wt. (HPU*) (lbs)
				crab	carousel								
67	SPMT600-100	4 x 2	±50°	•	–	30.20	37.76	14.96	15.12	15,432	MTPP-100	5512	
	SPMT600-360	6 x 2	±179°	•	•	30.07	37.64	17.02	15.12	17,637	MTPP-360	5512	

* HPU = 54 kW Power Pack Diesel. HPU is sold separately.

Custom Heavy Lifting Solutions

When your application requires something other than our standard product offering, look to Enerpac's Heavy Lifting Technology, experience, and expertise.

Our group of engineers, designers, and specialists will work with you to understand your specific application and provide a turn-key solution that will exceed your expectations.



STEEL FABRICATION

Enerpac has a dedicated facility for steel fabrication and welding. We design and manufacture custom structures used in demanding Heavy Lifting applications.



ENGINEERING

Enerpac's multi-disciplined Heavy Lifting Technology team is capable of the design and development of all aspects of an integrated system. Leveraging design and application experience with the latest in methodologies, computer design, rapid prototyping and analysis ensures delivery of the highest quality.



ELECTRONICS

Enerpac designs all control systems in-house. This capability keeps control technology close to the design engineers who are developing the rest of the system. In doing so, we can tailor the control system to match unique project requirements.



MACHINING

Enerpac utilizes the latest in CNC machining technologies and manufactures all large and special hydraulic cylinders in-house. We can machine diameters up to 3 inches with lengths to 25 inches.



FIELD SUPPORT

Enerpac's Heavy Lifting-Technology team is available to provide on-site support including training and troubleshooting of systems. Enerpac also stocks repair parts and consumable items at several locations to ensure fast delivery for minimal downtime.



HYDRAULIC POWER UNITS

Enerpac designs, assembles and tests small to large hydraulic power units in-house. Power units range from 0.5 to 300 hp and are tested with the system they are intended to operate.



MAINTENANCE and REPAIR

Due to the unique nature of Enerpac's Heavy-Lifting Technology systems, we offer complete maintenance and repair services. Our M&R group is available to assist customers who do not have access to local service facilities qualified to work on these systems.



JACK-UP SYSTEM

The Jack-Up system is a custom developed multipoint lifting system. A typical system setup includes four jack up units, one positioned under each corner of a load. A four unit setup has a lifting capacity of 2200 tons (567 tons per unit).



STRAND JACK GANTRY

The Strand Jack gantry is a steel structure to facilitate erection and skidding back, forth and sideways of heavy loads. The Enerpac strand jack gantry can be used with either skidding systems or hydraulic gantries on top.



AUTONOMOUS SYNCHRONOUS HOIST SYSTEMS

The SHAS-Series Synchronous Hoist System is a below-the-hook crane attachment comprised of multiple self-contained, PLC-controlled hydraulic lifting devices. The system enables a single crane to precisely position heavy and unbalanced loads.



BRIDGE LAUNCH

Providing a solution for the most complex and demanding bridge construction applications, Enerpac has over 20 years experience providing unique customer bridge launching systems.



TRAVEL GANTRY

The travel gantry combines the safety and efficiency of a hydraulic gantry with the ease of use of SPMT (Self-Propelled Modular Transporter) technology. With a lifting capacity of 67 tons, the travel gantry sets a new standard in equipment and container handling.



ROTOR REMOVAL AND INSTALLATION SYSTEM

The generator rotor removal and installation system is a custom developed product for removing and installing the rotor (field) in a power plant's generator. The system is designed to comply with the varying dimensions and challenging accessibility of a plant's generator.



CUSTOM HYDRAULIC PRESSES

Our hydraulic presses can be configured to fulfill a broad range of applications. Each press is designed and manufactured according to customer specifications and in cooperation with our engineering team.



SELF-ERECTING TOWER

The Enerpac Self-Erecting Tower (ESET) is a self-erecting tower lift system that enables you to build a free standing gantry from ground level. The ESET can be supplied in various capacities and lifting heights and is built with standard modular components, enabling a flexible solution to future project demands.



LAS VEGAS WHEEL

Our expertise has been acknowledged by the world's leading industrial professionals and has contributed to the successful movement of a number of the most recognizable structures on earth. At the time of construction, the Las Vegas High Roller was the largest observation wheel in the world. A custom hydraulic drive system was developed to propel the wheel for daily use and was also used to construct the wheel in sections.



Enerpac “Yellow Pages” stand for Hydraulic Information!

If selecting hydraulic equipment is not your daily routine then you will appreciate these pages. The “Yellow Pages” are designed to help you work with hydraulics. They will help you to better understand the basics of hydraulics, of system set-ups and of the most commonly used hydraulic techniques. The better your choice of equipment, the better you will appreciate hydraulics. Take the time to go through these “Yellow Pages” and you will benefit even more from Enerpac High Pressure Hydraulics.

Section		Page
Safety Instructions		274-275 ▶
Product Selection & Worksheet		276-277 ▶
Basic System Set-ups		278-279 ▶
Basic Hydraulics		280-281 ▶
Conversion Tables and Speed Charts		282-283 ▶
Valve Information		284 ▶
Hexagon Bolt and Nut Sizes		285 ▶
Torque Tightening Torque Tensioning		286-289 ▶



ENERPAC WARRANTY STATEMENT

www.enerpac.com

Visit our website for the complete Enerpac Global Warranty or call your Enerpac representative or Enerpac Authorized Service Center.

Enerpac is certified for several quality standards. These standards require compliance with standards for management, administration, product development and manufacturing.

CE Marking & Conformity

Enerpac provides Declarations of Conformity, Declarations of Incorporation, and CE marking for products that conform to the European Community Directives.



Enerpac works hard to maintain the ISO 9001 quality rating, in its ongoing pursuit of excellence.



Where specified, Enerpac electric power units meet the design, assembly and test requirements of The Standards Council of Canada (CAN C22.2 No. 68-92), and UL73 for the United States. Units were tested and certified for both USA and Canada by TUV, a nationally recognized testing laboratory.

EMC Directive

Where specified, Enerpac electric power pumps meet the requirements for Electro-magnetic Compatibility per EMC Directive 2004/108/EC.



ATP-1500, ZA and XA-Series air-motor driven pumps, and S- and W-Series Torque Wrenches are tested and certified according to the Directive 2014 / 34 / EU “ATEX Directive”. The explosion protection is for equipment group II, equipment category 2 (hazardous area zone 1), in gas and/or dust atmospheres. ATP-1500, ZA and XA-Series pumps are marked with: Ex II 2 GD ck T4.

ASME B30.1-2015

Our cylinders fully comply with the criteria set forth by the American Society of Mechanical Engineers (except RD, BRD, CLL, CLS and CLP-Series).

ISO1402, ISO4672, ISO6803

Enerpac thermoplastic hoses are related to the criteria set forth in these standards.

Product Design Criteria

All hydraulic components are designed and tested to be safe for use at maximum 10,000 psi unless otherwise specifically noted.



- Lift slowly and check often
- Avoid standing in the line of force
- Anticipate possible problems and take steps to avoid them

When used correctly, hydraulic power is one of the safest methods of applying force to your work. To that end we offer some DO's and DON'Ts, simple common sense points which apply to practically all Enerpac hydraulic products.

The illustrations and application photos of Enerpac products throughout this catalog are used to portray how some of our customers

have used hydraulics in industry. In designing similar systems, care must be taken to select the proper components that provide safe operation and fit your needs. Check to see if all safety measures have been taken to avoid the risk of injury and property damage from your application or system. Enerpac cannot be held responsible for damage or injury caused by unsafe use, maintenance or application of its products.

Please contact the Enerpac office or a representative for guidance when you are in doubt as to the proper safety precautions to be taken in designing and setting up your particular system.

In addition to these tips, every Enerpac product comes with specific safety information and instructions. Please read them carefully.

Jacks

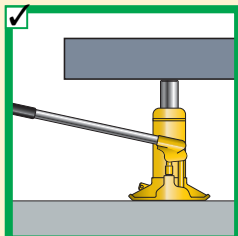
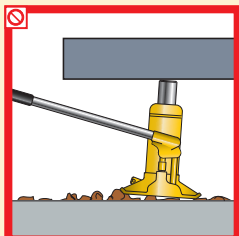

◀ Provide a level and solid support for the entire jack base area.

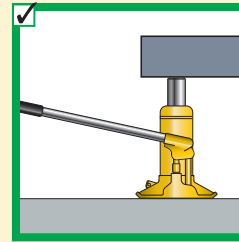
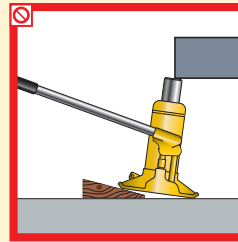

◀ The entire jack saddle must be in contact with the load. Movement of the load must be in the same direction as jack plunger.



◀ Never place any part of your body under the load. Ensure the load is on a solid support before venturing under.

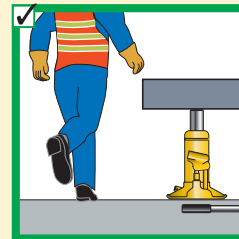
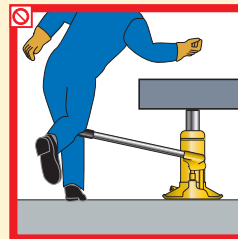

◀ Remove the jack handle when it is not being used.

Cylinders

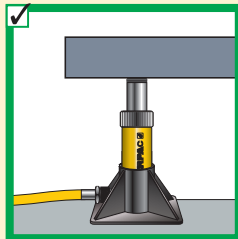
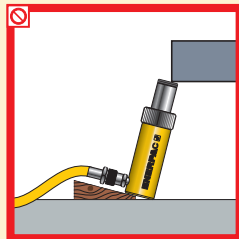

◀ Provide a solid support for the entire cylinder base area. Use cylinder base attachment for more stability.

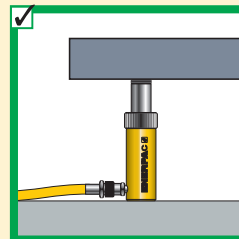
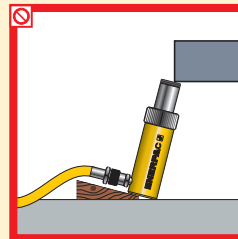

◀ The entire cylinder saddle must be in contact with the load. Movement of the cylinder must be parallel with the movement of the load.

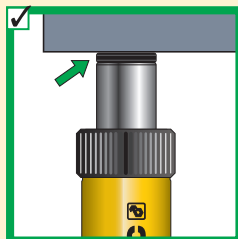
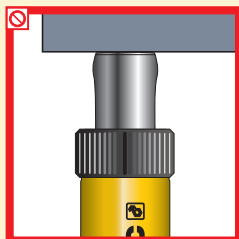

◀ Do not use cylinder without saddle. This will cause plunger to "mushroom". Saddles distribute load evenly on the plunger.



◀ As with jacks, never place any part of your body under the load. Load must be on cribbing before venturing under.



◀ Always protect cylinder threads for use with attachments.

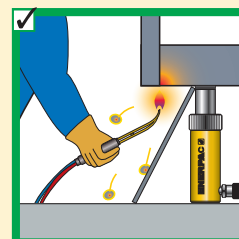

◀ Keep hydraulic equipment away from open fire and temperatures above 150 °F (65 °C).



General

80% Manufacturer's rating of load and stroke are maximum safe limits. **80%** Good practice encourages using only 80% of these ratings!

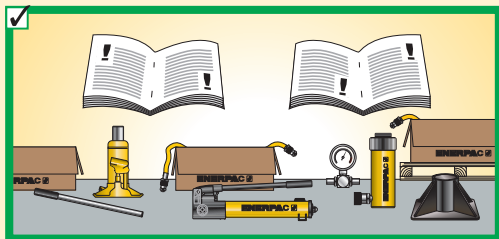

Always read instructions and safety warnings that come with your Enerpac hydraulic equipment.

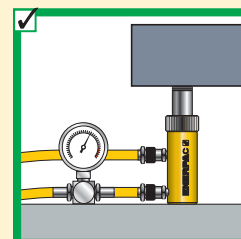
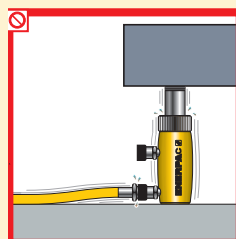

Both couplers must be connected when using double-acting cylinders. Ensure return hose is fitted.

Pumps

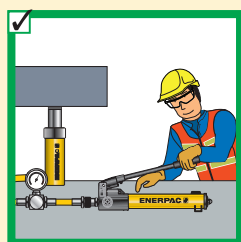
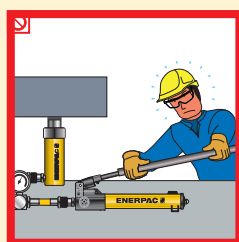

Don't use handle extenders. Hand pumps should be easy to operate when used correctly.

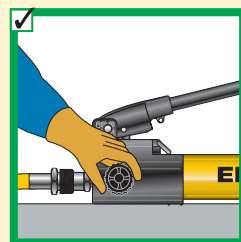
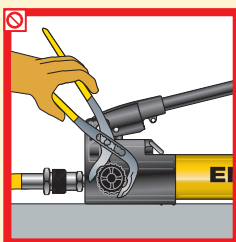

Close release valve finger tight. Using force will ruin the valve.

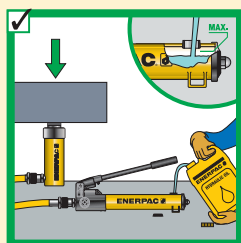
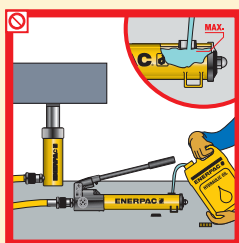

Fill pump only to recommended level. Fill only when connected cylinder is fully retracted.

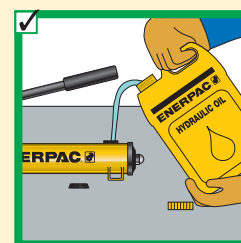
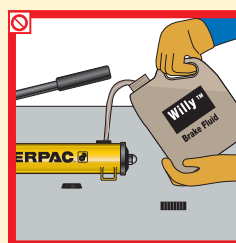

Always use genuine Enerpac hydraulic oil.

Hoses and couplers

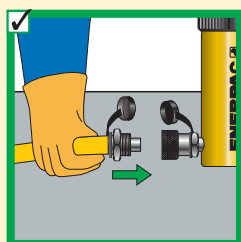
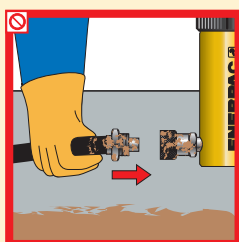

Clean both coupler parts before connecting. Use dust caps when coupler parts are not connected.

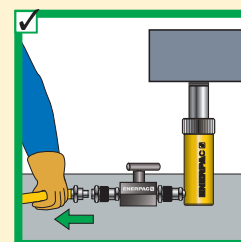
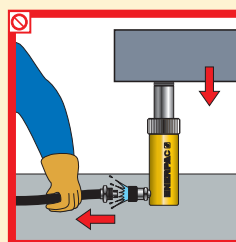

Detach cylinder only when fully retracted or use shut-off valves or safety valves to lock-in cylinder pressure.

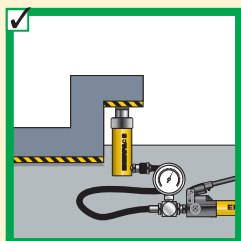
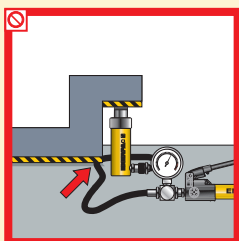

Keep hoses away from the area beneath loads.

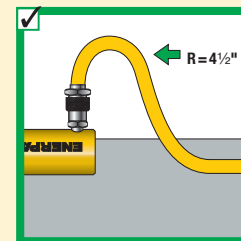
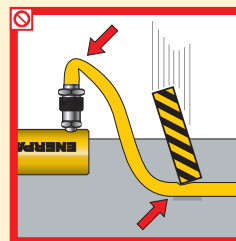

Don't kink hoses. Bending radius should be at least 4 1/2 inch. Don't drive over or drop heavy objects on hoses.

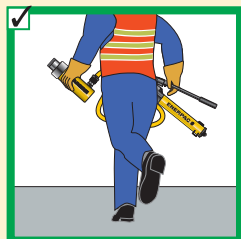



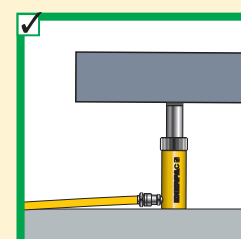
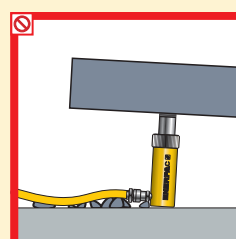

Don't lift hydraulic equipment by the hoses.



Never allow the cylinder to be lifted off of the ground through the couplers.









▼ HAND PUMP AND SINGLE-ACTING CYLINDER MATCHING CHART

Capacity (tons) ▶ ▼ Stroke (inches)	5 t	10 t	15 t	25 t	30 t	50 t	60 t	75 t	100 t	150 t
< 1.00										
1.00										
2.00										
3.00										
4.00										
5.00										
6.00										
7.00										
8.00										
9.00										
10.00										
12.00										
13.00										
14.00										
		P-392			P-80		P-462			
		Page: 70			Page: 72		Page: 72			

Note: Selection based on oil capacity requirements of cylinders.

▼ POWER PUMP SELECTION CHART

Oil Flow*	Low (20 in ³ /min)		Medium (60 to 100 in ³ /min)		High (33 to 305 in ³ /min)	
Reservoir Oil Capacity	0.5-1 gal.	1.5 gal.	1.0-10 gal.	1.0-10 gal.	2.5-10 gal.	10-40 gal.
Duty Cycle**	Intermittent	Extended	Intermittent	Extended	Extended	Extended
Portable/Stationary***	Portable	Stationary	Portable	Stationary	Stationary	Stationary
Recommended Series	PU-Series Economy	PE-Series Submerged	ZU4-Series	ZE3-5 Series	ZE6 Series	SFP Series
						
	Page: 82	Page: 84	Page: 90	Page: 96	Page: 96	Page: 118

* Oil Flow

- Determined by motor size
- Directly affects electrical power requirements
- Determines cylinder or tool speed

** Duty Cycle

- Extended applications require more than one hour of uninterrupted pump use
- Intermittent use – from 20 minutes to one hour, depending on reservoir capacity (contact Enerpac for details)

*** Portability

- | | |
|-------------------------------|----------------------------------|
| Portable | Stationary |
| • Ergonomic handles | • Mounting options |
| • Flexible power requirements | • Normally requires stable power |

Product Selection Worksheet



▼ Complete the following information to select the right products:

Cylinder Selection	Question:	Tips/help	Data	Model Number
	Total force required in tons:	Total load		
	Number of cylinders required:	Number of lifting points		
	Force per cylinder in tons:	Should be 80% of total cylinder cap.		
	Stroke required:	Plunger travel		
	Single or double acting (D/A):	D/A used when pull force is required, or retract speed is critical		
	Type of plunger required:	Hollow or solid		
	Collapsed height required:	Height with plunger fully retracted		
	Optional saddle required:	Tilt, Grooved, Flat		
	Cylinder base:	Improves stability		
	Cylinder attachments: (RC-series)	Expanded functions		
Selected cylinder model:			▶	
Including coupler model:				

Pump Selection

The three most commonly selected pumps are hand pumps, electric pumps and air-driven pumps. Gas powered pumps, however can be selected in the same way.

Available power source: Manual Battery Electric Compressed Air Gasoline

Hand pump _____ Not for high-cycle applications
 Single- or double-acting operation Use 4-way valve for D/A applications
 Check speed chart on page 283 for number of strokes per inch

Selected hand pump: ▶

Electric or compressed air pump _____
 Need for portability: Weight and power requirements
 Duty cycle: Intermittent or extended
 Required usable oil capacity: Intermittent = 1.2 x cylinder oil capacity
 high cycle = 2 x cylinder oil capacity
 Available voltage: Single phase or Three phase
 Lifting speed (Important/not important): Use speed chart on page 283
 Type of control: Manual/remote pendant
 Type of actuation/function: Advance/hold/retract
 Accessories: Roll bar, Oil Filter kit, ...

Selected pump: ▶

To suit hose: Oil connection

System Components

Number of hoses and length required: _____

Selected hoses: ▶

Manifold or tee: ▶
 Extra hose per manifold (2): ▶
 Gauge (psi, lbs or tons scale): GF-series glycerine for high cycle ▶
 Gauge adaptor: ▶
 Fittings: ▶
 Pressure relief safety valve: ▶
 Load-holding valve(s): ▶
 Hydraulic oil: ▶



- 1 Cylinder**
Applies hydraulic force.
Page 5
- 2 Cylinder Base Plate**
For applications such as lifting where additional cylinder stability is required.
Page 10
- 3 Pump**
Provides hydraulic flow.
Page 68
- 4 Hose**
Transports hydraulic fluid.
Page 132-133
- 5 Male Coupler**
For quick connection of the hose to system components.
Page 134-135
- 6 Female Coupler**
For quick connection of the hose end to the system components.
Page 134-135
- 7 Gauge**
To monitor pressure of the hydraulic circuit.
Page 138-139
- 8 Gauge Adaptor**
For quick and easy gauge installation.
Page 144
- 9 Swivel Connector**
Allows proper alignment of valves and/or gauges. Used when units being connected cannot be rotated.
Page 145
- 10 Auto-damper Valve V-10**
Used to protect gauge from damage due to sudden pulses in the system. Needs no adjustment and allows correct positioning of gauge, prior to tightening.
Page 146-147

Single-acting push application, such as in a press.

The hand pump offers controlled cylinder advance, but may require many hand pump strokes in longer stroke applications when the cylinder capacity is 25 ton or above.

Examples of pump, hose and cylinder sets can be found on page 52.

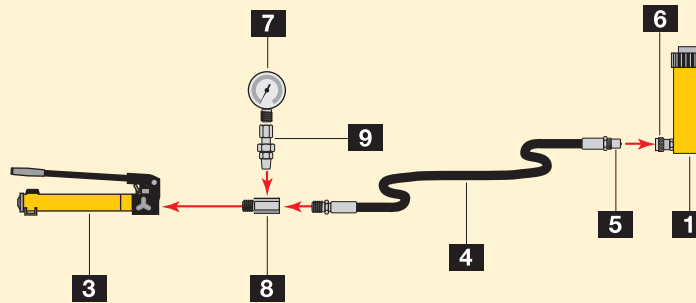

Single-acting cylinder with longer stroke used for lifting applications.

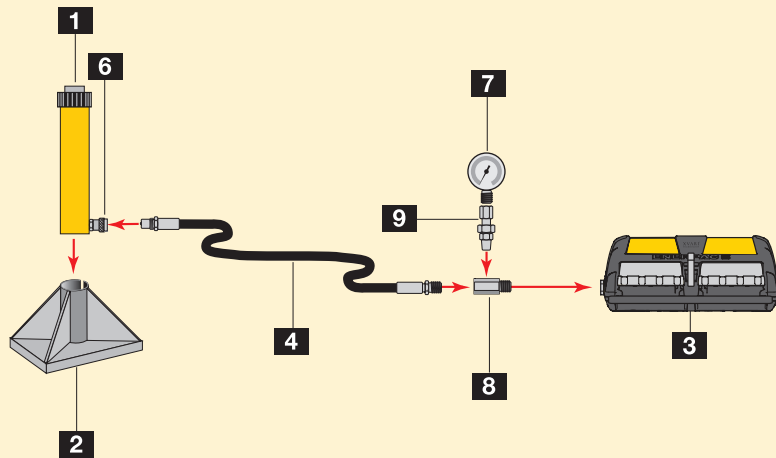

Double-acting cylinder set-up used for lifting applications where a slow controlled descent of the load must be maintained.

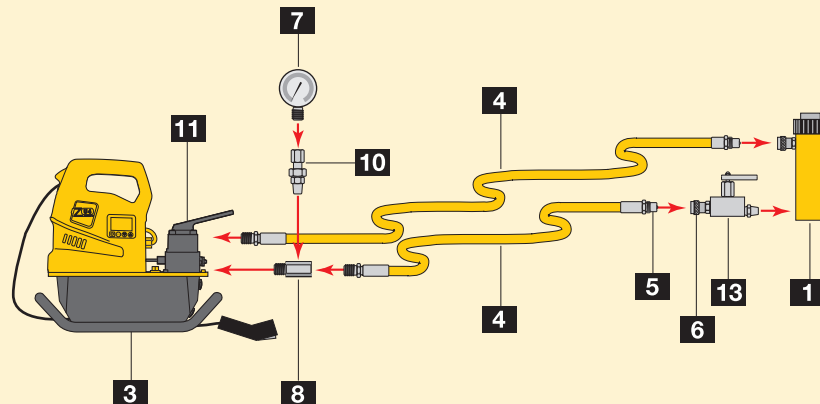



Double-acting cylinder set-up used in a push/pull application.

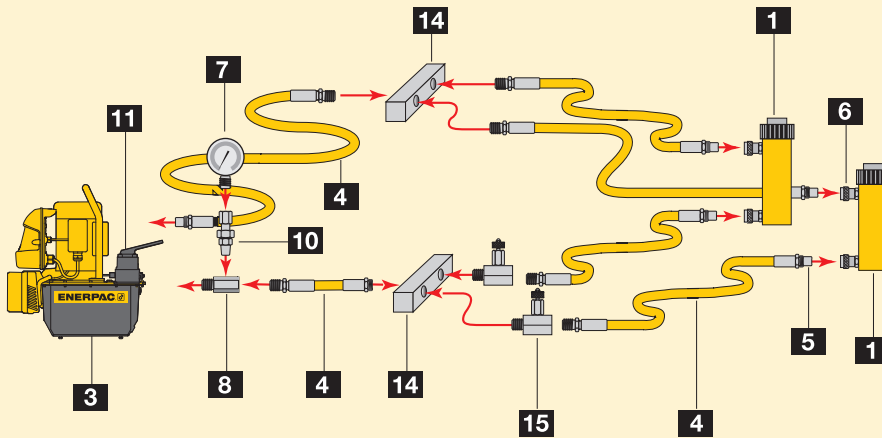

11 4-Way Directional Control Valve
Controls the direction of hydraulic fluid in a double-acting system.
Page 146-147

12 3-Way Directional Control Valve
Controls the direction of hydraulic fluid in a single-acting system.
Page 146-147

13 Safety Holding Valve
Controls load descent in lifting applications.
Page 147

14 Manifold
Allows distribution of hydraulic fluid from one power source to several cylinders
Page 136

15 Needle Valve
Regulates the flow of hydraulic fluid to or from the cylinders.
Page 147

Two point lifting set-up using single-acting cylinders.

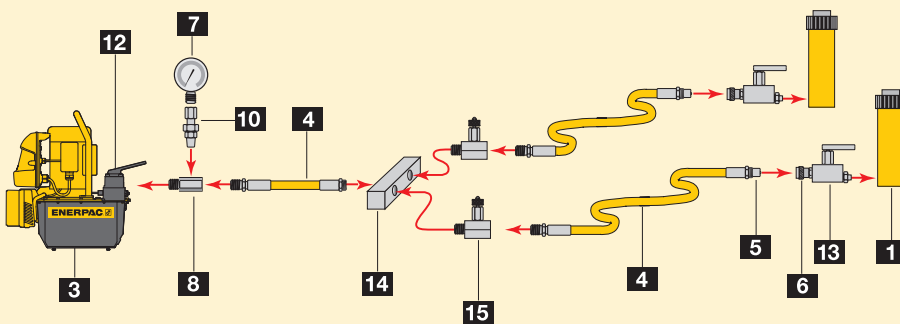

www.enerpac.com
Visit our web site to learn more about hydraulics and system set-ups.

Four point lifting set-up, using single-acting cylinders, flow control valves and safety valves.

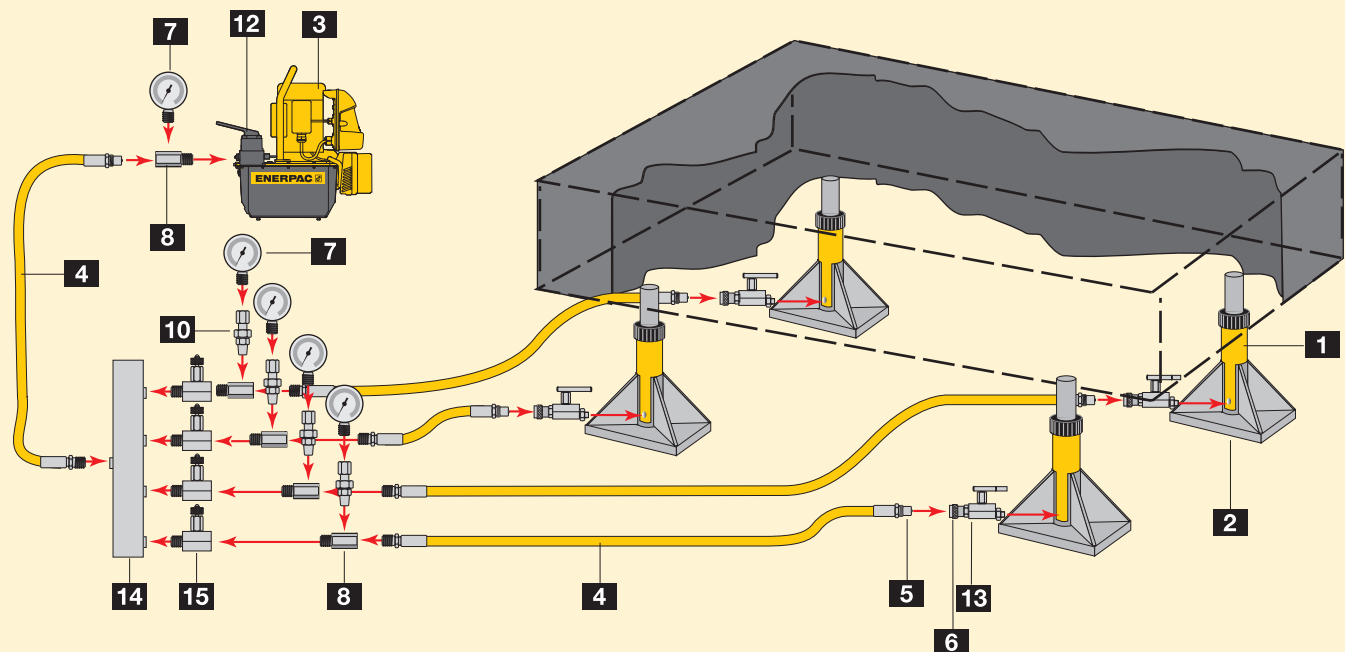



Flow

A hydraulic pump produces flow

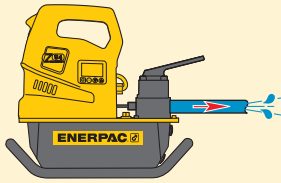

Pressure

Pressure occurs when there is resistance to flow

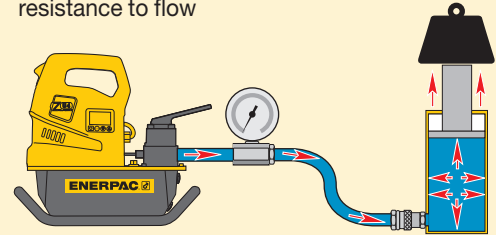

Pascal's Law

Pressure applied at any point upon a confined liquid is transmitted undiminished in all directions (Fig.1).

This means that when more than one hydraulic cylinder is being used, each cylinder will lift at its own rate, depending on the force required to move the load at that point (Fig. 2).

Cylinders with the lightest load will move first, and cylinders with the heaviest load will move last (Load A), as long as the cylinders have the same capacity.

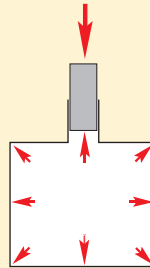

Figure 1

To have all cylinders operate uniformly so that the load is being lifted at the same rate at each point, either control valves (see Valve section) or Synchronous Lift System components (see Cylinder section) must be added to the system (Load B).

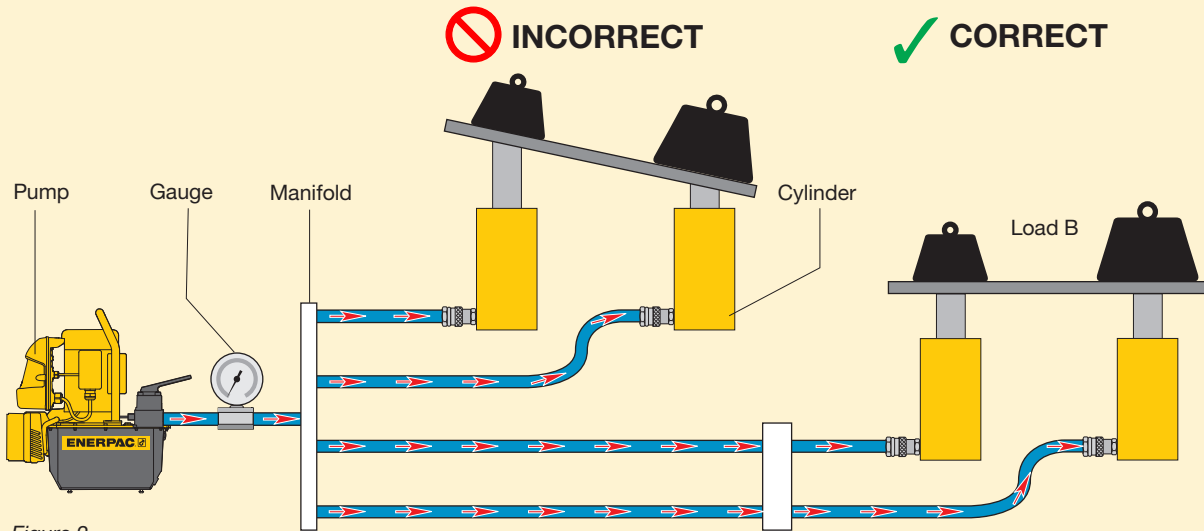

Figure 2

Synchronous Lift or Control Valves to provide uniform lifting of load.



CAUTION!

When lifting or pressing, always use a gauge.

A gauge is your "window" to the system. It lets you see what's going on. You will find the gauges in the System Components section.



Learn more about hydraulics

Visit www.enerpac.com to learn more about hydraulics and system set-ups.



Force

The amount of force a hydraulic cylinder can generate is equal to the hydraulic pressure times the “effective area” of the cylinder (see cylinder selection charts).

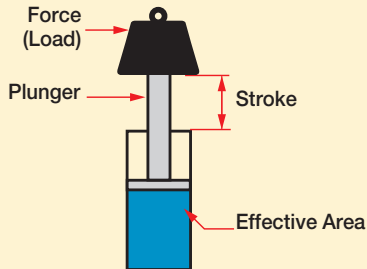

Force	=	Hydraulic Working Pressure	x	Cylinder Effective Area
-------	---	----------------------------	---	-------------------------

F	=	P	x	A
---	---	---	---	---

Use this formula to determine either force, pressure or effective area if two of the variables are known.

Example 1

An RC-106 cylinder with 2.24 in² effective area operating at 8,000 psi will generate what force?

Force = 8,000 psi x 2.24 in² = 17,920 lbs.

Example 2

An RC-106 cylinder lifting 14,000 lbs will require what pressure?

Pressure = 14,000 lbs ÷ 2.24 in² = 6,250 psi.

Example 3

An RC-256 cylinder with 5.15 in² effective area is required to produce a force of 41,000 lbs. What pressure is required?

Pressure = 41,000 lbs. ÷ 5.15 in² = 7961 psi.

Example 4

Four RC-308 cylinders each with 6.49 in² effective area are required to produce a force of 180,000 lbs. What pressure is required?

Pressure = 180,000 lbs ÷ (4 x 6.49 in²) = 6933 psi.

Remember, since four cylinders are used together, the area for one cylinder must be multiplied by the number of cylinders used.

Example 5

A CLL-2506 cylinder with 56.79 in² effective area is going to be used with a power source that is capable of 7,500 psi. What is the theoretical force available from that cylinder?

Force = 7,500 psi x 56.79 in² = 425,925 lbs.

Cylinder Oil Capacity

The volume of oil required for a cylinder (cylinder oil capacity) is equal to the effective area of the cylinder times the stroke*.

Example 1

An RC-158 cylinder with 3.14 in² effective area and an 8 in. stroke will require what volume of oil?

Oil Capacity = 3.14 in² x 8 in = 25.12 in³

Example 2

An RC-5013 cylinder has an effective area of 11.05 in² and a stroke of 13.25 in. How much oil will be required?

Oil Capacity = 11.05 in² x 13.25 in = 146.41 in³

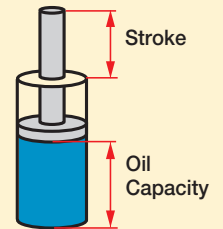

Cylinder Oil Capacity	=	Cylinder Effective Area	x	Cylinder Stroke
-----------------------	---	-------------------------	---	-----------------

* **Note:** these are theoretical examples and do not take into account the compressibility of oil under high pressure.

Example 3

An RC-10010 cylinder has an effective area of 20.63 in² and a stroke of 10.25 in. How much oil will it require?

Oil Capacity = 20.63 in² x 10.25 in = 211.46 in³

Example 4

Four RC-308 cylinders are being used, each with an effective area of 6.49 in² and stroke of 8.25 in. How much oil will be required?

Oil Capacity = 6.49 in² x 8.25 in = 53.54 in³ for one cylinder

Multiply by four to obtain the required capacity: 214.17 in³



CAUTION!

Enerpac oil will compress 2.28% at 5,000 psi and 4.1% at 10,000 psi.

Page: 136



Key to cylinder dimensions

Dimensions shown in the Selection Charts of the cylinder section are identified on the relevant drawings by the capital letter references listed here: A for collapsed height through Z for depth of internal base thread.

- A = Collapsed height
- B = Extended height
- C = Cylinder body length
- D = Cylinder outside diameter
- D1 = Cylinder width
- E = Cylinder inside diameter (bore)
- F = Plunger rod diameter
- G = Oil inlet thread
- H = Cylinder bottom to advance port
- I = Cylinder top to retract port
- J = Saddle outside diameter
- K = Cylinder rod protrusion at collapsed height
- L = Plunger center to side of base
- M = Mounting holes to plunger center
- N = Length of smaller cylinder part
- O = Plunger hole or thread of saddle
- P = Plunger thread length
- Q = Plunger outside thread (pull cylinders only)
- U = Bolt circle diameter of mounting holes
- V = Thread of cylinder mounting holes
- W = Collar thread
- X = Collar thread length
- Y = Center hole diameter (hollow cylinders only)
- Z = Depth of internal base thread

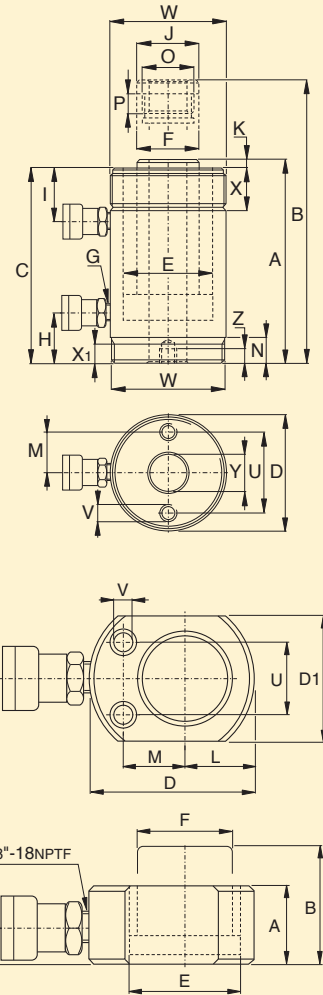

Key to measurements

All capacities and measurements in the catalog are expressed in uniform values.

The conversion chart provides helpful information for their translation into equivalent systems.

You can also visit our website at www.enerpac.com to download a FREE conversion calculator.

Pressure:

- 1 psi = .069 bar
- 1 bar = 14.50 psi
- 1 kPa = .145 psi

Volume:

- 1 in³ = 16.387 cm³
- 1 cm³ = .061 in³
- 1 liter = 61.02 in³
- 1 liter = .264 gal
- 1 US gal = 3,785 cm³
- = 3.785 l
- = 231 in³

Weight:

- 1 pound (lb) = .4536 kg
- 1 kg = 2.205 lbs
- 1 metric ton = 2,205 lbs
- 1 ton (short) = 2,000 lbs
- 1 ton (short) = 907.18 kg

Temperature:

- To convert °F to °C:
 $T_{°C} = (T_{°F} - 32) \div 1.8$
- To convert °C to °F:
 $T^{°F} = (T_{°C} \times 1.8) + 32$

Torque:

- 1 Ft.lbs = 1.356 Nm
- = 0.138 kgf.m
- 1 Nm = .738 Ft.lbs
- = 0.102 kgf.m

Other measurements:

- 1 in = 25.4 mm
- 1 mm = .039 in
- 1 in² = 6.452 cm²
- 1 cm² = .155 in²
- 1 hp = .735 kW
- 1 kW = 1.359 hp
- 1 Nm = .73756 Ft.lbs
- 1 Ft.lbs = 1.355818 Nm

Imperial to metric

Inches	Decimal	mm
1/16	.06	1.59
1/8	.13	3.18
3/16	.19	4.76
1/4	.25	6.35
5/16	.31	7.94
3/8	.38	9.53
7/16	.44	11.11
1/2	.50	12.70
9/16	.56	14.29
5/8	.63	15.88
11/16	.69	17.46
3/4	.75	19.05
13/16	.81	20.64
7/8	.88	22.23
15/16	.94	23.81
1	1.00	25.40



Cylinder Speed

This chart will help you calculate the time required for an Enerpac cylinder to lift a load when powered by a 10,000 psi Enerpac hydraulic pump.

The Cylinder Speed Chart can also be used to determine the pump type and model best suited for an application when you know the plunger speed required.

To determine:

Cylinder plunger speed

An RC-308 cylinder (30 ton) is powered by a ZE-5 pump. While lifting the load, the cylinder plunger will require 3.2 seconds to travel 1 inch. While extending towards the load, the cylinder

plunger travels at .46 sec/in.

5 t	30 t	50 t	75 t	100 t					
No Load	No Load	No Load	No Load	No Load	Pump Type				
20.6	3.2	5.5	44.2	8.0	63.6	10.3	82.5	XC Series*	
15.5	1.9	3.3	33.2	4.8	47.7	6.2	61.9	PU Economy	
5.2	5.6	4.6	98	11.3	1.4	15.9	1.8	20.7	ZU4 Series
15.5	2.6	4.4	33.2	6.4	47.7	8.3	61.9	PE Submerged	
7.7	.87	1.5	16.6	2.1	23.9	2.8	30.9	ZE3 Series	
5.2	.60	1.0	11.1	1.5	15.9	1.9	20.6	ZE4 Series	
2.6	.46	3.2	46.6	1.1	6.9	1.5	10.9	ZE5 Series	
1.5	.43	1.9	.74	3.3	1.1	4.8	1.4	6.2	ZE6 Series
6.7	.38	.84	86	1.4	94	2.1	1.2	2.7	8000-Series
20.6	3.2	5.5	44.2	8.0	63.6	10.3	82.5	XA Series	
30.9	6.5	39.0	110	66.3	15.9	95.5	20.6	123.9	Turbo II Pump
38.6	7.8	48.7	133	82.9	19.1	119.3	24.8	154.7	PA-133

To determine:

Best matching pump

Your 30 ton cylinder needs to move a load at a speed of 6.50 sec/in. Simply go down from the top of the chart, to the value of 6.50 sec/in. Then follow the chart to the right to find that the ZE4

pump or ZU4 is most suitable for your application.

30 t	50 t	75 t	100 t						
No Load	No Load	No Load	No Load	Pump Type					
16	3.2	5.5	44.2	8.0	63.6	10.3	82.5	XC Series*	
5	1.9	3.3	33.2	4.8	47.7	6.2	61.9	PU Economy	
2	5.6	4.6	98	11.3	1.4	15.9	1.8	20.7	ZU4 Series
5	2.6	4.4	33.2	6.4	47.7	8.3	61.9	PE Submerged	
7	.87	1.5	16.6	2.1	23.9	2.8	30.9	ZE3 Series	
2	.60	1.0	11.1	1.5	15.9	1.9	20.6	ZE4 Series	
6	.46	3.2	46.6	1.1	6.9	1.5	10.9	ZE5 Series	
5	.43	1.9	.74	3.3	1.1	4.8	1.4	6.2	ZE6 Series
7	.38	.84	86	1.4	94	2.1	1.2	2.7	8000-Series
16	3.2	5.5	44.2	8.0	63.6	10.3	82.5	XA Series	
19	6.5	39.0	110	66.3	15.9	95.5	20.6	123.9	Turbo II Pump
16	7.8	48.7	133	82.9	19.1	119.3	24.8	154.7	PA-133

Number of Pump Handle Strokes per Inch of Cylinder Plunger Travel

Cyl. Capacity ▶	5 ton		10 ton		15 ton		25 ton		30 ton		50 ton		75 ton		100 ton		Pump Type	Page
	No Load	Load	No Load	Load	No Load	Load	No Load	Load	No Load	Load	No Load	Load	No Load	Load	No Load	Load		
▼ Power Source Manual	18.0	18.0	40.7	40.7	57.1	57.1	93.8	93.8	118.0	118.0	200.7	200.7	289.1	289.1	375.1	375.1	P-141	71
	6.6	6.6	14.9	14.9	20.9	20.9	34.4	34.4	43.3	43.3	73.6	73.6	106.0	106.0	137.5	137.5	P-39	73
	6.6	6.6	14.8	14.8	20.8	20.8	34.2	34.2	43.0	43.0	73.1	73.1	105.3	105.3	136.6	136.6	P-391	71
	4.5	18.0	10.1	40.7	14.2	57.1	23.3	93.8	29.4	118.0	50.0	200.7	71.9	289.1	93.3	375.1	P-142/202	71
	1.4	6.6	3.3	14.8	4.6	20.8	7.5	34.2	9.4	43.0	16.1	73.1	23.1	105.3	30.0	136.6	P-392	71
	1.0	6.6	2.2	14.9	3.1	20.9	5.2	34.4	6.5	43.3	11.0	73.6	15.9	106.0	20.6	137.5	P-77/80/84/801	73
	0.4	6.6	0.9	14.8	1.3	20.8	2.2	34.2	2.7	43.0	4.6	73.1	6.6	105.3	8.6	136.6	P-802/842	71
	0.1	3.4	0.3	7.7	0.4	10.8	0.7	17.8	0.8	22.4	1.4	38.1	2.1	54.8	2.7	71.1	P-462/464	73

Seconds per Inch of Cylinder Plunger Travel

Cyl. Capacity ▶	5 ton		10 ton		15 ton		25 ton		30 ton		50 ton		75 ton		100 ton		Pump Type	Page	
	No Load	Load	No Load	Load	No Load	Load	No Load	Load	No Load	Load	No Load	Load	No Load	Load	No Load	Load			
▼ Power Source Electric (speed based on 60 Hz)	.05	4.0	1.1	9.0	1.6	12.6	2.6	20.6	3.2	26.0	5.5	44.2	8.0	63.6	10.3	82.5	XC Series*	80	
	.30	3.0	.67	6.7	.94	9.4	1.5	15.5	1.9	19.5	3.3	33.2	4.8	47.7	6.2	61.9	PU Economy	82	
	.08	1.0	.19	2.2	.27	3.1	.44	5.2	5.6	6.5	.95	11.1	1.4	15.9	1.8	20.7	ZU4 Series	90	
	.40	3.0	.90	6.7	1.3	9.4	2.1	15.5	2.6	19.5	4.4	33.2	6.4	47.7	8.3	61.9	PE Submerged	102	
	* XC based on 28V battery	.13	1.5	.30	3.4	.42	4.7	.69	7.7	.87	9.7	1.5	16.6	2.1	23.9	2.8	30.9	ZE3 Series	96
	.09	1.0	.21	2.2	.29	3.1	.48	5.2	.60	6.5	1.0	11.1	1.5	15.9	1.9	20.6	ZE4 Series	96	
	.07	.50	.16	1.12	.22	1.6	.36	2.6	.46	3.2	.78	5.5	1.1	8.0	1.5	10.3	ZE5 Series	96	
	.07	.30	.15	.67	.21	.94	.34	1.5	.43	1.9	.74	3.3	1.1	4.8	1.4	6.2	ZE6 Series	96	
	.06	.13	.13	.29	.19	.41	.30	.67	.38	.84	.65	1.4	.94	2.1	1.2	2.7	8000-Series, PE	102	
Air (at 100 psi air pressure)	.05	4.0	1.1	9.0	1.6	12.6	2.6	20.6	3.2	26.0	5.5	44.2	8.0	63.6	10.3	82.5	XA Series	108	
	1.0	5.9	2.2	13.4	3.1	18.8	5.2	30.9	6.5	39.0	11.0	66.3	15.9	95.5	20.6	123.9	Turbo II Pump	106	
	1.2	7.4	2.7	16.8	3.8	23.6	6.2	38.6	7.8	48.7	13.3	82.9	19.1	119.3	24.8	154.7	PA-133	104	
	.09	6.6	.21	14.9	.29	20.9	.48	34.3	.60	43.3	1.0	73.7	1.5	106.0	1.9	137.5	PAM 10-Series	105	
	.07	.74	.16	1.7	.22	2.4	.36	3.9	.46	4.9	.78	8.3	1.1	11.9	1.5	15.5	ZA4 Series	110	
Gasoline	0.08	0.59	0.19	1.3	0.27	1.9	0.44	3.1	0.56	3.9	0.95	6.6	1.4	9.5	1.8	12.4	ZG5 Series, Briggs	112	
	0.15	0.59	0.34	1.3	0.47	1.9	0.77	3.1	0.97	3.9	1.7	6.6	2.4	9.5	3.1	12.4	ZG5 Series, Honda	112	
	0.07	0.30	0.15	0.67	0.21	0.94	0.34	1.5	0.43	1.9	0.74	3.3	1.1	4.8	1.4	6.2	ZG6 Series	113	

No Load indicates the plunger speed as the plunger extends toward the load (1st stage).

Load indicates the plunger speed as the load is lifted at a system pressure of 10,000 psi (2nd stage).

Formula V = A ÷ Q

$$V \text{ (sec/in)} = A \text{ (in}^2\text{)} \div Q \text{ (in}^3\text{/min)}$$

V = Cylinder plunger speed in seconds per inch

A = Cylinder effective area in square inches

Q = Pump oil flow in cubic inches

Example: At what speed (V) will the RC-308 (30 ton) cylinder move when powered by a ZE3 electric driven pump?

RC-308 Cylinder effective area A = 6.50 in²
ZE3 pump oil flow Q, (no load) is 450 in³/min
V = 6.50 in² ÷ 450 in³/min x 60 = .87 sec/in

$$\text{Cylinder Plunger Speed (sec/in)} = \frac{\text{Cylinder Effective Area}}{\text{Pump Flow Rate}} \times \frac{60 \text{ sec}}{1}$$



Ways

The (oil) ports on a valve.

A 3-way valve has 3 ports: pressure (P), tank (T), and cylinder (A).

A 4-way valve has 4 ports: pressure (P), tank (T), advance (A) and retract (B).

Single-acting cylinders require at least a 3-way valve, and can, under certain instances, be operated with a 4-way valve.

Double-acting cylinders require a 4-way valve, providing control of the flow to each cylinder port.

Positions

The number of control points a valve can provide. A 2-position valve has the ability to control only the advance or retraction of the cylinder. To be able to control the cylinder with a hold position, the valve requires a 3rd position.

Center Configuration

The center position of a valve is the position at which there is no movement required of the hydraulic component, whether a tool or cylinder.

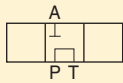

The most common is the **Tandem Center**. This configuration provides for little to no movement of the cylinder and the unloading of the pump.

This provides for minimum heat build-up.

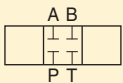

The next most common is the **Closed Center** configuration, which is used

mostly for independent control of multi-cylinder applications. This configuration again provides for little to no movement of the cylinder, but also dead-heads the pump, isolating it from the circuit. Use of this type of valve may require some means of unloading the pump to prevent heat build-up.

There are many more types of valves, such as Open Center and Float Center. These valves are used mostly in complex hydraulic circuits and require other special considerations.

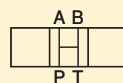

Open Center

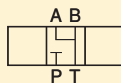

Float Center

Directional Control Valves

3-Way Valves are used with single-acting cylinders

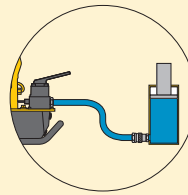

4-Way Valves are used with double-acting cylinders

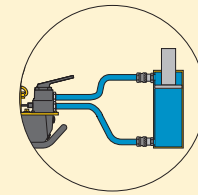

Valves may be either pump mounted or remote mounted.	Pump Mounted	Remote Mounted
Valves may be either manually or solenoid operated.	Manually Operated	Solenoid Operated

Advance Hold Retract

Single-acting cylinder Controlled by a 3-way, 3-position valve.

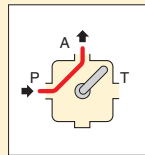

Advance

The oil flows from the pump pressure port P to the cylinder port A: the cylinder plunger will extend.

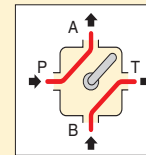

Advance

The oil flows from the pump pressure port P to the cylinder port A, and from cylinder port B to tank T: the cylinder plunger will extend.

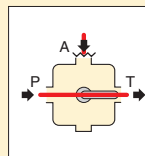

Hold

The oil flows from the pump pressure port P to the tank T.

The cylinder port A is closed: the cylinder plunger will maintain its position.

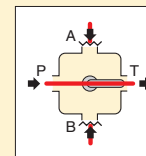

Hold

The oil flows from the pump pressure port P to the tank T. The cylinder ports A and B are closed: the cylinder plunger will maintain position.

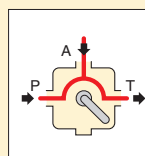

Retract

The oil flows from the pump port P and cylinder port A to the tank T: the cylinder plunger will retract.

A to the tank T: the cylinder plunger will retract.

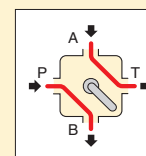

Retract

The oil flows from the pump pressure port P to cylinder port B, and from cylinder port A to tank T: the cylinder plunger will retract.

port B, and from cylinder port A to tank T: the cylinder plunger will retract.

Hexagon Nut and Bolt Sizes



METRIC SIZES

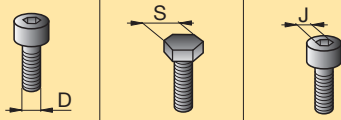

Thread Size D (mm)	Hexagon Size S (mm)	Hexagon Size J (mm)
M 10	17	8
M 12	19	10
M 14	22	12
M 16	24	14
M 18	27	14
M 20	30	17
M 22	32	17
M 24	36	19
M 27	41	19
M 30	46	22
M 33	50	24
M 36	55	27
M 39	60	27 (30)
M 42	65	32
M 45	70	-
M 48	75	36
M 52	80	36
M 56	85	41
M 60	90	46
M 64	95	46
M 68	100	50
M 72	105	55
M 76	110	60
M 80	115	65
M 85	120	70
M 90	130	70 (75)
M 95	135	-
M 100	145	85
M 105	150	-
M 110	155	-
M 115	165	-
M 120	170	-
M 125	180	-
M 130	185	-
M 140	200	-
M 150	210	-

IMERIAL SIZES

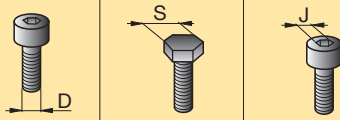

Thread Size D (in)	Hexagon Size * S (in)	Hexagon Size J (in)
5/8"	1 1/16"	1/2"
3/4"	1 1/4"	5/8"
7/8"	1 7/16"	3/4"
1"	1 5/8"	3/4"
1 1/8"	1 13/16"	7/8"
1 1/4"	2"	7/8"
1 3/8"	2 3/16"	1"
1 1/2"	2 3/8"	1"
1 5/8"	2 9/16"	-
1 3/4"	2 3/4"	1 1/4"
1 7/8"	2 15/16"	1 3/8"
2"	3 1/8"	1 5/8"
2 1/4"	3 1/2"	1 3/4"
2 1/2"	3 7/8"	1 7/8"
2 3/4"	4 1/4"	2"
3"	4 5/8"	2 1/4"
3 1/4"	5"	2 1/4"

* Heavy hexagon nuts.



Determine the maximum torque according to the bolt (nut) size and grade. Always consult the manufacturers instructions or engineering recommendations when making bolted connections.



IMPORTANT

The hexagon sizes shown in the tables should be used as a guide only. Individual sizes should be checked before specifying any equipment.



BSH-Series Sockets

Use only Heavy Duty Impact Sockets for power driven torquing equipment, according to ISO2725 and ISO1174; DIN3129 and DIN3121 or ASME-B107.2/1995.



Tightening Methods

Principally there are two modes of tightening: "Uncontrolled" and "Controlled".

Uncontrolled tightening

Uses equipment and/or procedures that cannot be measured. Preload is applied to a bolt and nut assembly using a hammer and spanner or other types of impact tools.

Controlled tightening

Employs calibrated and measurable equipment, follows prescribed procedures and is carried out by trained personnel.

Advantages of Controlled Tightening

Known, controllable and accurate bolt loads

Employs tooling with controllable outputs and adopts calculation to determine the required tool settings.

Uniformity of bolt loading

Especially important on gasketed joints as an even and consistent compression is required for the gasket to be effective.

Safe operation following prescribed procedures

Eliminates the dangerous activities of manual uncontrolled tightening and requires that the operators be skilled and follow procedures.

Reduces operational time resulting in increased productivity

Reduces tightening time and operator fatigue by replacing manual effort with the use of controlled tooling.

Reliable and repeatable results

Using calibrated, tested equipment, following procedures and employing skilled operators achieves known results consistently.

The right results first time

Many of the uncertainties surrounding in-service joint failures are removed by ensuring the correct assembly and tightening of the joint are carried out the first time.



Bolting Integrity Software

A comprehensive on-line software solution for Bolted Joint integrity.

Integral databases hold data for:

- BS1560, MSS SP44, API 6A and 17D flanged joints
- Common gasket materials and configurations
- Comprehensive range of bolt materials
- Comprehensive range of lubricants
- Enerpac's Controlled Bolting Equipment including: Torque Multipliers, Hydraulic Wrenches and Bolt Tensioning tools

Custom Joint information can also be entered.

The software offers Tool selection, Bolt Load calculations and Tool pressure settings, as well as, a combined Application data sheet and Joint completion report.

www.enerpac.com

What is Torque?

It is a measure of how much force acting on an object which causes that object to rotate.

What is Torque Tightening?

The application of preload to a fastener by the turning of the fastener's nut.

Torque Tightening and Preload

The amount of preload created when torquing is largely dependant on the effects of friction.

Principally there are three different "torque components":

- torque to stretch the bolt
- torque to overcome the friction in bolt and nut threads
- torque to overcome friction at the nut spot face (bearing contact surface).

Torque Tightening

Turning movement

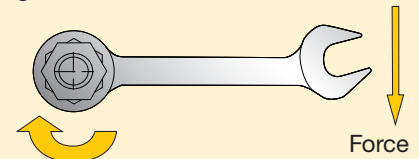

Stretch of Fastener (Pre-load)

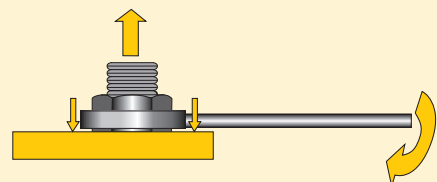



Preload (residual load) = Applied Torque *minus* Frictional Losses

Lubrication Reduces Friction

Lubrication reduces the friction during tightening, decreases bolt failure during installation and increases bolt service life. Variation in friction coefficients affect the amount of preload achieved at a specified torque. Higher friction results in less conversion of torque to preload. The value for the friction coefficient provided by the lubricant manufacturer must be known to accurately establish the required torque value.

Lubricant or anti-seize compounds should be applied to both the nut bearing surface and the male threads.

Frictional Losses

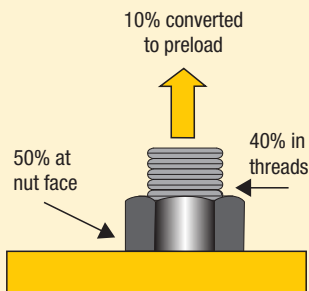

Frictional Losses (dry steel bolt)

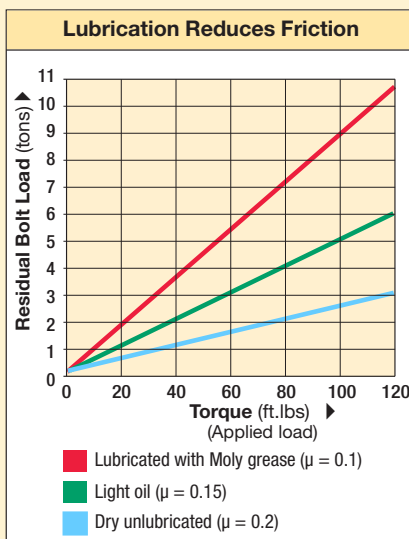

Example of how a lubricant can reduce the effect of friction and convert more torque to bolt preload.

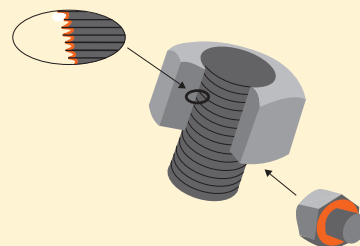

Friction points should always be lubricated when using the torque tightening method.



Select the Right Wrench

Choose your Enerpac torque wrench using the untightening rule of thumb:

- When loosening a nut or bolt more torque is usually required than when tightening.
- For general conditions it can take up to 2½ times the input torque to breakout.
- Do not apply more than 75% of the maximum torque output of the tool when loosening nuts or bolts.

Conditions of bolted joints

- Humidity corrosion (rust) requires up to twice the torque required for tightening.
- Sea water and chemical corrosion requires up to 2½ times the torque required for tightening.
- Heat corrosion requires up to 3 times the torque required for tightening.

Torque Procedure

When torquing it is common to tighten only one bolt at a time, this can result in Point Loading and Load Scatter. To avoid this, torque is applied in stages following a prescribed pattern:

Torque Sequence

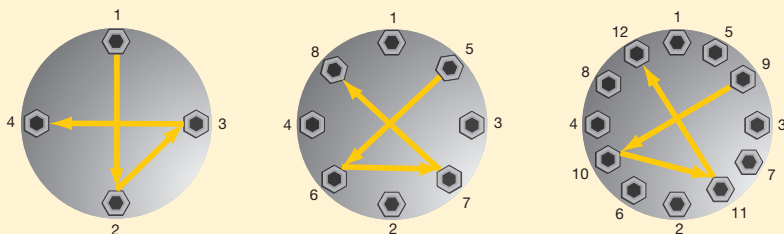

- Step 1** Spanner tight ensuring that 2 - 3 threads extend above nut.
- Step 2** Tighten each bolt to one-third of the final required torque following the pattern as shown above.
- Step 3** Increase the torque to two-thirds following the pattern shown above.

- Step 4** Increase the torque to full torque following the pattern shown above.
- Step 5** Perform one final pass on each bolt working clockwise from bolt 1, at the full final torque.



Breakout Torque

When loosening bolts a torque value higher than the tightening torque is normally required.

This is mainly due to corrosion and deformations in the bolt and nut threads.

Breakout torque cannot be accurately calculated, however, depending on conditions it can take up to 2½ times the input torque to breakout.

The use of penetrating oils or anti-seize products is always recommended when performing breakout operations.



Tensioning requires longer bolts



INCORRECT

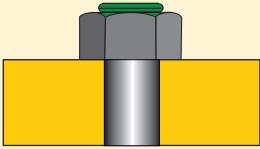

CORRECT

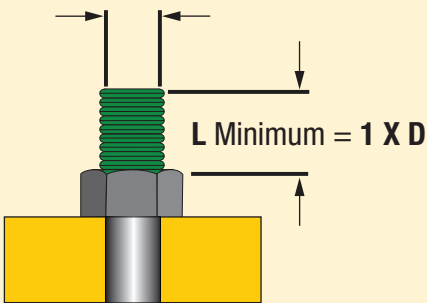

What is Bolt Tensioning

Tensioning is the direct axial stretching of the bolt to achieve **preload**. Inaccuracies created through friction are eliminated. Massive mechanical effort to create torque is replaced with simple hydraulic pressure. A uniform load can be applied by tensioning multiple studs simultaneously.

Tensioning requires longer bolts, and a seating area on the assembly around the nut. Tensioning can be done using detachable Bolt Tensioners or Hydraulic Nuts.



Preload (residual load) = Applied Load minus Load Losses

What is Load Loss

Load loss is a loss of bolt elongation depending on factors such as thread deflections, radial expansion of the nut, and embedding of the nut into the contact area of the joint. Load loss is accounted for in calculation and is added to the preload value to determine the initial **Applied Load**.

The preload depends on Applied Load and Load Loss (load loss factor).



GLOSSARY OF TERMS

Applied Load: The load applied to a bolt during tensioning which includes an allowance for Load Loss.

Bolt Tensioning: A method of controlled tightening which applies preload to a bolt by stretching it axially.

Breakout Torque: The amount of torque required to loosen a tightened bolt. (Usually more torque is required to loosen a bolt than was used to tighten it.)

Elastic Range: The range on a bolt's stress / strain curve where stress is directionally proportional to strain.

Load Loss: The losses in a bolt which occur on transfer of load from a tensioning device to the bolt assembly (these may arise from phenomena such as thread deflection and embedding of

the nut to the contact area of the joint, and is calculated as a factor of the length to diameter ratio of the bolt).

Load Scatter: The spread of differing loads in a sequence of bolts after they have been loaded. It is mostly due to the elastic interaction of the bolts and the joint member; as subsequently tightened bolts further compress the joint, previously tightened bolts are subject to some relaxation.

Plastic Range: The range on a stress/strain curve where the tensile load applied to a bolt results in permanent deformation.

Preload: The load in a bolt immediately after it has been tightened.

Proof Load: Proof load is often used interchangeably with Yield Strength but is usually measured at 0.2% plastic strain.

Tensile Point: The point at which the tensile loading on a bolt causes the bolt to rupture.

Torque Tightening: The application of Preload to a bolt by turning of the bolt's nut.

Ultimate Strength: The maximum tension which can be created by tensile load on a bolt.

Yield Strength: The point at which a bolt begins to plastically deform under tensile loading.

NOTE: Bolt is used as a generic term for a threaded fastener.



Manufacturer's rating of pressure and load are maximum safe limits. Good practice encourages using only 80% of these ratings!

Tensioning Operation

Tensioning permits the simultaneous tightening of multiple bolts; the tools are connected in sequence via a high-pressure hose assembly to a single pump unit. This ensures each tool develops the exact same load and provides a uniform clamping force across the joint. This is especially important for pressure containing vessels requiring even gasket compression to affect a seal.

General Procedure

- Step 1:** The bolt Tensioner is fitted over the stud
- Step 2:** Hydraulic pressure is applied to the tensioner which then stretches the stud.
- Step 3:** The Stud's nut is wound down against the joint face
- Step 4:** Pressure is released and the tool removed.

The bolt behaves like a spring, when the pressure is released the bolt is under tension and attempts to contract, creating the required clamping force across the joint.

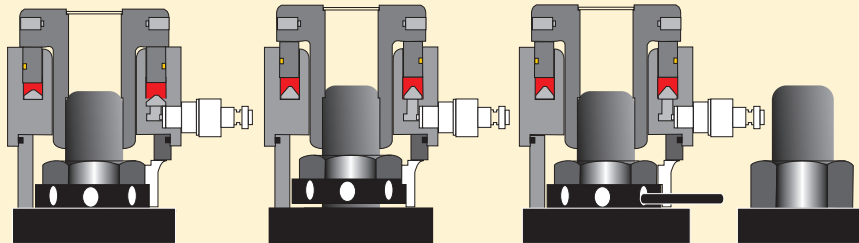

Step 1

Step 2

Step 3

Step 4

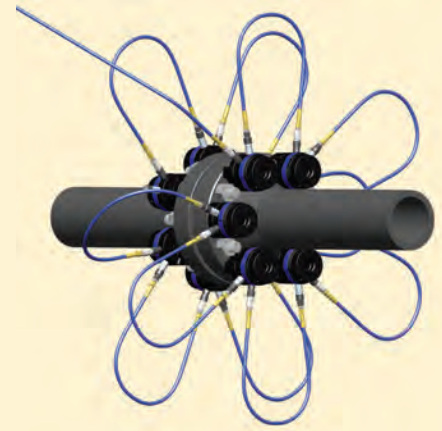

Set-up using a 100% tensioning procedure

All bolts are tensioned simultaneously.

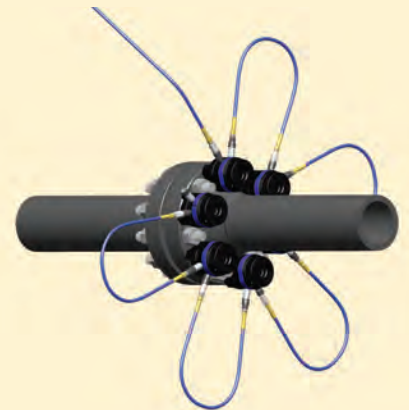

Set-up using a 50% tensioning procedure

Half the bolts are tensioned simultaneously, the tools are relocated on the remaining bolts and they are subsequently tensioned.

Less than 100% Tensioning

Not all applications allow for the simultaneous fit of a tensioning device on each bolt, in these cases at least two tensioning pressures are applied. This is to account for a load loss in those bolts already tensioned as the next sets are tightened. The load losses are accounted for in calculation and a higher load is applied to allow the first sets to relax back to the target preload.



Read Instruction Manuals

Please refer to the product Instruction Sheets for safe use guidelines and detail on the correct set up and operation of the equipment.

Enerpac manufactures high-force hydraulics (cylinders, pumps, valves, presses, pullers, tools, accessories and system components) for industry and construction and provides hydraulic workholding and OEM solutions to industries worldwide.

With an 80-year history of quality and innovation, the broadest line in the business, and more than 4,000 distributors and factory-trained service centers around the world, Enerpac leads the industry by setting new standards in design, strength, durability and local support. Strict quality programs, zero tolerance for defects, and ISO-9001 certification are your assurance of safe, trouble-free operation.

Enerpac is ready to tackle your toughest challenge and provide the hydraulic advantage you need to increase productivity, labor efficiency and speed of operation.



www.enerpac.com for latest Enerpac information

- Learn more about hydraulics
- Promotions
- New products
- Electronic Catalogs
- Trade shows
- Manuals (instruction and repair sheets)
- Nearest Distributors & Service Centers
- Enerpac products in action
- Heavy Lifting Technology

Ordering Products and Catalogs

To find the name of the closest Enerpac distributor or service center, to request literature or technical application assistance, contact Enerpac at: **enerpac.com/contact-us**

Enerpac catalogs/brochures to meet your needs:

To obtain your copy just give us a call, or visit our Internet site **www.enerpac.com**

E413, Bolting Solutions Catalog: Caters to the complete bolting workflow, ensuring joint integrity in a variety of applications throughout industry, including: joint assembly, controlled tightening and joint separation.



E215, Workholding Catalog: Offers innovative products and solutions to provide powerful clamping and positioning force to every type of manufacturing process. Enerpac Workholding solutions increase product quality and production output.



While every care has been taken in the preparation of this catalog and all data contained within is deemed accurate at the time of printing, Enerpac does reserve the right to make changes to the specifications of any product, or discontinue any product, contained within this catalog without prior notice.

All illustrations, performance specifications, weights and dimensions reflect the nominal values and slight variations may occur due to manufacturing tolerances. Please consult Enerpac if final dimensions are critical.

All information in this catalog can be changed due to product improvements without prior notice.

© Copyright 2017, Enerpac.

All rights reserved. Any copying or other use of material in this catalog (text, illustrations, drawings, photos) without express written consent is prohibited.

Enerpac Academy - The Power of Knowledge



The Enerpac Academy is our in-house training program, offering Enerpac product operators and maintenance staff the opportunity to be trained in the use and maintenance of high-pressure hydraulic tools.

Operating these tools requires sound knowledge of how they work and how they should be maintained. Correct use of these tools increases safety and reduces risk – both for the operator and the environment in which the tools are used. Having the right training enables the operator to use the tools safely and properly.



Enerpac Academy

- Safety focus for operators, tools and environment
- Dedicated in-house Enerpac training centers
- Both standard training courses and specialized training services
- Highly experienced trainers
- Selection of training courses with a proven (value-added) track record
- Knowledge and experience sharing

In-house Training Centers

Do you work with high-pressure hydraulic tools on a regular basis or even every day? The training courses are designed to be highly interactive with a strong hands-on element. Each training course is led by a qualified trainer, an Enerpac specialist capable of providing high quality training. A written or practical exam is part of certain training courses.



Training Center Locations

- Columbus, Wisconsin (USA)
- Ede (The Netherlands)
- Hosur, Bangalore area (India)
- Singapore
- Sydney (Australia)

Enerpac Academy offers a meticulously compiled training program covering tool knowledge, repairs and maintenance, and safe operation of Enerpac hydraulic tools. If you would like to schedule a training course, please contact Enerpac for a training calendar, application form, and brochure at www.enerpac.com.



<http://www.enerpac.com/en/enerpac-locations>

Africa (South Africa and other English speaking African countries)

ENERPAC AFRICA (PTY) Ltd.
5 Bauhinia Avenue
Cambridge Office Park, Block E
Highveld Techno Park, Centurion
0157, Republic of South-Africa
T +0027 (0) 12 940 0656

Australia and New Zealand

Actuant Australia Ltd.
P.O. Box 6867, Wetherill Park, NSW 1851
Block V Unit 3, Regents Park Estate
391 Park Road, Regents Park, NSW 2143
Australia
T +61 287 177 200
F +61 297 438 648

Brazil

Power Packer do Brasil Ltda.
Rua Luiz Lawrie Reid, 548
09930-760 - Diadema (SP)-Brasil
T +55 11 5687 2211
Toll Free: 0800 891 5770

China (Taicang)

Actuant (China) Industries Co. Ltd.
No.6 Nanjing East Road
Taicang Economic Dep Zone
Jiangsu, China
T +86 0512 5328 7500
F +86 0512 5335 9690
Toll Free: +86 400 885 0369

Enerpac Heavy Lifting Technology B.V

Spinelstraat 15, 7554 TW Hengelo
PO Box 421, 7550 AK Hengelo
The Netherlands
T +31 74 242 20 45
F +31 74 243 03 38

France, Switzerland, North Africa and French speaking African countries

ENERPAC
Une division d'ACTUANT
France S.A.S.
Zone Orlytech, Bâtiment 516
1 allée du commandant Mouchotte
CS 40351
91550 Paray-Vieille-Poste, France
T +33 1 60 13 68 68
F +33 1 69 20 37 50

Germany and Austria

Actuant GmbH
PO Box 300113
D-40401 Düsseldorf
Willstätterstrasse 13
D-40549 Düsseldorf, Germany
T +49 211 471 490
F +49 211 471 49 28

India

Actuant India Private Limited
No. 10, Bellary Road, Sadashivanagar
Bangalore, Karnataka 560 080, India
T +91 80 3928 9000

Italy

ENERPAC SPA
Via Leonardo da Vinci, 97
20090 Trezzano S/N
Milano Italy
T +39 02 4861 111
F +39 02 4860 1288

Japan

Enerpac Co., Ltd
Besshocho 85-7
Kita-ku, Saitama-shi 331-0821, Japan
T +81 48 662 4911
F +81 48 662 4955

Middle East, Egypt and Libya

ENERPAC Middle East FZE
Plot M00737m 1242nd Street
Jebel Ali Free Zone North
P.O. Box 18004, Dubai
United Arab Emirates
T +971 (0)4 8872686
F +971 (0)4 8872687

Norway

Sales Office Norway
Unit 524, Nydalsveien 28, 0484 Oslo
P.O. Box 4814 Nydalen 0422 Oslo
Norway
Tel: +47 91 578 300

Russia

Rep. office Enerpac
Russian Federation
Admiral Makarova Street 8
125212 Moscow, Russia
T +7 495 98090 91
F +7 495 98090 92

Southeast Asia, Hong Kong and Taiwan

Actuant Asia Pte Ltd.
83 Joo Koon Circle,
Singapore 629109
T +65 68 63 0611
F +65 64 84 5669
Toll Free: +1800 363 7722

South Korea

Actuant Korea Ltd.
3Ba 717, Shihwa Industrial Complex
Jungwang-Dong, Shihung-Shi
Kyunggi-Do, Republic of Korea 429-450
T +82 31 434 4506
F +82 31 434 4507

Spain and Portugal

ENERPAC SPAIN, S.L.
Avenida Valdelaparra N° 27 3ª - L8
28108 Alcobendas
(Madrid) Spain
T +34 91 884 86 06
F +34 91 884 86 11

Sweden, Denmark, Finland and Iceland

Enerpac Scandinavia AB
Kopparlundsvägen 14,
721 30 Västerås, Sweden
T +46 (0) 771 415000

The Netherlands, Belgium, Luxembourg, Central and Eastern Europe, Baltic States, Greece, Turkey and CIS countries

ENERPAC B.V.
Galvanistraat 115, 6716 AE Ede
P.O. Box 8097, 6710 AB Ede
The Netherlands
T +31 318 535 911
F +31 318 535 848

United Kingdom and Ireland

ENERPAC UK Ltd.,
5 Coopies Field
Morpeth, Northumberland
NE61 6JR, England
Tel: +44 1670 5010 00

USA, Latin America and Caribbean

ENERPAC World Headquarters
P.O. Box 3241
Milwaukee, WI 53201-3241 USA
N86 W12500 Westbrook Crossing
Menomonee Falls, Wisconsin 53051
T +1 262 293 1600
F +1 262 293 7036
User inquiries:
+1 800 433 2766
Distributor inquiries/orders:
+1 800 558 0530
+1 800 628 0490
Technical inquiries:
Technical inquiries:
enerpac.com/en/contact-us

06/01/17



Cylinders, Lifting Products & Systems

Pages 4–67



Pumps & Directional Control Valves

Pages 68–129



System Components & Control Valves

Pages 130–147



Presses

Pages 148–161



Pullers

Pages 162–181



Tools

Pages 182–201



Bolting Tools

Pages 202–259



Heavy Lifting Solutions

Pages 260–272

Africa (South Africa and other English speaking African countries)

Enerpac Africa (PTY) Ltd.
Tel: +0027 (0) 12 940 0656

Australia and New Zealand

Actuant Australia Ltd.
Tel: +61 287 177 200 – Fax: +61 297 438 648

Brazil

Power Packer do Brasil Ltda.
Tel: +55 11 5687 2211
Toll Free: 0800 891 5770

China (Taicang)

Actuant (China) Industries Co., Ltd.
Toll Free: +86 400 885 0369
Tel: +86 0512 5328 7500 – Fax: +86 0512 5335 9690

Enerpac Heavy Lifting Technology B.V.

Tel: +31 74 242 20 45 – Fax: +31 74 243 03 38

France, Switzerland, Africa (North Africa and French speaking African countries)

ENERPAC
Tel: +33 1 60 13 68 68 – Fax: +33 1 69 20 37 50

Germany and Austria

ENERPAC GmbH
Tel: +49 211 471 490 – Fax: +49 211 471 49 28

India

ENERPAC Hydraulics Pvt. Ltd.
Tel: +91 80 3928 9000

Italy

ENERPAC S.p.A.
Tel: +39 02 4861 111 – Fax: +39 02 4860 1288

Japan

Enerpac Co., LTD
Tel: +81 48 662 4911 – Fax: +81 48 662 4955

Middle East, Egypt and Libya

ENERPAC Middle East FZE
Tel: +971 (0)4 8872686 – Fax: +971 (0)4 8872687

Norway

Sales Office Norway
T. +47 91 578 300

Russia

Rep. office Enerpac
Tel: +7 495 98090 91 – Fax: +7 495 98090 92

Southeast Asia, Hong Kong and Taiwan

Actuant Asia Pte Ltd.
Tel: +65 68 63 0611 – Fax: +65 64 84 5669
Toll Free: +1800 363 7722

South Korea

Actuant Korea Ltd.
Tel: +82 31 434 4506 – Fax: +82 31 434 4507

Spain and Portugal

ENERPAC SPAIN, S.L.
Tel: +34 91 884 86 06 – Fax: +34 91 884 86 11

Sweden, Denmark, Finland and Iceland

Enerpac Scandinavia AB
Tel: +46 (0) 771 415000

The Netherlands, Belgium, Luxembourg, Central and Eastern Europe, Baltic States, Greece, Turkey and CIS countries

ENERPAC B.V.
Tel: +31 318 535 911 – Fax: +31 318 535 848

United Kingdom and Ireland

ENERPAC Ltd.
Tel: +44 1670 5010 00

USA, Latin America and Caribbean

ENERPAC
Tel: +1 262 293 1600 – Fax: +1 262 293 7036

User inquiries: +1 800 433 2766

Distributor inquiries/orders:

Tel: +1 800 558 0530 – Fax: +1 800 628 0490

For complete list of addresses: page 292

www.enerpac.com

Enerpac © 2017
100 EN-US



ENERPAC

POWERFUL SOLUTIONS. GLOBAL FORCE.