



# ⚠ WARNING

Before purchasing Dixon® products, you should be aware and make your customers aware of certain warnings. Such warnings are found on page 1103 and the inside back cover of the catalog.

## Table of Contents

### King Crimp® Fittings



Male and female fittings, ferrules and crimp sleeves, combination nipples, couplers, coupling inserts

**A** pgs. 4-17

### Cam & Groove



Dixon®, Boss-Lock, EZ Boss-Lock, EZLink®, swaged-on, phonograph finish, reducing couplers, adapters, gaskets, replacement handles, accessories, Strap-Grip

**B** pgs. 18-90

### Engineered Fluid Transfer Couplings



Dry disconnect couplers and adapters, safety breakaways, fluid nozzles, API couplers, vapor recovery couplers, pipe caps, drop elbows, swivel joints, railroad unloading assemblies, ADS fluid controls

**C** pgs. 91-150

### Boss®



Boss ground joint and washer type couplings, male and LP stems, Boss clamps, air hammer fittings, hammer unions

**D** pgs. 151-178

### Pneumatic Fittings



Sand blast couplings, Surelock™ hose ends, Dix-Lock® Dual-Lock, Air Chief industrial and automotive male and female fittings, Parker E-Z mate industrial couplers, air brake fittings

**E** pgs. 179-258

### Pneumatic Accessories



King safety cables, air receiver manifolds, FRL's, blow guns, gauges, thermometers, air tool lubricant, mufflers, vents, manifolds

**F** pgs. 259-356

### Shank Water Fittings



Menders, nipples, suction couplings, foot valves, strainers, skimmers, long and short fittings, spray hose couplings, quick connects, inserts

**G** pgs. 357-391

### Washdown and Garden Hose Accessories



Menders, nozzles, quick-connects, hose, swivels, hose barbs fittings, forged valves, couplers, coil hose, screens, straight through's

**H** pgs. 392-424

### Brass Fittings



Hose stations, nozzles, garden hose fittings, shank fittings, ferrules, crimping tools, pressure gun and accessories, grease whip assemblies, push-on fittings, short shank fittings

**I** pgs. 425-458

### Clamps



Worm gear clamps, t-bolt clamps, single and double bolt clamps, spiral clamps, clamp hand tools, single and double ear clamps, band clamps

**J** pgs. 459-479

### Hydraulic Couplings, Adapters, and Valves



Couplings, food grade couplers, dust caps and plugs, threaded plugs, hose barbs, extension plugs, push-loc barbs, blowout prevention safety couplers, wingstyle threaded couplers, connectors, elbows, tees, bolt flanges, pipe and tube clamps, high-pressure valves

**K** pgs. 480-570

### Holedall® Fittings



Rams, Holedall externally swaged fittings, flanged assemblies, Holedall internally expanded fittings, sanitary fittings, Holedall petroleum fittings, petroleum coupling expanders

**L** pgs. 571-593

Table of Contents

**Sanitary / Hygienic Fittings**



Clamp fittings, weld fittings, bevel seat fittings, John Perry, Q-Line and I-line fittings, butt weld fittings, tube O.D. fittings, hangers, ball valves, butterfly valves, check valves **M** pgs. 594-749

**Fire Hose, Fittings, and Accessories**



Hose, reels, connections, wrenches, hydrant adapters, swivels, nipples, valves, thermoplastic, nozzles, Storz fittings, LDH hardware **N** pgs. 750-873

**Valves**



Ball valves, mini ball valves, industrial wafer ball valves, nozzle valves, butterfly valves, flow control valves, needle valves **O** pgs. 874-916

**Pipe, Weld, and Tube Fittings**



NPT threaded pipe fittings, pipe nipples, swage nipples, hammer unions, instrumentation fittings, SAE flare fittings, push to connect fittings **P** pgs. 917-997

**Plastic Fittings and Tubing**



Quick disconnect fittings, PVC tubing, tubing cutters, Tuff-Lite® nylon and polypropylene hose fittings, acetal fittings, push-in fittings **Q** pgs. 998-1011

**PTFE Hose and Fittings**



Nominal fittings, true I.D. fittings, smooth bore PTFE conductive and non-conductive hose, open pitch convoluted hose, heavy wall true I.D. smooth bore hose **R** pgs. 1012-1018

**Tank Truck Fittings**



Tight and loose fill couplers and adapters, shank couplings, pipe caps, sight flow indicators, reducers and adapters for tank trucks, hose swivels, hose nozzles, rack cords, dry disconnects, nozzles **S** pgs. 1019-1052

**Maintenance and Repair**



Thread tape and sealant, hydrostatic test pumps, spill kits, grease whip hose assemblies and fittings, oxy-acetylene fittings, torque wrenches **T** pgs. 1053-1070

**Dixon Retail Displays**



Retail displays for pressure washer, garden hose, pneumatic, hydraulic, and outside air products **U** pgs. 1071-1101

**Safety and Technical**



Dixon hose coupling workshop, SOS van, safety information, corrosion resistance of coupling material, thread information, flange dimensions, conversion charts **V** pgs. 1102-1143

**Index**

Part number and product description index **W** pgs. 1144-1190

A  
B  
C  
D  
E  
F  
G  
H  
I  
J  
K  
L  
M  
N  
O  
P  
Q  
R  
S  
T  
U  
V  
W

**Cam & Groove**



Venting EZ Boss-Lock  
page 24



Swivel Couplings  
page 25



EZ Boss-Lock Type C Jump  
Size Couplers  
page 56



Type F 15° Elbows  
page 60

**Engineered Fluid Transfer Couplings**



5500-Series API Couplers  
page 139



Bayonet Style Dry Disconnects  
pages 96 - 97



A240-Series Ground  
Verification Monitor  
page 148



A540-Series Ground Clamp  
and Junction Box  
page 148

**Pneumatic Accessories**



Whip Hose Assemblies  
page 265



Series 1 FRLs  
B17 Filter / Regulator  
page 328

**Shank Water Fittings**



Flexible Strainers  
page 390

**Washdown and Garden Hose Accessories**



Heavy-Duty Hot Water Nozzle  
page 413

### Hydraulic Couplings, Adapters, and Valves



XK-Series  
Hydraulic Couplings  
page 511



High-Pressure Clear Zinc  
Ball Valve  
page 561

### Holedall® Fittings

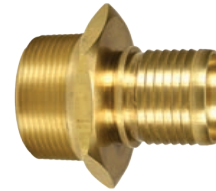

Crimp Fuel Couplings  
page 584

### Sanitary / Hygienic Fittings



Clever Clamp™  
page 595



Sanitary Filtration Housing System  
pages 727

### Fire Hose Fittings and Accessories



Viper™ Nozzles  
page 794



Storz Live Swivel  
page 824

### Pipe, Weld, and Tube Fittings



Boss® Ductile Flanges  
page 955

### Tank Truck



EZ Boss-Lock Vapor Recovery  
Coupler with Probe x TTMA Flange  
page 1034

### Dixon Retail Displays



Hydraulic and Outside Air Display  
pages 1090, 1094

**A King Crimp ..... 5 - 17**

- Crimp working pressure chart .....5
- Type C .....6
- Type E .....7
- Global type C .....7
- Global type E .....8
- Combination nipples .....9
  - Threaded end..... 9
  - Grooved end..... 9
  - Beveled end. .... 9
  - FJIC..... 9
- King Crimp style flanges.....10
  - 150# ASA fixed flanges.....10
  - Nipples x TTMA flanges.....10
  - Nipples for floating flanges .....10
- Sanitary stems .....11
- Short combination nipples .....11
- Short ferrules.....11
- Combination nipples, heavy-duty, threaded end.....12
- Heavy-duty ferrules .....12
- Ferrules.....13 - 14
- Sleeves.....15 - 16
- Large sleeves.....17

### Crimp Working Pressure Chart

Size	Temperature	Fitting	Clamp	Working Pressure PSIG	Size	Temperature	Fitting	Clamp	Working Pressure PSIG
1"	Ambient	STC10CS	sleeve	400	3"	Ambient	STC35CS	sleeve	200
	160°F (71°C)			270		160°F (71°C)			140
	180°F (82°C)			250		180°F (82°C)			100
	250°F (121°C)			200		250°F (121°C)			75
	Ambient	STC10CS	ferrule	400		Ambient	STC35CS	ferrule	300
	160°F (71°C)			270		160°F (71°C)			218
	180°F (82°C)			250		180°F (82°C)			200
	250°F (121°C)			200		250°F (121°C)			100
	Ambient	100-C/E	sleeve	250		Ambient	300-C/E	sleeve	125
	160°F (71°C)			242		160°F (71°C)			100
	180°F (82°C)			240		180°F (82°C)			60
	250°F (121°C)			200		250°F (121°C)			55
	Ambient	100-C/E	ferrule	250		Ambient	300-C/E	ferrule	150
	160°F (71°C)			242		160°F (71°C)			125
	180°F (82°C)			240		180°F (82°C)			100
	250°F (121°C)			200		250°F (121°C)			75
1-1/2"	Ambient	STC20CS	sleeve	300	4"	Ambient	STC40CS	sleeve	175
	160°F (71°C)			225		160°F (71°C)			100
	180°F (82°C)			200		180°F (82°C)			100
	250°F (121°C)			100		250°F (121°C)			50
	Ambient	STC20CS	ferrule	350		Ambient	STC40CS	ferrule	300
	160°F (71°C)			225		160°F (71°C)			218
	180°F (82°C)			200		180°F (82°C)			200
	250°F (121°C)			150		250°F (121°C)			100
	Ambient	150-C/E	sleeve	250		Ambient	400-C/E	sleeve	110
	160°F (71°C)			200		160°F (71°C)			75
	180°F (82°C)			100		180°F (82°C)			60
	250°F (121°C)			75		250°F (121°C)			50
	Ambient	150-C/E	ferrule	250		Ambient	400-C/E	ferrule	150
	160°F (71°C)			200		160°F (71°C)			75
	180°F (82°C)			150		180°F (82°C)			75
	250°F (121°C)			100		250°F (121°C)			75
2"	Ambient	STC25CS	sleeve	250	6"	Ambient	STC60CS	sleeve	75
	160°F (71°C)			150		160°F (71°C)			---
	180°F (82°C)			125		180°F (82°C)			---
	250°F (121°C)			80		250°F (121°C)			---
	Ambient	STC25CS	ferrule	300		Ambient	STC60CS	ferrule	230
	160°F (71°C)			239		160°F (71°C)			---
	180°F (82°C)			225		180°F (82°C)			---
	250°F (121°C)			100		250°F (121°C)			---
	Ambient	200-C/E	sleeve	250		Ambient	600-C/E	sleeve	75
	160°F (71°C)			100		160°F (71°C)			---
	180°F (82°C)			50		180°F (82°C)			---
	250°F (121°C)			50		250°F (121°C)			---
	Ambient	200-C/E	ferrule	250		Ambient	600-C/E	ferrule	75
	160°F (71°C)			100		160°F (71°C)			---
	180°F (82°C)			100		180°F (82°C)			---
	250°F (121°C)			100		250°F (121°C)			---

A

### Dixon® Cam & Groove Type C

#### Coupler x Hose Shank

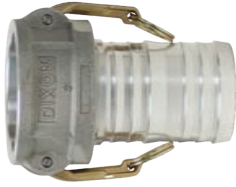

356T6 aluminum

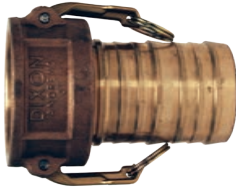

brass



316 stainless steel



unplated ductile iron

**Features**

- Finger rings are not supplied on 1" Dixon couplings
- Couplers are supplied standard with a nitrile rubber gasket; other gasket types are available on pages 68 - 71
- Use Dixon replacement handles only

Hose I.D.	356T6 Aluminum Part #	Brass Part #	316 Stainless Steel Part #	Unplated Ductile Iron Part #
1"	100-C-AL	100-C-BR	100-C-SS*	---
1-1/2"	150-C-AL	150-C-BR	150-C-SS	150-C-MI <sup>1</sup>
2"	200-C-AL	200-C-BR	200-C-SS	200-C-MI
3"	300-C-AL	300-C-BR	300-C-SS	300-C-MI
4"	400-C-AL	400-C-BR	400-C-SS	400-C-MI
6"	600-C-AL	600-C-BR	600-C-SS	600-C-MI

<sup>1</sup> Malleable iron

NOTE: Only use the crimp style shanks with the crimp style sleeves and ferrules. Due to differences in dimensions and tolerances for safety reasons, do not interchange other manufacturers' products with Dixon products.



### EZ Boss-Lock Cam & Groove Type C

#### Coupler x Hose Shank

**Feature**

- Couplers are supplied standard with a nitrile rubber gasket; other gasket types are available on pages 68 - 71



Size	316 Stainless Steel Part #
1"	RC100EZCR
1-1/4"	RC125EZCR
1-1/2"	RC150EZCR
2"	RC200EZCR
3"	RC300EZCR
4"	RC400EZCR
6"	RC600EZCR

NOTE: Under no circumstances should the EZ Boss-Lock cam arms be used on any fitting not specifically designed for their use. See page 20 for further specifications.





## Dixon® Type E Adapters

### Adapter x Hose Shank

Pressure rating is based on the seal of the mating part. See ratings on page 20.



Hose I.D.	356T6 Aluminum Part #	Brass Part #	316 Stainless Steel Part #	Unplated Ductile Iron Part #
1"	100-E-AL	100-E-BR	100-E-SS	---
1-1/2"	150-E-AL	150-E-BR	150-E-SS	---
2"	200-E-AL	200-E-BR	200-E-SS	---
3"	300-E-AL	300-E-BR	300-E-SS	300-E-MI
4"	400-E-AL	400-E-BR	400-E-SS	400-E-MI
6"	600-E-AL	600-E-BR	600-E-SS	600-E-MI



356T6 aluminum

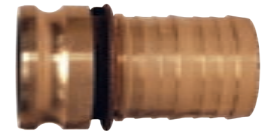

brass



316 stainless steel



unplated ductile iron

## Global Crimp Style Cam & Groove Type C

### Coupler x Hose Shank

#### Features

- All couplers are supplied with safety clips
- Couplers are supplied standard with a nitrile rubber gasket; other gasket types are available on pages 68 - 71
- Use global replacement handles only

Only use the crimp style shanks with the crimp style sleeves and ferrules. Due to differences in dimensions and tolerances for safety reasons, do not interchange other manufacturers' products with Dixon products.



Hose I.D.	A380 Permanent Mold Aluminum Part #	C38000 Forged Brass Part #	316 Investment Cast Stainless Part #
1"	G100-C-ALCR	G100-C-BRCR	G100-C-SSCR
1-1/2"	G150-C-ALCR	G150-C-BRCR	G150-C-SSCR
2"	G200-C-ALCR	G200-C-BRCR	G200-C-SSCR
3"	G300-C-ALCR	G300-C-BRCR	G300-C-SSCR
4"	G400-C-ALCR	G400-C-BRCR	G400-C-SSCR
6"	G600-C-ALCR	---	G600-C-SSCR

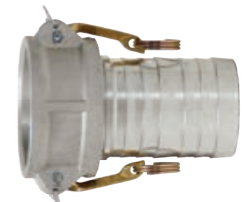

A380 permanent mold aluminum



C38000 forged brass



316 investment cast stainless

A

## Global Crimp Style Cam & Groove Type E

### Adapter x Hose Shank



A380 permanent mold aluminum

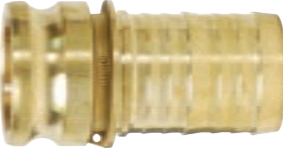

C38000 forged brass

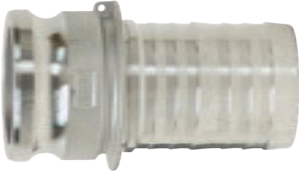

316 investment cast stainless

Only use the crimp style shanks with the crimp style sleeves and ferrules. Due to differences in dimensions and tolerances for safety reasons, do not interchange other manufacturers' products with Dixon® products. Pressure rating is based on the seal of the mating part. See ratings on page 20.



Hose I.D.	A380 Permanent Mold Aluminum Part #	C38000 Forged Brass Part #	316 Investment Cast Stainless Steel Part #
1"	G100-E-ALCR	G100-E-BRCR	G100-E-SSCR
1-1/2"	G150-E-ALCR	G150-E-BRCR	G150-E-SSCR
2"	G200-E-ALCR	G200-E-BRCR	G200-E-SSCR
3"	G300-E-ALCR	G300-E-BRCR	G300-E-SSCR
4"	G400-E-ALCR	G400-E-BRCR	G400-E-SSCR
6"	G600-E-ALCR	---	G600-E-SSCR

## King Crimp Style Combination Nipples

### Threaded End

**Feature**

- There are two grooves on the crimp style King combination nipples. The second groove is the roll stamp groove, which has the part number and "call Dixon®" stamped on it. This groove is a smooth concentric groove so that the stamp is legible.

Hose I.D.	Schedule 80 Plated Carbon Steel	316 Stainless Steel
	Part #	Part #
1"	STC10CS	RST10CS
1-1/4"	STC15CS	RST15CS
1-1/2"	STC20CS	RST20CS
2"	STC25CS	RST25CS
2-1/2"	STC30CS	RST30CS
3"	STC35CS	RST35CS
4"	STC40CS	RST40CS
6"	STC60CS	RST60CS



NOTE: For 8" options see page 11.

### Grooved End

**Feature**

- There are two grooves on the crimp style King combination nipples. The second groove is the roll stamp groove, which has the part number and "call Dixon" stamped on it. This groove is a smooth concentric groove so that the stamp is legible.

Hose I.D.	Schedule 80 Plated Carbon Steel	316 Stainless Steel
	Part #	Part #
1"	STV10CS	RSTV10CS
1-1/2"	STV20CS	RSTV20CS
2"	STV25CS	RSTV25CS
2-1/2"	STV30CS	RSTV30CS
3"	STV35CS	RSTV35CS
4"	STV40CS	RSTV40CS
6"	STV60CS	RSTV60CS



### Beveled End

**Feature**

- There are two grooves on the crimp style King combination nipples. The second groove is the roll stamp groove, which has the part number and "call Dixon" stamped on it. This groove is a smooth concentric groove so that the stamp is legible.

Hose I.D.	Schedule 80 Carbon Steel	316 Stainless Steel
	Part #	Part #
1"	STB10CS	RSTB10CS
1-1/2"	STB20CS	RSTB20CS
2"	STB25CS	RSTB25CS
2-1/2"	STB30CS	RSTB30CS
3"	STB35CS	RSTB35CS
4"	STB40CS	RSTB40CS
6"	STB60CS	RSTB60CS



NOTE: For additional information on pipe dimensions please reference [dixonvalve.com](http://dixonvalve.com).

### FJIC

Hose I.D.	Ambient Working Pressures @ 70°F (21 °C)		Carbon Steel Part #
	Sleeve	Ferrule	
1"	400	400	SFJCT10CS
1-1/2"	300	350	SFJCT20CS
2"	250	300	SFJCT25CS

Only use the crimp style shanks with the crimp style sleeves and ferrules. Due to differences in dimensions and tolerances for safety reasons, do not interchange other manufacturers' products with Dixon products.



## King Crimp Style

### 150# ASA Fixed (Welded) Flanges



Only use the crimp style shanks with the crimp style sleeves and ferrules. Due to differences in dimensions and tolerances for safety reasons, do not interchange other manufacturers' products with Dixon® products.

#### Features

- There are two grooves on the crimp style King combination nipples. The second groove is the roll stamp groove, which has the part number and "call Dixon" stamped on it. This groove is a smooth concentric groove so that the stamp is legible.



stainless steel

Size	Steel Part #	316 Stainless Steel Part #
1-1/2"	FST20CS	RFST20CS
2"	FST25CS	RFST25CS
3"	FST35CS	RFST35CS
4"	FST40CS	RFST40CS
6"	FST60CS	RFST60CS

NOTE: For flange dimensions, diagrams, and additional information, please reference [dixonvalve.com](http://dixonvalve.com). For additional information on pipe dimensions, please reference [dixonvalve.com](http://dixonvalve.com).

### Combination Nipple x TTMA Flanges

#### Feature

- To be used with King Crimp sleeves and/or ferrules



carbon steel

Size	Flange Thickness	Carbon Steel Part #	Aluminum Part #
3"	1/4"	TTFST35CS	---
3"	3/8"	TTFST35CS-THK	---
4"	5/16"	TTFST40CS	ATTFST40CS
4"	3/8"	TTFST40CS-THK	---

NOTE: For flange dimensions, diagrams and additional information please reference [dixonvalve.com](http://dixonvalve.com). For additional information on pipe dimensions please reference [dixonvalve.com](http://dixonvalve.com).



aluminum

### Nipples for Floating Flanges

#### Feature

- To be used with King Crimp sleeves and/or ferrules



carbon steel

Size	Plated Carbon Steel Part #	316 Stainless Steel Part #
2"	N25CS	RN25CS
3"	N35CS	RN35CS
4"	N40CS	RN40CS
6"	N60CS	RN60CS

NOTE: To be used with LJ/LJR floating flanges on page 956.

## Dixon Sanitary King Crimp Stem

### Features

- To be used with King Crimp sleeves and/or ferrules see pages 13-16
- Wetted surfaces meet governmental and independent regulatory standards only

### Clamp End x Hose Shank Stems

Size	316 Stainless Steel Part #
1"	CSSR100CS
1-1/2"	CSSR150CS
2"	CSSR200CS
3"	CSSR300CS
4"	CSSR400CS

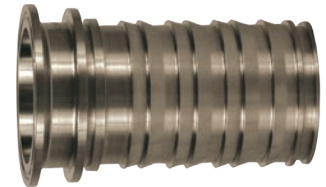

### Female I-line x Hose Shank Stems

Size	316 Stainless Steel Part #
1"	CILR100CS
1-1/2"	CILR150CS
2"	CILR200CS
3"	CILR300CS
4"	CILR400CS



## King Crimp Style

### Short Combination Nipples - Threaded End

Size	Schedule 40 Plated Carbon Steel Part #
8"	STC80CS



NOTE: For use with ferrules below

### Short Combination Nipples - Grooved End

Size	Schedule 40 Plated Carbon Steel Part #
8"	STV80CS



NOTE: For additional information on pipe dimensions please reference [dixonvalve.com](http://dixonvalve.com).

### Short Ferrules

Hose I.D.	Hose O.D.		Ferrule Wall Thickness	Ferrule I.D.	Ferrule Overall Length	Carbon Steel Part #
	From	To				
8"	8-29/64"	8-36/64"	.120"	8.625"	4.25"	CFS800-1CS
	8-37/64"	8-44/64"	.120"	8.750"	4.25"	CFS800-2CS
	8-45/64"	8-52/64"	.120"	8.875"	4.25"	CFS800-3CS
	8-53/64"	8-60/64"	.120"	9.000"	4.25"	CFS800-4CS
	8-61/64"	9-4/64"	.120"	9.125"	4.25"	CFS800-5CS
	9-5/64"	9-12/64"	.120"	9.250"	4.25"	CFS800-6CS
	9-13/64"	9-20/64"	.120"	9.375"	4.25"	CFS800-7CS
	9-21/64"	9-28/64"	.120"	9.500"	4.25"	CFS800-8CS



NOTE: Consult Dixon for additional ferrule sizes.

## King Crimp Style

### Combination Nipples - Heavy-Duty, Threaded End

#### Application

- Used in the fast-paced transfer of water, chemicals, and sand slurry to a hydraulic fracturing site



#### Features

- Water and petroleum transfer hoses rated from **100 to 300 PSI** WP (4:1 SF) have excellent test results with the standard King Crimp ferrules CF400-xxCS.
- **400 PSI** working pressure at **70°F (21°C)** when used with heavy-duty crimp ferrules (CF400-6CSHD through CF400-16CSHD)
- Used with ferrules below

Size	Description	Schedule 80 Steel Part#
4"	male NPT fitting	STC40CSHD

### Ferrules - Heavy-Duty

Only use the crimp style shanks with the crimp style sleeves and ferrules. Due to differences in dimensions and tolerances for safety reasons, do not interchange other manufacturers' products with Dixon® products.



#### Features

- **400 PSI** working pressure with a minimum 4:1 safety factor (hose burst: hose working pressure) is only achieved with heavy-duty (HD) crimp ferrules, CF400-6CSHD through CF400-16CSHD using heavy duty King Crimp stem STC40CSHD



Hose I.D.	Hose O.D.		Ferrule Wall Thickness	Ferrule I.D.	Ferrule Overall Length	Carbon Steel Part #
	From	To				
4"	4-33/64"	4-36/64"	0.120"	4.625"	4"	CF400-6CSHD
	4-37/64"	4-40/64"	0.120"	4.688"	4"	CF400-7CSHD
	4-41/64"	4-44/64"	0.120"	4.750"	4"	CF400-8CSHD
	4-45/64"	4-48/64"	0.120"	4.813"	4"	CF400-9CSHD
	4-49/64"	4-52/64"	0.120"	4.875"	4"	CF400-10CSHD
	4-53/64"	4-56/64"	0.120"	4.938"	4"	CF400-11CSHD
	4-57/64"	4-60/64"	0.120"	5.000"	4"	CF400-12CSHD
	4-61/64"	5"	0.120"	5.063"	4"	CF400-13CSHD
	5-1/64"	5-4/64"	0.120"	5.125"	4"	CF400-14CSHD
	5-5/64"	5-8/64"	0.120"	5.188"	4"	CF400-15CSHD
	5-9/64"	5-12/64"	0.120"	5.250"	4"	CF400-16CSHD

### King Crimp Style Ferrules

Only use the crimp style shanks with the crimp style sleeves and ferrules. Due to differences in dimensions and tolerances for safety reasons, do not interchange other manufacturers' products with Dixon® products.



**A**

Hose I.D.	Hose O.D.		Work. Pressure (PSI)		Ferrule I.D.	Ferrule Wall Thickness	Ferrule Overall Length	Carbon Steel Part #	304 Stainless Steel Part #
	From	To	cam & groove <sup>1</sup>	King Crimp nipple <sup>2</sup>					
1"	1-13/64"	1-16/64"	*	*	1.313"	.060"	2-13/16"	CF100-1CS	CF100-1SS
	1-17/64"	1-20/64"	*	*	1.375"	.060"	2-13/16"	CF100-2CS	CF100-2SS
	1-21/64"	1-24/64"	*	*	1.438"	.060"	2-13/16"	CF100-3CS	CF100-3SS
	1-25/64"	1-28/64"	*	*	1.500"	.060"	2-13/16"	CF100-4CS	CF100-4SS
	1-29/64"	1-32/64"	*	*	1.563"	.060"	2-13/16"	CF100-5CS	CF100-5SS
	1-33/64"	1-36/64"	*	*	1.625"	.060"	2-13/16"	CF100-6CS	CF100-6SS
	1-37/64"	1-40/64"	*	*	1.688"	.060"	2-13/16"	CF100-7CS	CF100-7SS
	1-41/64"	1-44/64"	*	*	1.750"	.060"	2-13/16"	CF100-8CS	CF100-8SS
	1-45/64"	1-48/64"	*	*	1.813"	.060"	2-13/16"	CF100-9CS	CF100-9SS
	1-49/64"	1-52/64"	*	*	1.875"	.060"	2-13/16"	CF100-10CS	CF100-10SS
1-1/4"	1-41/64"	1-44/64"	250	350	1.750"	.060"	2-13/16"	CF125-3CS	CF125-3SS
	1-45/64"	1-48/64"	250	350	1.813"	.060"	2-13/16"	CF125-4CS	CF125-4SS
	1-49/64"	1-52/64"	250	350	1.875"	.060"	2-13/16"	CF125-5CS	CF125-5SS
	1-53/64"	1-56/64"	250	350	1.938"	.060"	2-13/16"	CF125-6CS	CF125-6SS
1-1/2"	1-41/64"	1-44/64"	250	350	1.750"	.062"	2-13/16"	CF150-1CS	CF150-1SS
	1-45/64"	1-48/64"	250	350	1.813"	.060"	2-13/16"	CF150-2CS	CF150-2SS
	1-49/64"	1-52/64"	250	350	1.875"	.060"	2-13/16"	CF150-3CS	CF150-3SS
	1-53/64"	1-56/64"	250	350	1.938"	.060"	2-13/16"	CF150-4CS	CF150-4SS
	1-57/64"	1-60/64"	250	350	2.000"	.060"	2-13/16"	CF150-5CS	CF150-5SS
	1-61/64"	2"	250	350	2.063"	.060"	2-13/16"	CF150-6CS	CF150-6SS
	2-1/64"	2-4/64"	250	350	2.125"	.060"	2-13/16"	CF150-7CS	CF150-7SS
	2-5/64"	2-8/64"	250	350	2.188"	.060"	2-13/16"	CF150-8CS	CF150-8SS
	2-9/64"	2-12/64"	250	350	2.250"	.060"	2-13/16"	CF150-9CS	CF150-9SS
	2-13/64"	2-16/64"	250	350	2.313"	.060"	2-13/16"	CF150-10CS	CF150-10SS
2"	2-17/64"	2-20/64"	250	300	2.375"	.060"	3-1/8"	CF200-1CS	CF200-1SS
	2-21/64"	2-24/64"	250	300	2.438"	.060"	3-1/8"	CF200-2CS	CF200-2SS
	2-25/64"	2-28/64"	250	300	2.500"	.060"	3-1/8"	CF200-3CS	CF200-3SS
	2-29/64"	2-32/64"	250	300	2.563"	.060"	3-1/8"	CF200-4CS	CF200-4SS
	2-33/64"	2-36/64"	250	300	2.625"	.060"	3-1/8"	CF200-5CS	CF200-5SS
	2-37/64"	2-40/64"	250	300	2.688"	.060"	3-1/8"	CF200-6CS	CF200-6SS
	2-41/64"	2-44/64"	250	300	2.750"	.060"	3-1/8"	CF200-7CS	CF200-7SS
	2-45/64"	2-48/64"	250	300	2.813"	.060"	3-1/8"	CF200-8CS	CF200-8SS
	2-49/64"	2-52/64"	250	300	2.875"	.060"	3-1/8"	CF200-9CS	CF200-9SS
	2-53/64"	2-56/64"	250	300	2.938"	.060"	3-1/8"	CF200-10CS	CF200-10SS
	2-57/64"	2-60/64"	250	300	2.938"	.060"	3-1/8"	CF200-11CS	CF200-11SS
	2-57/64"	2-60/64"	250	300	3.000"	.060"	3-1/8"	CF200-12CS	CF200-12SS
2-1/2"	2-57/64"	2-60/64"	---	300	3.000"	.060"	3-1/2"	CF250-5CS	---
	2-61/64"	3"	---	300	3.063"	.060"	3-1/2"	CF250-6CS	---
	3-1/64"	3-4/64"	---	300	3.125"	.060"	3-1/2"	CF250-7CS	---
	3-5/64"	3-8/64"	---	300	3.188"	.060"	3-1/2"	CF250-8CS	---

\* Consult Dixon at [engineering@dixonvalve.com](mailto:engineering@dixonvalve.com) for pressure rating

<sup>1</sup> Based on using crimp cam and groove shanks

<sup>2</sup> Based on using King Crimp nipples



## King Crimp Style Ferrules

Only use the crimp style shanks with the crimp style sleeves and ferrules. Due to differences in dimensions and tolerances for safety reasons, do not interchange other manufacturers' products with Dixon® products.



Hose I.D.	Hose O.D.		Work. Pressure (PSI)		Ferrule I.D.	Ferrule Wall Thickness	Ferrule Overall Length	Carbon Steel Part #	304 Stainless Steel Part #
	From	To	cam & groove <sup>1</sup>	King Crimp nipple <sup>2</sup>					
3"	3-13/64"	3-16/64"	150	300	3.313"	.090"	4"	CF300-1CS	CF300-1SS
	3-17/64"	3-20/64"	150	300	3.375"	.090"	4"	CF300-2CS	CF300-2SS
	3-21/64"	3-24/64"	150	300	3.438"	.090"	4"	CF300-3CS	CF300-3SS
	3-25/64"	3-28/64"	150	300	3.500"	.090"	4"	CF300-4CS	CF300-4SS
	3-29/64"	3-32/64"	150	300	3.563"	.090"	4"	CF300-5CS	CF300-5SS
	3-33/64"	3-36/64"	150	300	3.625"	.090"	4"	CF300-6CS	CF300-6SS
	3-37/64"	3-40/64"	150	300	3.688"	.090"	4"	CF300-7CS	CF300-7SS
	3-41/64"	3-44/64"	150	300	3.750"	.090"	4"	CF300-8CS	CF300-8SS
	3-45/64"	3-48/64"	150	300	3.813"	.090"	4"	CF300-9CS	CF300-9SS
	3-49/64"	3-52/64"	150	300	3.875"	.090"	4"	CF300-10CS	CF300-10SS
	3-53/64"	3-56/64"	150	300	3.938"	.090"	4"	CF300-11CS	CF300-11SS
	3-57/64"	3-60/64"	150	300	4.000"	.090"	4"	CF300-12CS	CF300-12SS
	3-61/64"	4"	150	300	4.063"	.090"	4"	CF300-13CS	CF300-13SS
	4-1/64"	4-4/64"	150	300	4.125"	.090"	4"	CF300-14CS	CF300-14SS
	4-5/64"	4-8/64"	150	300	4.188"	.090"	4"	CF300-15CS	CF300-15SS
	4-9/64"	4-12/64"	150	300	4.250"	.090"	4"	CF300-16CS	CF300-16SS
4"	4-13/64"	4-16/64"	150	300	4.313"	.090"	4"	CF400-1CS	CF400-1SS
	4-17/64"	4-20/64"	150	300	4.375"	.090"	4"	CF400-2CS	CF400-2SS
	4-21/64"	4-24/64"	150	300	4.438"	.090"	4"	CF400-3CS	CF400-3SS
	4-25/64"	4-28/64"	150	300	4.500"	.090"	4"	CF400-4CS	CF400-4SS
	4-29/64"	4-32/64"	150	300	4.563"	.090"	4"	CF400-5CS	CF400-5SS
	4-33/64"	4-36/64"	150	300	4.625"	.090"	4"	CF400-6CS	CF400-6SS
	4-37/64"	4-40/64"	150	300	4.688"	.090"	4"	CF400-7CS	CF400-7SS
	4-41/64"	4-44/64"	150	300	4.750"	.090"	4"	CF400-8CS	CF400-8SS
	4-45/64"	4-48/64"	150	300	4.813"	.090"	4"	CF400-9CS	CF400-9SS
	4-49/64"	4-52/64"	150	300	4.875"	.090"	4"	CF400-10CS	CF400-10SS
	4-53/64"	4-56/64"	150	300	4.938"	.090"	4"	CF400-11CS	CF400-11SS
	4-57/64"	4-60/64"	150	300	5.000"	.090"	4"	CF400-12CS	CF400-12SS
	4-61/64"	5"	150	300	5.063"	.090"	4"	CF400-13CS	CF400-13SS
	5-1/64"	5-4/64"	150	300	5.125"	.090"	4"	CF400-14CS	CF400-14SS
	5-5/64"	5-8/64"	150	300	5.188"	.090"	4"	CF400-15CS	CF400-15SS
	5-9/64"	5-12/64"	150	300	5.250"	.090"	4"	CF400-16CS	CF400-16SS
6"	6-21/64"	6-28/64"	*	*	6.500"	.120"	5-7/8"	CF600-1CS	CF600-1SS
	6-29/64"	6-36/64"	*	*	6.625"	.120"	5-7/8"	CF600-2CS	CF600-2SS
	6-37/64"	6-44/64"	*	*	6.750"	.120"	5-7/8"	CF600-3CS	CF600-3SS
	6-45/64"	6-52/64"	*	*	6.875"	.120"	5-7/8"	CF600-4CS	CF600-4SS
	6-53/64"	6-60/64"	*	*	7.000"	.120"	5-7/8"	CF600-5CS	CF600-5SS
	6-61/64"	7-4/64"	*	*	7.125"	.120"	5-7/8"	CF600-6CS	CF600-6SS
	7-5/64"	7-12/64"	*	*	7.250"	.120"	5-7/8"	CF600-7CS	CF600-7SS
	7-13/64"	7-20/64"	*	*	7.375"	.120"	5-7/8"	CF600-8CS	CF600-8SS
	7-21/64"	7-28/64"	*	*	7.500"	.120"	5-7/8"	CF600-9CS	CF600-9SS

\* Consult Dixon at [engineering@dixonvalve.com](mailto:engineering@dixonvalve.com) for pressure rating

<sup>1</sup> Based on using crimp cam and groove shanks

<sup>2</sup> Based on using King Crimp nipples



### King Crimp Style Sleeves

- Only use the crimp style shanks with the crimp style sleeves and ferrules. Due to differences in dimensions and tolerances for safety reasons, do not interchange other manufacturers' products with Dixon® products.
- For liquid service only
- Not intended for steam service



Hose I.D.	Hose O.D.		Work. Pressure (PSI)		Sleeve I.D.	Sleeve Wall Thick.	Sleeve Overall Length	Carbon Steel Part #	304 Stainless Steel Part #	Aluminum Part #
	From	To	cam & groove <sup>1</sup>	King Crimp nipple <sup>2</sup>						
1"	1-13/64"	1-16/64"	*	*	1.313"	.060"	2-1/2"	CS100-1CS	CS100-1SS	---
	1-17/64"	1-20/64"	*	*	1.375"	.060"	2-1/2"	CS100-2CS	CS100-2SS	CS100-2AL
	1-21/64"	1-24/64"	*	*	1.438"	.060"	2-1/2"	CS100-3CS	CS100-3SS	---
	1-25/64"	1-28/64"	*	*	1.500"	.060"	2-1/2"	CS100-4CS	CS100-4SS	CS100-4AL
	1-29/64"	1-32/64"	*	*	1.563"	.060"	2-1/2"	CS100-5CS	CS100-5SS	---
	1-33/64"	1-36/64"	*	*	1.625"	.060"	2-1/2"	CS100-6CS	CS100-6SS	CS100-6AL
	1-37/64"	1-40/64"	*	*	1.688"	.060"	2-1/2"	CS100-7CS	CS100-7SS	---
	1-41/64"	1-44/64"	*	*	1.750"	.060"	2-1/2"	CS100-8CS	CS100-8SS	---
	1-45/64"	1-48/64"	*	*	1.813"	.060"	2-1/2"	CS100-9CS	CS100-9SS	---
	1-49/64"	1-52/64"	*	*	1.875"	.060"	2-1/2"	CS100-10CS	CS100-10SS	---
1-1/4"	1-41/64"	1-44/64"	250	300	1.750"	.060"	2-1/2"	CS125-3CS	CS125-3SS	---
	1-45/64"	1-48/64"	250	300	1.813"	.060"	2-1/2"	CS125-4CS	CS125-4SS	---
	1-49/64"	1-52/64"	250	300	1.875"	.060"	2-1/2"	CS125-5CS	CS125-5SS	---
	1-53/64"	1-56/64"	250	300	1.938"	.060"	2-1/2"	CS125-6CS	CS125-6SS	---
1-1/2"	1-41/64"	1-44/64"	250	300	1.750"	.060"	2-1/2"	CS150-1CS	CS150-1SS	---
	1-45/64"	1-48/64"	250	300	1.813"	.060"	2-1/2"	CS150-2CS	CS150-2SS	---
	1-49/64"	1-52/64"	250	300	1.875"	.060"	2-1/2"	CS150-3CS	CS150-3SS	CS150-3AL
	1-53/64"	1-56/64"	250	300	1.938"	.060"	2-1/2"	CS150-4CS	CS150-4SS	---
	1-57/64"	1-60/64"	250	300	2.000"	.060"	2-1/2"	CS150-5CS	CS150-5SS	---
	1-61/64"	2"	250	300	2.063"	.060"	2-1/2"	CS150-6CS	CS150-6SS	---
	2-1/64"	2-4/64"	250	300	2.125"	.060"	2-1/2"	CS150-7CS	CS150-7SS	CS150-7AL
	2-5/64"	2-8/64"	250	300	2.188"	.060"	2-1/2"	CS150-8CS	CS150-8SS	---
	2-9/64"	2-12/64"	250	300	2.250"	.060"	2-1/2"	CS150-9CS	CS150-9SS	---
	2-13/64"	2-16/64"	250	300	2.313"	.060"	2-1/2"	CS150-10CS	CS150-10SS	---
	2-17/64"	2-20/64"	250	300	2.375"	.060"	2-1/2"	CS150-11CS	CS150-11SS	---
	2-21/64"	2-24/64"	250	300	2.438"	.060"	2-1/2"	CS150-12CS	CS150-12SS	---
2"	2-13/64"	2-16/64"	250	250	2.313"	.060"	2-7/8"	CS200-1CS	CS200-1SS	---
	2-17/64"	2-20/64"	250	250	2.375"	.060"	2-7/8"	CS200-2CS	CS200-2SS	---
	2-21/64"	2-24/64"	250	250	2.438"	.060"	2-7/8"	CS200-3CS	CS200-3SS	---
	2-25/64"	2-28/64"	250	250	2.500"	.060"	2-7/8"	CS200-4CS	CS200-4SS	CS200-4AL
	2-29/64"	2-32/64"	250	250	2.563"	.060"	2-7/8"	CS200-5CS	CS200-5SS	CS200-5AL
	2-33/64"	2-36/64"	250	250	2.625"	.060"	2-7/8"	CS200-6CS	CS200-6SS	CS200-6AL
	2-37/64"	2-40/64"	250	250	2.688"	.060"	2-7/8"	CS200-7CS	CS200-7SS	---
	2-41/64"	2-44/64"	250	250	2.750"	.060"	2-7/8"	CS200-8CS	CS200-8SS	---
	2-45/64"	2-48/64"	250	250	2.813"	.060"	2-7/8"	CS200-9CS	CS200-9SS	---
	2-49/64"	2-52/64"	250	250	2.875"	.060"	2-7/8"	CS200-10CS	CS200-10SS	CS200-10AL
	2-53/64"	2-56/64"	250	250	2.938"	.060"	2-7/8"	CS200-11CS	CS200-11SS	CS200-11AL
	2-57/64"	2-60/64"	250	250	3.000"	.060"	2-7/8"	CS200-12CS	CS200-12SS	CS200-12AL
2-1/2"	2-57/64"	2-60/64"	---	*	3.000"	.060"	3-1/4"	CS250-5CS	---	---
	2-61/64"	3"	---	*	3.063"	.060"	3-1/4"	CS250-6CS	---	---
	3-1/64"	3-4/64"	---	*	3.125"	.060"	3-1/4"	CS250-7CS	---	---
	3-5/64"	3-8/64"	---	*	3.188"	.060"	3-1/4"	CS250-8CS	---	---

\* Consult Dixon at [engineering@dixonvalve.com](mailto:engineering@dixonvalve.com) for pressure rating

<sup>1</sup> Based on using crimp cam and groove shanks

<sup>2</sup> Based on using King Crimp nipples



### King Crimp Style Sleeves

- Only use the crimp style shanks with the crimp style sleeves and ferrules. Due to differences in dimensions and tolerances for safety reasons, do not interchange other manufacturers' products with Dixon® products.
- For liquid service only
- Not intended for steam service



Hose I.D.	Hose O.D.		Work. Pressure (PSI)		Sleeve I.D.	Sleeve Wall Thick.	Sleeve Overall Length	Carbon Steel Part #	304 Stainless Steel Part #	Aluminum Part #
	From	To	cam & groove <sup>1</sup>	King Crimp nipple <sup>2</sup>						
3"	3-13/64"	3-16/64"	125	200	3.313"	.090"	3-3/4"	CS300-1CS	CS300-1SS	---
	3-17/64"	3-20/64"	125	200	3.375"	.090"	3-3/4"	CS300-2CS	CS300-2SS	---
	3-21/64"	3-24/64"	125	200	3.438"	.090"	3-3/4"	CS300-3CS	CS300-3SS	---
	3-25/64"	3-28/64"	125	200	3.500"	.090"	3-3/4"	CS300-4CS	CS300-4SS	---
	3-29/64"	3-32/64"	125	200	3.563"	.090"	3-3/4"	CS300-5CS	CS300-5SS	CS300-5AL
	3-33/64"	3-36/64"	125	200	3.625"	.090"	3-3/4"	CS300-6CS	CS300-6SS	---
	3-37/64"	3-40/64"	125	200	3.688"	.090"	3-3/4"	CS300-7CS	CS300-7SS	CS300-7AL
	3-41/64"	3-44/64"	125	200	3.750"	.090"	3-3/4"	CS300-8CS	CS300-8SS	CS300-8AL
	3-45/64"	3-48/64"	125	200	3.813"	.090"	3-3/4"	CS300-9CS	CS300-9SS	---
	3-49/64"	3-52/64"	125	200	3.875"	.090"	3-3/4"	CS300-10CS	CS300-10SS	CS300-10AL
	3-53/64"	3-56/64"	125	200	3.938"	.090"	3-3/4"	CS300-11CS	CS300-11SS	---
	3-57/64"	3-60/64"	125	200	4.000"	.090"	3-3/4"	CS300-12CS	CS300-12SS	CS300-12AL
	3-61/64"	4"	125	200	4.063"	.090"	3-3/4"	CS300-13CS	CS300-13SS	---
	4-1/64"	4-4/64"	125	200	4.125"	.090"	3-3/4"	CS300-14CS	CS300-14SS	---
	4-5/64"	4-8/64"	125	200	4.188"	.090"	3-3/4"	CS300-15CS	CS300-15SS	---
	4-9/64"	4-12/64"	125	200	4.250"	.090"	3-3/4"	CS300-16CS	CS300-16SS	---
4"	4-13/64"	4-16/64"	110	175	4.313"	.090"	3-3/4"	CS400-1CS	CS400-1SS	---
	4-17/64"	4-20/64"	110	175	4.375"	.090"	3-3/4"	CS400-2CS	CS400-2SS	---
	4-21/64"	4-24/64"	110	175	4.438"	.090"	3-3/4"	CS400-3CS	CS400-3SS	---
	4-25/64"	4-28/64"	110	175	4.500"	.090"	3-3/4"	CS400-4CS	CS400-4SS	---
	4-29/64"	4-32/64"	110	175	4.563"	.090"	3-3/4"	CS400-5CS	CS400-5SS	---
	4-33/64"	4-36/64"	110	175	4.625"	.090"	3-3/4"	CS400-6CS	CS400-6SS	---
	4-37/64"	4-40/64"	110	175	4.688"	.090"	3-3/4"	CS400-7CS	CS400-7SS	---
	4-41/64"	4-44/64"	110	175	4.750"	.090"	3-3/4"	CS400-8CS	CS400-8SS	---
	4-45/64"	4-48/64"	110	175	4.813"	.090"	3-3/4"	CS400-9CS	CS400-9SS	---
	4-49/64"	4-52/64"	110	175	4.875"	.090"	3-3/4"	CS400-10CS	CS400-10SS	CS400-10AL
	4-53/64"	4-56/64"	110	175	4.938"	.090"	3-3/4"	CS400-11CS	CS400-11SS	CS400-11AL
	4-57/64"	4-60/64"	110	175	5.000"	.090"	3-3/4"	CS400-12CS	CS400-12SS	CS400-12AL
	4-61/64"	5"	110	175	5.063"	.090"	3-3/4"	CS400-13CS	CS400-13SS	---
	5-1/64"	5-4/64"	110	175	5.125"	.090"	3-3/4"	CS400-14CS	CS400-14SS	---
	5-5/64"	5-8/64"	110	175	5.188"	.090"	3-3/4"	CS400-15CS	CS400-15SS	---
	5-9/64"	5-12/64"	110	175	5.250"	.090"	3-3/4"	CS400-16CS	CS400-16SS	---
6"	6-21/64"	6-28/64"	*	*	6.500"	.120"	5-1/2"	CS600-1CS	CS600-1SS	---
	6-29/64"	6-36/64"	*	*	6.625"	.120"	5-1/2"	CS600-2CS	CS600-2SS	---
	6-37/64"	6-44/64"	*	*	6.750"	.120"	5-1/2"	CS600-3CS	CS600-3SS	---
	6-45/64"	6-52/64"	*	*	6.875"	.120"	5-1/2"	CS600-4CS	CS600-4SS	---
	6-53/64"	6-60/64"	*	*	7.000"	.120"	5-1/2"	CS600-5CS	CS600-5SS	---
	6-61/64"	7-4/64"	*	*	7.125"	.120"	5-1/2"	CS600-6CS	CS600-6SS	---
	7-5/64"	7-12/64"	*	*	7.250"	.120"	5-1/2"	CS600-7CS	CS600-7SS	---
	7-13/64"	7-20/64"	*	*	7.375"	.120"	5-1/2"	CS600-8CS	CS600-8SS	---
	7-21/64"	7-28/64"	*	*	7.500"	.120"	5-1/2"	CS600-9CS	CS600-9SS	---

\* Consult Dixon at [engineering@dixonvalve.com](mailto:engineering@dixonvalve.com) for pressure rating

<sup>1</sup> Based on using crimp cam and groove shanks

<sup>2</sup> Based on using King Crimp nipples

## King Crimp Style

## Large Sleeves

Hose I.D.	Sleeve I.D.	Sleeve Wall Thickness	Sleeve Overall Length	Carbon Steel Part #
6"	6.44"	0.120"	5.50"	S6438X550X120CS
	7.00"	0.120"	4.00"	S700X400X120CS
	7.00"	0.120"	6.00"	S700X600X120CS
8"	8.30"	0.120"	8.75"	S830X875X120CS
	8.38"	0.120"	6.00"	S838X600X120CS
	8.50"	0.120"	6.50"	S850X650X120CS
	8.75"	0.120"	6.00"	S875X600X120CS
	8.98"	0.120"	8.75"	S898X875X120CS
	9.00"	0.090"	4.00"	S900X400X090CS
	9.00"	0.120"	4.00"	S900X400X120CS
	9.00"	0.120"	6.00"	S900X600X120CS
	9.10"	0.120"	4.00"	S910X400X120CS
	9.12"	0.120"	6.00"	S912X600X120CS
	9.15"	0.120"	6.00"	S915X600X120CS
	9.25"	0.120"	4.00"	S925X400X120CS
	9.25"	0.120"	6.00"	S925X600X120CS
	9.50"	0.120"	4.00"	S950X400X120CS
	9.50"	0.120"	6.00"	S950X600X120CS
	9.75"	0.120"	6.00"	S975X600X120CS
	10"	10.25"	0.120"	7.50"
10.50"		0.120"	7.50"	S1050X750X120CS
11.00"		0.120"	6.00"	S1100X600X120CS
11.25"		0.120"	7.50"	S1125X750X120CS
11.75"		0.120"	6.00"	S1175X600X120CS
11.75"		0.120"	7.50"	S1175X750X120CS
12"	12.44"	0.120"	9.00"	S1244X900X120CS
	12.75"	0.120"	8.00"	S1275X800X120CS
	13.25"	0.120"	7.50"	S1325X750X120CS
	13.25"	0.120"	8.00"	S1325X800X120CS
	13.25"	0.120"	9.50"	S1325X950X120CS
	13.75"	0.120"	7.50"	S1375X750X120CS
14"	14.00"	0.120"	8.00"	S1400X800X120CS
	14.00"	0.120"	9.50"	S1400x950X120CS



NOTE: Consult Dixon® for additional sleeve sizes

**Cam & Groove Information ..... 20 - 23**

**B Venting EZ Boss-Lock ..... 24**

Type B ..... 24  
 Type C ..... 24  
 Type D ..... 24  
 Type H ..... 24

**Swivel Couplings ..... 25**

Type A ..... 25  
 Type C ..... 25  
 Type D ..... 25  
 Type E ..... 25

**King Crimp® System ..... 26**

**EZLink® Armless ..... 27 - 28**

Type B ..... 27  
 Type C ..... 27  
 Type D ..... 27  
 Type DC ..... 28  
 Replacement parts ..... 28  
 Safety clip ..... 28  
 Bottle opener ..... 28

**Vent-Lock® Safety ..... 29 - 31**

Type A ..... 29  
 Type C ..... 29  
 Type D ..... 30  
 Type E ..... 30  
 Type DC, DP and H ..... 30  
 Accessories ..... 31

**Type A Adapters ..... 32**

Dixon® ..... 32  
 with abrasion resistant inserts ..... 32

**Type B Couplers ..... 33 - 34**

Dixon ..... 33  
 Boss-Lock ..... 34  
 EZ Boss-Lock ..... 34

**Type C Couplers ..... 35 - 39**

Dixon ..... 35  
 with abrasion resistant inserts ..... 35  
 Dixon notched NOS ..... 36  
 Boss-Lock ..... 36  
 EZ Boss-Lock with collar ..... 37  
 Boss-Lock notched ..... 37

**Type C Couplers (Cont.) ..... 35 - 39**

EZ Boss-Lock ..... 38  
 EZ Boss-Lock phono finish ..... 38  
 EZ Boss-Lock with swaged ferrule ..... 39  
 EZ Boss-Lock notched ..... 39

**Type D Couplers ..... 40 - 42**

Dixon ..... 40  
 Boss-Lock ..... 41  
 EZ Boss-Lock ..... 42

**Type E Adapters ..... 43 - 45**

Dixon ..... 43  
 Dixon phono finish ..... 43  
 Dixon with swaged ferrule ..... 44  
 Notched shank ..... 44  
 Notched ferrules ..... 44  
 Notched NOS shank ..... 45  
 Notched NOS ferrules ..... 45

**Type F Adapters ..... 46**

Dixon ..... 46

**Dust Caps and Plugs ..... 47 - 50**

Type DC ..... 47  
 Dixon lockable caps ..... 48  
 Type H ..... 48, 49  
 Type DP ..... 50

**Hastelloy® ..... 51 - 52**

Type A ..... 51  
 Type E ..... 51  
 Type F ..... 51  
 EZ Boss-Lock Type B ..... 52  
 EZ Boss-Lock Type C ..... 52  
 EZ Boss-Lock Type D ..... 52

**Jump Size Couplers and Adapters ..... 53 - 57**

Dixon type DA with port ..... 53  
 Dixon type DA ..... 53  
 Boss-Lock type DA ..... 54  
 EZ Boss-Lock type DA ..... 54  
 Dixon type DA with port ..... 54  
 Dixon type AA spool adapters ..... 55  
 Dixon type DD couplers ..... 55  
 Boss-Lock type DD couplers ..... 55  
 Type A ..... 56  
 Type B ..... 56  
 Type C ..... 56

<b>Jump Size Couplers and Adapters (Cont.).....</b>	<b>53 - 57</b>	<b>Global (Cont.).....</b>	<b>75 - 84</b>
EZ Boss-Lock Type C .....	56	Dust caps and plugs .....	80
Type D .....	57	Jump size .....	81 - 82
Type E .....	57	Type DA .....	81
Type F .....	57	Type AA .....	81
		Type DD .....	81
		Type A .....	82
		Type C .....	82
		Type E.....	82
		TTMA flange .....	82
		Coupler and adapter x ANSI flange.....	83
		Accessories .....	83
		BSP Thread.....	84
		Type A .....	84
		Type B .....	84
		Type D .....	84
		Type F.....	84
<b>Elbows .....</b>	<b>58 - 60</b>	<b>NST Adapters.....</b>	<b>85</b>
45° .....	58	Type A .....	85
90° .....	58 - 60	Type B .....	85
15° .....	60	Type D .....	85
		Type F .....	85
<b>Flanged.....</b>	<b>61</b>	<b>Polypropylene .....</b>	<b>86 - 90</b>
Adapter x ANSI flange.....	61	Type A .....	86
Dixon .....	61	Type B .....	86
EZ Boss-Lock.....	61	Type C .....	87
		Type D .....	87
		Type E .....	88
		Type F .....	88
		Dust caps and plugs .....	89
		90° adapter x female NPT .....	90
		90° coupler x hose shank .....	90
		90° coupler x female NPT .....	90
		90° adapter x male NPT .....	90
<b>Weld End.....</b>	<b>62 - 63</b>		
Dixon couplers.....	62		
EZ Boss-Lock couplers .....	62 - 63		
Adapters .....	63		
<b>NPSM and Wye.....</b>	<b>64</b>		
<b>Hydrant Adapter .....</b>	<b>64</b>		
<b>Boss-Lock Coupler x Tube .....</b>	<b>65</b>		
<b>In-Line Sight Glasses .....</b>	<b>65</b>		
<b>Accessories .....</b>	<b>66 - 74</b>		
Handles.....	66 - 67		
Gaskets.....	68 - 71		
Strainers .....	72		
Pull rings.....	72		
Abrasion resistant inserts .....	73		
Clips .....	73		
Jack chain with S-hook.....	73		
Velcro® straps.....	73		
Lanyards .....	74		
<b>Global .....</b>	<b>75 - 84</b>		
Type A .....	75		
Type B .....	76		
Type C .....	77		
Type D .....	78		
Type E .....	79		
Type F .....	79		

**B**

### Ordering System

B

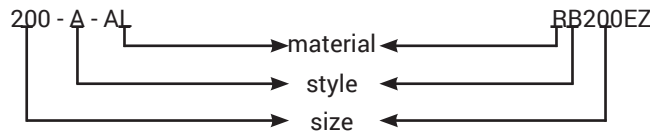

Size represents the coupler or adapter and hose or pipe end (i.e. 200 = 2"). If the coupling is a jump size, the coupler or adapter is the first size (i.e. 4030-C is 4" coupler to 3" hose shank).

### Operation of Cam & Groove

1. To make connection, slide the adapter into the coupler and, with normal hand pressure, press the cam levers down.
2. Uncoupling is as quick and simple as coupling. Just lift the cam arms and remove the adapter.

### Specifications on Dixon® Cam & Groove

#### Specifications

- Dixon, Boss-Lock, and EZ Boss-Lock cam & groove couplers and adapters are produced to interchange with all product produced to Commercial Item Description A-A-59326D.
- No standard exists for the 1/2", 5", and 8" fittings, and generally these sizes do not interchange with other manufacturers' products.
- Dust caps and dust plugs are **not** to be used in pressure applications for safety and environmental reasons.
- *Designed for use with liquids*; consult Dixon for specific recommendations.

#### Pressure Ratings

Recommendations based on the use of mating Dixon fittings at ambient temperature **70°F (21°C)** with standard nitrile rubber seal installed. For use at elevated temperature or other unusual operating conditions, consult Dixon. Dixon, Boss-Lock, and EZ Boss-Lock couplers' and adapters' maximum working pressures are as follows:



Size	1/2"	3/4" thru 2"	2-1/2"	3"	4"	5" and 6"	8"
PSI	150	250	150	125	100	75	50
PSI (working pressure with King Crimp® ferrule system)	150	250	150	150	150	75	50

### Cam & Groove Nominal Take-Up Lengths

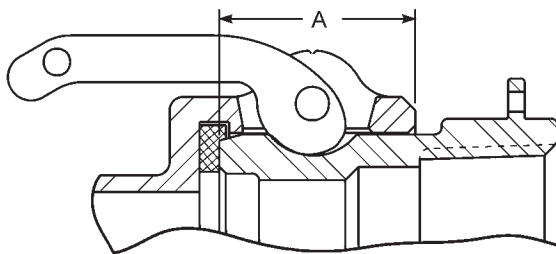

Coupling Size	Dimension A
1/2"	0.97"
3/4"	0.97"
1"	1.20"
1-1/4"	1.44"
1-1/2"	1.50"
2"	1.81"
2-1/2"	1.82"
3"	1.78"
4"	1.84"
5"	2.00"
6"	2.13"
8"	2.06"
8"	3.22"

## Cam & Groove Configurations

Configurations are representative of the Dixon® line of cam & groove.

**B**



**Type A**  
adapter x female NPT



**Type E**  
adapter x hose shank

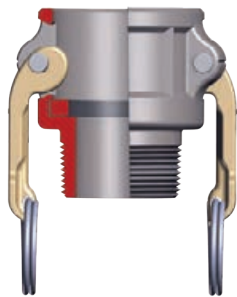

**Type B**  
coupler x male NPT

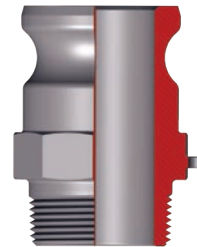

**Type F**  
adapter x male NPT

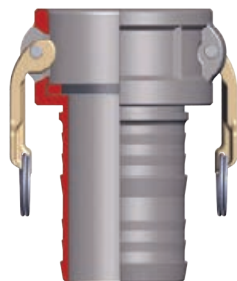

**Type C**  
coupler x hose shank

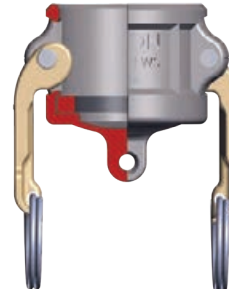

**Type DC<sup>1</sup>**  
dust cap

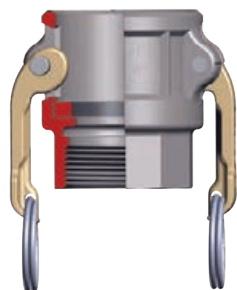

**Type D**  
coupler x female NPT



**Type DP<sup>1</sup>**  
dust plug



<sup>1</sup> Dust caps and dust plugs are not to be used in pressure applications for safety and environmental reasons.

### **⚠ WARNING**

Under no circumstances should cam & groove couplings be used for compressed air or steam service!

Dixon® Cam & Groove Styles

B



Dixon

Features

- Precision machined to rigid tolerances
- Durable stainless steel cam arm pins will not rust or bind, providing greater strength and safety
- Recess holds gasket firmly in place - ensures proper placement
- Long shank design allows proper banding, thus eliminating the major cause of hose damage



Dixon Global

Features

- Interchanges with all products produced to A-A-59326D
- All couplers include locking safety clip
- Aluminum couplers available with brass or stainless steel cam arms
- Brass fittings are produced by forging process providing greater structural integrity and mechanical strength



Boss-Lock

Features

- The cast-in lugs allow safety clips to be attached once the lugs are passed through slots in the special cam lever arms, providing a patented safety feature. The clips prevent the coupler from being unlocked until they are removed, providing a *positive locking action*.
- Boss-Lock investment stainless steel cam arms are guaranteed! Should you break a Boss-Lock investment stainless steel cam arm, return it to the nearest warehouse for a free replacement.
- The pull ring safety clip simplifies the locking action on Boss-Lock couplers. No more inserting clips or dangling lanyards, just a twist and it's locked, giving you a low-profile positive locking action.



EZ Boss-Lock

Features

- No more fumbling with clamps, wire, clips, or pins, just close the handles and the locking mechanism is engaged
- Extremely easy to open, the release lever is under your thumb when you want to open the fitting; ergonomic
- Can be supplied with custom shanks; also available with swaged and PF shanks for hard-to-couple chemical hoses
- EZ Boss-Lock investment stainless steel cam arms are guaranteed! Should you break one, return it to the nearest warehouse for a free replacement.



## Dixon® Cam & Groove Styles

### Vent-Lock® Safety

#### Features

- Safety release cam & groove couplings permit the release of static pressure when disconnecting hose assemblies
- Venting system protects operator from being sprayed with hazardous or non-hazardous fluids or solids
- Does not interchange with standard cam & groove products; use only with Vent-Lock L-style fittings 



### Venting EZ Boss-Lock

#### Features

- Unique Dixon system for safely venting systems under pressure
- Utilizes EZ Boss-Lock cam arms in addition to EZLink® tabs that create a secondary positive locking mechanism
- Connects to standard cam & groove adapters
- Design allows for a more ergonomic and safe experience for user

New



### EZLink® Armless

#### Features

- Automatic couplers push-to-connect, providing a reliable connection
- Coupler tabs cannot be pushed to disconnect when pressurized to **20 PSI** or over
- Low profile allows easy connection and disconnection in tight applications
- Coupler push tabs can be locked with safety pins and/or zip tie



B



## Venting EZ Boss-Lock Cam & Groove

### Application

- Transfer of fluids and solids, with a safe disconnection

### Sizes

- 2", 3", and 4"

### Features

- In the event of an accidental disconnection under pressure, the venting feature retains the coupling and allows the stored pressure to vent off
- Provides a venting feature when used with standard cam adapters
- The safety venting feature of this coupling doesn't require a special adapter to work as a system

### Materials

- 316 stainless steel
- 356T6 aluminum



**Type B Coupler**  
Coupler x Male NPT

Size	Aluminum Part #	316 Stainless Steel Part #
2"	ALBEZ200	RLBEZ200
3"	ALBEZ300	RLBEZ300
4"	ALBEZ400	RLBEZ400



**Type C Coupler**  
Coupler x Hose Shank

Size	Aluminum Part #	316 Stainless Steel Part #
2"	ALCEZ200 <sup>1</sup>	RLCEZ200 <sup>1</sup>
3"	ALCEZ300 <sup>1</sup>	RLCEZ300 <sup>1</sup>
4"	ALCEZ400 <sup>1</sup>	RLCEZ400 <sup>1</sup>

<sup>1</sup> Hose drop shank



**Type D Coupler**  
Coupler x Female NPT

Size	Aluminum Part #	316 Stainless Steel Part #
2"	ALDEZ200	RLDEZ200
3"	ALDEZ300	RLDEZ300
4"	ALDEZ400	RLDEZ400

**Type H**  
Dust Cap



Size	Aluminum Part #	316 Stainless Steel Part #
2"	ALHEZ200	RLHEZ200
3"	ALHEZ300	RLHEZ300
4"	ALHEZ400	RLHEZ400

## Swivel Couplings Cam &amp; Groove

New

B

## Features

- Live swivel is capable of 360-degree rotation under pressure
- Nitrile rubber X-ring seal for reduced friction and high stability in dynamic applications
- Couplers include EZ Boss-Lock cam arms

## Material

- Gasket: nitrile rubber

**Type A Adapters**  
**Adapter x Female NPT**

Size	Aluminum Part #	316 Stainless Steel Part #
2"	200-A-ALSWIV	200-A-SSSWIV
3"	300-A-ALSWIV	300-A-SSSWIV
4"	400-A-ALSWIV	400-A-SSSWIV

**Type C Coupler**  
**Coupler x Hose Shank**

Size	Aluminum Part #	316 Stainless Steel Part #
2"	AC200EZWIV	RC200EZWIV
3"	AC300EZWIV	RC300EZWIV
4"	AC400EZWIV	RC400EZWIV

**Type D Coupler**  
**Coupler x Female NPT**

Size	Aluminum Part #	316 Stainless Steel Part #
2"	AD200EZWIV	RD200EZWIV
3"	AD300EZWIV	RD300EZWIV
4"	AD400EZWIV	RD400EZWIV

**Type E Adapter**  
**Adapter x Hose Shank**

Size	Aluminum Part #	316 Stainless Steel Part #
2"	200-E-ALSWIV	200-E-SSSWIV
3"	300-E-ALSWIV	300-E-SSSWIV
4"	400-E-ALSWIV	400-E-SSSWIV



NOTE: Hose shanks are suitable for use with King Crimp sleeves and ferrules; see pages 13 - 16.

**King Crimp® System Cam & Groove**

**B**



Dixon® Type C domestic coupler



EZ Boss-Lock Type C domestic coupler



Type C global coupler



Dixon Type E domestic adapter



Type E global adapter

- For a complete listing of King Crimp system products, including cam & groove fittings, please reference pages 5 - 17.

**Crimp Working Pressure Chart**

Size	Temperature	Fitting	Clamp	Dixon Crimp (PSI)
1"	Ambient	100-C/E	sleeve	250
	160°F (71°C)	100-C/E	sleeve	242
	180°F (82°C)	100-C/E	sleeve	240
	250°F (121°C)	100-C/E	sleeve	200
	Ambient	100-C/E	ferrule	250
	160°F (71°C)	100-C/E	ferrule	242
	180°F (82°C)	100-C/E	ferrule	240
	250°F (121°C)	100-C/E	ferrule	200
1-1/2"	Ambient	150-C/E	sleeve	250
	160°F (71°C)	150-C/E	sleeve	200
	180°F (82°C)	150-C/E	sleeve	100
	250°F (121°C)	150-C/E	sleeve	75
	Ambient	150-C/E	ferrule	250
	160°F (71°C)	150-C/E	ferrule	200
	180°F (82°C)	150-C/E	ferrule	150
	250°F (121°C)	150-C/E	ferrule	100
2"	Ambient	200-C/E	sleeve	250
	160°F (71°C)	200-C/E	sleeve	100
	180°F (82°C)	200-C/E	sleeve	50
	250°F (121°C)	200-C/E	sleeve	50
	Ambient	200-C/E	ferrule	250
	160°F (71°C)	200-C/E	ferrule	100
	180°F (82°C)	200-C/E	ferrule	100
	250°F (121°C)	200-C/E	ferrule	100

Size	Temperature	Fitting	Clamp	Dixon Crimp (PSI)
3"	Ambient	300-C/E	sleeve	125
	160°F (71°C)	300-C/E	sleeve	100
	180°F (82°C)	300-C/E	sleeve	60
	250°F (121°C)	300-C/E	sleeve	55
	Ambient	300-C/E	ferrule	150
	160°F (71°C)	300-C/E	ferrule	125
	180°F (82°C)	300-C/E	ferrule	100
	250°F (121°C)	300-C/E	ferrule	75
4"	Ambient	400-C/E	sleeve	110
	160°F (71°C)	400-C/E	sleeve	75
	180°F (82°C)	400-C/E	sleeve	60
	250°F (121°C)	400-C/E	sleeve	50
	Ambient	400-C/E	ferrule	150
	160°F (71°C)	400-C/E	ferrule	75
	180°F (82°C)	400-C/E	ferrule	75
	250°F (121°C)	400-C/E	ferrule	75
6"	Ambient	600-C/E	sleeve	75
	160°F (71°C)	600-C/E	sleeve	*
	180°F (82°C)	600-C/E	sleeve	*
	250°F (121°C)	600-C/E	sleeve	*
	Ambient	600-C/E	ferrule	75
	160°F (71°C)	600-C/E	ferrule	*
	180°F (82°C)	600-C/E	ferrule	*
	250°F (121°C)	600-C/E	ferrule	*

\* Consult Dixon for PSI ratings

## EZLink® Armless Cam & Groove

### Applications

- Transfer and/or unloading of fuels (gasoline or diesel) from tank truck to storage tanks
- Transfer of liquids compatible with the available coupling and gasket materials

### Features

- Automatic couplers push-to-connect, providing a reliable connection
- Low profile allows easy connection and disconnection in tight applications
- Coupler push tabs can be locked with safety pins and/or zip tie
- Compatible with standard cam & groove adapters
- Lifetime warranty on stainless steel tabs

### Materials

- Couplings and dust caps: A356 aluminum, 316 stainless steel
- Coupler tabs and springs: 316 stainless steel
- Gasket: nitrile rubber

### Specifications

- Maximum working pressure with King Crimp® ferrules: 2" **250 PSI**, 3" and 4" **150 PSI**
- Maximum working pressure with crimp sleeves: 2" **250 PSI**, 3" **125 PSI**, 4" **110 PSI**
- Maximum working pressure with band clamps: 2" **250 PSI**, 3" **125 PSI**, 4" **100 PSI**
- Gasket temperature range: **5°F to 180°F (-15°C to 82°C)**

Only use EZLink gaskets and tabs for this coupling system. Traditional cam & groove handles and gaskets, or other types of seals, are not compatible and will fail.



### Type B Couplers Coupler x Male NPT

Size	A356 Aluminum Part #	316 Stainless Steel Part #
1-1/2"	EZL150-B-AL	EZL150-B-SS
2"	EZL200-B-AL	EZL200-B-SS
3"	EZL300-B-AL	EZL300-B-SS
4"	EZL400-B-AL	---



### Type C Couplers - King Crimp Hose Shank Coupler x Hose Shank

Size	A356 Aluminum Part #	316 Stainless Steel Part #
1-1/2"	EZL150-C-AL	EZL150-C-SS
2"	EZL200-C-AL	EZL200-C-SS
3"	EZL300-C-AL	EZL300-C-SS
4"	EZL400-C-AL	---



### Type D Couplers Coupler x Female NPT

Size	A356 Aluminum Part #	316 Stainless Steel Part #
1-1/2"	EZL150-D-AL	EZL150-D-SS
2"	EZL200-D-AL	EZL200-D-SS
3"	EZL300-D-AL	EZL300-D-SS
4"	EZL400-D-AL	---



**EZLink® Armless Cam & Groove**

**Type DC Dust Caps**

**B**



Size	A356 Aluminum Part #	316 Stainless Steel Part #
1-1/2"	EZL150-DC-AL	EZL150-DC-SS
2"	EZL200-DC-AL	EZL200-DC-SS
3"	EZL300-DC-AL	EZL300-DC-SS
4"	EZL400-DC-AL	---

**Replacement Kits**

**Feature**

- Kit contains: 2 pins, 2 springs, and 2 tabs



Size	Part #
1-1/2 and 2"	EZL200RPLKIT
3" and 4"	EZL300RPLKIT

**Replacement Gaskets**



Size	Nitrile Rubber Part #	Fluorosilicone Part #	FKM-A Part #
1-1/2"	EZL150-G-BU	EZL150-G-FV	EZL150-G-VI
2"	EZL200-G-BU	EZL200-G-FV	EZL200-G-VI
3"	EZL300-G-BU	EZL300-G-FV	EZL300-G-VI
4"	EZL400-G-BU	EZL400-G-FV	EZL400-G-VI

**Safety Clip**



Plated Carbon Steel Part #
EZLCL400

**Bottle Opener**



Brass Part #
CAMOPENER

## Vent-Lock® Safety Cam & Groove Couplings

### Application

- Transfer of fluids and solids, with a safer disconnection

### Features

- Safety release cam & groove couplings permit the release of static pressure when disconnecting hose assemblies
- Venting system protects operator from being sprayed with hazardous or non-hazardous fluids or solids
- Does not interchange with standard cam & groove products; use only with Dixon L-style fittings
- Safety orange cam arms
- Consult Dixon for availability of other materials

### Specifications

- Rated to **250 PSI**; recommendation based on the use of mating Dixon® L-style fittings at ambient temperature **70°F (21°C)** with standard nitrile rubber seal installed. For use at elevated temperature or other unusual operating conditions, consult Dixon
- 1", 1-1/2" and 2" sizes have a maximum working pressure of **250 PSI**
- 3" maximum working pressure **150 PSI** with King Crimp® ferrules, crimp sleeves, and bands at **125 PSI**
- 4" maximum working pressure **150 PSI** with King Crimp ferrules, crimp sleeves, and bands at **100 PSI**



### Attachment Options

- Ferrules, sleeves, bands, and other reliable options

#### Type A Adapters Adapter x Female NPT

Size	316 Stainless Steel Part #	Aluminum Part #
1"	L100-A-SS	---
1-1/2"	L150-A-SS	---
2"	L200-A-SS	---
3"	L300-A-SS	---
4"	---	L400-A-AL

#### Type C Couplers Coupler x Hose Shank

Size	316 Stainless Steel Part #
1"	L100-C-SS
1-1/2"	L150-C-SS
2"	L200-C-SS

#### EZ Boss-Lock Type C Couplers Coupler x Hose Shank

Size	316 Stainless Steel Part #	Aluminum Part #
1"	RLC100EZ	---
1-1/2"	RLC150EZ	---
2"	RLC200EZ <sup>1</sup>	---
3"	RLC300EZ <sup>1</sup>	---
4"	---	ALC400EZ <sup>1</sup>

<sup>1</sup> Has drop shank



**B**

**Vent-Lock® Safety Cam & Groove Couplings**

**Type D Couplers  
Coupler x Female NPT**



Size	316 Stainless Steel Part #
1"	RLD100EZ
1-1/2"	RLD150EZ
2"	RLD200EZ
3"	RLD300EZ

**Type E Adapters  
Adapter x Hose Shank**



Size	316 Stainless Steel Part #
1"	L100-E-SS
1-1/2"	L150-E-SS
2"	L200-E-SS
3"	L300-E-SS

**Type DC Dust Caps**



Size	316 Stainless Steel Part #
1"	L100-DC-SS
1-1/2"	L150-DC-SS
2"	L200-DC-SS

**Type DP Dust Plugs**



Size	316 Stainless Steel Part #
1"	L100-DP-SS
1-1/2"	L150-DP-SS
2"	L200-DP-SS
3"	L300-DP-SS

**EZ Boss-Lock Type H Dust Caps**



Size	316 Stainless Steel Part #	Aluminum Part #
1"	RLH100EZ	---
1-1/2"	RLH150EZ	---
2"	RLH200EZ	---
3"	RLH300EZ	---
3"	---	ALH400EZ



## Vent-Lock® Safety Cam & Groove Couplings Accessories

### Dixon® handle assembly

**Features**

- Use only with Dixon Vent-Lock couplers
- Includes handle, ring, and pin



**B**

Size	316 Stainless Steel Part #
1"	L100-HSCRPSI
1-1/2" - 2"	L200-HSCRPSI

### EZ Boss-Lock handle assembly

**Features**

- Use only with EZ Boss-Lock Vent-Lock couplers
- Includes handle, ring, and pin

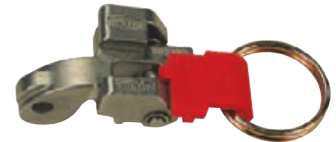

Size	316 Stainless Steel Part #
1"	LRHEZ175
1-1/2" - 2"	LRHEZ152
3"	LRHEZ34

B



356T6 aluminum



aluminum hardcoat



brass



unplated malleable iron



plated malleable iron



316 stainless steel



400-A-ALINSERT

## Dixon® Type A Adapters

### Adapter x Female NPT

#### Feature

- Pressure rating is based on the seal of the mating part, see ratings on page 20

Size	356T6 Aluminum Part #	Aluminum Hard Coat Part #	Brass Part #
1/2"	50-A-AL <sup>2</sup>	---	50-A-BR
3/4" x 1/2"	7550-A-AL <sup>2</sup>	---	7550-A-BR
3/4"	75-A-AL <sup>2</sup>	---	75-A-BR
1"	100-A-AL <sup>2</sup>	---	100-A-BR
1-1/4"	125-A-AL	---	125-A-BR
1-1/2"	150-A-AL	150-A-ALH	150-A-BR
2"	200-A-AL	200-A-ALH	200-A-BR
2-1/2"	250-A-AL	---	250-A-BR
3"	300-A-AL	300-A-ALH	300-A-BR
4"	400-A-AL	400-A-ALH	400-A-BR
5"	500-A-AL	---	500-A-BR
6"	600-A-AL	600-A-ALH	600-A-BR
8" DIX	800-A-AL <sup>1</sup>	---	---
8" BL	801-A-AL <sup>1</sup>	---	---

<sup>1</sup> Dixon and Boss-Lock cam & groove couplings *do not interchange in the 8" size*

<sup>2</sup> Made from 6061-T6 aluminum



Size	Unplated Malleable Iron Part #	Plated Malleable Iron Part #	316 Stainless Steel Part #
1/2"	---	---	50-A-SS
3/4" x 1/2"	---	---	7550-A-SS
3/4"	---	75-A-PM	75-A-SS
1"	---	100-A-PM	100-A-SS
1-1/4"	---	---	125-A-SS
1-1/2"	150-A-MI	150-A-PM	150-A-SS
2"	200-A-MI	200-A-PM	200-A-SS
2-1/2"	---	---	250-A-SS
3"	300-A-MI	300-A-PM	300-A-SS
4"	400-A-MI	400-A-PM	400-A-SS
5"	500-A-MI	---	500-A-SS
6"	---	600-A-PM <sup>1</sup>	600-A-SS

<sup>1</sup> Ductile iron

### Adapter x Female NPT with Abrasion Resistant Inserts

#### Features

- Used in extreme abrasion transfer applications such as sand transfer in hydraulic fracturing
- Replacement inserts are available on page 73

Description	UHMW Polyethylene Insert Part #
(400-A-AL) aluminum adapter x female NPT with UHMW insert	400-A-ALINSERT
(400-A-MI) malleable iron adapter x female NPT with UHMW insert	400-A-MIINSERT
(400-A-SS) stainless steel adapter x female NPT with UHMW insert	400-A-SSINSERT

## Dixon® Type B Couplers Coupler x Male NPT

**Features**

- Couplers are supplied standard with a nitrile rubber gasket, other gasket types are available on pages 68 - 71
- 1/2" Dixon coupler has only one cam arm
- Pull rings are not supplied on 1/2" - 1" Dixon couplings

Size	356T6 Aluminum Part #	Aluminum Hard Coat Part #	Brass Part #
1/2"	50-B-AL	---	50-B-BR
3/4"	75-B-AL	---	75-B-BR
1"	100-B-AL	---	100-B-BR
1-1/4"	125-B-AL	---	---
1-1/2"	150-B-AL	150-B-ALH	150-B-BR
2"	200-B-AL	200-B-ALH	200-B-BR
2-1/2"	250-B-AL	---	---
3"	300-B-AL	300-B-ALH	300-B-BR
4"	400-B-AL	400-B-ALH	400-B-BR
5"	500-B-AL	---	---
6"	600-B-AL	600-B-ALH	---
8"	800-B-AL <sup>1,2</sup>	---	---

<sup>1</sup> Dixon and Boss-Lock cam & groove couplings do not interchange in the 8" size  
The 8" Dixon design has 4 cam arms

<sup>2</sup> Parts are produced as a welded fabrication.

Size	Unplated Malleable Iron Part #	316 Stainless Steel Part #
1/2"	---	50-B-SS
3/4"	---	75-B-SS
1"	---	100-B-SS
1-1/2"	150-B-MI <sup>1</sup>	150-B-SS
2"	200-B-MI	200-B-SS
2-1/2"	---	250-B-SS
3"	300-B-MI <sup>1</sup>	300-B-SS
4"	400-B-MI	400-B-SS
6"	---	600-B-SS

<sup>1</sup> Ductile iron



356T6 aluminum



aluminum hard coat



brass



unplated malleable iron



316 stainless steel

B

B



356T6 aluminum



brass



plated malleable iron



316 stainless steel

### Boss-Lock Type B Couplers

Coupler x Male NPT

**Features**

- Couplers are supplied standard with a nitrile rubber gasket, other gasket types are available on pages 68 - 71
- All Boss-Lock couplers are supplied with pull-ring safety clips.

Size	356T6 Aluminum Part #	Brass Part #
3/4"	---	BB075
1"	AB100	BB100
1-1/4"	AB125	BB125
1-1/2"	AB150	BB150
2"	AB200	BB200
2-1/2"	AB250	BB250
3"	AB300	BB300
4"	AB400	BB400
6"	AB600	---

Size	Plated Malleable Iron Part #	316 Stainless Steel Part #
3/4" x 1/2"	---	RB050BL
3/4"	---	RB075BL
1"	IB100	RB100BL
1-1/4"	---	RB125BL
1-1/2"	---	RB150BL
2"	IB200	RB200BL
3"	---	RB300BL
4"	---	RB400BL

### EZ Boss-Lock Type B Couplers

Coupler x Male NPT

**Feature**

- Couplers are supplied standard with a nitrile rubber gasket, other gasket types are available on pages 68 - 71

Under no circumstances should the EZ Boss-Lock cam arms be used on any fitting not specifically designed for their use. See pages 20 - 23 for further specifications.



Size	356T6 Aluminum Part #	Brass Part #	316 Stainless Steel Part #
3/4" x 1/2"	---	---	RB050EZ
3/4"	---	BB075EZ	RB075EZ
1"	AB100EZ	BB100EZ	RB100EZ
1-1/4"	---	BB125EZ	RB125EZ
1-1/2"	AB150EZ	BB150EZ	RB150EZ
2"	AB200EZ	BB200EZ	RB200EZ
3"	AB300EZ	BB300EZ	RB300EZ
4"	AB400EZ	BB400EZ	RB400EZ
6"	---	---	RB600EZ



356T6 aluminum



brass



316 stainless steel

## Dixon® Type C Couplers Coupler x Hose Shank

**Features**

- Couplers are supplied standard with a nitrile rubber gasket, other gasket types are available on pages 68 - 71
- 1/2" Dixon coupler has only one cam arm
- Pull rings are not supplied on 1/2" - 1" Dixon couplings

Hose I.D.	356T6 Aluminum Part #	Aluminum Hard Coat Part #	Brass Part #
1/2"	50-C-AL	---	50-C-BR
3/4"	75-C-AL	---	75-C-BR
1"	100-C-AL	---	100-C-BR
1-1/4"	125-C-AL	---	125-C-BR
1-1/2"	150-C-AL	150-C-ALH	150-C-BR
2"	200-C-AL	200-C-ALH	200-C-BR
2-1/2"	250-C-AL	---	250-C-BR
3"	300-C-AL	300-C-ALH	300-C-BR
4"	400-C-AL	400-C-ALH	400-C-BR
5"	500-C-AL	---	---
6"	600-C-AL	600-C-ALH	600-C-BR
8"	800-C-AL <sup>1</sup>	---	---

Hose I.D.	Unplated Ductile Iron Part #	316 Stainless Steel Part #
1/2"	---	50-C-SS
3/4"	---	75-C-SS
1"	---	100-C-SS
1-1/4"	---	125-C-SS
1-1/2"	150-C-MI <sup>3</sup>	150-C-SS
2"	200-C-MI <sup>2</sup>	200-C-SS
2-1/2"	---	250-C-SS
3"	300-C-MI <sup>2</sup>	300-C-SS
4"	400-C-MI <sup>2</sup>	400-C-SS
5"	---	500-C-SS
6"	600-C-MI <sup>2</sup>	600-C-SS

<sup>1</sup> Dixon and Boss-Lock cam & groove couplings do not interchange in the 8" size the 8" Dixon design has 4 cam arms

<sup>2</sup> Suitable for use with King Crimp® sleeves and ferrules, see pages 13 - 16

<sup>3</sup> Malleable iron

Only use the crimp style shanks with the crimp style sleeves and ferrules. Due to differences in dimensions and tolerances for safety reasons, do not interchange other manufacturers' products with Dixon products.



### Coupler x Hose Shank with Abrasion Resistant Inserts

**Features**

- Used in extreme abrasion transfer applications such as sand transfer in hydraulic fracturing
- Replacement inserts are available on page 73

Description	UHMW Polyethylene Part #
(400-C-AL) aluminum coupler x hose shank with UHMW insert	400-C-ALINSERT
(400-C-MI) malleable iron coupler x hose shank with UHMW insert	400-C-MIINSERT



356T6 aluminum



aluminum hard coat



brass



unplated ductile iron



316 stainless steel



400-C-MIINSERT

B

**B**

## Dixon® Type C Couplers with Notched NOS Shank

### Coupler x NOS Shank

#### Features

- System allows you to better manage your inventories, you can stock one stem and two ferrules, and cover the same hose range with less inventory, you must purchase a fitting and the matching ferrule to create an assembly
- For hose outside diameters of 2-4/64" and below, the couplings are crimp only 
- For hose outside diameters of 2-5/64" and above, the couplings can be crimped or swaged
- For use with notched ferrules on page 44
- See page 363 for male NPT notched NOS fittings



Size	316 Stainless Steel Part #
1-1/2"	150CNOSSS <sup>1</sup>
2"	200CNOSSS
3"	300CNOSSS

<sup>1</sup> Part will be discontinued as stock is depleted

Only use the NOS shank with the NOS ferrules.

Due to differences in dimensions and tolerances for safety reasons, do not use other manufacturers' stems or ferrules with Dixon® products. 

## Boss-Lock Type C Couplers

### Coupler x Hose Shank

#### Features

- Couplers are supplied standard with a nitrile rubber gasket, other gasket types are available on pages 68 - 71
- All Boss-Lock couplers are supplied with pull-ring safety clips



356T6 aluminum



brass



plated malleable iron



316 stainless steel

Size	356T6 Aluminum Part #	Brass Part #
3/4"	AC075	BC075
1"	AC100	BC100
1-1/4"	AC125	BC125
1-1/2"	AC150	BC150
2"	AC200	BC200
2-1/2"	AC250	BC250
3"	AC300	BC300
4"	AC400	BC400
6"	AC600	BC600
8"	AC800 <sup>1</sup>	---

Size	Plated Malleable Iron Part #	316 Stainless Steel Part #
3/4" x 1/2"	---	RC050BL
3/4"	IC075	RC075BL
1"	IC100	RC100BL
1-1/4"	---	RC125BL
1-1/2"	IC150	RC150BLNO
2"	IC200	RC200BLNO
3"	IC300	RC300BL
4"	IC400 <sup>2</sup>	RC400BLNO
6"	IC600 <sup>2</sup>	---

<sup>1</sup> Dixon and Boss-Lock cam & groove couplings do not interchange in the 8" size

<sup>2</sup> Ductile iron 

## EZ Boss-Lock Type C Couplers with Collared Hose Shank

### Coupler x Collared Hose Shank

**Features**

- Design provides greater resistance to end pull than conventional band clamps and is intended for use with Strap-Grip saddles
  - saddles are sold in pairs and designed for use with 3/4" or 5/8" wide band clamps
  - bands must be purchased separately
- Band clamps should first be applied to the O.D. to seal the hose, then Strap-Grip saddles should be banded over the initial clamp to anchor the fitting in the hose

Size	316 Stainless Steel Part #
1"	RC100CEZ
1-1/2"	RC150CEZ
2"	RC200CEZ



**B**

## Boss-Lock Type C Couplers with Notched Shank

### Coupler x Hose Shank

**Features**

- Coupling can be removed from a damaged hose by cutting away the ferrule, without necessarily damaging the fitting, after inspection of the fitting to determine its suitability for reuse, it can be reinstalled into another hose by using a new ferrule
- System allows you to better manage your inventories, you can stock one coupling and two ferrules, and cover the same hose range with less inventory, you must purchase a fitting and the matching ferrule to create an assembly
- For use with notched ferrules on page 45

Dixon® stems and ferrules are specifically designed to be used together as a coupling system. Due to differences in dimensions and tolerances for safety reasons, do not use other manufacturers' stems or ferrules with Dixon products. 

Size	316 Stainless Steel Part #
1-1/2"	RC150BLNO
2"	RC200BLNO
3"	RC300BLNO
4"	RC400BLNO

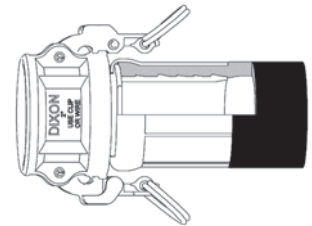

crimped assembly

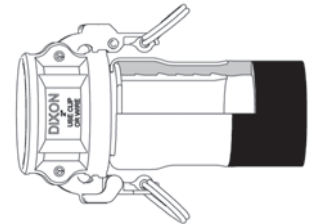

swaged assembly

NOTE: Contact Dixon for swage and crimp recommendations.

B



356T6 aluminum



brass



316 stainless steel

New



AC400EZP<sup>1</sup>

## EZ Boss-Lock Type C Couplers

### Coupler x Hose Shank

#### Feature

- Couplers are supplied standard with a nitrile rubber gasket, other gasket types are available on pages 68 - 71

Size	356T6 Aluminum Part #	Brass Part #	316 Stainless Steel Part #
3/4" x 1/2"	---	---	RC050EZ
3/4"	AC075EZ	BC075EZ	RC075EZ
1"	AC100EZ	BC100EZ	RC100EZCR
1-1/4"	---	BC125EZ	RC125EZCR
1-1/2"	AC150EZ	BC150EZ	RC150EZNO
2"	AC200EZ	BC200EZ	RC200EZNO
2-1/2"	AC250EZ	---	---
3"	AC300EZ	BC300EZ	RC300EZCR
4"	AC400EZ	BC400EZ	RC400EZCR
	AC400EZP <sup>1</sup>	---	---
6"	AC600EZ	---	RC600EZCR
8"	AC800EZ <sup>2</sup>	---	---

<sup>1</sup> Includes paddle handle

<sup>2</sup> Dixon® and Boss-Lock cam & groove couplings do not interchange in the 8" size. Under no circumstances should the EZ Boss-Lock cam arms be used on any fitting not specifically designed for their use.

NOTE: See pages 20 - 23 for further specifications.



## EZ Boss-Lock Type C Couplers with Phono Finish Shank

#### Application

- The shank design on these fittings was developed specifically for chemical transport hoses having Crosslinked Polyethylene (XLPE) or Ultra High Molecular Weight Polyethylene (UHMW) tubes, where shank retention can be a problem when using conventional band clamps.

#### Features

- In testing tank transport hoses from a wide variety of manufacturers, the Boss-Lock PF fitting showed significant improvement in hose coupling retention over the conventional cam & groove shank design
- For best results we recommend the use of 3/4" wide band clamps found on page 469
- Other sizes available; consult Dixon for pricing and availability



Size	316 Stainless Steel Part #	Optional Qty
2"	RC200EZPF	10
3"	RC300EZPF	5



## EZ Boss-Lock Type C Couplers with Swaged Ferrule

### Application

- Developed specifically for chemical transport hoses having Crosslinked Polyethylene (XLPE) or Ultra High Molecular Weight Polyethylene (UHMW) tubes, swaged Boss-Lock provides you with a permanently attached cam & groove fitting when superior coupling retention is required

### Features

- In testing tank transport hoses from a wide variety of manufacturers, the swaged Boss-Lock fitting proved itself to be the clear winner in overall performance
- Available on special order, other sizes or hose O.D.s, consult Dixon® for pricing and availability
- Special equipment required for installation, consult Dixon for pricing and availability or refer to page 572 for more information.

Size	Hose O.D.		316 Stainless Steel Part #
	from	to	
3/4"	1-6/64"	1-22/64"	RC075EZ-70
1"	1-29/64"	1-35/64"	RC100EZ-20
1"	1-36/64"	1-44/64"	RC100EZ-70



B

## EZ Boss-Lock Type C Couplers with Notched Hose Shank

### Coupler x Hose Shank

### Features

- Coupling can be removed from a damaged hose by cutting away the ferrule, without necessarily damaging the fitting, after inspection of the fitting to determine its suitability for reuse, it can be reinstalled into another hose by using a new ferrule.
- System allows you to better manage your inventories, you can stock one coupling and two ferrules, and cover the same hose range with less inventory, you must purchase a fitting and the matching ferrule to create an assembly.
- For use with notched ferrules on page 44

Size	316 Stainless Steel Part #
1-1/2"	RC150EZNO
2"	RC200EZNO
3"	RC300EZNO
4"	RC400EZNO



Dixon stems and ferrules are specifically designed to be used together as a coupling system. Due to differences in dimensions and tolerances for safety reasons, do not use other manufacturers' stems or ferrules with Dixon products.



## Dixon® Type D Couplers

### Coupler x Female NPT

B



356T6 aluminum



aluminum hard coat



brass



unplated malleable iron



316 stainless steel

#### Features

- Couplers are supplied standard with a nitrile rubber gasket, other gasket types are available on pages 68 - 71
- 1/2" Dixon coupler has only one cam arm
- Pull rings are not supplied on 1/2" - 1" Dixon couplings

Size	356T6 Aluminum Part #	Aluminum Hard Coat Part #	Brass Part #
1/2"	50-D-AL	---	50-D-BR
3/4"	75-D-AL	---	75-D-BR
1"	100-D-AL	---	100-D-BR
1-1/4"	125-D-AL	---	125-D-BR
1-1/2"	150-D-AL	150-D-ALH	150-D-BR
2"	200-D-AL	200-D-ALH	200-D-BR
2-1/2"	250-D-AL	---	250-D-BR
3"	300-D-AL	300-D-ALH	300-D-BR
4"	400-D-AL	400-D-ALH	400-D-BR
5"	500-D-AL	---	500-D-BR
6"	600-D-AL	600-D-ALH	600-D-BR
8"	800-D-AL <sup>1,2</sup>	---	---

<sup>1</sup> Dixon and Boss-Lock cam & groove couplings do not interchange in the 8" size

<sup>2</sup> The 8" Dixon design has 4 cam arms



Size	Unplated Malleable Iron Part #	316 Stainless Steel Part #
1/2"	---	50-D-SS
3/4"	---	75-D-SS
1"	---	100-D-SS
1-1/4"	---	125-D-SS
1-1/2"	150-D-MI	150-D-SS
2"	200-D-MI	200-D-SS
2-1/2"	---	250-D-SS
3"	300-D-MI <sup>1</sup>	300-D-SS
4"	400-D-MI <sup>1</sup>	400-D-SS
5"	500-D-MI	500-D-SS
6"	---	600-D-SS

<sup>1</sup> Ductile iron

## Boss-Lock Type D Couplers

### Coupler x Female NPT

#### Features

- Couplers are supplied standard with a nitrile rubber gasket, other gasket types are available on pages 68 - 71
- All Boss-Lock couplers are supplied with pull-ring safety clips

Size	356T6 Aluminum Part #	Brass Part #
3/4" x 1/2"	AD050	BD050
3/4"	AD075	BD075
1"	AD100	BD100
1-1/4"	AD125	BD125
1-1/2"	AD150	BD150
2"	AD200	BD200
2-1/2"	AD250	BD250
3"	AD300	BD300
4"	AD400	BD400
5"	AD500	---
6"	AD600	BD600
8"	AD800 <sup>1</sup>	---

Size	Plated Malleable Iron Part #	316 Stainless Steel Part #
3/4" x 1/2"	---	RD050BL
3/4"	ID075	RD075BL
1"	ID100	RD100BL
1-1/4"	---	RD125BL
1-1/2"	ID150	RD150BL
2"	ID200	RD200BL
3"	ID300	RD300BL
4"	ID400	RD400BL
6"	ID600 <sup>2</sup>	---

<sup>1</sup> Dixon® and Boss-Lock cam & groove couplings do not interchange in the 8" size.

<sup>2</sup> Ductile iron



356T6 aluminum



brass



plated malleable iron



316 stainless steel

**B**

B



356T6 aluminum



brass



316 stainless steel



heavy duty 316 stainless steel



AD400EZP<sup>1</sup>

## EZ Boss-Lock Type D Couplers

### Coupler x Female NPT

#### Feature

- Couplers are supplied standard with a nitrile rubber gasket, other gasket types are available on pages 68 - 71

Under no circumstances should the EZ Boss-Lock cam arms be used on any fitting not specifically designed for their use. See page 22 for further specifications



Size	356T6 Aluminum Part #	Brass Part #
3/4" x 1/2"	---	---
3/4"	AD075EZ	BD075EZ
1"	AD100EZ	BD100EZ
1-1/4"	---	BD125EZ
1-1/2"	AD150EZ	BD150EZ
2"	AD200EZ	BD200EZ
2-1/2"	AD250EZ	BD250EZ
3"	AD300EZ	BD300EZ
4"	AD400EZ	BD400EZ
	AD400EZP <sup>1</sup>	---
5"	AD500EZ	---
6"	AD600EZ	---
8"	AD800EZ <sup>2</sup>	---

Size	316 Stainless Steel Part #	Heavy Duty 316 Stainless Steel Part #
3/4" x 1/2"	RD050EZ	---
3/4"	RD075EZ	---
1"	RD100EZ	---
1-1/4"	RD125EZ	---
1-1/2"	RD150EZ	---
2"	RD200EZ	---
2-1/2"	RD250EZ	---
3"	RD300EZ	RD300EZHD <sup>3</sup>
4"	RD400EZ	RD400EZHD <sup>4</sup>
5"	---	---
6"	RD600EZ	RD600EZHD <sup>5</sup>

<sup>1</sup> Includes paddle handle

<sup>2</sup> Dixon® and Boss-Lock cam & groove couplings do not interchange in the 8" size.

<sup>3</sup> Pressure rating of **400 PSI**

<sup>4</sup> Pressure rating of **300 PSI**

<sup>5</sup> Pressure rating of **150 PSI**



## Type E Adapters Adapter x Hose Shank

**Feature**

- Pressure rating is based on the seal of the mating part, see ratings on page 20

Size	356T6 Aluminum Part #	Aluminum Hard Coat Part #	Brass Part #
1/2"	50-E-AL	---	50-E-BR
3/4" x 1/2"	7550-E-AL	---	---
3/4"	75-E-AL	---	75-E-BR
1"	100-E-AL	---	100-E-BR
1-1/4"	125-E-AL	---	125-E-BR
1-1/2"	150-E-AL	150-E-ALH	150-E-BR
2"	200-E-AL	200-E-ALH	200-E-BR
2-1/2"	250-E-AL	---	250-E-BR
3"	300-E-AL	300-E-ALH	300-E-BR
4"	400-E-AL	400-E-ALH	400-E-BR
5"	500-E-AL	---	---
6"	600-E-AL	600-E-ALH	600-E-BR
8" DIX	800-E-AL <sup>1</sup>	---	---
8" BL	801-E-AL <sup>1</sup>	---	---

<sup>1</sup> Dixon® and Boss-Lock cam & groove couplings do not interchange in the 8" size.



Size	Unplated Malleable Iron Part #	Plated Malleable Iron Part #	316 Stainless Steel Part #
1/2"	---	---	50-E-SS
3/4" x 1/2"	---	---	7550-E-SS
3/4"	---	75-E-PM	75-E-SS
1"	---	100-E-PM	100-E-SS
1-1/4"	---	125-E-PM	125-E-SS
1-1/2"	150-E-MI	150-E-PM	150-E-SS
2"	200-E-MI <sup>2</sup>	200-E-PM <sup>2</sup>	200-E-SS
2-1/2"	---	---	250-E-SS
3"	300-E-MI <sup>1,2</sup>	300-E-PM <sup>1,2</sup>	300-E-SS
4"	400-E-MI <sup>1,2</sup>	400-E-PM <sup>1,2</sup>	400-E-SS
5"	---	---	500-E-SS
6"	600-E-MI <sup>1,2</sup>	600-E-PM <sup>1,2</sup>	600-E-SS

<sup>1</sup> Suitable for King Crimp® sleeves and ferrules, see pages 13 - 16

<sup>2</sup> Ductile iron



356T6 aluminum



aluminum hard coat

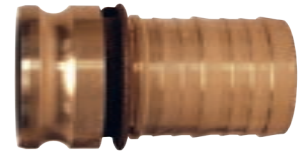

brass



unplated malleable iron



plated malleable iron



316 stainless steel

B

## Type E Adapter with Phono Finish Shank

**Application**

- Shank design developed specifically for chemical transport hoses having crosslinked polyethylene (XLPE) or ultra high molecular weight polyethylene (UHMW) tubes, where shank retention can be a problem when using conventional band clamps.

**Features**

- When testing tank transport hoses from a wide variety of manufacturers, the Boss-Lock PF fitting showed significant improvement in hose coupling retention over the conventional cam & groove shank design
- For best results Dixon recommends the use of 3/4" wide band clamps found on page 469
- Other sizes available, consult Dixon for pricing and availability

Size	316 Stainless Steel Part #	Optional Qty
2"	RE200PF	10



B



swaged assembly

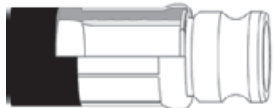

crimped assembly



## Type E Adapters with Swaged Ferrule

### Application

- Developed specifically for chemical transport hoses having Crosslinked Polyethylene (XLPE) or Ultra High Molecular Weight Polyethylene (UHMW) tubes.

### Features

- Provides a permanently attached cam & groove fitting when superior coupling retention is required
- Testing tank transport hoses from a wide variety of manufacturers proved the swaged Boss-Lock fitting to be the leader in overall performance
- Other sizes or hose O.D.s available on special order. Consult Dixon® for pricing and availability
- Special equipment required for installation, consult Dixon for pricing and availability or refer to page 572 for more information

Size	Hose O.D.		316 Stainless Steel Part #
	from	to	
3/4"	1-6/64"	1-22/64"	RE075-1370
1"	1-29/64"	1-35/64"	RE100-1620
1"	1-36/64"	1-44/64"	RE100-1770

## Type E Adapters with Notched Shank

### Adapter x Hose Shank

### Features

- Can be removed from a damaged hose by cutting away the ferrule without necessarily damaging the fitting, after inspection of the fitting to determine its suitability for reuse, it can be reinstalled into another hose by using a new ferrule
- System allows you to better manage your inventory: stock one coupling and two ferrules and cover the same hose range with less inventory, you must purchase a fitting and the matching ferrule to create an assembly
- For use with notched ferrules below

Dixon stems and ferrules are specifically designed to be used together as a coupling system. Due to differences in dimensions and tolerances for safety reasons, do not use other manufacturers' stems or ferrules with Dixon products. 

Size	316 Stainless Steel Part #
1-1/2"	RE150NO
2"	RE200NO
3"	RE300NO
4"	RE400NO

## Notched Ferrules

- Reference notched shanks and adapters above
- Dixon stems and ferrules are specifically designed to be used together as a coupling system, due to differences in dimensions and tolerances for safety reasons, do not use other manufacturers' stems or ferrules with Holedall® products. 

Size	Hose O.D.		304 Stainless Steel Part #
	From	To	
1-1/2"	1-60/64"	2-12/64"	GAS2334NO
	2-4/64"	2-22/64"	GAS2370NO
2"	2-30/64"	2-44/64"	GAS2709NO
	2-42/64"	2-54/64"	GAS2885NO
2-1/2"	2-54/64"	3"	GAS3012NO
	3-1/64"	3-13/64"	GAS3260NO
3"	3-30/64"	3-46/64"	GAS3760NO
	3-47/64"	3-54/64"	GAS3885NO
4"	4-40/64"	4-47/64"	GAS5010NO

## Type E Adapters with Notched NOS shank

### Adapter x Shank

#### Features

- System allows you to better manage your inventories, you can stock one stem and two ferrules, and cover the same hose range with less inventory, you must purchase a fitting and the matching ferrule to create an assembly
- For hose outside diameters of 2-4/64" and below, the couplings are crimp only 
- For hose outside diameters of 2-5/64" and above, the couplings can be crimped or swaged
- For use with notched ferrules on page 44
- See page 363 for male NPT notched NOS fittings

Size	316 Stainless Steel Part #
1-1/2"	150ENOSSS <sup>1</sup>
2"	200ENOSSS
3"	300ENOSSS

<sup>1</sup> Part will be discontinued as stock is depleted

Only use the NOS shank with the NOS ferrules.

Due to differences in dimensions and tolerances for safety reasons, do not use other manufacturers' stems or ferrules with Dixon® products. 



**B**

## Notched NOS Ferrules

Size	Hose O.D.		304 Stainless Steel Part #
	From	To	
1-1/2"	1-60/64"	2-12/64"	GAS2334NOS
	2-4/64"	2-22/64"	GAS2370NOS
2"	2-30/64"	2-44/64"	GAS2709NOS
	2-42/64"	2-54/64"	GAS2885NOS
3"	3-30/64"	3-46/64"	GAS3760NOS
	3-47/64"	3-54/64"	GAS3885NOS
4"	4-40/64"	4-47/64"	GAS5010NOS



NOTE: Reference notched shanks on page 363 and adapters above

B



356T6 aluminum



aluminum hard coat



brass



unplated malleable iron



plated malleable iron



316 stainless

## Type F Adapters x NPT

### Adapter x Male NPT

Size	356T6 Aluminum Part #	Aluminum Hard Coat Part #	Brass Part #
1/2"	50-F-AL	---	50-F-BR
3/4" x 1/2"	7550-F-AL	---	7550-F-BR
3/4"	75-F-AL	---	75-F-BR
1"	100-F-AL	---	100-F-BR
1-1/4"	125-F-AL	---	125-F-BR
1-1/2"	150-F-AL	150-F-ALH	150-F-BR
2"	200-F-AL	200-F-ALH	200-F-BR
2-1/2"	250-F-AL	---	250-F-BR
3"	300-F-AL	300-F-ALH	300-F-BR
4"	400-F-AL	400-F-ALH	400-F-BR
5"	500-F-AL	---	---
6"	600-F-AL	600-F-ALH	600-F-BR
8" DIX	800-F-AL <sup>1</sup>	---	---
8" BL	801-F-AL <sup>1</sup>	---	---

<sup>1</sup> Dixon® and Boss-Lock cam & groove couplings do not interchange in the 8" size.  
NOTE: Pressure rating is based on the seal of the mating part. See ratings on page 20.



Size	Unplated Malleable Iron Part #	Plated Malleable Iron Part #	316 Stainless Steel Part #
1/2"	---	---	50-F-SS
3/4" x 1/2"	---	---	7550-F-SS
3/4"	---	75-F-PM	75-F-SS
1"	---	100-F-PM	100-F-SS
1-1/4"	---	---	125-F-SS
1-1/2"	150-F-MI	150-F-PM	150-F-SS
2"	200-F-MI	200-F-PM	200-F-SS
2-1/2"	---	---	250-F-SS
3"	300-F-MI	300-F-PM	300-F-SS
4"	400-F-MI	400-F-PM	400-F-SS
6"	---	600-F-PM	600-F-SS



## Dixon® Type DC Dust Caps

### Features

- Nitrile rubber gasket supplied standard; other gaskets available on pages 68 - 71
- 1/2" Dixon has only one cam arm
- Pull rings are not supplied on 1/2" - 1" Dixon couplings

Size	356T6 Aluminum Part #	Aluminum Hard Coat Part #	Brass Part #
1/2"	50-DC-AL	---	50-DC-BR
3/4"	75-DC-AL	---	75-DC-BR
1"	100-DC-AL	---	100-DC-BR
1-1/2"	150-DC-AL	150-DC-ALH	150-DC-BR
2"	200-DC-AL	200-DC-ALH	200-DC-BR
2-1/2"	250-DC-AL	---	---
3"	300-DC-AL	300-DC-ALH	300-DC-BR
4"	400-DC-AL	400-DC-ALH	400-DC-BR
5"	500-DC-AL	---	500-DC-BR
6"	600-DC-AL	600-DC-ALH	---
8"	800-DC-AL <sup>1,2</sup>	---	---

<sup>1</sup> Dixon and Boss-Lock cam & groove couplings do not interchange in the 8" size

<sup>2</sup> The 8" Dixon dust cap has 2 cam arms



Size	Unplated Malleable Iron Part #	316 Stainless Steel Part #
1/2"	---	50-DC-SS
3/4"	---	75-DC-SS
1"	---	100-DC-SS
1-1/2"	---	150-DC-SS
2"	200-DC-MI	200-DC-SS
2-1/2"	---	250-DC-SS
3"	300-DC-MI	300-DC-SS
4"	400-DC-MI	400-DC-SS
5"	---	500-DC-SS
6"	---	600-DC-SS



356T6 aluminum



aluminum hard coat



brass



unplated malleable iron



316 stainless steel

B

**B**

### Dixon® Lockable Dust Caps

**Features**

- Nitrile rubber gasket standard, other gaskets available on pages 68 - 71
- Dust caps and dust plugs are not to be used in pressure applications for safety and environmental reasons 



Size	356T6 Aluminum Part #	Brass Part #
1-1/2"	150DC-LAL	150DC-LBR
2"	200DC-LAL	200DC-LBR
3"	300DC-LAL	300DC-LBR
4"	400DC-LAL	---
6"	600DC-LAL	---

**Feature**

- Angled, ergonomic thumb release



Size	316 Stainless Steel Part #
1-1/2"	150DC-LSS
2"	200DC-LSS
3"	300DC-LSS
4"	400DC-LSS

### Boss-Lock Type H Dust Caps

**Features**

- Nitrile rubber gasket standard, other gaskets available on pages 68 - 71
- Supplied with pull-ring safety clips
- Dust caps and dust plugs are not to be used in pressure applications for safety and environmental reasons 



356T6 aluminum

Size	356T6 Aluminum Part #	Brass Part #
1"	AH100	BH100
1-1/4"	AH125	BH125
1-1/2"	AH150	BH150
2"	AH200	BH200
2-1/2"	AH250	BH250
3"	AH300	BH300
4"	AH400	BH400
6"	AH600	BH600
8"	AH800 <sup>1</sup>	---



brass



plated malleable iron

Size	Plated Malleable Iron Part #	316 Stainless Steel Part #
3/4"	---	RH075BL
1"	---	RH100BL
1-1/4"	---	RH125BL
1-1/2"	IH150	RH150BL
2"	IH200	RH200BL
3"	IH300	RH300BL
4"	IH400	RH400BL
6"	IH600	---



316 stainless steel

<sup>1</sup> Dixon and Boss-Lock cam & groove couplings do not interchange in the 8" size 

### EZ Boss-Lock Type H Dust Caps

**Features**

- Nitrile rubber gasket standard, other gaskets available on pages 68 - 71
- Dust caps and dust plugs are not to be used in pressure applications for safety and environmental reason 

Size	356T6 Aluminum Part #	Brass Part #	316 Stainless Steel Part #
3/4"	---	---	RH075EZ
1"	AH100EZ	BH100EZ	RH100EZ
1-1/4"	---	---	RH125EZ
1-1/2"	AH150EZ	BH150EZ	RH150EZ
2"	AH200EZ	BH200EZ	RH200EZ
2-1/2"	AH250EZ	---	---
3"	AH300EZ	BH300EZ	RH300EZ
4"	AH400EZ	---	RH400EZ
6"	AH600EZ	---	RH600EZ

NOTE: Under no circumstances should the EZ Boss-Lock cam arms be used on any fitting not specifically designed for their use. See pages 22 and 67 for further specifications. 



356T6 aluminum

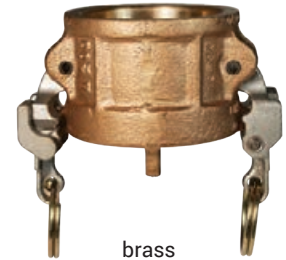

brass



316 stainless steel

**B**

## Type DP Dust Plugs

B



356T6 aluminum



aluminum hard coat



brass



unplated malleable iron



plated malleable iron



316 stainless steel

### Feature

- Dust caps and dust plugs are not to be used in pressure applications for safety and environmental reasons



Size	356T6 Aluminum Part #	Aluminum Hard Coat Part #	Brass Part #
1/2"	---	---	50-DP-BR
3/4"	75-DP-AL	---	75-DP-BR
1"	100-DP-AL	---	100-DP-BR
1-1/4"	125-DP-AL	---	125-DP-BR
1-1/2"	150-DP-AL	150-DP-ALH	150-DP-BR
2"	200-DP-AL	200-DP-ALH	200-DP-BR
2-1/2"	250-DP-AL	---	---
3"	300-DP-AL	300-DP-ALH	300-DP-BR
4"	400-DP-AL	400-DP-ALH	400-DP-BR
5"	500-DP-AL	---	---
6"	600-DP-AL	600-DP-ALH	600-DP-BR
8" DIX	800-DP-AL <sup>1</sup>	---	---
8" BL	801-DP-AL <sup>1</sup>	---	---

<sup>1</sup> Dixon® and Boss-Lock cam & groove couplings do not interchange in the 8" size



Size	Unplated Malleable Iron Part #	Plated Malleable Iron Part #	316 Stainless Steel Part #
1/2"	---	---	50-DP-SS <sup>1</sup>
3/4"	---	---	75-DP-SS
1"	---	---	100-DP-SS
1-1/4"	---	125-DP-PM	125-DP-SS
1-1/2"	150-DP-MI	150-DP-PM	150-DP-SS
2"	200-DP-MI	200-DP-PM	200-DP-SS
2-1/2"	---	250-DP-PM	250-DP-SS
3"	300-DP-MI	300-DP-PM	300-DP-SS
4"	400-DP-MI	400-DP-PM	400-DP-SS
6"	---	---	600-DP-SS

**Hastelloy® Cam & Groove  
Type A Adapters  
Adapter x Female NPT**

**B**

Size	Hastelloy CW12MW Part #
1"	100-A-HA
1-1/2"	150-A-HA
2"	200-A-HA
3"	300-A-HA



NOTE: Pressure rating is based on the seal material of the mating part. See rating on page 20.

**Hastelloy Cam & Groove  
Type E Adapters  
Adapter x Shank**

Size	Hastelloy CW12MW Part #
1"	100-E-HA <sup>1</sup>
1-1/2"	150-E-HA
2"	200-E-HA <sup>1</sup>
3"	300-E-HA



<sup>1</sup> Have King Crimp® shank

NOTE: Pressure rating is based on the seal material of the mating part. See rating on page 20

**Hastelloy Cam & Groove  
Type F Adapters  
Adapter x Male NPT**

Size	Hastelloy CW12MW Part #
1"	100-F-HA
1-1/2"	150-F-HA
2"	200-F-HA
3"	300-F-HA



NOTE: Pressure rating is based on the seal material of the mating part. See rating on page 20.

### Hastelloy® Cam & Groove EZ Boss-Lock Type B Couplers Coupler x Male NPT

**Feature**

- Couplers supplied with FKM-A gaskets

**Materials**

- Cam arms: 316 stainless steel
- Pins: 302 stainless steel
- Rings: yellow zinc plated 12 gauge steel wire



Size	Hastelloy CW12MW Part #
1"	HAB100EZ
1-1/2"	HAB150EZ
2"	HAB200EZ
3"	HAB300EZ

### Hastelloy Cam & Groove EZ Boss-Lock Type C Couplers Coupler x Hose Shank

**Feature**

- Couplers supplied with FKM-A gaskets

**Materials**

- Cam arms: 316 stainless steel
- Pins: 302 stainless steel
- Rings: yellow zinc plated 12 gauge steel wire



Size	Hastelloy CW12MW Part #
1"	HAC100EZ <sup>1</sup>
1-1/2"	HAC150EZ
2"	HAC200EZ <sup>1</sup>
3"	HAC300EZ

<sup>1</sup> King Crimp® shank

### Hastelloy Cam & Groove EZ Boss-Lock Type D Couplers Coupler x Female NPT

**Feature**

- Couplers supplied with FKM-A gaskets

**Materials**

- Cam arms: 316 stainless steel
- Pins: 302 stainless steel
- Rings: yellow zinc plated 12 gauge steel wire



Size	Hastelloy CW12MW Part #
1"	HAD100EZ
1-1/2"	HAD150EZ
2"	HAD200EZ
3"	HAD300EZ

### Type DA Couplings with Port Coupler x Adapter

**Feature**

- Nitrile rubber gasket standard, other gaskets available on pages 68 - 71

Size	Port	316 Stainless Steel Part #
3" x 3"	1/4"	300DAT25SS
3" x 3"	3/8"	300DAT38SS
3" x 3"	1/2"	300DAT50SS
3" x 3"	3/4"	300DAT75SS



### Type DA Jump Size Couplings Coupler x Adapter

**Feature**

- Nitrile rubber gasket standard, other gaskets available on pages 68 - 71

Size	356T6 Aluminum Part #	316 Stainless Steel Part #
1" x 1-1/2"	1015-DA-AL <sup>1</sup>	1015-DA-SS <sup>1</sup>
1-1/2" x 1"	1510DAAL	1510-DA-SS <sup>1</sup>
1-1/2" x 2"	1520-DA-AL	1520-DA-SS
2" x 1"	2010-DA-AL <sup>1</sup>	2010-DA-SS
2" x 1-1/2"	2015-DA-AL	2015-DA-SS
2" x 2-1/2"	2025-DA-AL <sup>1</sup>	2025-DA-SS <sup>1</sup>
2" x 3"	2030-DA-AL	2030-DA-SS
2" x 4"	2040-DA-AL	2040-DA-SS <sup>1</sup>
2-1/2" x 2"	---	2520-DA-SS <sup>1</sup>
2-1/2" x 3"	---	2530-DA-SS <sup>1</sup>
3" x 1-1/2"	3015-DA-AL	3015-DA-SS <sup>1</sup>
3" x 2"	3020-DA-AL	3020-DA-SS
3" x 2-1/2"	3025-DA-AL	3025-DA-SS <sup>1</sup>
3" x 4"	3040-DA-AL	3040-DA-SS
3" x 6"	3060-DA-AL <sup>1</sup>	3060-DA-SS <sup>1</sup>
4" x 2"	4020-DA-AL	4020-DA-SS <sup>1</sup>
4" x 2-1/2"	4025-DA-AL	4025-DA-SS <sup>1</sup>
4" x 3"	4030-DA-AL	4030-DA-SS
4" x 5"	4050-DA-AL	---
4" x 6"	4060-DA-AL	4060-DA-SS <sup>1</sup>
5" x 3"	5030-DA-AL <sup>1</sup>	5030-DA-SS <sup>1</sup>
5" x 4"	5040-DA-AL	5040-DA-SS <sup>1</sup>
5" x 6"	5060-DA-AL <sup>1</sup>	5060-DA-SS <sup>1</sup>
6" x 3"	6030-DA-AL	6030-DA-SS <sup>1</sup>
6" x 4"	6040-DA-AL	6040-DA-SS
6" x 5"	6050-DA-AL	6050-DA-SS <sup>1</sup>
8" x 6"	8060-DA-AL <sup>1,2</sup>	---



4030-DA-SS



4060-DA-AL



2015-DA-AL



5060-DA-AL

<sup>1</sup> Parts are produced as a welded fabrication  
<sup>2</sup> The 8" coupler only interchanges with Dixon® adapters.



Size	Brass Part #	Unplated Malleable Iron Part #
3" x 2"	3020-DA-BR	3020-DA-MI
3" x 4"	3040-DA-BR	---
4" x 3"	4030-DA-BR	4030-DA-MI
6" x 4"	6040-DA-BR	6040-DA-MI

NOTE: In jump size cam & groove couplings, the coupler is the first size in the part number. (i.e., a 4030-DA-AL is a 4" coupler to a 3" adapter)

B

### Boss-Lock Type DA Jump Size Coupler x Adapter

**Features**

- Nitrile rubber gasket standard, other gaskets available on pages 68 - 71
- All Boss-Lock couplers are supplied with pull-ring safety clips



Size	356T6 Aluminum Part #	316 Stainless Steel Part #
2" x 3"	ADA2030 <sup>1</sup>	RDA2030BL <sup>1</sup>
2-1/2" x 2"	ADA2520 <sup>1</sup>	---
2-1/2" x 3"	ADA2530 <sup>1</sup>	---
3" x 2"	ADA3020	RDA3020BL
3" x 4"	ADA3040 <sup>1</sup>	RDA3040BL <sup>1</sup>
4" x 2"	ADA4020 <sup>1</sup>	RDA4020BL <sup>1</sup>
4" x 3"	ADA4030	RDA4030BL
6" x 4"	ADA6040 <sup>1</sup>	---
8" x 6"	ADA8060 <sup>1,2</sup>	---

<sup>1</sup> Parts are produced as a welded fabrication

<sup>2</sup> The 8" coupler only interchanges with 8" Boss-Lock couplings.



NOTE: In jump size cam & groove couplings, the coupler is the first size in the part number. (i.e., a ADA4030 is a 4" coupler to a 3" adapter)

### EZ Boss-Lock Type DA Jump Size Coupler x Adapter

**Feature**

- Nitrile rubber gasket standard, other gaskets available on pages 68 - 71

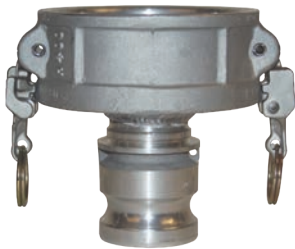

Size	356T6 Aluminum Part #	316 Stainless Steel Part #
2" x 1"	---	RDA2010EZ <sup>1</sup>
2" x 3"	ADA2030EZ <sup>1</sup>	RDA2030EZ <sup>1</sup>
3" x 2"	ADA3020EZ	RDA3020EZ
3" x 4"	ADA3040EZ <sup>1</sup>	RDA3040EZ <sup>1</sup>
4" x 2"	ADA4020EZ <sup>1</sup>	RDA4020EZ <sup>1</sup>
4" x 3"	ADA4030EZ	RDA4030EZ
6" x 4"	ADA6040EZ <sup>1</sup>	RDA6040EZ

<sup>1</sup> Parts are produced as a welded fabrication

NOTE: In jump size cam & groove couplings, the coupler is the first size in the part number. (i.e., a ADA4030EZ is a 4" coupler to a 3" adapter)

### Dixon® Type DA Jump Size with Port Coupler x Adapter

**Feature**

- Nitrile rubber gasket standard, other gaskets available on pages 68 - 71

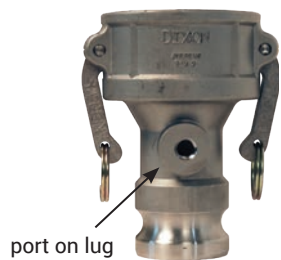

Size	Port	316 Stainless Steel Part #
3" x 2"	1/4"	3020DAT25SS
3" x 2"	3/8"	3020DAT38SS
3" x 2"	1/2"	3020DAT50SS
3" x 2"	3/4"	3020DAT75SS

NOTE: In jump size cam & groove couplings, the coupler is the first size in the part number. (i.e., a ADA4030EZ is a 4" coupler to a 3" adapter)



## Type AA Spool Adapters

### Adapter x Adapter

**Feature**

- Pressure rating is based on the seal of the mating part, see ratings on page 20

Size	356T6 Aluminum Part #	316 Stainless Steel Part #	Unplated Malleable Iron Part #
1"	---	100-AA-SS	---
1-1/4"	---	125-AA-SS <sup>1</sup>	---
1-1/2"	150-AA-AL	150-AA-SS	---
1-1/2" x 2"	1520-AA-AL	1520-AA-SS	---
2"	200-AA-AL	200-AA-SS	---
2" x 3"	2030-AA-AL	2030-AA-SS	---
2" x 4"	2040-AA-AL	2040-AA-SS <sup>1</sup>	---
2-1/2" x 3"	2530-AA-AL <sup>1</sup>	2530-AA-SS <sup>1</sup>	---
2-1/2" x 4"	2540-AA-AL <sup>1</sup>	---	---
3"	300-AA-AL	300-AA-SS	---
3" x 4"	3040-AA-AL	3040-AA-SS <sup>1</sup>	---
4"	400-AA-AL	400-AA-SS	400-AA-MI
4" x 5"	4050-AA-AL	---	---
4" x 6"	4060-AA-AL	4060-AA-SS <sup>1</sup>	---
5"	500-AA-AL <sup>1</sup>	500-AA-SS <sup>1</sup>	---
5" x 6"	5060-AA-AL <sup>1</sup>	---	---
6"	600-AA-AL	600-AA-SS <sup>1</sup>	---

<sup>1</sup> Parts are produced as a welded fabrication

Size	Brass Part #
2"	200-AA-BR
3"	300-AA-BR

## Dixon® Type DD Couplers

### Coupler x Coupler

**Feature**

- Nitrile rubber gasket standard, other gaskets available on pages 68 - 71

Size	356T6 Aluminum Part #	316 Stainless Steel Part #
1-1/2"	---	150-DD-SS <sup>1</sup>
2"	200-DD-AL	200-DD-SS
2" x 3"	2030-DD-AL	2030-DD-SS
3"	300-DD-AL	300-DD-SS
3" x 4"	3040-DD-AL	3040-DD-SS <sup>1</sup>
4"	400-DD-AL	400-DD-SS
4" x 5"	4050-DD-AL <sup>1</sup>	4050-DD-SS <sup>1</sup>
4" x 6"	4060-DD-AL <sup>1</sup>	4060-DD-SS
5"	500-DD-AL <sup>1</sup>	500-DD-SS
6"	600-DD-AL	---

<sup>1</sup> Parts are produced as a welded fabrication

## Boss-Lock Type DD Couplers

### Coupler x Coupler

**Features**

- Nitrile rubber gasket standard, other gaskets available on pages 68 - 71
- All Boss-Lock couplers are supplied with pull-ring safety clips

Size	356T6 Aluminum Part #	316 Stainless Steel Part #
2"	ADD200 <sup>1</sup>	RDD200EZ
2" x 1"	---	RDD2010EZ <sup>1</sup>
2" x 3"	ADD2030 <sup>1</sup>	RDD2030EZ <sup>1</sup>
3"	ADD300 <sup>1</sup>	RDD300EZ <sup>1</sup>
3" x 4"	ADD3040 <sup>1</sup>	RDD3040EZ <sup>1</sup>
4"	ADD400 <sup>1</sup>	RDD400EZ <sup>1</sup>
6"	---	RDD600EZ <sup>1</sup>

<sup>1</sup> Parts are produced as a welded fabrication

B



increaser / reducer



same size



reducer / increaser



same size



reducer / increaser



same size

B



### Type A Jump Size Adapters

**Feature** Adapter x Female NPT

- Pressure rating is based on the seal of the mating part, see ratings on page 20

Size	356T6 Aluminum Part #	Brass Part #	316 Stainless Steel Part #
2" x 1-1/2"	2015-A-AL	---	2015-A-SS <sup>1</sup>
2" x 3"	2030-A-AL	---	2030-A-SS
2-1/2" x 2"	---	2520-A-BR	---
3" x 2"	3020-A-AL	---	3020-A-SS
3" x 4"	3040-A-AL	---	---
4" x 3"	4030-A-AL	---	4030-A-SS <sup>1</sup>
4" x 6"	4060-A-AL	---	---
6" x 4"	6040-A-AL	---	6040-A-SS <sup>1</sup>

<sup>1</sup> Parts are produced as a welded fabrication

NOTE: In jump size couplings, the cam & groove end is the first size given in the part number. (i.e., a 4030-C-AL is a 4" coupler to a 3" hose shank).

### Dixon® Type B Jump Size Couplers

**Coupler x Male NPT**

**Feature**

- Nitrile rubber gasket standard, other gaskets available on pages 68 - 71



Size	356T6 Aluminum Part #	316 Stainless Steel Part #
1-1/2" x 1"	1510-B-AL	1510-B-SS <sup>1</sup>
2" x 1-1/2"	2015-B-AL	2015-B-SS <sup>1</sup>
2" x 3"	2030-B-AL	---
3" x 2"	3020-B-AL	3020-B-SS <sup>1</sup>
3" x 4"	3040-B-AL	---
4" x 3"	4030-B-AL	4030-B-SS <sup>1</sup>

<sup>1</sup> Parts are produced as a welded fabrication

NOTE: In jump size couplings, the cam & groove end is the first size given in the part number. (i.e., a 4030-C-AL is a 4" coupler to a 3" hose shank).

### Dixon Type C Jump Size Couplers

**Coupler x Hose Shank**

**Feature**

- Nitrile rubber gasket standard, other gaskets available on pages 68 - 71



Size	356T6 Aluminum Part #	316 Stainless Steel Part #
1-1/2" x 1"	---	1510-C-SS
2" x 1-1/2"	2015-C-AL <sup>1</sup>	2015-C-SS <sup>1</sup>
3" x 2"	3020-C-AL	3020-C-SS
3" x 2-1/2"	---	3025-C-SS
3" x 4"	3040-C-AL	---
4" x 3"	4030-C-AL	4030-C-SS <sup>1</sup>
5" x 4"	5040-C-AL <sup>1</sup>	---

<sup>1</sup> Parts are produced as a welded fabrication

NOTE: In jump size couplings, the cam & groove end is the first size given in the part number. (i.e., a 4030-C-AL is a 4" coupler to a 3" hose shank).

### EZ Boss-Lock Type C Jump Size Coupler

**Coupler x King Crimp® Hose Shank**

**Feature**

- Nitrile rubber gasket standard, other gaskets available on pages 68 - 71



Size	316 Stainless Steel Part #
3" x 2-1/2"	RC3025EZCR

NOTE: In jump size couplings, the cam & groove end is the first size given in the part number. (i.e., a 4030-C-AL is a 4" coupler to a 3" hose shank).

## Dixon® Type D Jump Size Couplers

### Coupler x Female NPT

**Feature**

- Nitrile rubber gasket standard, other gaskets available on pages 68 - 71

Size	356T6 Aluminum Part #	Optional Qty	Brass Part #	316 Stainless Steel Part #
1-1/2" x 1"	1510-D-AL	10	---	1510-D-SS <sup>1</sup>
2" x 1-1/2"	2015-D-AL	10	---	2015-D-SS
3" x 2"	3020-D-AL	10	---	3020-D-SS
4" x 3"	4030-D-AL	10	4030-D-BR	4030-D-SS <sup>1</sup>
5" x 4"	5040-D-AL <sup>1</sup>	---	---	---
6" x 4"	6040-D-AL <sup>1</sup>	---	---	---

<sup>1</sup> Parts are produced as a welded fabrication

NOTE: In jump size couplings, the cam & groove end is the first size given in the part number. (i.e., a 4030-C-AL is a 4" coupler to a 3" hose shank).

**B**

## Type E Jump Size Adapters

### Adapter x Hose Shank

**Feature**

- Pressure rating is based on the seal of the mating part, see ratings on page 20

Size	356T6 Aluminum Part #	316 Stainless Steel Part #
1-1/2" x 1"	---	1510-E-SS
2" x 1-1/2"	2015-E-AL <sup>1</sup>	2015-E-SS <sup>1</sup>
3" x 2"	---	3020-E-SS <sup>1</sup>
3" x 2-1/2"	---	3025-E-SS
4" x 3"	4030-E-AL	4030-E-SS <sup>1</sup>
5" x 4"	5040-E-AL <sup>1</sup>	---

<sup>1</sup> Parts are produced as a welded fabrication

NOTE: In jump size couplings, the cam & groove end is the first size given in the part number. (i.e., a 4030-B-AL is a 4" coupler to a 3" male NPT).



## Type F Jump Size Adapters

### Adapter x Male NPT

**Feature**

- Pressure rating is based on the seal of the mating part, see ratings on page 20

Size	356T6 Aluminum Part #	316 Stainless Steel Part #
1-1/2" x 2"	1520-F-AL	---
2" x 1-1/2"	2015-F-AL	2015-F-SS
2" x 3"	2030-F-AL	---
3" x 1-1/2"	3015-F-AL	3015-F-SS <sup>1</sup>
3" x 2"	3020-F-AL	3020-F-SS
3" x 4"	3040-F-AL	---
4" x 3"	4030-F-AL	4030-F-SS

<sup>1</sup> Parts are produced as a welded fabrication

NOTE: In jump size couplings, the cam & groove end is the first size given in the part number. (i.e., a 4030-C-AL is a 4" coupler to a 3" hose shank).



B

### Dixon® Type DA 45° Elbows

#### Adapter x Coupler

**Feature**

- Nitrile rubber gasket standard, other gaskets available on pages 68 - 71



Size	356T6 Aluminum Part #	316 Stainless Steel Part #	Unplated Malleable Iron Part #
2"	200DA-45AL <sup>1</sup>	200DA-45SS <sup>1</sup>	---
3"	300DA-45AL	300DA-45SS <sup>1</sup>	---
4"	400DA-45AL	400DA-45SS <sup>1</sup>	400DA-45MI
6"	600DA-45AL	---	---

<sup>1</sup> Part is produced as a welded fabrication

### Dixon Type DD 45° Elbows

#### Coupler x Coupler

**Feature**

- Nitrile rubber gasket standard, other gaskets available on pages 68 - 71



Size	356T6 Aluminum Part #	316 Stainless Steel Part #
2"	200DD-45AL <sup>1</sup>	---
3"	300DD-45AL <sup>1</sup>	300DD-45SS <sup>1</sup>
4"	400DD-45AL	---
6"	600DD-45AL <sup>1</sup>	---

<sup>1</sup> Part is produced as a welded fabrication

### Dixon Type DA 90° Elbows

#### Adapter x Coupler

**Feature**

- Nitrile rubber gasket standard, other gaskets available on pages 68 - 71



Size	356T6 Aluminum Part #	316 Stainless Steel Part #
1"	---	100DA-90SS <sup>1</sup>
1-1/2"	150DA-90AL <sup>1</sup>	150DA-90SS <sup>1</sup>
2"	200DA-90AL	200DA-90SS
3"	300DA-90AL	300DA-90SS
4"	400DA-90AL	400DA-90SS
5"	500DA-90AL <sup>1</sup>	---
6"	600DA-90AL	RDA90600EZ <sup>1,2</sup>

<sup>1</sup> Part is produced as a welded fabrication

<sup>2</sup> EZ Boss-Lock design (not pictured)

### Dixon Type DD 90° Elbows

#### Coupler x Coupler

**Feature**

- Nitrile rubber gasket standard, other gaskets available on pages 68 - 71



Size	356T6 Aluminum Part #	316 Stainless Steel Part #
2"	200DD-90AL	---
3"	300DD-90AL	300DD-90SS <sup>1</sup>
4"	400DD-90AL	---
6"	600DD-90AL	---

<sup>1</sup> Part is produced as a welded fabrication

### Type A 90° Adapters Elbows

#### Adapter x Female NPT

**Feature**

- Pressure rating is based on the seal of the mating part, see ratings on page 20



Size	356T6 Aluminum Part #	316 Stainless Steel Part #
1-1/2"	150A-90AL	---
2"	200A-90AL	200A-90SS <sup>1</sup>
3"	300A-90AL	300A-90SS
4"	400A-90AL	---

<sup>1</sup> Part is produced as a welded fabrication

### Type B 90° Dixon® Elbows Coupler x Male NPT

**Feature**

- Nitrile rubber gasket standard, other gaskets available on pages 68 - 71

Size	356T6 Aluminum Part #	316 Stainless Steel Part #
1-1/2"	150B-90AL	---
2"	200B-90AL	200B-90SS <sup>1</sup>
3"	---	300B-90SS <sup>1</sup>

<sup>1</sup> Parts are produced as a welded fabrication.



**B**

### Type C 90° Dixon Elbows Coupler x Hose Shank

**Feature**

- Nitrile rubber gasket standard, other gaskets available on pages 68 - 71

Size	356T6 Aluminum Part #	Brass Part #	316 Stainless Steel Part #
1-1/4"	---	125C-90BR	---
1-1/2"	150C-90AL	---	150C-90SS
2"	200C-90AL	200C-90BR	200C-90SS
3"	300C-90AL	---	300C-90SS
4"	400C-90AL	---	400C-90SS <sup>1</sup>
6"	600C-90AL	---	---

<sup>1</sup> Part is produced as a welded fabrication



### Type D 90° Dixon Elbows Coupler x Female NPT

**Feature**

- Nitrile rubber gasket standard, other gaskets available on pages 68 - 71

Size	356T6 Aluminum Part #	Brass Part #	316 Stainless Steel Part #
1"	---	---	100D-90SS
1-1/4"	---	125D-90BR	---
1-1/2"	150D-90AL	150D-90BR	---
2"	200D-90AL	200D-90BR	200D-90SS
2"	---	BD90200EZ <sup>2</sup>	---
3"	300D-90AL	---	300D-90SS
4"	400D-90AL	---	400D-90SS <sup>1</sup>
4"	AD90400EZ <sup>2</sup>	---	---
6"	600D-90AL	---	---

<sup>1</sup> Part is produced as a welded fabrication

<sup>2</sup> EZ Boss-Lock design



EZ Boss-Lock design

## Type E 90° Elbows

Adapter x Hose Shank

B



**Feature**

- Pressure rating is based on the seal of the mating part, see ratings on page 20

Size	356T6 Aluminum Part #	316 Stainless Steel Part #
2"	---	200E-90SS <sup>1</sup>
3"	300E-90AL	300E-90SS
4"	400E-90AL	400E-90SS <sup>1</sup>

<sup>1</sup> Parts are produced as a welded fabrication

## Type F 90° Elbows

Adapter x Male NPT



**Feature**

- Pressure rating is based on the seal of the mating part, see ratings on page 20

Size	356T6 Aluminum Part #	316 Stainless Steel Part #
1-1/2"	150F-90AL	---
2"	200F90AL	200F-90SS <sup>1</sup>
3"	---	300F-90SS <sup>1</sup>

<sup>1</sup> Parts are produced as a welded fabrication

New

## Type F 15° Elbows

Adapter x Male NPT



**Feature**

- Pressure rating is based on the seal of the mating part, see ratings on page 20

Size	316 Stainless Steel Part #
2"	200F-15SS

## Adapter x 150# Flange

### Features

- Aluminum and unplated iron flanges are flat face
- Stainless steel flanges are raised face
- Reference dixonvalve.com for flange bolt hole drilling circle standards
- Flanges are designed to mate with 150# flanges
- Flanges have the same bolt hole pattern as an ANSI 150 lb. flange, the thickness may vary

Size	356T6 Aluminum Part #	Flange Thick.	Unplated Malleable Iron Part #	Flange Thick.	316 Stainless Steel Part #	Flange Thick.
1"	---	---	---	---	100-AL-SS	9/16"
1-1/2"	---	---	---	---	150-AL-SS	11/16"
2"	200-AL-AL	3/4"	---	---	200-AL-SS	7/16"
3"	300-AL-AL	5/8"	300-AL-MI	5/8"	300-AL-SS	7/16"
4"	400-AL-AL	5/8"	---	---	400-AL-SS	7/16"
6"	600-AL-AL	5/8"	---	---	600-AL-SS	5/8"
8"	800-AL-AL <sup>1</sup>	1-1/8"	---	---	---	---

<sup>1</sup> Part is produced as a welded fabrication

NOTE: For flange dimensions, diagrams, and additional information, please reference dixonvalve.com.



## Adapter x 150# ANSI Flange

### Feature

- Global product made to Dixon® specifications

Size	316 Stainless Steel Part #	Flange Thickness
2"	200-AL-SSANSI	3/4"
3"	300-AL-SSANSI	15/16"

NOTE: For flange dimensions, diagrams, and additional information, please reference dixonvalve.com.



## Dixon Coupler x 150# Flange

### Feature

- Nitrile rubber gasket standard, other gaskets available on pages 68 - 71

Size	356T6 Aluminum Part #	Flange Thick	316 Stainless Steel Part #	Flange Thick.
1"	---	---	100-DL-SS	21/32"
1-1/2"	---	---	150-DL-SS	25/32"
2"	200-DL-AL	3/4"	200-DL-SS	7/16"
3"	300-DL-AL	15/16"	300-DL-SS	7/16"
4"	400-DL-AL	15/16"	400-DL-SS	7/16"
6"	600-DL-AL	1"	600-DL-SS	5/8"
8"	800-DL-AL <sup>1</sup>	1-1/8"	---	---

<sup>1</sup> Part is produced as a welded fabrication

NOTE: For flange dimensions, diagrams, and additional information, please reference dixonvalve.com.



## EZ Boss-Lock Coupler x 150# Flange

### Feature

- Nitrile rubber gasket standard, other gaskets available on pages 68 - 71

Size	316 Stainless Steel Part #	Flange Thickness
1"	RDL100EZ <sup>1</sup>	9/16"
1-1/2"	RDL150EZ <sup>1</sup>	11/16"
2"	RDL200EZ	7/16"
3"	RDL300EZ <sup>1</sup>	7/16"
4"	RDL400EZ <sup>1</sup>	7/16"
6"	RDL600EZ <sup>1</sup>	1"

<sup>1</sup> Parts are produced as a welded fabrication

NOTE: For flange dimensions, diagrams, and additional information, please reference dixonvalve.com.



B

### Dixon® Coupler Socket Weld to Schedule 40 Pipe

**Features**

- Not all configurations are stocked
- Boss-Lock versions are also available; consult Dixon for pricing and availability
- CAD models are for reference only; consult Dixon for specific dimensions
- Final weld preparation, as with all weld fittings, is the responsibility of the welder



Size	Bore	356T6 Aluminum Part #	316 Stainless Steel Part #
3/4"	1.065	---	75DWSPSS
1"	1.330	100DWSPAL	100DWSPSS
1-1/2"	1.915	150DWSPAL	150DWSPSS
2"	2.390	200DWSPAL	200DWSPSS
3"	3.530	300DWSPAL	300DWSPSS
4"	4.530	400DWSPAL	400DWSPSS
5"	5.562	500DWSPAL	500DWSPSS
6"	6.655	600DWSPAL	600DWSPSS
8"	8.711	800DWSPAL <sup>1</sup>	---

<sup>1</sup> Dixon and Boss-Lock cam & groove couplings do not interchange in the 8" size. The 8" Dixon design has 4 cam arms.



### Dixon Coupler Butt Weld to Schedule 40 Pipe/Socket Weld to Nominal Tubing



Size	Bore	356T6 Aluminum Part #	316 Stainless Steel Part #
3/4"	.765	---	75DWPSTSS
1"	1.015	---	100DWPSTSS
1-1/2"	1.515	150DWPSTAL	150DWPSTSS
2"	2.015	200DWPSTAL	200DWPSTSS
3"	3.015	300DWPSTAL	300DWPSTSS
4"	4.015	400DWPSTAL	400DWPSTSS
5"	5.015	500DWPSTAL	---
6"	6.020	600DWPSTAL	---

### EZ Boss-Lock Coupler Socket Weld to Schedule 40 Pipe

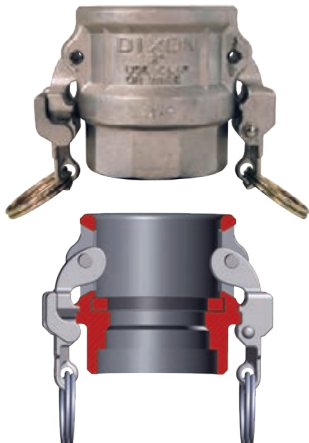

Size	Bore	316 Stainless Steel Part #
3/4"	1.065	RDWSP075EZ
1"	1.330	RDWSP100EZ
1-1/2"	1.915	RDWSP150EZ
2"	2.390	RDWSP200EZ
3"	3.530	RDWSP300EZ
4"	4.530	RDWSP400EZ
6"	6.655	RDWSP600EZ



## EZ Boss-Lock Coupler Butt Weld to Schedule 40 Pipe / Socket Weld to Nominal Tubing

**Feature**

- Nitrile rubber gaskets standard, other gaskets available on pages 68 - 71

Size	Bore	316 Stainless Steel Part #
3/4"	.765	RDWBPST075EZ
1"	1.015	RDWBPST100EZ
1-1/2"	1.515	RDWBPST150EZ
2"	2.015	RDWBPST200EZ
3"	3.015	RDWBPST300EZ
4"	4.015	RDWBPST400EZ
6"	6.020	RDWBPST600EZ

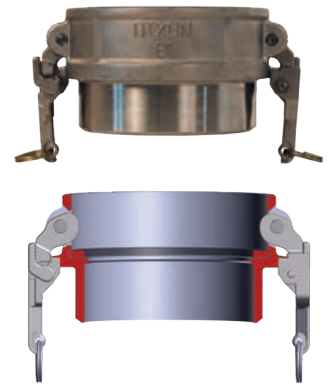

**B**

## Adapter Socket Weld to Schedule 40 Pipe

**Feature**

- Not all configurations are stocked

Size	Bore	356T6 Aluminum Part #	316 Stainless Steel Part #
3/4"	1.065	---	75AWSPSS
1"	1.330	---	100AWSPSS
1-1/2"	1.915	150AWSPAL	150AWSPSS
2"	2.390	200AWSPAL	200AWSPSS
3"	3.530	300AWSPAL	300AWSPSS
4"	4.530	400AWSPAL	400AWSPSS
5"	5.593	500AWSPAL	500AWSPSS
6"	6.655	600AWSPAL	600AWSPSS
8" DIX	8.711	800AWSPAL <sup>1</sup>	---
8" BL	8.711	801AWSPAL <sup>1</sup>	---



<sup>1</sup> Dixon® and Boss-Lock cam & groove couplings do not interchange in the 8" size.  
NOTE: Final weld preparation, as with all weld fittings, is the responsibility of the welder. 

## Adapter Butt Weld to Schedule 40 Pipe/Socket Weld to Nominal Tubing

Size	Bore	356T6 Aluminum Part #	316 Stainless Steel Part #
3/4"	.765	---	75AWBPSTSS
1"	1.015	---	100AWBPSTSS
1-1/2"	1.515	150AWBPSTAL	150AWBPSTSS
2"	2.015	200AWBPSTAL	200AWBPSTSS
3"	3.015	300AWBPSTAL	300AWBPSTSS
4"	4.015	400AWBPSTAL	400AWBPSTSS
5"	5.015	500AWBPSTAL	500AWBPSTSS
6"	6.020	600AWBPSTAL	600AWBPSTSS
8" BL	8.035	801AWBPSTAL <sup>1</sup>	---



<sup>1</sup> Dixon and Boss-Lock cam & groove couplings do not interchange in the 8" size 

B

### Adapter x Female NPSM



**Application**

- Used in the delivery of dry goods

**Features**

- Cork nitrile rubber gaskets are standard in threaded end
- Pressure rating is based on the seal of the mating part, see ratings on page 20
- Replacement gasket; 400GAGFI

Size	356T6 Aluminum Part #
4"	400-AS-AL

### Boss-Lock Coupler x Female NPSM



**Features**

- Nitrile rubber gasket standard, other gaskets available on pages 68 - 71
- All Boss-Lock couplers are supplied with pull-ring safety clips

Size	356T6 Aluminum Part #
4"	ADS400

### Dixon® Coupler x Adapter Wye



**Feature**

- Nitrile rubber gasket standard, other gaskets available on pages 68 - 71

Size	356T6 Aluminum Part #
2"	200YDAAAL
4"	400YDAAAL <sup>1</sup>

<sup>1</sup> Parts are produced as a welded fabrication.

### Cam & Groove Hydrant Adapters



**Features**

- Pin lugs allow for easy connection using standard spanner and hydrant wrenches on pages 828 - 831
- Supplied with a nitrile rubber washer in the threaded end

Female NST (NH) Thread	Male Adapter	Brass Part #	Aluminum Part #
1-1/2"	1-1/2"	HA1515ADP	AHA1515ADP
2-1/2"	2-1/2"	HA2525ADP	AHA2525ADP

### Replacement Washers



I.D.	O.D.	Thickness	Nitrile Rubber Part #
1-9/16"	2-1/16"	1/8"	SW150
2-9/16"	3-3/16"	3/16"	SW250

NOTE: All adapters are made to approved Dixon specifications.

## Boss-Lock Coupler x Tube with 45° Cut

**Application**

- For use on trailer relief valves

**Features**

- Butt weld to tubing
- Nitrile rubber gaskets standard, other gaskets available on pages 68 - 71
- All Boss-Lock couplers are supplied with pull-ring safety clips

Size	356T6 Aluminum Part #
2"	AC200TUBE



**B**

## In-Line Sight Glasses

**Application**

- Designed for dry bulk transfer hose

**Feature**

- Not intended for liquid service. For dry bulk transfer *only*.



**Materials**

- Body: aluminum
- Seals: nitrile rubber
- Sight glass: acrylic
- Hardware: stainless steel
- Cam arms (where applicable): bronze

### Coupler x Adapter

Size	Aluminum Part #
3" x 3"	3533CA
3" x 4"	3534CA
4" x 3"	3543CA
4" x 4"	3544CA



### Adapter x Adapter

Size	Aluminum Part #
3" x 3"	3533AA
3" x 4"	3534AA
4" x 4"	3544AA



### Coupler x Coupler

Size	Aluminum Part #
3" x 3"	3533CC
4" x 3"	3543CC
4" x 4"	3544CC



## Dixon® Cam & Groove Handles

B

### Features

- Pull rings are standard on sizes 1-1/4" thru 6", optional on other sizes
- Domestic Dixon standard handle assemblies are only to be used with standard Dixon parts (not global), handles do not interchange with other manufacturers' handles or couplers



### Materials

- Stainless steel pins standard with all assemblies
- Roll pins are 302 stainless; solid pins are 303 stainless

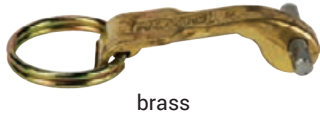

brass



316 sintered stainless steel



316 investment stainless steel

Coupler Size	Description	Brass Part #	316 Sintered Stainless Steel Part #
1/2"	cam arm and pin	---	50-HP-SP
3/4"	cam arm and pin	---	75-HP-SP
1"	cam arm and pin	---	100-HP-SP
1-1/4" - 2-1/2"	cam arm, ring, and pin	200-HRP-BR	200-HRP-SP
3" - 5"	cam arm, ring, and pin	300-HRP-BR	300-HRP-SP
6"	cam arm, ring, and pin	600-HRP-BR	---
8"	cam arm and pin	800-HNP-BR	---

Coupler Size	Description	316 Investment Stainless Steel Part #
2"	cam arm, ring and pin	200-HSCR-SP
3"	cam arm, ring and pin	300-HSCR-SP
6"	cam arm, ring and pin	600-HRP-SI

## Dixon Cam & Groove Locking Handles for Dust Caps

### Features

- Dixon locking handles are only to be used with standard Dixon parts (not global), handles do not interchange with other manufacturers' handles or couplers
- Not supplied with pins



200-LH-SI



300-LH-BR

Coupler Size	Hole Diameter	Brass Part #	316 Investment Stainless Steel Part #
2"	9/32"	200-LH-BR	200-LH-SI
3"	5/16"	300-LH-BR	300-LH-SI
4"	3/8"	400-LH-BR	400-LH-SI

## Boss-Lock Cam & Groove Handles

### Feature

- Boss-Lock handles should only be used with Boss-Lock parts, handles do not interchange with other manufacturers' handles or couplers



IHSC152



IH6

Coupler Size	Brass Part #	316 Investment Stainless Steel Part #	Plated Iron Part #
3/4" - 1"	BHSC175	RHSC175	---
1-1/4" - 2-1/2"	BHSC152	RHSC152	IHSC152
3" and 4"	BHSC34	RHSC34	IHSC34

Coupler Size	Brass Part #	Plated Iron Part #
6" and 8"	BH6	IH6

### EZ Boss-Lock Cam & Groove Handles

**Materials**

- Investment cast stainless steel cam arm and lever
- 316 stainless steel spring
- Stainless steel pin, washer; plated carbon steel pull ring

Coupler Size	Investment Cast Stainless Steel Part #
3/4" - 1"	RHEZ175
1-1/4" - 2-1/2"	RHEZ152
3" - 5"	RHEZ34
6" and 8"	RHEZ6



**B**

### EZ Boss-Lock Cam & Groove Paddle Handle

**Materials**

- Investment cast stainless steel cam arm and lever
- 316 stainless steel spring
- Stainless steel pin, washer

Coupler Size	Investment Cast Stainless Steel Part #
3" - 5"	RHEZ34PAD



Under no circumstances should the EZ Boss-Lock cam arms be used on any fitting not specifically produced for their use. The aluminum, brass, and iron are made from sand castings. To ensure proper functioning of the EZ Boss-Lock cam arm assemblies, we sort the castings to ensure there is sufficient length and orientation on the lugs on the main casting to engage the lever. We also buff or grind the rougher sand cast surface to ensure that the lever will move freely. The EZ Boss-Lock cam arms cannot be retrofitted onto existing aluminum, brass, or plated iron Boss-Lock already in service.



### Dixon® Coupling Paddle Handles

**Features**

- Dixon paddle handles are only to be used with standard Dixon parts (not global), handles do not interchange with other manufacturers' handles or couplers
- Not supplied with pins



Coupler Size	Brass Part #	316 Investment Cast Stainless Steel Part #
3" and 4"	300H-PADBR	300H-PADSS



316 investment cast stainless steel



brass

B

### Cam & Groove Gasket Dimensions

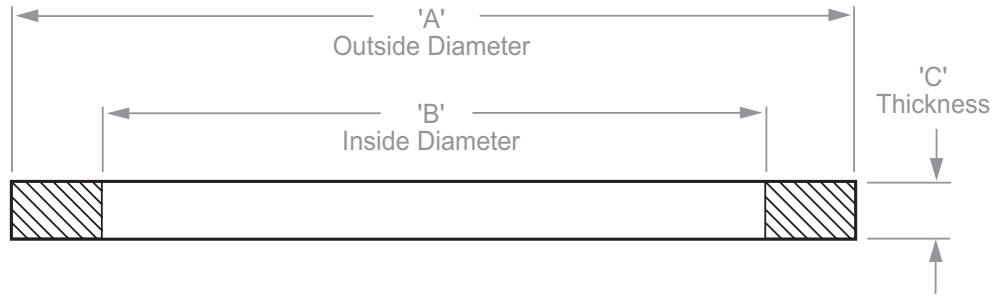

**Features**

- Nominal dimensions for elastomeric cam & groove gaskets are listed
- I.D.s of the PTFE envelope gaskets and the PTFE accordion gaskets are 1/16" smaller than the I.D.s for the elastomeric gaskets shown below
- Thickness of PTFE accordion gaskets may vary from chart below

Size	Part #	Dimensions		
		A	B	C
1/2"	50-G <sup>1</sup>	1-1/32"	11/16"	.156"
3/4"	75-G	1-3/8"	7/8"	.218"
1"	100-G	1-9/16"	1-1/16"	.250"
1-1/4"	125-G	1-15/16"	1-23/64"	.250"
1-1/2"	150-G	2-3/16"	1-5/8"	.250"
2"	200-G	2-5/8"	2"	.250"
2-1/2"	250-G	3-1/8"	2-3/8"	.250"
3"	300-G	3-23/32"	3"	.250"
4"	400-G	4-7/8"	4"	.250"
5"	500-G	5-15/16"	4-7/8"	.250"
6"	600-G	7-1/16"	6"	.250"
8"	800-G <sup>1</sup>	9-5/16"	8-1/8"	.343"

<sup>1</sup> No interchange standard exists for the 1/2", 5", and 8" fittings. Generally, these sizes do not interchange with other manufacturers' products. As such, the gaskets in these sizes are not suitable for use in other manufacturers' couplings.

### Cam & Groove Gasket Color Codes



Gasket Code <sup>1</sup>	Material	Color	Color code stripes (appear on the O.D. of the gasket or filler)
-BU	Nitrile rubber (standard in all metal fittings)	black	1 blue
-BF	Nitrile rubber (formulated for fuel service)	black	1 green
-VI	FKM-A	green	none
-VIA	FKM-A	black	1 yellow
-THK	Extra Thick Nitrile rubber	black	2 blue
-EPR	Ethylene Propylene	black	1 white
-NE	Neoprene	black	1 red
-WNE	White Neoprene, FDA approved material	white	none
-WB	White nitrile rubber, FDA approved material	white	blue
-SIL	Silicone	red	none
-TF	PTFE (TFE) envelope with nitrile rubber filler	white / black	1 blue
TFVI	PTFE (TFE) envelope with FKM filler	white / black	1 yellow
TFWB	PTFE (TFE) envelope with White nitrile rubber filler, FDA approved materials	white / white	blue
TFEP	PTFE (TFE) envelope with Ethylene Propylene filler	white / black	1 white stripe
-TES	PTFE (FEP) encapsulated Silicone core, FDA approved materials	translucent / red	none
-TEV	PTFE (FEP) encapsulated FKM core	translucent / black	none
TFACC	PTFE (TFE) accordion, FDA approved materials	white	none

<sup>1</sup> Part number suffix

NOTE: Since other manufacturers' coding systems vary, this chart should not be used as a reference in identifying gaskets of unknown origin.



### Cam & Groove Gaskets

Size	Nitrile Rubber Part #	Green FKM-A Part #	Black FKM-A Part #
1/2"	50-G-BU	50-G-VI	50-G-VIA
3/4"	75-G-BU	75-G-VI	75-G-VIA
1"	100-G-BU	100-G-VI	100-G-VIA
1-1/4"	125-G-BU	125-G-VI	125-G-VIA
1-1/2"	150-G-BU	150-G-VI	150-G-VIA
2"	200-G-BU	200-G-VI	200-G-VIA
2-1/2"	250-G-BU	250-G-VI	250-G-VIA
3"	300-G-BU	300-G-VI	300-G-VIA
4"	400-G-BU	400-G-VI	400-G-VIA
5"	500-G-BU	500-G-VI	500-G-VIA
6"	600-G-BU	600-G-VI	600-G-VIA
8"	800-G-BU	800-G-VI	800-G-VIA

Size	Extra Thick Nitrile Rubber Part #	Ethylene Propylene Part #
3/4"	---	75-G-EPR
1"	100GTHK	100-G-EPR
1-1/4"	125GTHK	125-G-EPR
1-1/2"	150GTHK	150-G-EPR
2"	200GTHK	200-G-EPR
2-1/2"	250GTHK	250-G-EPR
3"	300GTHK	300-G-EPR
4"	400GTHK	400-G-EPR
6"	600GTHK	---

Size	Neoprene Part #	Extra Thick Neoprene Part #	White Neoprene <sup>1</sup> Part #
3/4"	75-G-NE	---	---
1"	100-G-NE	---	---
1-1/4"	125-G-NE	---	---
1-1/2"	150-G-NE	---	150-G-WNE
2"	200-G-NE	200-G-NETHK	200-G-WNE
2-1/2"	250-G-NE	---	---
3"	300-G-NE	---	300-G-WNE
4"	400-G-NE	---	400-G-WNE
5"	---	---	500-G-WNE
6"	---	---	600-G-WNE

<sup>1</sup> White neoprene gaskets contain FDA approved materials

Size	White Nitrile Rubber <sup>1</sup> Part #	Silicone Part #
1"	---	100-G-SIL
1-1/2"	---	150-G-SIL
2"	200-G-WB	200-G-SIL
2-1/2"	---	250-G-SIL
3"	300-G-WB	300-G-SIL
4"	400-G-WB	400-G-SIL
5"	500-G-WB	---

<sup>1</sup> White nitrile rubber gaskets contain FDA approved materials



nitrile rubber



FKM



FKM-A



extra thick nitrile rubber



ethylene propylene



neoprene



white neoprene



white nitrile rubber



silicone

**B**

**Fuel Gaskets**

**B**



Size	Material	Part #
1-1/2"	nitrile rubber	150-G-BF
2"	nitrile rubber	200-G-BF
3"	nitrile rubber	300-G-BF
4"	nitrile rubber	400-G-BF
3"	extra thick nitrile rubber	300GTHKBF
4"	extra thick nitrile rubber	400GTHKBF

**Cam & Groove Envelope Gaskets**

**Feature**

- Maximum operating temperatures for specific chemicals may be lower; contact Dixon® for specific recommendations

**Approval**

- PTFE white nitrile rubber filler (TFWB) contains FDA approved materials

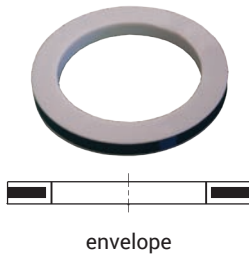

Size	PTFE (TFE) with Nitrile Rubber filler Part #	PTFE (TFE) with FKM filler Part #
1/2"	50-G-TF	50-G-TF-VI
3/4"	75-G-TF	75-G-TF-VI
1"	100-G-TF	100GTFVI
1-1/4"	125-G-TF	125GTFVI
1-1/2"	150-G-TF	150GTFVI
2"	200-G-TF	200GTFVI
2-1/2"	250-G-TF	250GTFVI
3"	300-G-TF	300GTFVI
4"	400-G-TF	400GTFVI
6"	600-G-TF	600GTFVI

Size	PTFE (TFE) with white Nitrile Rubber filler Part #	PTFE (TFE) with Ethylene Propylene filler Part #
1-1/2"	---	150GTFEP
2"	200GTFWB	200GTFEP
3"	300GTFWB	300GTFEP
4"	400GTFWB	---
5"	500GTFWB	---

NOTE: The torque (force) required to close the handles on a pair of cam & groove fittings will vary according to the gasket chosen. Due to the nature of the PTFE material, the various PTFE gasket designs will require the most torque, increasing as you go from envelope to encapsulated, and finally, accordion.



## Cam & Groove Encapsulated Gaskets

### Specifications

- Encapsulated gasket pressure ratings are reduced to **125 PSI** for 3/4" - 4" at ambient temperature **70°F (21°C)**
- PTFE encapsulated FKM (TEV) gaskets - maximum operating temperature **200°F (93°C)**
- PTFE encapsulated silicone (TES) gaskets - maximum operating temperature **225°F (107°C)**
- Maximum operating temperatures for specific chemicals may be lower; contact Dixon® for specific recommendations

### Approval

- PTFE encapsulated silicone (TES) gaskets contain FDA approved materials

Size	PTFE (FEP) Encapsulated Silicone Part #	PTFE (FEP) Encapsulated FKM Part #
1/2"	50-G-TES	---
3/4"	75-G-TES	75-G-TEV
1"	100-G-TES	100-G-TEV
1-1/4"	125-G-TES	125-G-TEV
1-1/2"	150-G-TES	150-G-TEV
2"	200-G-TES	200-G-TEV
2-1/2"	250-G-TES	250-G-TEV
3"	300-G-TES	300-G-TEV
4"	400-G-TES	400-G-TEV



**B**

## Cam & Groove Accordion Gaskets

### Features

- PTFE accordion gaskets (TFACC) are recommended for use with viscous (thick) fluids only 
- Maximum operating temperatures for specific chemicals may be lower; contact Dixon for specific recommendations

Size	PTFE (TFE) Part #
3/4"	75GTFACC
1"	100GTFACC
1-1/4"	125GTFACC
1-1/2"	150GTFACC
2"	200GTFACC
3"	300GTFACC

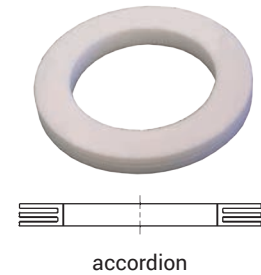

NOTE: The torque (force) required to close the handles on a pair of cam & groove fittings will vary according to the gasket chosen. Due to the nature of the PTFE material, the various PTFE gasket designs will require the most torque, increasing as you go from envelope to encapsulated, and finally, accordion.

### Witches Hat Strainers

B



**Features**

- Used with female cam & groove couplings
- Pre-attached nitrile rubber gasket

Size	304 Stainless Steel Part #
3"	WH300-A
4"	WH400-A

### Gaskets for Witches Hat Strainers



Size	Nitrile Rubber Gasket Part #
3"	WH300-G
4"	WH400-G

### Disk Strainers

**Feature**

- Threads into bottom of female NPT fitting to protect equipment from large contaminants



Size	Hole Size	6061T6 Aluminum Part #	304 Investment Cast Stainless Steel Part #
2"	1/4"	SDA200	SDS200
3"		SDA300	SDS300
4"		SDA400	SDS400

### Pull Ring Safety Clips for Boss-Lock



Coupler Size	Carbon Steel Part #	316 Stainless Steel Part #
3/4" - 1"	---	100PRSCSS
1-1/4" - 2-1/2"	200PRSCCS	200PRSCSS
3" and 4"	300PRSCCS	300PRSCSS

### Pull Rings



304 Stainless Steel Part #
R200SS

### Sash Chain with Pull Rings

**Materials**

- Brass chain, plated steel pull ring



Length	Part #
4-1/2"	J125
6-1/2"	J150
8-1/2"	J300
12-3/4"	J500

### Abrasion Resistant Inserts

**Features**

- Extends the life of adapters when transferring proppant to storage tanks
- Available for multiple adapters and multiple coupler materials

Description	UHMW Polyethylene Part #
to be used with 400-A-AL, 400-A-BR, 400-A-MI, 400-A-SS	400-A-INSERT
to be used with 400-C-AL	400-C-INSERTAL
to be used with 400-C-MI	400-C-INSERTMI



400-A-INSERT



400-C-INSERTAL

**B**

### Clip for Boss-Lock Couplings

**Feature**

- .072 stainless steel wire

Stainless Steel Part #
AC7



### Clip Assembly

**Features**

- For use with Boss-Lock couplings
- Includes pull ring, chain, and AC3 clip

CarbonSteel Part #
BLCA152CS



### Jack Chain with S-Hook

Length	Material	Part #	Optional Qty
6"	brass	CH-B-6	10
12"	brass	CH-B-12	10
24"	brass	CH-B-24	---
12"	carbon steel	CH-C-12	10
6"	stainless	CH-SS-6	10
12"	stainless	CH-SS-12	10
24"	stainless	CH-SS-24	10



### Locking Cam Arm Velcro® Straps

**Application**

- Use with cam & groove couplers to prevent spills, secure from damage, and hold in place during transport

**Features**

- Used on the female end of a cam & groove coupler
- High visibility orange hook and loop with metal buckle provides strength, durability, and long life

**Specification**

- Temperature range: -70°F to 200°F (-57°C to 93°C)

Length	Used On	Part #
12"	fits up to 1-1/2" coupler	CVS12
18"	fits up to 3" coupler	CVS18
24"	fits up to 5" coupler	CVS24
36"	fits up to 8" coupler	CVS36



coupler sold separately

B

### Lanyards with Clip for Boss-Lock Couplings



**Materials**

- Clip: carbon steel
- Lanyard: nylon

Coupler Size	Part #
3/4" - 1"	ACL4
1-1/4" - 4"	ACL2
6"	ACL3

### PVC Coated Lanyards

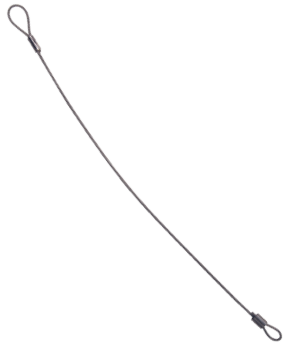

**Feature**

- One end factory crimped, one end uncrimped for field installation

**Material**

- PVC coated carbon steel with aluminum crimp sleeves

Length	Part #
15"	CAL15
25"	CAL25

### Lanyard for Boss-Lock Couplings



**Feature**

- Breaking strength: 160 lbs.

Overall Length	304 Stainless Part #
7"	LR7

## Global Type A Adapters

### Adapter x Female NPT

#### Features

- Interchanges with all products produced to A-A-59326D
- Pressure rating for adapters is based on the seal of the mating part

Size	A380 Permanent Mold Aluminum Part #	ASTMC38000 Forged Brass Part #
1/2"	G50-A-AL <sup>1</sup>	G50-A-BR <sup>1</sup>
3/4"	G75-A-AL	G75-A-BR
1"	G100-A-AL	G100-A-BR
1-1/4"	G125-A-AL	G125-A-BR
1-1/2"	G150-A-AL	G150-A-BR
2"	G200-A-AL	G200-A-BR
2-1/2"	G250-A-AL	G250-A-BR
3"	G300-A-AL	G300-A-BR
4"	G400-A-AL	G400-A-BR
5"	G500-A-AL <sup>1</sup>	G500-A-BR <sup>1</sup>
6"	G600-A-AL	---
8"	G800-A-AL <sup>1</sup>	---

Size	316 Investment Cast Stainless Steel Part #
1/2"	G50-A-SS <sup>1</sup>
3/4"	G75-A-SS
1"	G100-A-SS
1-1/4"	G125-A-SS
1-1/2"	G150-A-SS
2"	G200-A-SS
2-1/2"	G250-A-SS
3"	G300-A-SS
4"	G400-A-SS
6"	G600-A-SS



ASTMC38000 forged brass

<sup>1</sup> No standard exists for the 1/2", 5", and 8", and generally these sizes do not interchange with other manufacturers' products.

## Global Type B Couplers Coupler x Male NPT

**B**

**Features**

- Interchanges with all products produced to A-A-59326D
- Nitrile rubber seals standard



A380 permanent mold aluminum

Size	A380 Permanent Mold A with Brass Handles Part #	ASTMC38000 Forged Brass Part #
1/2"	G50-B-AL <sup>1, 2</sup>	G50-B-BR <sup>1, 2</sup>
3/4"	G75-B-AL <sup>2</sup>	G75-B-BR <sup>2</sup>
1"	G100-B-AL <sup>2</sup>	G100-B-BR <sup>2</sup>
1-1/4"	G125-B-AL	G125-B-BR
1-1/2"	G150-B-AL	G150-B-BR
2"	G200-B-AL	G200-B-BR
2-1/2"	G250-B-AL	G250-B-BR
3"	G300-B-AL	G300-B-BR
4"	G400-B-AL	G400-B-BR
5"	G500-B-AL <sup>1</sup>	G500-B-BR <sup>1</sup>
6"	G600-B-AL	---

Size	316 Investment Cast Stainless Steel Part #	A380 Permanent Mold Aluminum with Investment Stainless Handles Part #
1/2"	G50-B-SS <sup>1</sup>	---
3/4"	G75-B-SS	---
1"	G100-B-SS	---
1-1/4"	G125-B-SS	---
1-1/2"	G150-B-SS	G150-B-ALSI
2"	G200-B-SS	G200-B-ALSI
2-1/2"	G250-B-SS	---
3"	G300-B-SS	G300-B-ALSI
4"	G400-B-SS	G400-B-ALSI
6"	G600-B-SS	---

<sup>1</sup> No standard exists for the 1/2", 5", and 8", and generally these sizes do not interchange with other manufacturers' products.  
<sup>2</sup> Supplied with stainless steel handles

## Global Type C Couplers

### Coupler x Hose Shank

B

#### Features

- Interchanges with all products produced to A-A-59326D
- Nitrile rubber seals are standard

Size	A380 Permanent Mold Aluminum with Brass Handles Part #	ASTMC38000 Forged Brass Part #
1/2"	G50-C-AL <sup>1,2</sup>	G50-C-BR <sup>1,2</sup>
3/4"	G75-C-AL <sup>2</sup>	G75-C-BR <sup>2</sup>
1"	G100-C-AL <sup>2</sup>	G100-C-BR <sup>2</sup>
1-1/4"	G125-C-AL	G125-C-BR
1-1/2"	G150-C-AL	G150-C-BR
2"	G200-C-AL	G200-C-BR
2-1/2"	G250-C-AL	G250-C-BR
3"	G300-C-AL	G300-C-BR
4"	G400-C-AL	G400-C-BR
5"	G500-C-AL <sup>1</sup>	G500-C-BR <sup>1</sup>
6"	G600-C-AL	---
8"	G800-C-AL <sup>1</sup>	---

Size	316 Investment Cast Stainless Steel Part #	A380 Permanent Mold Aluminum with Investment Stainless Handles Part #
1/2"	G50-C-SS <sup>1</sup>	---
3/4"	G75-C-SS	---
1"	G100-C-SS	---
1-1/4"	G125-C-SS	---
1-1/2"	G150-C-SS	G150-C-ALSI
2"	G200-C-SS	G200-C-ALSI
2-1/2"	G250-C-SS	---
3"	G300-C-SS	G300-C-ALSI
4"	G400-C-SS	G400-C-ALSI
6"	G600-C-SS	---



316 investment cast  
stainless steel

<sup>1</sup> No standard exists for the 1/2", 5", and 8", and generally these sizes do not interchange with other manufacturers' products.

<sup>2</sup> Supplied with stainless steel handles

NOTE: See page 7 for Global Crimp Type C couplers

## Global Type D Couplers

## Coupler x Female NPT

B

## Features

- Interchanges with all products produced to A-A-59326D
- Nitrile rubber seals are standard



316 investment cast stainless steel

Size	A380 Permanent Mold Aluminum with Brass Handles Part #	ASTMC38000 Forged Brass Part #
1/2"	G50-D-AL <sup>1,2</sup>	G50-D-BR <sup>1,2</sup>
3/4"	G75-D-AL <sup>2</sup>	G75-D-BR <sup>2</sup>
1"	G100-D-AL <sup>2</sup>	G100-D-BR <sup>2</sup>
1-1/4"	G125-D-AL	G125-D-BR
1-1/2"	G150-D-AL	G150-D-BR
2"	G200-D-AL	G200-D-BR
2-1/2"	G250-D-AL	G250-D-BR
3"	G300-D-AL	G300-D-BR
4"	G400-D-AL	G400-D-BR
5"	G500-D-AL <sup>1</sup>	G500-D-BR <sup>1</sup>
6"	G600-D-AL	---

Size	316 Investment Cast Stainless Steel Part #	A380 Permanent Mold Aluminum with Investment Stainless Handles Part #
1/2"	G50-D-SS <sup>1</sup>	---
3/4"	G75-D-SS	---
1"	G100-D-SS	---
1-1/4"	G125-D-SS	---
1-1/2"	G150-D-SS	G150-D-ALSI
2"	G200-D-SS	G200-D-ALSI
2-1/2"	G250-D-SS	---
3"	G300-D-SS	G300-D-ALSI
4"	G400-D-SS	G400-D-ALSI
6"	G600-D-SS	---

<sup>1</sup> No standard exists for the 1/2" and 5", and generally these sizes do not interchange with other manufacturers' products.

<sup>2</sup> Stainless steel handles



## Global Type E Adapters

### Adapter x Hose Shank

#### Features

- Interchanges with all products produced to A-A-59326D
- Pressure rating for adapters is based on the seal of the mating part

Size	A380 Permanent Mold Aluminum Part #	ASTMC38000 Forged Brass Part #	316 Investment Cast Stainless Steel Part #
1/2"	G50-E-AL <sup>1</sup>	G50-E-BR <sup>1</sup>	G50-E-SS <sup>1</sup>
3/4"	G75-E-AL	G75-E-BR	G75-E-SS
1"	G100-E-AL	G100-E-BR	G100-E-SS
1-1/4"	G125-E-AL	G125-E-BR	G125-E-SS
1-1/2"	G150-E-AL	G150-E-BR	G150-E-SS
2"	G200-E-AL	G200-E-BR	G200-E-SS
2-1/2"	G250-E-AL	G250-E-BR	G250-E-SS
3"	G300-E-AL	G300-E-BR	G300-E-SS
4"	G400-E-AL	G400-E-BR	G400-E-SS
5"	G500-E-AL <sup>1</sup>	G500-E-BR <sup>1</sup>	---
6"	G600-E-AL	---	G600-E-SS
8"	G800-E-AL <sup>1</sup>	---	---



A380 permanent mold aluminum

<sup>1</sup> No standard exists for the 1/2", 5" and 8", and generally these sizes do not interchange with other manufacturers' products.

## Global Type F Adapters

### Adapter x Male NPT

#### Features

- Interchanges with all products produced to A-A-59326D
- Pressure rating for adapters is based on the seal of the mating part

Size	A380 Permanent Mold Aluminum Part #	ASTMC38000 Forged Brass Part #	316 Investment Cast Stainless Steel Part #
1/2"	G50-F-AL <sup>1</sup>	G50-F-BR <sup>1</sup>	G50-F-SS <sup>1</sup>
3/4"	G75-F-AL	G75-F-BR	G75-F-SS
1"	G100-F-AL	G100-F-BR	G100-F-SS
1-1/4"	G125-F-AL	G125-F-BR	G125-F-SS
1-1/4"	G150-F-AL	G150-F-BR	G150-F-SS
2"	G200-F-AL	G200-F-BR	G200-F-SS
2-1/2"	G250-F-AL	G250-F-BR	G250-F-SS
3"	G300-F-AL	G300-F-BR	G300-F-SS
4"	G400-F-AL	G400-F-BR	G400-F-SS
5"	G500-F-AL <sup>1</sup>	G500-F-BR <sup>1</sup>	---
6"	G600-F-AL	---	G600-F-SS



ASTMC38000 forged brass

<sup>1</sup> No standard exists for the 1/2" and 8", and generally these sizes do not interchange with other manufacturers' products.

**B**

### Global Type DC Dust Caps

**Features**

- Interchanges with all products produced to A-A-59326D
- Nitrile rubber seals are standard
- Dust caps and dust plugs are not to be used in pressure applications for safety and environmental reasons



A380 permanent mold aluminum

Size	A380 Permanent Mold Aluminum with Brass Handles Part #	ASTMC38000 Forged Brass Part #
1/2"	G50-DC-AL <sup>1,2</sup>	G50-DC-BR <sup>1,2</sup>
3/4"	G75-DC-AL <sup>2</sup>	G75-DC-BR <sup>2</sup>
1"	G100-DC-AL <sup>2</sup>	G100-DC-BR <sup>2</sup>
1-1/4"	G125-DC-AL	G125-DC-BR
1-1/2"	G150-DC-AL	G150-DC-BR
2"	G200-DC-AL	G200-DC-BR
2-1/2"	G250-DC-AL	G250-DC-BR
3"	G300-DC-AL	G300-DC-BR
4"	G400-DC-AL	G400-DC-BR
5"	G500-DC-AL <sup>1</sup>	G500-DC-BR <sup>1</sup>
6"	G600-DC-AL	---

Size	316 Investment Cast Stainless Steel Part #	A380 Permanent Mold Aluminum with Investment Stainless Handles Part #
1/2"	G50-DC-SS <sup>1</sup>	---
3/4"	G75-DC-SS	---
1"	G100-DC-SS	---
1-1/4"	G125-DC-SS	---
1-1/2"	G150-DC-SS	G150-DC-ALSI
2"	G200-DC-SS	G200-DC-ALSI
2-1/2"	G250-DC-SS	---
3"	G300-DC-SS	G300-DC-ALSI
4"	G400-DC-SS	G400-DC-ALSI
6"	G600-DC-SS	---

<sup>1</sup> No standard exists for the 1/2" and 5", and generally these sizes do not interchange with other manufacturers' products.

<sup>2</sup> Stainless steel handles

### Global Type DP Dust Plugs

**Features**

- Interchanges with all products produced to A-A-59326D
- Nitrile rubber seals are standard
- Dust caps and dust plugs are not to be used in pressure applications for safety and environmental reasons



A380 permanent mold aluminum

Size	A380 Permanent Mold Aluminum Part #	ASTMC38000 Forged Brass Part #	316 Investment Cast Stainless Steel Part #
1/2"	G50-DP-AL <sup>1</sup>	G50-DP-BR <sup>1</sup>	G50-DP-SS <sup>1</sup>
3/4"	G75-DP-AL	G75-DP-BR	G75-DP-SS
1"	G100-DP-AL	G100-DP-BR	G100-DP-SS
1-1/4"	G125-DP-AL	G125-DP-BR	G125-DP-SS
1-1/2"	G150-DP-AL	G150-DP-BR	G150-DP-SS
2"	G200-DP-AL	G200-DP-BR	G200-DP-SS
2-1/2"	G250-DP-AL	G250-DP-BR	G250-DP-SS
3"	G300-DP-AL	G300-DP-BR	G300-DP-SS
4"	G400-DP-AL	G400-DP-BR	G400-DP-SS
5"	G500-DP-AL <sup>1</sup>	G500-DP-BR <sup>1</sup>	---
6"	G600-DP-AL	---	G600-DP-SS

<sup>1</sup> No standard exists for the 1/2" and 5", and generally these sizes do not interchange with other manufacturers' products.

## Global Type DA Jump Size Couplings

### Coupler x Adapter

#### Features

- Interchanges with all products produced to A-A-59326D
- Nitrile rubber seals standard
- Pressure rating for adapters is based on the seal of the mating part

Size	A380 Permanent Mold Aluminum Part #	316 Investment Cast Stainless Steel Part #
2" x 3"	G2030-DA-AL	---
3" x 2"	G3020-DA-AL	G3020-DA-SS
3" x 4"	G3040-DA-AL	---
4" x 3"	G4030-DA-AL	G4030-DA-SS
5" x 4"	G5040-DA-AL	---
6" X 4"	G6040-DA-AL	---



A380 permanent mold aluminum

B

## Global Type AA Spool Adapters

### Adapter x Adapter

#### Features

- Interchanges with all products produced to A-A-59326D
- Pressure rating for adapters is based on the seal of the mating part

Size	A380 Permanent Mold Aluminum Part #	316 Investment Cast Stainless Steel Part #
1"	G100-AA-AL	---
1-1/2"	G150-AA-AL	G150-AA-SS
1-1/2" x 2"	G1520-AA-AL	---
2"	G200-AA-AL	G200-AA-SS
2" x 3"	G2030-AA-AL	G2030-AA-SS
3"	G300-AA-AL	G300-AA-SS
3" x 4"	G3040-AA-AL	---
4"	G400-AA-AL	G400-AA-SS



A380 permanent mold aluminum



A380 permanent mold aluminum

## Global Type DD Couplers

### Coupler x Coupler

#### Features

- Interchanges with all products produced to A-A-59326D
- Nitrile rubber seals standard

Size	A380 Permanent Mold Aluminum Part #	316 Investment Cast Stainless Steel Part #
2"	G200-DD-AL	G200-DD-SS
3"	G300-DD-AL	G300-DD-SS
4"	G400-DD-AL	G400-DD-SS



A380 permanent mold aluminum

B

### Global Type A Jump Size Adapters

Adapter x Female NPT



**Features**

- Interchanges with all products produced to A-A-59326D
- Pressure rating for adapters is based on the seal of the mating part

Size	A380 Permanent Mold Aluminum Part #
3" x 2"	G3020-A-AL
4" x 3"	G4030-A-AL

### Global Type C Jump Size Couplers

Coupler x Hose shank



**Features**

- Interchanges with all products produced to A-A-59326D
- Nitrile rubber seals standard

Size	A380 Permanent Mold Aluminum Part #
3" x 2"	G3020-C-AL
4" x 3"	G4030-C-AL

### Global Type E Jump Size Adapters

Adapter x Hose Shank



**Features**

- Interchanges with all products produced to A-A-59326D
- Pressure rating for adapters is based on the seal of the mating part

Size	A380 Permanent Mold Aluminum Part #
3" x 2"	G3020-E-AL
4" x 3"	G4030-E-AL

NOTE: See page 8 for Global Crimp Type E adapters

### Global Adapter x TTMA Flange

**Features**

- Interchange with all products produced to A-A-59326D
- Nitrile rubber seals are standard
- Pressure rating for adapters is based on the seal of the mating part



Size	356T6 Aluminum Part #
4"	G400-ALT-AL

### Global Coupler x TTMA Flange



Size	356T6 Aluminum Part #
4"	G400-DLT-AL

NOTE: For flange dimensions, diagrams, and additional information, please reference [dixonvalve.com](http://dixonvalve.com).

### Global Adapter x ANSI Flange

Size	Aluminum Part #
4"	G400-AL-AL
6"	G600-AL-AL



**B**

### Global Coupler x ANSI Flange

Size	Aluminum Part #
4"	G400-DL-AL
6"	G600-DL-AL



### Handles for Aluminum / Brass Global Couplers

**Feature**

- Supplied complete with ring and pin

Fits on sizes	Investment Stainless Part #
1/2", 3/4"	G75HRP
1"	G100HRP
1-1/2", 2"	G152HRPSI
3" - 5"	G34HRPSI
6"	G600HRPSI



Fits on sizes	Forged Brass Part #
1-1/4" - 2-1/2"	G152HRP
3" - 5"	G34HRP
6", 8"	G600HRP



NOTE: Global Dixon® handle assemblies are to only be used with global Dixon parts (not domestic). Handles do not interchange with other manufacturers' handles or couplers. 

### Handles for Stainless Global Couplers

**Feature**

- Supplied complete with ring and pin

Fits on sizes	Investment Stainless Part #
1/2", 3/4"	G75HRPSS
1"	G100HRPSS
1-1/4" - 2-1/2"	G125250HRPSS
3" - 5"	G300400HRPSS
6"	G600HRPSS



NOTE: Global Dixon handle assemblies are to only be used with global Dixon parts (not domestic). Handles do not interchange with other manufacturers' handles or couplers. 

### Safety Clip for Global Couplers

Zinc Plated Carbon Steel Part #	Bag Qty
GSAFETYCLIP	25



**B**

**Global BSP Thread Cam & Groove**

**Features**

- Interchanges with products produced to A-A-59326D
- Pressure rating for adapters is based on the seal of the mating part
- Couplers: nitrile rubber seal is standard



**Type A - Adapter x Female BSPP**

Size	316 Investment Cast Stainless Steel Part #
1-1/2"	G150-A-SSBSP
2"	G200-A-SSBSP



**Type B - Coupler x Male BSPT**

Size	316 Investment Cast Stainless Steel Part #
1-1/2"	G150-B-SSBSP
2"	G200-B-SSBSP



**Type D - Coupler x Female BSPP**

Size	316 Investment Cast Stainless Steel Part #
1-1/2"	G150-D-SSBSP
2"	G200-D-SSBSP



**Type F - Adapter x Male BSPT**

Size	316 Investment Cast Stainless Steel Part #
1-1/2"	G150-F-SSBSP
2"	G200-F-SSBSP

## Cam & Groove x NST

### Features

- Powder coated aluminum adapter
- For suction and low pressure discharge only
- Other sizes, configurations, and materials available; contact Dixon® for information

**B**

### Type A x Female NST (NH)

Adapter Size	Female NST (NH) Thread	Aluminum Part #
1-1/2"	1-1/2"	G150-A-ALNST
2-1/2"	2-1/2"	G250-A-ALNST
3"	2-1/2"	3025-A-ALNST



### Type B x Male NST (NH)

#### Feature

- Nitrile rubber seals standard

Coupler Size	Male NST (NH) Thread	Aluminum Part #
1-1/2"	1-1/2"	G150-B-ALNST
2"	1-1/2"	2015-B-ALNST
2-1/2"	2-1/2"	G250-B-ALNST
3"	2-1/2"	3025-B-ALNST



### Type D x Female NST (NH)

#### Feature

- Nitrile rubber seals standard

Coupler Size	Female NST (NH) Thread	Aluminum Part #
1-1/2"	1-1/2"	G150-D-ALNST
2"	2-1/2"	2025-D-ALNST
2-1/2"	2-1/2"	G250-D-ALNST
3"	2-1/2"	3025-D-ALNST



### Type F x Male NST (NH)

Adapter Size	Male NST (NH) Thread	Aluminum Part #
1-1/2"	1-1/2"	G150-F-ALNST
2"	2-1/2"	2025-F-ALNST
2-1/2"	2-1/2"	G250-F-ALNST
3"	2-1/2"	3025-F-ALNST



## Type A Adapters

### Adapter x Female NPT

B

#### Features

- 1/2" couplers and adapters will interchange with 3/4" couplers and adapters, only the threads and barbs are 1/2"
- 1-1/4" couplers and adapters will interchange with 1-1/2" couplers and adapters, only the threads and barbs are 1-1/4"
- NOT recommended for use with PTFE gaskets, polypropylene cam & groove should not be mixed with metal fittings



#### Specification

- Maximum operating pressure: **125 PSI** (1/2" - 1"), **100 PSI** (1-1/4" - 2"), **60 PSI** (3"), and **50 PSI** (4"); recommendations based on the use of mating Dixon® fittings at an ambient temperature of **70°F (21°C)** with standard seal installed

Size	Glass-Filled Polypropylene Part #	Optional Qty
3/4" x 1/2"	PPA50	24
3/4"	PPA75	24
1"	PPA100	24
1-1/2" x 1-1/4"	PPA125	24
1-1/2"	PPA150	24
2"	PPA200	24
3"	PPA300	24
4"	PPA400	8

## Type B Couplers

### Coupler x Male NPT

#### Features

- Supplied with EPDM gaskets, 304 stainless steel handles and pins
- 1/2" couplers and adapters will interchange with 3/4" couplers and adapters, only the threads and barbs are 1/2"
- 1-1/4" couplers and adapters will interchange with 1-1/2" couplers and adapters, only the threads and barbs are 1-1/4"
- Replacements: gasket use EPR on page 69, key rings use R200SS on page 72, safety clip use GSAFETYCLIP on page 83
- NOT recommended for use with PTFE gaskets. Polypropylene cam & groove should not be mixed with metal fittings



#### Specification

- Maximum operating pressure: **125 PSI** (1/2" - 1"), **100 PSI** (1-1/4" - 2"), **60 PSI** (3"), and **50 PSI** (4"); recommendations based on the use of mating Dixon fittings at an ambient temperature of **70°F (21°C)** with standard seal installed

Size	Glass-Filled Polypropylene Part #	Optional Qty
3/4" x 1/2"	PPB50	24
3/4"	PPB75	24
1"	PPB100	24
1-1/2" x 1-1/4"	PPB125	24
1-1/2"	PPB150	24
2"	PPB200	24
3"	PPB300	24
4"	PPB400 <sup>1</sup>	8

<sup>1</sup> 4" coupler has 4 handles



## Type C Couplers

### Coupler x Hose Shank

**Features**

- Supplied with EPDM gaskets, 304 stainless steel handles and pins
- 1/2" couplers and adapters will interchange with 3/4" couplers and adapters, only the threads and barbs are 1/2"
- 1-1/4" couplers and adapters will interchange with 1-1/2" couplers and adapters, only the threads and barbs are 1-1/4"
- Replacements: gasket use EPR on page 69, pull rings use R200SS on page 72, safety clip use GSAFETYCLIP on page 83
- NOT recommended for use with PTFE gaskets, polypropylene cam & groove should not be mixed with metal fittings.

**Specification**

- Maximum operating pressure: **125 PSI** (1/2" - 1"), **100 PSI** (1-1/4" - 2"), **60 PSI** (3"), and **50 PSI** (4"); recommendations based on the use of mating Dixon® fittings at an ambient temperature of **70°F (21°C)** with standard seal installed



Size	Glass-Filled Polypropylene Part #	Optional Qty
3/4" x 1/2"	PPC50	24
3/4"	PPC75	24
1"	PPC100	24
1-1/2" x 1-1/4"	PPC125	24
1-1/2"	PPC150	24
2"	PPC200	24
3"	PPC300	24
4"	PPC400 <sup>1</sup>	8

<sup>1</sup> 4" coupler has 4 handles

## Type D Couplers

### Coupler x Female NPT

**Features**

- Supplied with EPDM gaskets, 304 stainless steel handles and pins
- 1/2" couplers and adapters will interchange with 3/4" couplers and adapters, only the threads and barbs are 1/2"
- 1-1/4" couplers and adapters will interchange with 1-1/2" couplers and adapters, only the threads and barbs are 1-1/4"
- Replacements: gasket use EPR on page 69, pull rings use R200SS on page 72, safety clip use GSAFETYCLIP on page 83
- NOT recommended for use with PTFE gaskets, polypropylene cam & groove should not be mixed with metal fittings.

**Specification**

- Maximum operating pressure: **125 PSI** (1/2" - 1"), **100 PSI** (1-1/4" - 2"), **60 PSI** (3"), and **50 PSI** (4"); recommendations based on the use of mating Dixon fittings at an ambient temperature of **70°F (21°C)** with standard seal installed



Size	Glass-Filled Polypropylene Part #	Optional Qty
3/4" x 1/2"	PPD50	24
3/4"	PPD75	24
1"	PPD100	24
1-1/2" x 1-1/4"	PPD125	24
1-1/2"	PPD150	24
2"	PPD200	24
3"	PPD300	24
4"	PPD400 <sup>1</sup>	8

<sup>1</sup> 4" coupler has 4 handles

## Type E Adapters

### Adapter x Hose Shank

B



#### Features

- 1/2" couplers and adapters will interchange with 3/4" couplers and adapters, only the threads and barbs are 1/2"
- 1-1/4" couplers and adapters will interchange with 1-1/2" couplers and adapters, only the threads and barbs are 1-1/4"
- NOT recommended for use with PTFE gaskets, polypropylene cam & groove should not be mixed with metal fittings



#### Specification

- Maximum operating pressure: **125 PSI** (1/2" - 1"), **100 PSI** (1-1/4" - 2"), **60 PSI** (3"), and **50 PSI** (4"); recommendations based on the use of mating Dixon® fittings at an ambient temperature of **70°F (21°C)** with standard seal installed

Size	Glass-Filled Polypropylene Part #	Optional Qty
3/4" x 1/2"	PPE50	24
3/4"	PPE75	24
1"	PPE100	24
1-1/2" x 1-1/4"	PPE125	24
1-1/2"	PPE150	24
2"	PPE200	24
3"	PPE300	24
4"	PPE400	8

## Type F Adapters

### Adapter x Male NPT

#### Features

- 1/2" couplers and adapters will interchange with 3/4" couplers and adapters, only the threads and barbs are 1/2"
- 1-1/4" couplers and adapters will interchange with 1-1/2" couplers and adapters, only the threads and barbs are 1-1/4"
- NOT recommended for use with PTFE gaskets, polypropylene cam & groove should not be mixed with metal fittings



#### Specification

- Maximum operating pressure: **125 PSI** (1/2" - 1"), **100 PSI** (1-1/4" - 2"), **60 PSI** (3"), and **50 PSI** (4"); recommendations based on the use of mating Dixon fittings at an ambient temperature of **70°F (21°C)** with standard seal installed

Size	Glass-Filled Polypropylene Part #	Optional Qty
3/4" x 1/2"	PPF50	24
3/4"	PPF75	24
1"	PPF100	24
1-1/2" x 1-1/4"	PPF125	24
1-1/2"	PPF150	24
2"	PPF200	24
3"	PPF300	24
4"	PPF400	8

## Dust Caps and Plugs

### Features

- Dust caps and dust plugs are not to be used in pressure applications for safety and environmental reasons
- NOT recommended for use with PTFE gaskets. Polypropylene cam & groove should not be mixed with metal fittings
- Supplied with EPDM gaskets, 304 stainless steel handles and pins
- Replacements: gasket use EPR on page 69, key rings use R200SS on page 72, safety clip use GSAFETYCLIP on page 83

### Type H Dust Caps

Size	Glass-Filled Polypropylene Part #	Optional Qty
3/4"	PPH75	24
1"	PPH100	24
1-1/2"	PPH150	24
2"	PPH200	24
3"	PPH300	24
4"	PPH400 <sup>1</sup>	8

<sup>1</sup> 4" coupler has 4 handles



### Type P Dust Plugs

Size	Glass-Filled Polypropylene Part #	Optional Qty
3/4"	PPP75	24
1"	PPP100	24
1-1/2"	PPP150	24
2"	PPP200	24
3"	PPP300	24
4"	PPP400	8



### Type A 90° Elbows Adapter x Female NPT

B



**Features**

- For use at elevated temperatures or other unusual operating conditions, consult Dixon
- NOT recommended for use with PTFE gaskets, polypropylene cam & groove should not be mixed with metal fittings



**Specification**

- Maximum operating pressure: **100 PSI** (1-1/2" - 2"); recommendations based on the use of mating Dixon® fittings at an ambient temperature of **70°F (21°C)** with standard seal installed

Size	Glass-Filled Polypropylene Part #	Optional Qty
1-1/2"	90PPA150	24
2"	90PPA200	24

### Type C 90° Elbows Coupler x Hose Shank



**Features**

- Supplied with EPDM gaskets, 304 stainless steel handles and pins
- For use at elevated temperatures or other unusual operating conditions, consult Dixon
- NOT recommended for use with PTFE gaskets, polypropylene cam & groove should not be mixed with metal fittings



**Specification**

- Maximum operating pressure: **100 PSI** (1-1/2" - 2"); recommendations based on the use of mating Dixon fittings at an ambient temperature of **70°F (21°C)** with standard seal installed

Size	Glass-Filled Polypropylene Part #	Optional Qty
1-1/2"	90PPC150	24
2"	90PPC200	24

### Type D 90° Elbows Coupler x Female NPT



**Features**

- Supplied with EPDM gaskets, 304 stainless steel handles and pins
- For use at elevated temperatures or other unusual operating conditions, consult Dixon
- NOT recommended for use with PTFE gaskets, polypropylene cam & groove should not be mixed with metal fittings



**Specification**

- Maximum operating pressure: **100 PSI** (1-1/2" - 2"); recommendations based on the use of mating Dixon fittings at an ambient temperature of **70°F (21°C)** with standard seal installed

Size	Glass-Filled Polypropylene Part #	Optional Qty
1-1/2"	90PPD150	24
2"	90PPD200	24

### Type F 90° Elbows Adapter x Male NPT



**Features**

- For use at elevated temperatures or other unusual operating conditions, consult Dixon
- NOT recommended for use with PTFE gaskets, polypropylene cam & groove should not be mixed with metal fittings



**Specification**

- Maximum operating pressure: **100 PSI** (1-1/2" - 2"); recommendations based on the use of mating Dixon fittings at an ambient temperature of **70°F (21°C)** with standard seal installed

Size	Glass-Filled Polypropylene Part #	Optional Qty
1-1/2"	90PPF150	24
2"	90PPF200	24

<b>Dry Disconnects .....</b>	<b>93 - 106</b>	<b>Dry Disconnects (Cont.) .....</b>	<b>93 - 106</b>
Bayloc® style .....	93 - 95	Marine series .....	105
Coupler x female NPT .....	93	Female NPT coupling .....	105
Greaseless coupler x female NPT .....	93	Male NPT coupling .....	105
Coupler x 90° swivel female NPT .....	93	150# flange .....	105
Coupler locking kits .....	93	Industrial series .....	106
Adapter x female NPT .....	94	Female NPT coupling .....	106
Jump size adapter x female NPT .....	94	Male NPT coupling .....	106
Adapter x 150# ASA flange .....	94	150# flange coupling .....	106
Vapor adapter x female NPSM .....	95	TTMA flanged .....	106
Cam and groove actuator style couplers .....	95		
Bayonet style .....	96 - 97	<b>Liquid Natural Gas Couplings .....</b>	<b>107</b>
90° swivel coupler x female NPT .....	96	Cap and plug .....	107
Straight coupler x female NPT .....	96		
Keyed straight coupler x female NPT .....	96	<b>Dry Evotek Couplings .....</b>	<b>108</b>
Straight swivel coupler x female NPT .....	96	Adapter x Female NPT .....	108
Keyed straight swivel coupler x female NPT .....	96	Adapter x 150# Flange .....	108
Straight swivel .....	96	Coupler x Female NPT .....	108
Adapter x female NPT .....	97	Coupler x 150# Flange .....	108
Keyed adapter x female NPT .....	97		
Dust plugs .....	97	<b>FloMAX Refueling .....</b>	<b>109 - 117</b>
Dust caps .....	97	Part number cross reference .....	109
Dixon® MannTek style .....	98 - 106	Diesel series .....	110 - 112
Coupler hose unit x female NPT .....	99	Nozzles .....	110
Coupler x 150# ASA flange .....	99	Receiver, one-piece body .....	110
Coupler x TTMA flange .....	99	Receiver, two-piece body .....	110
Dust plugs .....	99	Non-interchange nozzles and receivers .....	111
Adapter tank unit x female NPT .....	100	2" nozzles and receivers .....	111
Adapter tank unit x 150# flange .....	100	Gravity fill receivers .....	112
Adapter tank unit x TTMA flange .....	100	Fuel vents .....	112
Adapter weather protector with clamp .....	100	Fuel swivels .....	112
Dust caps .....	100	Service box .....	112
Steam coupler x female NPT .....	101	Standard series connectors .....	113 - 114
Steam adapter x female NPT .....	101	Engine oil nozzles and receivers .....	113
Dry gas couplings .....	102	Coolant fluid nozzles and receivers .....	113
Coupler hose unit x female NPT .....	102	Hydraulic oil nozzles and receivers .....	114
Dust plugs .....	102	Transmission nozzles and receivers .....	114
Adapter tank unit x female NPT .....	102	R series .....	115 - 116
Adapter tank unit x female ACME .....	102	Engine oil nozzles and receivers .....	115
Adapter tank unit x 150# ASA flange .....	102	Coolant fluid nozzles and receivers .....	115
Dust caps .....	102	Hydraulic oil nozzles and receivers .....	116
Dry aviation couplings .....	103 - 104	Transmission fluid nozzles and receivers .....	116
Coupler x female NPT .....	103	High flow series .....	117
Coupler x female BSP .....	103	3/4" nozzles and receivers .....	117
Dust plug .....	103	1" nozzles and receivers .....	117
Adapter x female NPT .....	104		
Adapter x 150# ASA flange .....	104		
Dust cap .....	104		
Safety Break-aways .....	105 - 106		

C

## TTMA Fittings .....118 - 123

Flange adapters .....	118
Slip-on flange .....	118
Buttweld flange .....	118
Spacer with 1/2" port .....	119
Flange extensions .....	119
Cam and groove .....	119
Adapter .....	119
Coupler .....	119
Dixon® vapor recovery couplers .....	120 - 121
With probe x adapter .....	120
With probe x coupler with probe .....	120
Coupler with probe x hose shank .....	120
Coupler x 45° hose shank .....	121
Coupler x female NPT .....	121
Bayloc vapor coupler with locking handle .....	121
EZ Boss-Lock Vapor Recovery Coupler with Probe .....	121
Flange gaskets .....	122
Flanged sight flow indicators .....	122 - 123
Sight flow indicator repair kits .....	123
Flange screen .....	123

## Railroad tank car connections .....124 - 127

Style A .....	124
Style F .....	124
Style GF .....	124
Screen .....	124
Style S .....	124
Style T .....	125
Dixon® coupler x tank car thread .....	125
EZ Boss-Lock x coupler tank car thread .....	125
Railroad unloading assemblies .....	126
Dixon tank car adapters .....	126
Cam and groove railroad tank car gaskets .....	127
Pin lug wrench .....	127

## Swivels .....128 - 138

Swivel joint overview .....	128 - 129
Single plane styles 20, 30 .....	130
Double plane styles 40, 50, 60 .....	130
Triple plane styles 10, 70, 80 .....	131
Ordering Information .....	132
Loading arm swivels .....	133
Loading arm swivels replacement parts .....	133
TTMA flange extensions .....	134
Loading arm .....	135 - 138
Overview .....	135
Split flange .....	136

## Swivels (Cont.) .....128 - 138

Split flange components .....	136
TTMA handle kit .....	137
Counterbalance clamps .....	137
Top loading valves .....	138
Top loading Diffusers / T-Deflectors .....	138

## API .....139 - 144

5500-Series couplers .....	139
Reelcraft® static discharge reel .....	140
Overfill protection rack monitors .....	141
FT590-Series terminal test equipment .....	141
Compatatible systems .....	142
Rack monitors .....	142
Rack cords .....	142
Junction boxes .....	142
Dixon MannTek break-away coupling .....	143
Rack cord assemblies .....	144
Rack cord parts .....	144

## ADS .....145 - 150

A100 Outalarm® with probe .....	145
A210 Spillguard® system .....	146 - 147
Monitors .....	146
Probes .....	147
Verification monitor .....	148
Ground clamp and junction box .....	148
Outage gauge .....	149
Gauge rods .....	149
Cables .....	149
Accessories .....	150

## Bayloc® Dry Disconnects Coupler x Female NPT

### Features

- Automatic closing poppet assembly
- Must be used with a DBA style adapter for coupler to operate, sold separately
- Fully interchangeable with Kamvalok (OPW trademark) fittings
- Aluminum fittings have stainless internals equivalent to 304 stainless
- Stainless handle allows exposure to corrosive chemicals or wash down service
- Heavy duty handle attachment prevents bending of crank assembly
- One-piece stainless crank and link provide long service life

- EZ Boss-Lock cam arms, standard on all 1-1/2" and 2" fittings, provide high security from accidental opening due to vibration or snagging
- Large paddle type locking cam arms, standard on 3" fittings, allow for an easy grip
- Optional coupler lock for handle to prevent unintentional opening

### Specifications

- Maximum operating pressure at 70°F (21°C):  
1-1/2" - 210 PSI  
2" - 150 PSI  
3" - 120 PSI

Female NPT	Coupler Size	Seal Material	Maximum PSI at 70°F (21°C)	Aluminum Part #	Stainless Steel <sup>1</sup> Part #
1-1/2"	2"	Nitrile rubber	210	DBC61-150	DBC71-150
2"	2-1/2"		150	DBC61-200	DBC71-200
3"	4"		120	DBC61-300	DBC71-300
1-1/2"	2"	FKM	210	DBC62-150	DBC72-150
2"	2-1/2"		150	DBC62-200	DBC72-200
3"	4"		120	DBC62-300	DBC72-300
1-1/2"	2"	PTFE Encapsulated Silicone & FFPM	210	DBC63-150	DBC73-150
2"	2-1/2"		150	DBC63-200	DBC73-200
3"	4"		120	DBC63-300	DBC73-300
1-1/2"	2"	EPDM	210	DBC64-150	DBC74-150
2"	2-1/2"		150	DBC64-200	DBC74-200
3"	4"		120	DBC64-300	DBC74-300
1-1/2"	2"	FFPM and PTFE <sup>2</sup>	210	---	DBC76-150
2"	2-1/2"		150	DBC66-200	DBC76-200
3"	4"		120	DBC66-300	DBC76-300
1-1/2"	2"	PTFE Encapsulated FKM & FFKM	210	---	DBC77-150
2"	2-1/2"		150	---	DBC77-200
3"	4"		120	---	DBC77-300
3"	4"	FKM-B	120	DBC69-300	DBC79-300



Coupler x 1-1/2" or 2" Female NPT



Coupler x 3" Female NPT

### Greaseless Coupler x Female NPT

Female NPT	Coupler Size	Seal Material	Stainless Steel <sup>1</sup> Part #
1-1/2"	2"	PTFE Encapsulated FKM & FFKM	DBC77-150-GL
2"	2-1/2"		DBC77-200-GL

<sup>1</sup> Stainless steel corrosion resistance is equivalent to 304 stainless steel

<sup>2</sup> FFPM gasket, main seal O-ring, and handle O-ring; PTFE seals on cylinder assembly, stuffing box, and seal under poppet screw



### Coupler x 90° Swivel Female NPT

Female NPT	Coupler Size	Seal Material	Aluminum Part #
2"	2-1/2"	Nitrile rubber	DBS61-200
		FKM	DBS62-200
		PTFE Encapsulated Silicone & FFPM	DBS63-200



### Coupler Locking Kits

Description	Aluminum Part #
for use with 1-1/2" and 2" dry disconnect couplers	DBCL-200
for use with 3" dry disconnect couplers	DBCL-300



NOTE: Reference page 80 for dust plugs for couplers.  
BSP Threads are available, contact Dixon for quote.

**Bayloc® Dry Disconnects**

**Adapter x Female NPT**

**Applications**

- Compatible with most cam and groove style dry disconnects
- Helps prevent spillage from normal or accidental disconnects
- For use in transfer of hazardous fluids

**Features**

- Two-piece adapter design for easy rebuilding of adapters
- Fully interchangeable with Kamvalok (OPW trademark) style fittings
- For pressure ratings at other temperatures, contact Dixon®
- Contact Dixon® at 800.355.1991 for chemical compatibility, size, material selection, and special configurations
- Spring loaded sealing device snaps closed should valve become disconnected with the poppet open

C



Adapter x 1-1/2" and 2" Female NPT



Adapter x 3" Female NPT

Female NPT	Adapter Size	Seal Material	Maximum PSI at 70°F (21°C)	Aluminum Part #	Stainless Steel Part #
1-1/2"	2"	Nitrile rubber	210	DBA11-150	DBA71-150
2"	2-1/2"		150	DBA11-200	DBA71-200
3"	4"		120	DBA11-300	DBA71-300
1-1/2"	2"	FKM	210	DBA12-150	DBA72-150
2"	2-1/2"		150	DBA12-200	DBA72-200
3"	4"		120	DBA12-300	DBA72-300
1-1/2"	2"	PTFE Encapsulated Silicone	210	DBA63-150	DBA73-150
2"	2-1/2"		150	DBA63-200	DBA73-200
3"	4"		120	DBA63-300	DBA73-300
1-1/2"	2"	EPDM	210	DBA64-150	DBA74-150
2"	2-1/2"		150	DBA64-200	DBA74-200
3"	4"		120	DBA64-300	DBA74-300
1-1/2"	2"	FFPM	210	DBA66-150	DBA76-150
2"	2-1/2"		150	DBA66-200	DBA76-200
3"	4"		120	DBA66-300	DBA76-300
1-1/2"	2"	PTFE Encapsulated FKM	210	---	DBA77-150
2"	2-1/2"		150	---	DBA77-200
3"	4"		120	---	DBA77-300
3"	4"	FKM-B	120	DBA69-300	---

**Jump Size Adapter x Female NPT**

Female NPT	Adapter Size	Seal Material	Maximum PSI at 70°F (21°C)	Aluminum Part #
2"	2"	Nitrile rubber	150	DBA11-1520
		FKM	150	DBA12-1520

**Adapter x 150# ASA Flange**

Flange Size	Adapter Size	Seal Material	Maximum PSI at 70°F (21°C)	Stainless Steel Part #
2"	2"	FKM	150	DBAF72-1520
		PTFE Encapsulated Silicone		DBAF73-1520
		EPDM		DBAF74-1520
		FFPM		DBAF76-1520
2"	2-1/2"	FKM	150	DBAF72-200
		PTFE Encapsulated Silicone		DBAF73-200
		EPDM		DBAF74-200
		FFPM		DBAF76-200
3"	4"	FKM	150	DBAF72-300
		PTFE Encapsulated Silicone		DBAF73-300
		EPDM		DBAF74-300
		FFPM		DBAF76-300

NOTE: Reference page 80 for dust caps for adapters.

For flange dimensions, diagrams, and additional information please reference [dixonvalve.com](http://dixonvalve.com). BSP Threads are available contact Dixon for quote.



## Bayloc® Dry Disconnect Vapor Adapter x Female NPSM

Female NPSM	Adapter Size	Seal	Max PSI at 70°F (21°C)	Stainless Steel <sup>1</sup> Part #
1-1/2"	2"	PTFE	150	DBAV73-2030



C

<sup>1</sup> Stainless steel corrosion resistance is equivalent to 304 stainless steel

NOTE: Reference page 80 for dust caps for adapters

### Cam & Groove Actuator Style Couplers

#### Applications

- Suited for vapor recovery, suction pump line and other applications where it is necessary to easily drain the hose or pipe for cleaning
- Can also be used when product retention in a hose or pipe is desired and damage from accidental spill from an open coupler is not a concern
- Couplers work with the DBA poppeted adapters on page 94 in applications where automatic closure for the coupler is not desired

#### Features

- EZ Boss-Lock cam arms
- Stainless steel locking lever standard
- Use with standard cam and groove dust plugs sized one size larger than the dry disconnect size
- Prevents spillage from normal and accidental disconnection of the connection

#### Materials

- Body: 316 stainless steel
- Internal components: 304 stainless steel
- Replacement parts are available; contact Dixon® for more information



Female NPT	Coupler Size	Seal Material	Stainless Steel Part #
1-1/2"	2"	Nitrile rubber	D2C71-150
2"	2-1/2"		D2C71-200
1-1/2"	2"	FKM	D2C72-150
2"	2-1/2"		D2C72-200
1-1/2"	2"	PTFE Encapsulated Silicone	D2C73-150
2"	2-1/2"		D2C73-200
1-1/2"	2"	EPDM	D2C74-150
2"	2-1/2"		D2C74-200
1-1/2"	2"	PTFE Encapsulated FKM	D2C77-150
2"	2-1/2"		D2C77-200
1-1/2"	2"	FKM-B	D2C79-150

### Bayonet Style Dry Disconnects

**Application**

- For the spill-less transfer of petroleum products such as fuel oil, lube oil blending and tank truck delivery

**Features**

- Ensures a spill-free connection. Fluid cannot flow until couplings are connected together and valve is opened; coupling can then not be disconnected until the valve handle is closed
- Swivels have standard ZERK fittings
- Replacement parts available; contact Dixon for more information

**Specification**

- Maximum operating pressure: **85 PSI at 70°F (21°C)**, for pressure ratings at other temperatures contact Dixon®

**90° Swivel Coupler x Female NPT**



Size	Seal Material	Anodized Hard Coat Aluminum Part #
2"	Nitrile rubber	BS61-200
	FKM	BS62-200
3"	Nitrile rubber	BS61-300
	FKM	BS62-300

**Straight Coupler x Female NPT**



Size	Seal Material	Anodized Hard Coat Aluminum Part #
2"	Nitrile rubber	BC61-200
	FKM	BC62-200

New

**Keyed Straight Coupler x Female NPT**



Size	Seal Material	Anodized Hard Coat Aluminum Part #
2"	Nitrile rubber	BC61K1-200
	FKM	BC62K1-200

**Straight Swivel Coupler x Female NPT**



Size	Seal Material	Anodized Hard Coat Aluminum Part #
1"	Nitrile rubber	BSS61-100
2"	Nitrile rubber	BSS61-200
	FKM	BSS62-200
3"	Nitrile rubber	BSS61-300
	FKM	BSS62-300

**Keyed Straight Swivel Coupler x Female NPT**

New



Size	Seal Material	Anodized Hard Coat Aluminum Part #
2"	Nitrile rubber	BSS61K1-200
	FKM	BSS62K1-200

**Straight Swivel**

Size	Seal Material	PSI @ 75°F (24°C)	Anodized Hard Coat Aluminum Part #
1"	Nitrile rubber	85	BSSW61-100

## Bayonet Style Dry Disconnects

### Application

- For the spill-less transfer of petroleum products such as fuel oil, lube oil blending, and tank truck delivery

### Features

- Ensures a spill-free connection. Fluid cannot flow until couplings are connected together and valve is opened; coupling can then not be disconnected until the valve handle is closed.
- Swivels have standard ZERK fittings
- Replacement parts available; contact Dixon for more information

### Specification

- Maximum operating pressure: **85 PSI at 70°F (21°C)**. For pressure ratings at other temperatures contact Dixon®

#### Adapter x Female NPT

Size	Seal Material	Stainless Steel Part #	Brass Part #	Aluminum Part #
1"	Nitrile rubber	---	BA61-100	---
2"	Nitrile rubber	BA31-200	---	---
	FKM	BA32-200	---	---
3"	Nitrile rubber	---	BA31-300	BA61-300
	FKM	---	BA32-300	BA62-300



#### Keyed Adapter x Female NPT

Size	Seal Material	Stainless Steel Part #
2"	Nitrile rubber	BA31K1-200
	FKM	BA32K1-200



#### Dust Plugs

Size	Rubber with Stainless Steel Chain Part #
2"	BCP-200
3"	BCP-300



#### Dust Caps

Size	Rubber with Stainless Steel Chain Part #
2"	BAC-200
3"	BAC-300



C

## Dixon® MannTek Dry Disconnect Couplings

### Applications

- Used by producers of ink, adhesives, fatty acids, pharmaceuticals, liquid soaps, petroleum, chemicals, agricultural products, and a wide variety of common caustic and specialty acids
- Designed for the quick and spill-free connection and disconnection of hoses and pipelines

### Features

- Easy to handle: push and turn - free flow; turn and pull - closed
- Time saving: no need to drain hoses or pipe systems
- Economical: no loss or spillage of liquids at connection or disconnection
- Safety: the valve cannot be opened until the unit is coupled
- Environmentally friendly: accidental spillage eliminated when properly used
- Safe and reliable: due to rugged construction
- Product life: uncomplicated design and high-quality materials ensure long product life
- Selectivity: To avoid product contamination, selective versions of the couplers and adapters are available. Contact Dixon for further information.
- Produced according to NATO standard STANAG 3756 and ATOFINA SGM 2049.TUY.C.
- Seal kits are available
- Interchanges with Avery Hardoll® and Todo-MATIC®



### Materials

- Standard seal supplied: FKM
- Optional seals:
  - EPDM
  - NBR - nitrile
  - Kalrez®
  - Chemraz®

### Specifications

- Working pressure at ambient temperature 70°F (21°C):
  - aluminum: **230 PSI**, up to 4"
  - brass/gunmetal<sup>1</sup>: **230 PSI**, up to 4"
  - stainless steel: **360 PSI**

<sup>1</sup> Produced to U.S. government bronze specification G

## How it Works

The principle of operation is identical for all sizes of couplings.

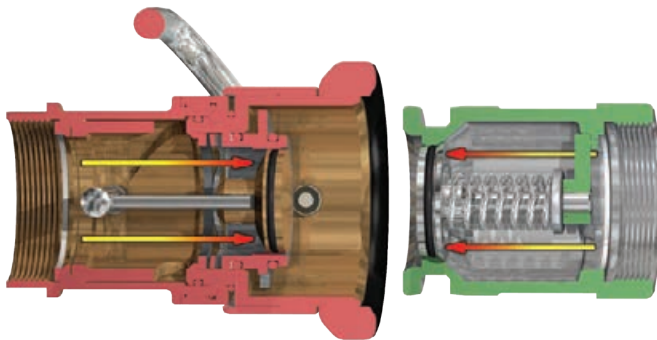

### Closed

- Turn and pull  
It's released - no spillage

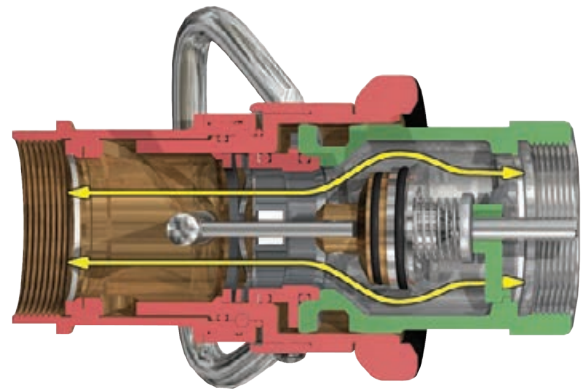

### Open

- Push and turn  
It's coupled - full flow

## Dixon® MannTek Dry Disconnect Couplers - Hose Unit

### Features

- Coupler has built-in swivel
- Stainless steel shaft journal embedded in PTFE to eliminate seizure
- Riveted piston pin to minimize the risk for failure under extreme pressure conditions
- The protective ring is a specially formulated, weather resistant, and electrically conductive rubber compound
- Composite (Polyeten PE-HD 300) plugs provide good protection against corrosion and withstand hot and cold environments

### Materials

- Stainless steel ball bearings
- Stainless steel couplers: rollers are Hastelloy C276 on the stainless steel shaft
- All wetted parts are stainless steel
- Aluminum and brass couplers: rollers are aluminum-bronze on the stainless steel shaft

C

### Coupler x Female NPT



Female NPT	Body Size	316 Stainless Steel Part #	Aluminum Part #	Brass / Gunmetal <sup>1</sup> Part #
3/4"	56 mm	DDC075SS	DDC075AL	DDC075BR
1"	56 mm	DDC100SS	DDC100AL	DDC100BR
1-1/2"	70 mm	DDC150SS	DDC150AL	DDC150BR
2"	70 mm	DDC200SS	DDC200AL	DDC200BR
3"	105 mm	DDC300SS105	DDC300AL105	DDC300GM105
3"	119 mm	DDC300SS	DDC300AL	DDC300GM
4"	164 mm	DDC400SS	DDC400AL	DDC400GM
6"	238 mm	DDC600SS	DDC600AL	---

<sup>1</sup> Produced to U.S. government bronze specification G

### Coupler x 150# ASA Flange

150# Flange	Body Size	316 Stainless Steel Part #
2"	70 mm	DDC200SSFL
3"	119 mm	DDC300SSFL
4"	164 mm	DDC400SSFL
6"	238 mm	DDC600SSFL
8"	272 mm	DDC800SSFL



NOTE: For flange dimensions, diagrams, and additional information, please reference [dixonvalve.com](http://dixonvalve.com).

### Coupler x TTMA Flange

TTMA Flange	Body Size	Aluminum Part #
4"	164 mm	DDC400AL164TTMA

NOTE: For flange dimensions, diagrams, and additional information, please reference [dixonvalve.com](http://dixonvalve.com).

### Dust Plugs

Body Size	Polyeten PE-HD 300 Part #
56 mm	DDDP075
70 mm	DDDP150
105 mm	DDDP300105
119 mm	DDDP300
164 mm	DDDP400
238 mm	DDDP600 <sup>1</sup>

<sup>1</sup> Aluminum

NOTE: Refer to body size when selecting a plug.



## Dixon® MannTek Dry Disconnect Adapters - Tank Unit

### Application

- Usually installed on the tank or manifold

### Features

- Conical valve seat reduces the risk for piston blowout
- PTFE bearing between piston shaft and guide eliminates risk of seizure
- Composite (Polyeten PE-HD 300) cap to provide good protection in harsh environments
- FKM (FPM) gaskets standard on polyeten caps

### Materials

- Aluminum adapter: aluminum poppet, stainless steel internal parts
- Stainless steel adapter: stainless steel poppet, stainless steel internal parts
- Brass / gunmetal<sup>1</sup> adapter: brass poppet, brass and stainless steel internal parts

#### Adapter x Female NPT



Female NPT	Body Size	316 Stainless Steel Part #	Aluminum Part #	Brass / Gunmetal <sup>1</sup> Part #
3/4"	56 mm	DDA075SS	DDA075AL	DDA075BR
1"	56 mm	DDA100SS	DDA100AL	DDA100BR
1-1/2"	70 mm	DDA150SS	DDA150AL	DDA150BR
2"	70 mm	DDA200SS	DDA200AL	DDA200BR
3"	105 mm	DDA300SS105	DDA300AL105	DDA300GM105
3"	119 mm	DDA300SS	DDA300AL	DDA300GM
4"	164 mm	DDA400SS	DDA400AL	DDA400GM
6"	238 mm	DDA600SS	DDA600AL	---

#### Adapter x 150# ASA Flange



150# Flange	Body Size	316 Stainless Steel Part #	Aluminum Part #	Brass / Gunmetal <sup>1</sup> Part #
3/4"	56 mm	DDA075SSFL	---	---
1"	56 mm	DDA100SSFL	DDA100ALFL	DDA100BRFL
1-1/2"	70 mm	DDA150SSFL	DDA150ALFL	DDA150BRFL
2"	70 mm	DDA200SSFL	DDA200ALFL	DDA200BRFL
3"	105 mm	DDA300SS105FL	DDA300AL105FL	DDA300GM105FL
3"	119 mm	DDA300SSFL	DDA300ALFL	DDA300GMFL
4"	164 mm	DDA400SSFL	DDA400ALFL	DDA400GMFL
6"	238 mm	DDA600SSFL	DDA600ALFL	---
8"	272 mm	DDA800SSFL	---	---

<sup>1</sup> Produced to U.S. government bronze specification G

NOTE: For flange dimensions, diagrams, and additional information, please reference dixonvalve.com.

#### Adapter x TTMA Flange



TTMA Flange	Body Size	Aluminum Part #
3"	105 mm	DDA300AL105TTMA
3"	119 mm	DDA300AL119TTMA
4"	164 mm	DDA400AL164TTMA

NOTE: For flange dimensions, diagrams, and additional information, please reference dixonvalve.com.

#### Adapter Weather Protector with Clamp



Size	Black Neoprene Part #
2"	PCDVCHSS36

#### Dust Caps



Body Size	Polyeten PE-HD 300 Part #
56 mm	DDDC075
70 mm	DDDC150
105 mm	DDDC300105
119 mm	DDDC300
164 mm	DDDC400
238 mm	DDDC600 <sup>1</sup>

<sup>1</sup> 6" dust cap is aluminum

NOTE: Reference page 102 for rubber dust caps. Refer to body size when selecting a cap.

## Dixon® MannTek Dry Disconnects for Steam Service

### Applications

- Designed to fit hoses carrying steam used in chemical (heating), pharmaceutical (disinfection and sterilization), and at loading bays

### Features

- Unintentional separation is eliminated preventing accidents and avoiding unintended downtime
- Performance unaffected by surface rust
- Lockable versions are available on 1-1/2" and 2"; contact Dixon
- Couplers supplied with double handles

### Materials

- Coupling housing and all inner parts: stainless steel
- EPDM 291 seal

### Specification

- 150 PSI at 350°F (177°C)

#### Coupler x Female NPT

Female NPT	Body Size	316 Stainless Steel Part #
3/4"	56 mm	DDSC075SS
1"		DDSC100SS
1-1/2"	70 mm	DDSC150SS
2"		DDSC200SS



#### Adapter x Female NPT

Female NPT	Body Size	316 Stainless Steel Part #
3/4"	56 mm	DDSA075SS
1"		DDSA100SS
1-1/2"	70 mm	DDSA150SS
2"		DDSA200SS



C

**Dixon® MannTek Dry Gas Couplings**

**Applications**

- Primary application is in the handling of LPG - Propane and Butane
- Designed for loading and discharge of bobtails or intermediate bulk delivery trucks to and from rail cars

**Features**

- Reliable, easy to maintain
- Minimizes the risk of cold burns, spillage, product loss, and health risks and keeps the environment free of hazardous vapors and liquids
- Compatible with existing dry disconnect couplings
- Composite (Polyeten PE-HD 300) plug provides good protection in harsh environments
- For pressure relief options, contact Dixon

**Materials**

- Stainless steel and brass / gunmetal (produced to U.S. government bronze specification G)
- Low temperature FKM (FPM) seals

**Specifications**

- Working pressure: **360 PSI** at ambient temperature **70°F (21°C)**
- Can be coupled to a tank unit with pressures up to **225 PSI** at ambient temperature **70°F (21°C)**, if pressure is higher, equip couplings with pressure relief valves

**Coupler x Female NPT**

Female NPT	Body Size	316 Stainless Steel Part #
1"	56 mm	DGC100SS
2"	71 mm	DGC200SS
3"	119 mm	DGC300SS

**Dust Plug for Couplers**

Size	Body Size	Polyeten PE-HD 300 Part #
1"	56 mm	DGDP100
2"	71 mm	DGDP200
3"	119 mm	DGDP300

**Adapter x Female NPT**

Female NPT	Body Size	316 Stainless Steel Part #
1"	56 mm	DGA100SS
2"	71 mm	DGA200SS
3"	119 mm	DGA300SS

**Adapter x Female ACME**

Female ACME	Body Size	316 Stainless Steel Part #
1-3/4"	56 mm	DGA100SS175
3-1/4"	71 mm	DGA200SS325

**Adapter-Tank Unit x 150# ASA Flange**

150# Flange	Body Size	316 Stainless Steel Part #
1"	56 mm	DGA100SSFL
2"	71 mm	DGA200SSFL
3"	119 mm	DGA300SSFL

NOTE: For flange dimensions, diagrams, and additional information, please reference [dixonvalve.com](http://dixonvalve.com).

**Dust Cap for Adapters**

Body Size	Material	Part #
56 mm	polyeten PE-HD300	DGDC100
71 mm	rubber	DGDC200
119 mm	rubber	DGDC300

NOTE: Refer to body size when selecting a cap.

C





## Dixon® MannTek Dry Aviation Couplers - Hose Unit

### Application

- Designed for use in aviation refueling systems

### Features

- Composite (Polyeten PE-HD 300) plug provides good protection in harsh environments
- Accepts international standard 2-1/2" point bayonet, hose end refueling nozzles according to: ISO45 / MS24484 / STANAG 3105 / British Aerospace Spec. 2C14, they are not configured for under-wing refueling
- Gunmetal coupling ring minimizes the risk of seizure
- Riveted piston pin minimizes risk of failure under extreme pressure conditions
- Protective ring is a specially formulated weather resistant and electrically conductive rubber compound



C

### Materials

- Body: high-strength aluminum
- Coupling ring: gunmetal (produced to U.S. government bronze specification G)
- Bayonet flange and inner parts: stainless steel, aluminum
- All wetted parts are aluminum and stainless steel
- Stainless steel ball bearings
- Stainless steel shaft journal embedded in PTFE eliminates seizure
- PTFE bearings between the driving plate and piston guide eliminate the risk of seizure

### Specification

- Working pressure: **150 PSI** at ambient temperature **70°F (21°C)**

#### Coupler x Female NPT

Female NPT	Body Size	Aluminum Part #
2-1/2"	ISO 45	DAC250AL
3"	ISO 45	DAC300AL

#### Coupler x Female BSP

Female BSP	Body Size	Aluminum Part #
2-1/2"	ISO 45	DAC250ALBSP
3"	ISO 45	DAC300ALBSP



#### Dust Plug for Couplers

Body Size	Polyeten PE-HD300 Part #
ISO 45	DADP250



NOTE: Refer to body size when selecting a plug.

C

## Dixon® MannTek Dry Aviation Adapters - Tank Unit

### Application

- Designed for use in aviation refueling systems

### Features

- Composite (Polyeten PE-HD 300) cap provides good protection in harsh environments
- Accepts international standard 2-1/2" point bayonet hose end refueling nozzles according to: ISO45 / MS24484 / STANAG 3105 / British Aerospace Spec. 2C14. Not configured for under-wing refueling
- Gunmetal coupling ring minimizes the risk of seizure
- PTFE bearings between the piston shaft and the piston guide eliminate the risk of seizure
- Conical valve seat eliminates the risk of piston blowout when extreme pressure is used



### Materials

- Body: high-strength aluminum
- Coupling ring: gunmetal
- Bayonet flange and inner parts: stainless steel, aluminum
- All wetted parts: aluminum and stainless steel

### Specification

- Working pressure: 150 PSI at ambient temperature 70°F (21°C)



Adapter x Female NPT

Size	Body Size	Aluminum Part #
2-1/2"	ISO 45	DAA250AL
3"	ISO 45	DAA300AL



Adapter x 150# ASA Flange

150# Flange	Body Size	Aluminum Part #
2-1/2"	ISO 45	DAA250ALFL
3"	ISO 45	DAA300ALFL

NOTE: For flange dimensions, diagrams, and additional information, please reference [dixonvalve.com](http://dixonvalve.com).



Dust Cap for Adapters

Body Size	Polyeten PE-HD 300 Part #
ISO 45	DADC250

NOTE: Refer to body size when selecting a cap.

## Dixon® MannTek Safety Break-away Couplings - Marine Version

### Application

- Typically for ship-to-offshore platform and ship-to-ship product transfer operations

### Features

- Designed to be installed within a hose string where the coupling will have a length of hose attached to both sides
- Minimizes spillage and damage associated with pull-away incidents
- Coupling automatically senses excessive load, closes the valves and disconnects. Release is executed when force causes bolts to break
- FKM (FPM) O-rings, additional seal materials are available
- Optional non-closure design available; contact Dixon

### Specification

- Working pressure: **360 PSI** at ambient temperature **70°F (21°C)**



#### Female NPT x Female NPT

Size	DN Size	316 Stainless Steel Part #
2"	50	MSBC200SS
3"	80	MSBC300SS
4"	100	MSBC400SS
5"	125	MSBC500SS
6"	150	MSBC600SS



#### Male NPT x Male NPT

Size	DN Size	316 Stainless Steel Part #
2"	50	MSBC200SSMNPT
3"	80	MSBC300SSMNPT
4"	100	MSBC400SSMNPT
5"	125	MSBC500SSMNPT
6"	150	MSBC600SSMNPT



#### 150# Flange x 150 Flange

Size	DN Size	316 Stainless Steel Part #
2"	50	MSBC200SSFL
3"	80	MSBC300SSFL
4"	100	MSBC400SSFL
5"	125	MSBC500SSFL
6"	150	MSBC600SSFL
8"	200	MSBC800SSFL



NOTE: For flange dimensions, diagrams, and additional information, please reference [dixonvalve.com](http://dixonvalve.com).

### How it Works

Safety break-away couplings have three external break bolts. In the case of axial tension, all of the bolts take up the force corresponding to the break force on the hose with a safety margin. Non-axial forces concentrate the tension forces more strongly on one bolt, so that the safety break-away coupling reacts in a natural way to the reduction of the hose break forces.

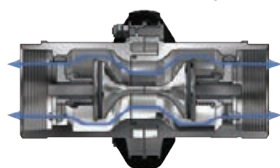

**BEFORE** emergency disconnect

The safety break-away valve consists of two halves, each with a valve that has a O-ring seal.

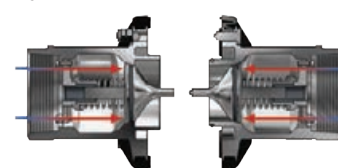

**AFTER** emergency disconnect

When the safety break-away couplings separate, it allows the valves to close. The two valves close rapidly, minimizing exposure to personnel and the environment.

**Dixon® MannTek Safety Break-away Couplings - Industrial Version**

**Application**

- Loading rack, bulk loading / unloading, road tankers, and rail tankers



**Features**

- Designed to be installed between a fixed point (pipe, pump, manifold) and a hose
- Minimizes spillage and damage associated with pull-away incidents
- Coupling automatically senses excessive load, closes valves and disconnects. Release is executed when force causes bolts to break.
- High flow rate / low pressure drop
- FKM (FPM) seal standard, additional seal materials are available
- Optional non-closure design available; contact Dixon®

**Specification**

- Working pressure: stainless steel **360 PSI** and aluminum **230 PSI** at ambient temperature **70°F (21°C)**

**Female NPT x Female NPT**



Size	DN Size	316 Stainless Steel Part #	Aluminum Part #
1"	25	SBC100SS	SBC100AL
2"	50	SBC200SS	SBC200AL
3"	80	SBC300SS	SBC300AL
4"	100	SBC400SS	SBC400AL
5"	125	SBC500SS	SBC500AL
6"	150	SBC600SS	SBC600AL

**Male NPT x Male NPT**



Size	DN Size	316 Stainless Steel Part #	Aluminum Part #
2"	50	SBC200SSMNPT	SBC200ALMNPT
3"	80	SBC300SSMNPT	SBC300ALMNPT
4"	100	SBC400SSMNPT	SBC400ALMNPT
5"	125	SBC500SSMNPT	SBC500ALMNPT
6"	150	SBC600SSMNPT	SBC600ALMNPT

**150# Flange x 150# Flange**



Size	DN Size	316 Stainless Steel Part #	Aluminum Part #
1"	25	SBC100SSFL	---
2"	50	SBC200SSFL	SBC200ALFL
3"	80	SBC300SSFL	SBC300ALFL
4"	100	SBC400SSFL	SBC400ALFL
5"	125	SBC500SSFL	SBC500ALFL
6"	150	SBC600SSFL	SBC600ALFL
8"	200	SBC800SSFL	---

NOTE: For flange dimensions, diagrams, and additional information, please reference [dixonvalve.com](http://dixonvalve.com).

**TTMA Flanged Breakaway Coupling**

**Features**

- Minimizes spillage and damage associated with drive-away and pull-away incidents
- Installs between an API coupler and loading arm
- Coupling automatically senses excessive load, closes the valves and disconnects. Release is executed when force causes the bolts to break
- High flow rate / low pressure drop
- FKM/FPM is standard seal

**Specification**

- **150 PSI** at ambient temperature **70°F (21°C)**



SBC400ALTMA



SBC400ALTMASV

Size	Aluminum Part #
4"	SBC400ALTMA
	SBC400ALTMASV

NOTE: For flange dimensions, diagrams, and additional information, please reference [dixonvalve.com](http://dixonvalve.com).

## Liquid Natural Gas Couplings

### Application

- Safe and reliable transfer of cryogenic liquefied natural gas (LNG) products to transport equipment such as cargo tanks, portable tanks, and liquefied natural gas liquid production facilities

### Sizes

- 2", 3"

### Features

- Fixed end design threads on tank truck pipe connection line, manifold, pipe outlet, or pipe connection
- PTFE gasket reduces force needed to make a tight connection
- Connect by hammering the acme threaded nut onto a fixed end
- Hose end designed female NPT thread attached to hose end
- Snap ring keeps connection nut in place for easier connecting
- Hose end lugs intended to be struck with a non-sparking hammer or similar non-sparking device

### Materials

- Body: brass
- Seal: PTFE

### Specifications

- Compatible with LNG couplings made to CGA guidelines
- Temperature as low as **-320°F (-196°C)** at standard LNG transfer pressures
- **450 PSI** working pressure with 4 to 1 safety factor

### Approval

- Meets CGA V-6 LNG-30 guidelines

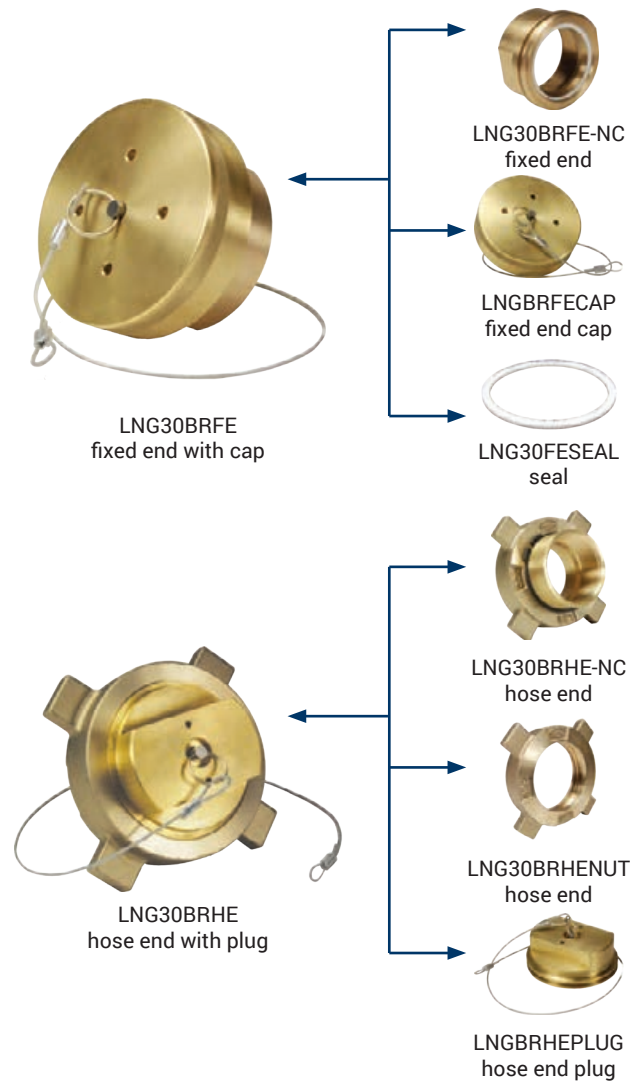

C

Size	Description	Part #
2"	LNG30 fixed end with 2" female NPT thread / cap and retaining cable	LNG20BRFE
3"	LNG30 fixed end with 3" female NPT thread / cap and retaining cable	LNG30BRFE
3"	LNG30 fixed end with 3" female NPT thread	LNG30BRFE-NC
3"	LNG30 PTFE seal	LNG30FESEAL
--	Cap for LNG30BRFE and LNG20BRFE	LNGBRFECAP

Size	Description	Part #
2"	LNG30 hose end with 2" female NPT thread / with plug and retaining	LNG20BRHE
3"	LNG30 hose end with 3" female NPT thread / with plug and retaining	LNG30BRHE
2"	LNG20 hose end with 2" female NPT thread	LNG20BRHE-NC
3"	LNG30 hose end with 3" female NPT thread	LNG30BRHE-NC
3"	LNG30 swivel nut	LNG30BRHENUT
--	Plug for LNG30BRHE and LNG20BRHE	LNGBRHEPLUG

Dry Evotek Couplings

Applications

- Specifically designed for use in the chemical industry
- Rotating the coupling 120° clockwise opens the valves where the pressure engagement between hose and tank unit ensures a strong connection

Sizes

- 1", 1-1/2", and 2"
- Additional sizes upon request

Features

- Low connecting forces even against pressure
- Ergonomic handle on 1-1/2" and 2" sizes
- Good transmission ratio in the cam curve
- Wide range of chemical resistance due to high-quality material selection
- Minimized spillage during de-coupling

Materials

- Body: stainless steel 1.4404
- Handle: PP polypropylene; 1" does not come with a handle
- O-rings: FPM, NBR, EPDM, FFKM
- Standard seal: FKM
- Optional seal: EPDM, NBR, and FFKM

Specification

- Working pressure: **360 PSI** at ambient temperature 70°F (21°C)

Approvals

- PED 2014/68/EU 4.3
- ATEX 2014/34/EU Category 3G



Adapter x Female NPT



Female NPT	Body Size	Part #
1"	59.5 mm	DDEA100SS
1-1/2"	89 mm	DDEA150SS
2"	106 mm	DDEA200SS

Adapter x 150# Flange



150# Flange	Body Size	Part #
1"	59.5 mm	DDEA100SSFL
1-1/2"	89 mm	DDEA150SSFL
2"	106 mm	DDEA200SSFL

Coupler x Female NPT

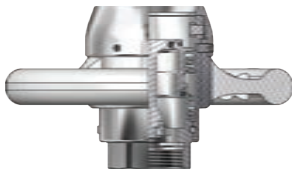

Female NPT	Body Size	Part #
1"	59.5 mm	DDEC100SS
1-1/2"	89 mm	DDEC150SS
2"	106 mm	DDEC200SS

Coupler x 150# Flange

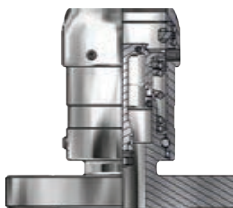

150# Flange	Body Size	Part #
1"	59.5 mm	DDEC100SSFL
1-1/2"	89 mm	DDEC150SSFL
2"	106 mm	DDEC200SSFL

### FloMAX Part Number Cross Reference

#### Standard Series Connectors

Dixon® Part #	Caterpillar® Part #	Wiggins Part #	FastFill
Engine Oil Nozzles	---	---	---
ENBL	9S9273	OS2	N100
ENBL-P	---	OSP2	N100P
ENBL-PLUG	9S9274	OP-12	P100
ERJ	---	ON6	---
Engine Oil Receivers	---	---	---
ERS	9S9271	ON2	R100
ERS-C	---	ONC2A	R100C
ERS-CAP	9S9272	O3B12P	C100
Coolant Fluid Nozzles	---	---	---
CN	108-5455	EC280B8	N200
CN-P	---	---	N200P
CN-PLUG	108-5456	1209-8	P200
Coolant Fluid Receivers	---	---	---
CR-S	IQ5459	EC285A8	---
CR-C	---	---	R200C
CR-CAP	5P3587	1208-8	C200
Hydraulic Oil Nozzles	---	---	---
HN	108-5433	6000B12	N300
HN-P	---	---	N300P
HN-PLUG	---	6009-12	P300
Hydraulic Oil Receivers	---	---	---
HR	108-5454	6005A12	R300
HR-C	---	---	R300C
HR-CAP	IQ-5468	6008-12	C300
Transmission Fluid Nozzles	---	---	---
TN	126-7538	C-1807	N400
TN-P	---	---	N400P
TN-PLUG	---	P-1844	P400
Transmission Fluid Receivers	---	---	---
TR	108-5456	P-1804	R400
TR-C	---	---	R400C
TR-CAP	SP3587	P-1880	C400

#### Fuel Vent Series

Dixon Part #	Caterpillar® Part #	Wiggins Part #	FastFill
VT	6G7803	ZV10	V150
VT7	---	ZV10F	V150L7
VT9	---	ZV10	---
VTT	5V6106	ZV10C	V150C
VT-C	---	ZV10A	V150A
VT-A-7	9G01965	ZV11	V150D
VT-A-9	4T1314	ZV11A	---

#### R Series Connectors

Dixon Part #	Caterpillar® Part #	Wiggins Part #	FastFill
Engine Oil Nozzles	---	---	---
R-EN	---	R15	N100R
R-EN-P	---	---	N100RP
R-EN-PLUG	---	R1507	P100R
Engine Oil Receivers	---	---	---
R-ER	---	R16	R100R
R-ER-C	---	---	R100RC
R-ER-CAP	---	R1605	C100R
Coolant Fluid Nozzles	---	---	---
R-CN	---	R11	N200R
R-CN-P	---	---	N200RP
R-CN-PLUG	---	R1107	P200R
Coolant Fluid Receivers	---	---	---
R-CR	---	R12	R200R
R-CR-C	---	---	R200RC
R-CR-CAP	---	R1205	C200R
Hydraulic Oil Nozzles	---	---	---
R-HN	---	R17	N300R
R-HN-P	---	---	N300RP
R-HN-PLUG	---	R1707	P300R
Hydraulic Oil Receivers	---	---	---
R-HR	---	R18	R300R
R-HR-C	---	---	R300RC
R-HR-CAP	---	R1805	C300R
Transmission Fluid Nozzles	---	---	---
R-TN	---	R13	N400R
R-TN-P	---	---	N400RP
R-TN-PLUG	---	R1307	P400R
Transmission Fluid Receivers	---	---	---
R-TR	---	R14	R400R
R-TR-C	---	---	R400CR
R-TR-CAP	---	R1405	C400R

#### Diesel Fueling System

Dixon Part #	Caterpillar® Part #	Wiggins Part #	FastFill	Shaw
Nozzles	---	---	---	---
FN600	---	ZZF150	N150CP	---
FN600BL	---	ZZ9A1	N150SL	---
FN600B-PLUG	---	---	---	---
Receivers	---	---	---	---
FRS	2G9000	ZN2A	R150S	---
FRS-C	---	ZNC2A	R150SC	---
FRA	---	ZN2A	R150AL	---
FRA-C	---	ZNC2A	R150ALC	---
FR-CAP	0D0630	ZC20P	C150	388-4327
FR2	9D0630	---	---	---
FR2-C	---	---	---	---
FR2-R	---	---	---	---
GFR-0	---	ZN6A	A150A	---
GFR-45	---	---	---	---
GFR-90	---	ZN6B	A150B	---
GFR1-0	---	ZN6B	---	---
GFR1-45	---	---	---	---
GFR1-90	---	ZN6B	---	---
FNS	---	ZS9	S150	---
FNS2	---	---	---	---
FN600S	---	---	---	---
BFN	---	ZS5	28-N150B	---
BH-F	---	---	FFF5C	---
FNS10	---	---	---	---
FR-SOCKET	---	---	R150SW	---
BH-W	---	---	FFF4C	---

## FloMAX Diesel Fueling System

### Application

- Designed for on-site refueling of construction, mining, forestry, and agricultural equipment

C

### Diesel Fuel Nozzles

#### Features

- 1-1/2" female NPT
- Tested to **180 gallons per minute**
- Integrated high-flow swivel and sealing plug
- Plug/bumper assembly gives complete nose seal
- Investment cast aluminum housing
- Anodized aluminum non-wear parts
- Stainless steel wear components
- Delron® bushings eliminate metal-to-metal wear
- Interchanges with Caterpillar® and Wiggins systems



Description	Part #
dog latch mechanism with sealing plug	FN600
ball lock with sealing plug	FN600BL
sealing plug for FN600	FN600B-PLUG
sealing plug for FN600BL	FN600B

### One-Piece Diesel Fuel Receivers

#### Features

- 2" male NPT
- O-ring sealed aluminum cap
- Cap has set screw attached vinyl coated cable lanyard



Description	Material	Part #
one-piece receiver without cap	nickel-plated steel	FRS
one-piece receiver with cap	nickel-plated steel	FRS-C
one-piece receiver without cap	anodized aluminum	FRA
one-piece receiver with cap	anodized aluminum	FRA-C
cap for receiver	anodized aluminum	FR-CAP

### Two-Piece Diesel Fuel Receivers

#### Features

- 2" male NPT
- O-ring sealed aluminum cap
- Cap has set screw attached vinyl coated cable lanyard



Description	Part #
two-piece receiver with removable stainless sleeve, without cap	FR-RS
two-piece receiver with removable stainless sleeve with cap	FR-RS-C
removable sleeve replacement for two-piece receiver	FR-RS-R
cap for receiver	FR-CAP



## FloMAX Diesel Fueling System

### Non-Interchange Diesel Fuel Nozzle

**Application**

- Used in biodiesel fueling

**Features**

- 1-1/2" female NPT
- Design prevents fuel contamination
- Connects to the non-interchange receiver only
- Ball lock design

Description	Part #
ball lock fuel nozzle	FN600BL-NI



C

### Non-Interchange Diesel Fuel Receiver

**Application**

- Used in biodiesel fueling

**Features**

- Design prevents fuel contamination
- Connects to the non-interchange nozzle only
- Ball lock design

Description	Anodized Aluminum Part #
one-piece receiver with cap	FRA-NI-C



## 2" High Volume Diesel Fueling System

**Features**

- Capable of flowing over 400 GPM
- 2" female NPT
- Stainless steel ball lock design
- Removable pull back assembly

**Materials**

- Housing: aluminum
- Non-wear parts: anodized aluminum
- Internal wear components: stainless steel
- Bushings: Delron®

### Diesel Fuel Nozzles

Description	Part #
2" fuel nozzle	FX1500 <sup>1</sup>
2" fuel nozzle - with plug	FX1500P <sup>1</sup>
2" fuel nozzle - with swivel	FX1500S <sup>1</sup>
2" fuel nozzle - with swivel, with plug	FX1500SP <sup>1</sup>
2" sealing plug for nozzle	FX1500PLUG



<sup>1</sup> Must be used with high flow fuel vents found on page 112

### Diesel Fuel Receivers

Description	Part #
2" diesel fuel receiver	FRX
2" fuel receiver with cap	FRX-C
2" cap for receiver	wFRXCAP



### FloMAX Diesel Fuel Gravity Fill Receivers



GFR-0



GFR-90

**Feature**

- Used with the FN600 or FN600BL to convert to gravity fueling

Size	Description	Part #
1-3/8"	straight	GFR-0
	45°	GFR-45
	90°	GFR-90
1"	straight	GFR1-0
	45°	GFR1-45
	90°	GFR1-90

### FloMAX Fuel Vents

**Features**

- 2" male NPT
- Billet cap provides superior impact resistance
- Easily serviced all metal construction
- Rigid ball cage for positive seal
- Available with: threaded outlet, half coupling, and anti-vandalism mounting



VT

VTT

Description	Part #
vent with 5" tube	VT
vent with 7" tube	VT7
vent with 9" tube	VT9
vent with 5" tube and threaded outlet	VTT

### FloMAX High Flow Fuel Vents

**Feature**

- 7" tubes are available, contact Dixon® for more information



Description	Part #
high flow fuel vent with 5" tube	VTX
high flow fuel vent with 9" tube	VTX-9

### FloMAX Diesel Fuel Swivels

**Features**

- Stainless steel male threaded base and ball bearings
- Hard black anodized female threaded nut
- Fluorosilicone sealing O-rings



FNS - standard



FNSID - double

Thread Size	Description	Part #
1-1/2" male NPT x 1-1/2" female NPT	standard	FNS
2" male NPT x 1-1/2" female NPT	standard	FNS2
1-1/2" female NPT x 1-1/2" female NPT	double	FNSID
1-1/2" male NPS x 1-1/2" female NPT	standard	FN600S <sup>1</sup>

<sup>1</sup> Used with FN600 or FN600BL

### FloMAX Service Box

**Features**

- Designed to enclose receivers for diesel fuel, hydraulic oil, transmission fluid, and coolant, reducing contamination and weather-related problems.
- Normally installed on heavy duty earth mover equipment and drill rigs
- 12 gauge steel construction with heavy duty hinges
- Painted with Imron® Primer



receivers sold separately

Part #
FSB

NOTE: No longer available once stock is depleted.

## FloMAX Standard-Series Connectors

### Features

- Standard series connectors consist of four color-coded mating connectors
- All-metal construction with stainless steel wear components and anodized aircraft grade aluminum non-wear components
- Easily recognizable labeling
- Fully compatible and interchangeable with industry standards

C

### Engine Oil Nozzles

#### Features

- Bright red
- Universally fits both R-series and Standard series crankcase receivers
- Incorporates 10 locking balls with a 40% deeper engagement
- Resistant to clogging with a greater ease of cleaning
- Smooth actuation
- Larger diameter pullback lanyard

Male Thread	Description	Anodized Aluminum Part #
3/4" NPT	engine nozzle ball lock	ENBL
	engine nozzle ball lock with plug	ENBL-P
---	engine nozzle plug	ENBL-PLUG



### Engine Oil Receivers

Male Thread	Description	Anodized Aluminum Part #
3/4" NPT	engine receiver	ERS
	engine receiver with cap	ERS-C
---	engine receiver cap	ERS-CAP
3/4" JIC	engine receiver with JIC bulkhead base	ERJ
	engine receiver with JIC bulkhead base and cap	ERJ-C



ERS-C



ERJ-C

### Coolant Fluid Nozzles

#### Features

- Bright teal
- Standard roll-pin locking mechanism
- Ergonomically engineered pullbacks and caps

Male Thread	Description	Anodized Aluminum Part #
1/2" NPT	coolant nozzle ball lock	CN
	coolant nozzle ball lock with plug	CN-P
---	coolant nozzle plug	CN-PLUG



### Coolant Fluid Receivers

Male Thread	Description	Anodized Aluminum Part #
1/2" NPT	coolant receiver	CR-S
	coolant receiver with cap	CR-C
---	coolant receiver cap	CR-CAP

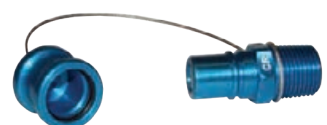

**FloMAX Standard-Series Connectors**

**Hydraulic Oil Nozzles**

**Features**

- Bright gold
- 10 steel dog latching mechanism
- Ergonomically engineered pullbacks and caps



Female Thread	Description	Anodized Aluminum Part #
3/4" NPT	hydraulic nozzle	HN
	hydraulic nozzle with plug	HN-P
---	hydraulic nozzle plug	HN-PLUG

**Hydraulic Oil Receivers**



Male Thread	Description	Anodized Aluminum Part #
3/4" NPT	hydraulic receiver	HR
	hydraulic receiver with cap	HR-C
---	hydraulic receiver cap	HR-CAP

**Transmission Fluid Nozzles**

**Features**

- Bright violet
- 6 steel dog latching mechanism
- Ergonomically engineered pullbacks and caps



Male Thread	Description	Anodized Aluminum Part #
1/2" NPT	transmission nozzle	TN
	transmission nozzle with plug	TN-P
---	transmission nozzle plug	TN-PLUG

**Transmission Fluid Receivers**



Female Thread	Description	Anodized Aluminum Part #
3/8" NPT	transmission receiver	TR
	transmission receiver with cap	TR-C
---	transmission receiver cap	TR-CAP

## FloMAX R-Series Connectors

### Features

- Fully compatible and interchangeable with industry standards
- All-metal construction using anodized aircraft grade aluminum non-wear components
- Standard roll-pin locking mechanism
- Ergonomically engineered pullbacks and caps

C

### Feature

- Bright red

### Engine Oil Nozzles

Female Thread	Description	Anodized Aluminum Part #
3/4" NPT	R-series engine nozzle	R-EN
	R-series engine nozzle with plug	R-EN-P
---	R-series engine nozzle plug	R-EN-PLUG



### Engine Oil Receivers

Male Thread	Female Thread	Description	Anodized Aluminum Part #
1.625-12 UN-2A	1.312-12 UN-2B	R-series engine receiver	R-ER
		R-series engine receiver with cap	R-ER-C
---	---	R-series engine receiver cap	R-ER-CAP

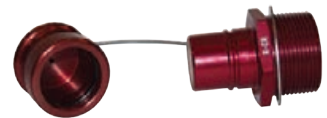

### Coolant Fluid Nozzles

### Feature

- Bright teal

Female Thread	Description	Anodized Aluminum Part #
1/2" NPT	R-series coolant nozzle	R-CN
	R-series coolant nozzle with plug	R-CN-P
---	R-series coolant nozzle plug	R-CN-PLUG



### Coolant Fluid Receivers

Male Thread	Female Thread	Description	Anodized Aluminum Part #
1.187-12 UN-2A	.875-14 UN-2B	R-series coolant receiver	R-CR
		R-series coolant receiver with cap	R-CR-C
---	---	R-series coolant receiver cap	R-CR-CAP



**FloMAX R-Series Connectors**

**Hydraulic Oil Nozzles**

- Feature**  
 • Bright gold

C



Female Thread	Description	Anodized Aluminum Part #
1" NPT	R-series hydraulic nozzle	R-HN
	R-series hydraulic nozzle with plug	R-HN-P
---	R-series hydraulic nozzle plug	R-HN-PLUG

**Hydraulic Oil Receivers**



Male Thread	Female Thread	Description	Anodized Aluminum Part #
1.875-12 UN-2A	1.625-12 UN-2B	R-series hydraulic receiver	R-HR
		R-series hydraulic receiver with cap	R-HR-C
---	---	R-series hydraulic receiver cap	R-HR-CAP

**Transmission Fluid Nozzles**

- Feature**  
 • Bright violet



Female Thread	Description	Anodized Aluminum Part #
3/4" NPT	R-series transmission nozzle	R-TN
	R-series transmission nozzle with plug	R-TN-P
---	R-series transmission nozzle plug	R-TN-PLUG

**Transmission Fluid Receivers**



Male Thread	Female Thread	Description	Anodized Aluminum Part #
1.312-12 UN-2A	1.062-12 UN-2B	R-series transmission receiver	R-TR
		R-series transmission receiver, with cap	R-TR-C
---	---	R-series transmission receiver cap	R-TR-CAP

### FloMAX High Flow 3/4"-Series Connectors

**Features**

- 6 nozzle and receiver sets color-coded for quick identification of mating parts; each color nozzle and receiver only couples with matching color component, providing complete protection against cross contamination

**Specifications**

- Maximum flow rate: **50 GPM at 40 PSI**
- Working pressure rating: **200 PSI**

**Nozzles**

Male Thread	Description	Anodized Aluminum Part #
3/4" NPT	red nozzle with plug	ENBL-P
	gold nozzle with plug	ENBL-P2
	teal nozzle with plug	ENBL-P3
	violet nozzle with plug	ENBL-P4
	navy nozzle with plug	ENBL-P5
	copper nozzle with plug	ENBL-P6



**Receivers**

Male Thread	Description	Anodized Aluminum Part #
3/4" NPT	red receiver with cap	ERS-C
	gold receiver with cap	ERS-C2
	teal receiver with cap	ERS-C3
	violet receiver with cap	ERS-C4
	navy receiver with cap	ERS-C5
	copper receiver with cap	ERS-C6



NOTE: ERS series is available with JIC bulkhead base, substitute 'J' for 'S', example: ERJ-C2

### FloMAX High Flow 1" Series Connectors

**Features**

- 7 color-coded nozzle and receiver sets for quick identification of mating parts; nozzle and receiver only couple with matching color component, providing complete protection against cross contamination
- Nozzle/receiver combination has a flow area equivalent to a 1" schedule 80 pipe
- All wear parts are stainless steel; all non-wear parts are colored anodized aircraft grade aluminum
- Standard nozzle mounting: 1" female NPT; receiver: 1" male NPT
- Nozzle incorporates a ball lock mechanism ensuring smooth and reliable operation
- Length: nozzle 3.90" (99 mm), receiver 3.44" (87 mm)
- Nozzle and receiver coupled length: 5.44" (138 mm)
- Diameter: 2.50" (64 mm)
- Hex size: 2" (51 mm)

**Specification**

- Working pressure: **500 PSI** with burst pressure: **1500 PSI**

**Nozzles**

Female NPT	Description	Anodized Aluminum Part #
1"	red nozzle with plug	HFN-P1
	gold nozzle with plug	HFN-P2
	teal nozzle with plug	HFN-P3
	violet nozzle with plug	HFN-P4
	navy nozzle with plug	HFN-P5
	copper nozzle with plug	HFN-P6
	blue/gray nozzle with plug	HFN-P7



**Receivers**

Male NPT	Description	Anodized Aluminum Part #
1"	red receiver with cap	HFR-C1
	gold receiver with cap	HFR-C2
	teal receiver with cap	HFR-C3
	violet receiver with cap	HFR-C4
	navy receiver with cap	HFR-C5
	copper receiver with cap	HFR-C6
	blue/gray receiver with cap	HFR-C7



C

### TTMA-Series Flange Adapters

**Features**

- Simply and easily converts threaded components to a standard TTMA flange configuration
- Solid cast lightweight aluminum design is more durable than welded fabrications
- Design improves flow through adapter
- Compact size reduces the overall space needed to install



**TTMA Flange x Male NPT Adapters**

TTMA Flange	Male NPT	Overall Length	Aluminum Part #
3"	3"	2-1/2"	TTF3AL-3MT
4"	3"	2-1/2"	TTF4AL-3MT
	4"	2-1/2"	TTF4AL-4MT

**TTMA Flange x Extended Length Male NPT Adapters**

TTMA Flange	Male NPT	Overall Length	Aluminum Part #
4"	3"	5-1/2"	TTF4AL-3EMT
	4"	5-1/2"	TTF4AL-4EMT

**TTMA Flange x Female NPT Adapters**

TTMA Flange	Female NPT	Overall Length	Aluminum Part #
4"	3"	2-1/2"	TTF4AL-3FT
	4"	2-1/2"	TTF4AL-4FT

**TTMA Slip-on Socket Weld Flange**

TTMA Flange	Pipe Size	356T6 Aluminum Part #
4"	4"	TTF400SP

**TTMA Slip-on Plate Flange**

TTMA Flange	Pipe Size	Aluminum Part #
4"	4"	TTMA-64

**TTMA Butt-weld Flange**

TTMA Flange	Pipe Size	Thickness	Aluminum Part #
3"	4"	3/8"	TTF3AL
4"	4"	3/8"	TTF4AL

NOTE: For flange dimensions, diagrams, and additional information, please reference [dixonvalve.com](http://dixonvalve.com).



### TTMA Flange Spacer with 1/2" Port

Size	Description	Aluminum Part #
4"	flange spacer with 1/2" female NPT port	TTFS4AL-FP50



### TTMA Flange Extensions

**Application**

- Used on load arms to connect an API load coupler to a load arm

**Features**

- Adds a 6" space between the load arm and the tank truck
- Extension with groove provides a specified parting point to prevent excessive damage to the loading arm

Size	Description	Aluminum Part #
4"	TTMA flange extension	TETF4AL
	TTMA flange extension with groove	TETFG4AL
	TTMA flange extension with 1/2" female NPT port	TETF4ALFP50



TETF4AL



TETFG4AL

NOTE: For flange dimensions, diagrams, and additional information, please reference dixonvalve.com.

### Cam & Groove Adapter x TTMA Flange

**Features**

- Aluminum flanges have a flat face, stainless flanges have a raised face
- Reference dixonvalve.com for flange drilling standards
- Pressure rating is based on the seal of the mating part, see ratings on page 20

Size	356T6 Aluminum Part #	316 Stainless Steel Part #
2" x 3"	2030-ALT-AL	---
3"	300-ALT-AL	300-ALT-SS <sup>1</sup>
3" x 4"	3040ALTAL	---
4"	400-ALT-AL	400-ALT-SS <sup>1</sup>
6"	600-ALT-AL	---



<sup>1</sup> Parts are produced as a welded fabrication

### Cam & Groove Coupler x TTMA Flange

**Features**

- Supplied standard with a nitrile rubber gasket, other gaskets available on pages 68 - 71
- Use Dixon® replacement handles only

Size	356T6 Aluminum Part #
3"	300-DLT-AL
3" x 4"	3040DLTAL
4"	400-DLT-AL
6"	600-DLT-AL



NOTE: For flange dimensions, diagrams, and additional information, please reference dixonvalve.com.

### Cam & Groove 22-1/2° Adapter x TTMA Flange

**Feature**

- Pressure rating is based on the seal of the mating part, see ratings on page 20

Size	356T6 Aluminum Part #
4"	40022ALTAL



### Cam & Groove 22-1/2° Coupler x TTMA Flange

**Features**

- Supplied standard with a nitrile rubber gasket, other gaskets available on pages 68 - 71
- Use Dixon replacement handles only

Size	356T6 Aluminum Part #
3"	30022ALTAL
4"	40022DLTAL



NOTE: For flange dimensions, diagrams, and additional information, please reference dixonvalve.com.

Dixon® Vapor Recovery Couplers

C

**Feature**

- Not intended for liquid service; for vapor recovery only



**Materials**

- Body: cast aluminum
- Arms: bronze with stainless steel pins
- Finger rings: plated carbon steel
- Gasket: nitrile rubber



**Coupler with Probe x Adapter**

Coupler Size	Adapter Size	356T6 Aluminum Part #
4"	3"	4030-DAVR-AL



**Coupler with Probe x Coupler with Probe**

Coupler Size	Coupler Size	356T6 Aluminum Part #
4"	4"	400-DDVR-AL



**Coupler with Probe x Hose Shank**

**Applications**

- For use with 3" vapor hose
- Not intended for liquid service; for vapor recovery only



**Features**

- VR4030CS-AL has an FKM O-ring poppet seal
- Dixon replacement handle assemblies will not work on these fittings; contact Dixon for replacements



VR4030CS-AL

**Materials**

- Cast aluminum body
- Arms : bronze
- Pins and finger rings: stainless steel
- Gasket: nitrile rubber



VRC3000AL



4030-CVR-AL

Coupler Size	Hose Shank Size	Description	Part #
3"	3"	---	VRC3000AL
4"	2"	---	4020-CVR-AL
4"	3"	no poppet	4030-CVR-AL
4"	3"	poppet	VR4030CS-AL <sup>1</sup>
4"	3"	floating bridge poppet	VR4030CS-SH <sup>2</sup>
4"	4"	no poppet	400-CVR-AL
4"	4"	floating bridge poppet	VR4040CS-AL <sup>2</sup>

<sup>1</sup> Interchanges with all competitor vapor valves except Civacon #633LVH (special bulb design)



<sup>2</sup> Superior interface with air interlock

**Repair Kits**

Description	Part #
seal repair kit: gasket, machine screw and FKM O-ring	VR4040CSRK1
cam arm repair kit: paddle arm and cam arm pin	VR4040CSRK2

## Dixon® Vapor Recovery Couplers

### Features

- 'Floating bridge' poppet design allows optimal flow
- Machined hose shank ensures easier insertion into hose and better sealing
- Durable, easy-to-couple stainless cam arms
- Big wings ensure contact with air interlock button on tanker helping prevent drive-offs
- Change poppet seal without removing the coupler from the hose
- Secure to hose with traditional band clamps or built in crimp collar
- 4" MNPT version allows for either cam and groove or threaded flange option
- Not intended for liquid service; for vapor recovery only



### Materials

- Seal: Nitrile rubber and FKM

Coupler Size	Description	Aluminum Part #
4"	4" coupler x 4" hose shank	VR4040CS-AL
	4" coupler x 3" 45° hose shank	VR4030CS-AL45
	4" coupler x 4" 45° hose shank	VR4040CS-AL45
	4" coupler x 4" 45° hose shank swivel	VR4040CS-ALS45
	4" coupler x 4" MNPT connection	VR4040CS-4MNPT
	4" coupler x 3" hose shank	VR4030CS-SH



VR4030CS-AL45



VR4040CS-AL

## Bayloc® Vapor Coupler with Locking Handle

### Application

- For use in petroleum loading terminals

### Materials

- Body: aluminum
- Seals: FKM

### Specification

- Maximum operating pressure: 120 PSI

Size	Part #
3"	DBC62LVPR-300



NOTE: Must be used with a 4100FNG series check valve.

### Repair Kits

Description	Part #
handle kit	VRHK
compact handle kit	VRHK-C
seal repair kit	VR4040CSRK1
cam arm repair kit	VR4040CSRK2



VRHK

### Coupler x Female NPT

### Feature

- Not intended for liquid service, for vapor recovery only



### Materials

- Body: cast aluminum
- Arms: bronze with stainless steel pins
- Finger rings: plated carbon steel
- Gasket: nitrile rubber

Coupler Size	Female NPT Size	356T6 Aluminum Part #
4"	3"	4030-DVR-AL
	4"	400-DVR-AL

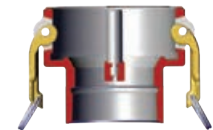

## EZ Boss-Lock Vapor Recovery Coupler with Probe x TTMA Flange



### Materials

- Body: 356T6 aluminium
- Arms: stainless steel EZ Boss-Lock
- Gasket: nitrile rubber

Coupler Size	Flange Size	356T6 Aluminum Part #
4"	4"	ADLTVR400EZ



**TTMA Flange Gaskets**

C





Size	O.D.	I.D.	Thick.	Material	Part #
2"	4-1/2"	2-5/8"	1/8"	Baylast™	200GTTFBL
	5-5/8"	3-1/2"	1/8"	Cork / Nitrile rubber	300GTTFCB
	5-5/8"	3-1/2"	1/16"	PTFE envelope with Klinger filler	300GTTFTK
3"	5-5/8"	3-1/2"	1/8"	Klingersil® C-4300	300GTTFK
	5-29/32"	3-1/2"	3/32"	PTFE with fiber core	40321TF
	7-1/4"	5"	5/32"	PTFE with soft fiber core	40364TF
	7-1/4"	5"	1/8"	Baylast	40364BL
	5-5/8"	3-5/8"	1/8"	Baylast	300GTTFBL
4"	6-5/8"	4-9/16"	1/8"	Cork / Nitrile rubber	400GTTFCB
	6-5/8"	4-9/16"	1/16"	PTFE envelope with Klinger filler	400GTTFTK
	6-5/8"	4-9/16"	1/8"	Klingersil C-4401	400GTTFK
	6-7/8"	4-9/16"	3/32"	PTFE with fiber core	40322TF
	8-3/8"	5-7/8"	5/32"	PTFE with soft fiber core	40323TF
	8-1/4"	5-7/8"	1/8"	Baylast	40323BL
	6-5/8"	4-5/8"	1/8"	Baylast	400GTTFBL

NOTE: For flange dimensions, diagrams, and additional information, please reference [dixonvalve.com](http://dixonvalve.com).

**Sight Flow Indicators**

**Features**

- Due to the proprietary blending of petroleum products, Dixon® recommends that thermoplastic tubing and gaskets be immersion tested in the product to be handled to ensure compatibility (not compatible with crude oil) 
- For dimensional information on tank truck flange drilling, reference [dixonvalve.com](http://dixonvalve.com)
- Maximum flange bolt torque is 200 in-lb (inch pounds) 

**TTMA Flanged Short Sight Flow Indicators**

**Features**

- Durable cast aluminum housing, replaces competitions all acrylic sight glass as commonly found on tank trucks
- Allows for visual identification of the fuel grade prior to opening the valve
- Works with tank truck flanged butterfly valves found on gasoline trucks
- Low-cost sight glass tube can be easily replaced



**Specification**

- Rated to **150 PSI**

Size	Width	Aluminum Part #
3"	1-3/4"	5200-SFI-3
4"	1-3/4"	5200-SFI

**TTMA Flanged Sight Flow Indicators**

**Features**

- Allows for visual identification of the fuel grade prior to opening the valve
- Works with tank truck flanged butterfly valves found on gasoline trucks
- Larger I.D. 4-3/8" flow indicator allows tank truck flanged butterfly valves to connect to either end of the indicator



**Specification**

- Pressure rating: **150 PSI**

Size	Width	I.D.	Aluminum Part #
4"	3-1/4"	4-3/8"	5201-SFI

**Features**

- Allows for visual identification of the fuel grade prior to opening the valve
- 4" flow diameter



Size	I.D.	Aluminum Part #
4"	4-3/8"	4-1460-AL

NOTE: For flange dimensions, diagrams, and additional information, please reference [dixonvalve.com](http://dixonvalve.com).

### TTMA Flanged Sight Flow Indicators

Size	Nominal Width	Acrylic Part #
3"	1-3/4"	TT3ASG
4"	1-3/4"	TT4ASG
3"	1-3/4"	TT3ASG-ETH <sup>1</sup>
4"	1-3/4"	TT4ASG-ETH <sup>1</sup>

#### Optically Enhanced Sight Glass

Size	Nominal Width	Acrylic Part #
3"	1-3/4"	TT3ASGOE
4"	1-3/4"	TT4ASGOE
3"	1-3/4"	TT3ASG-ETHOE <sup>1</sup>
4"	1-3/4"	TT4ASG-ETHOE <sup>1</sup>

<sup>1</sup> For use with ethanol

NOTE: For flange dimensions, diagrams, and additional information, please reference [dixonvalve.com](http://dixonvalve.com).



C

### Sight Flow Indicator Repair Kits

Description	Used on	Part #
3" replacement sight glass, Baylast™ O-ring and retainer ring kit	---	5200-SFI-3-RK1
3" replacement sight glass, FKM O-ring and retainer ring kit	---	5200-SFI-3V-RK1
4" replacement sight glass, Baylast O-ring and retainer ring kit	---	5200-SFI-RK1
4" replacement sight glass, FKM O-ring and retainer ring kit	---	5200-SFIV-RK1
replacement Baylast O-rings, sight glass and retaining ring	5201-SFI	5201-SFI-RK1
Nitrile rubber O-ring	---	O249BU
plexiglass insert	---	4PSG
Nitrile rubber O-ring	---	O246BU



5200-SFIV-RK1

### TTMA Flange Screen

**Feature**

- Stainless steel screen is encapsulated in an FKM gasket

Size	Description	Stainless Steel Part #
4"	screen with 1" square holes	TTFS4SS

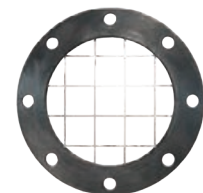

NOTE: For flange dimensions, diagrams, and additional information, please reference [dixonvalve.com](http://dixonvalve.com).

C

### Railroad Tank Car Connections

**Features**

- All swivel nuts have standard 5" Railroad Tank Car thread
- Supplied with a nitrile rubber gasket in the threaded end, other gaskets available on page 127
- Also available in other materials and in 2" and 2-1/2" sizes, consult Dixon® for pricing and availability

**Style A**



Male Adapter	Swivel Nut	Elbow	316 Stainless Steel Part #	Aluminum Part #
3"	5"	120°	RTCA30	---
4"	5"	110°	RTCA40 <sup>1</sup>	ATCA40

<sup>1</sup> Parts are produced as a welded fabrication

NOTE: Stainless steel railroad tank car connections are not compatible with aluminum and brass.



**Style F**

**Features**

- 4" TTMA flange can be bolted to sight glass; API adapter or other dry disconnect
- Supplied with PTFE nitrile rubber envelope gasket



110° elbow

TTMA Flange	Swivel Nut	Elbow	Aluminum Part #
4"	5"	110°	ATCF40 <sup>1</sup>
	5"	90°	ATCF40-90

<sup>1</sup> Part is produced as a welded fabrication

NOTE: For flange dimensions, diagrams, and additional information, please reference [dixonvalve.com](http://dixonvalve.com).

**Style GF**

**Feature**

- 4" TTMA flange can be bolted to sight glass; API adapter or other dry disconnect



110° elbow

TTMA Flange	Boss-lock Coupler	Elbow	Aluminum Part #
4"	4"	110°	ATCGF40
	4"	90°	ATCGF40-90

NOTE: For flange dimensions, diagrams, and additional information, please reference [dixonvalve.com](http://dixonvalve.com).

**Screen**

**Features**

- Stainless steel screen encapsulated in a nitrile rubber gasket
- For use in Style GF elbows



Size	Hole Size	316L Stainless Steel Part #
4"	1"	400-G-BUSS

**Style S**



Shank Size	Swivel Nut	Elbow	Aluminum Part #
4"	5"	110°	ATCS40

### Railroad Tank Car Connections

#### Style T

Male NPT	Swivel Nut	Elbow	Iron Part #	Aluminum Part #
3"	5"	120°	TCT30	ATCT30
4"	5"	110°	TCT40	ATCT40



C

#### Style T

Male NPT	Swivel Nut	Elbow	316 Stainless Steel Part #
3"	5"	120°	RTCT30
4"	5"	110°	RTCT40



NOTE: Components that make up these assemblies are not interchangeable between stainless steel and the other materials.



#### Dixon® Coupler x Tank Car Thread

##### Features

- Part is produced as a welded fabrication
- Pressure rating is based on the seal of the mating part, see ratings on page 20
- Use Dixon replacement handles only

Coupler	Male Tank Car Thread	Aluminum Part #
4"	5"	400DWX5TC



#### EZ Boss-Lock x Coupler Tank Car Thread

##### Features

- Part is produced as a welded fabrication
- Pressure rating is based on the seal of the mating part, see ratings on page 20
- Use EZ Boss-Lock replacement handles only

Coupler	Male Tank Car Thread	Aluminum Part #
4"	5"	AD400ALEZMTC



## Railroad Unloading Assemblies

C

**Features**

- Robust aluminum body construction
- Removable, easy-carry handle
- Safe and reliable - valves will not open unless fittings are properly connected
- Multiple configurations available; consult Dixon® for pricing and availability



**Assembly with Dixon MannTek Dry Disconnect Adapter**

Adapter Size	Swivel Nut Size	Aluminum Part #
4"	5"	ATC40ASSDDA



**Assembly with API Adapter**

**Feature**

- Stainless steel springs on the adapter and coupler for corrosion resistance

Adapter Size	Swivel Nut Size	Aluminum Part #
4"	5"	ATC40ASSAPI

## Dixon Tank Car Adapters



rocker lug



pin lug

**Features:**

- Standard 5" Railroad Tank Car thread
- Supplied with a nitrile rubber gasket in the threaded end; see next page for more gaskets

Size	356T6 Aluminum Part #	Brass Part #	Iron Part #	316 Stainless Steel Part #
2"	200-TCA-AL	---	---	200-TCA-SS
3"	300-TCA-AL	300-TCA-BR	300-TCA-MI	300-TCA-SS
4"	400-TCA-AL	400-TCA-BR	---	400-TCA-SS

NOTE: Stainless steel adapters are not compatible with the aluminum and brass adapters.



## 45° Swivel



**Features**

- Standard 5" Railroad Tank Car thread
- 45° tank car swivel adapter
- Unit has a long handle brass swivel nut and a swivel retaining ring
- Supplied with a nitrile rubber gasket in the threaded end; see next page for more gaskets

Size	356T6 Aluminum Part #
4"	40A-45TCAL

NOTE: 4" hose fittings for railroad tank car unloading can be found on pages 124 - 125.



## Railroad Tank Car Gaskets

### Old Style

**Feature**

- For use with Dixon® fittings

Size	O.D.	I.D.	Thick	Leather Part #
5"	5-1/4"	3-1/2"	3/16"	G9



C

### Standard

**Feature**

- For use with Dixon fittings

Size	O.D.	I.D.	Thick	Material	Part #
5"	5-1/4"	3-7/8"	1/8"	Nitrile rubber	500GTCABU
	5-1/4"	3-7/8"	1/8"	FKM	500GTCAVI
	5-1/4"	3-7/8"	1/8"	fuel grade nitrile rubber	500GTCABF
	5-5/16"	3-7/8"	3/16"	FKM	500GTCAVITHK



### PTFE Envelope

**Features**

- For use with Dixon fittings
- May be too thick for insertion in some older Dixon fittings

Size	O.D.	I.D.	Thick	Material	Part #
5"	5-1/4"	3-13/16"	3/16"	PTFE with nitrile rubber filler	500GTCATF
	5-1/4"	3-13/16"	3/16"	PTFE with FKM filler	500GTCATV



## Pin Lug Wrench

**Feature**

- Used on aluminum and iron tank car nuts

Iron Part #
G10



## Swivel Joints

### Applications

- Used wherever a leak-proof swivel connection is needed in pipelines or in combination with hoses to eliminate hose twisting
- Industries range from petroleum, petrochemical, refining, mining, distilling, paint, farm irrigation and fertilizing, wastewater treatment plants, and food and beverage process equipment. Dixon® swivel joints are found in blending plants, drum filling applications, fluid and dry bulk transfer, vacuum trucks, oil and gas trucks and water trucks. Larger swivels can be found in the steel industry, marine bulk transfer, and many more applications.

### Features

- Full 360° rotational movement
- Wide spacing between dual ball bearing raceways ensures greater load bearing capacity
- Precision-machined design ensures alignment and years of trouble-free service
- O-ring dust seal protects the ball races and seals chamber from outside elements
- Radius elbow design ensures a smooth flow pattern
- Hydrostatic testing is performed on all swivels before shipment

### Options Available

- End configurations: female NPT, 150# flanges, TTMA flange, grooved, weld end, and many other variations
- Seal options: Nitrile rubber, FKM, PTFE, EPDM, FDA nitrile rubber, FFKM
- Ball bearing materials: carbon steel, 440 stainless steel, and 316 stainless steel
- Grease materials: Lithium, FDA approved/food grade, and silicone
- Swivels that include oxygen, steam or submerged service can be specifically designed for unique applications (special order)
- 100% full penetration weld
- Re-build kits available
- Custom swivel options available; contact Dixon® at 888.226.4673

Swivel configurator available [dixonvalve.com](http://dixonvalve.com)

### Typical Applications

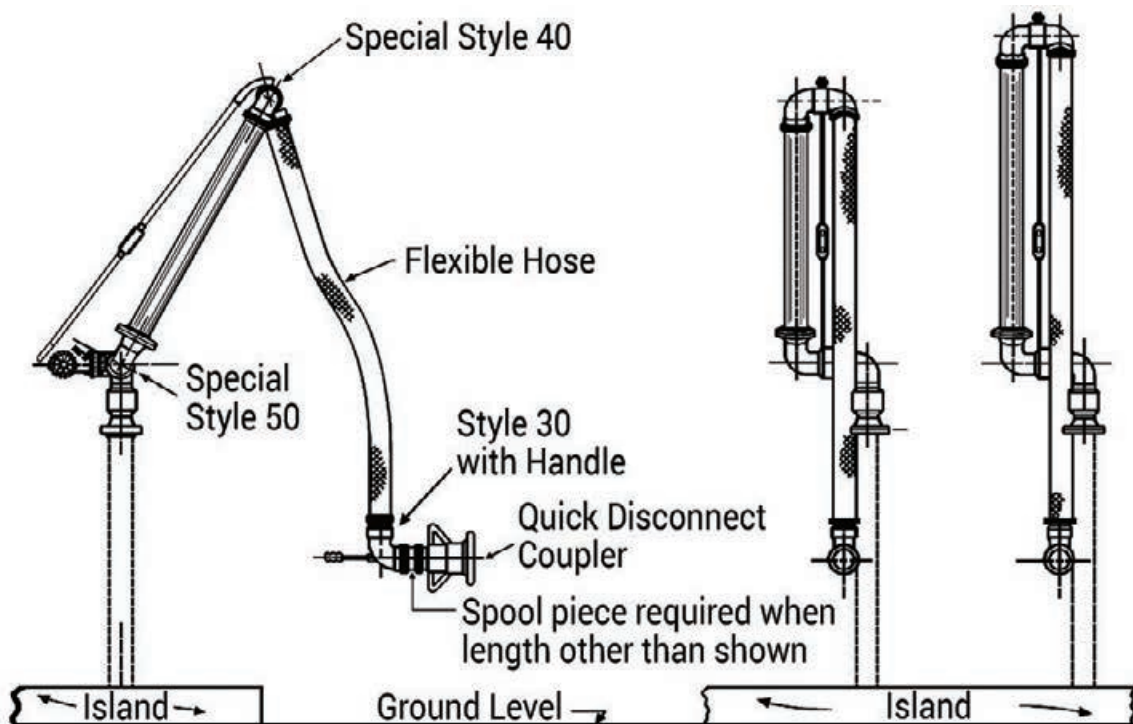

## O-Ring Swivel Joints

### Applications

- Commonly used in aluminum loading/unloading arm applications

### Sizes

- 1" - 4"

### Features

- O-ring pressure seal ensures a leak-proof seal and smooth rotation with lower torque
- Smooth moving seal for high-volume drum and tote loading
- Swivel end configurations: 150 lb. and 300 lb. flanges, FNPT, MNPT, butt weld, TTMA, and others upon request

### Materials

- Available in carbon steel, 316L stainless steel, aluminum, brass, and malleable iron

### Specification

- Available working pressure ratings up to **1,000 PSI**

### Bill of Materials

1. O-ring (dust) seal
2. Ball retainer screw
3. Grease fitting
4. O-ring (pressure) seal
5. Ball bearings
6. Sleeve
7. Body

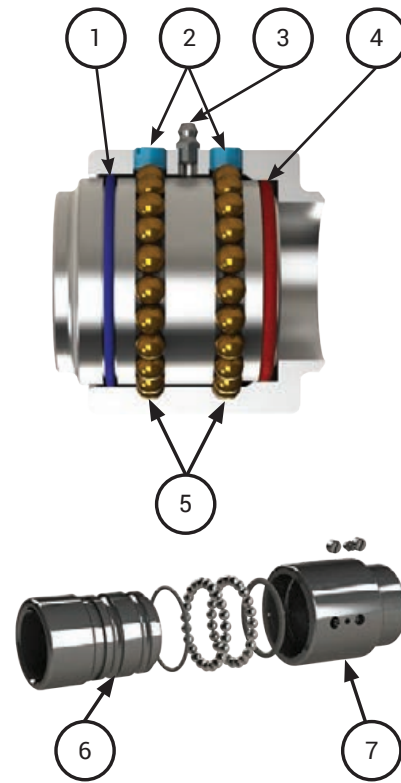

C

## V-Ring Swivel Joints

### Applications

- V-ring, also known as chevron packing, is a multiple lip seal known for its reliability and long life
- Designed to seal even under misalignment caused by race wear from years of service

### Sizes

- 2" - 12"

### Features

- Three lip seals and the ability to seal even if the unit is in misalignment result in longer time between service periods, increasing up-time efficiencies, and lowering maintenance costs
- Spring-loaded triple V-ring sealing system ensures a leak-proof seal at high or low pressure and extends seal life
- Swivels are shipped standard with the following:
  - Nitrile rubber pressure seals and dust seals
  - Carbon steel ball bearings
  - PTFE retainers in V-ring swivels

### Materials

- Carbon steel, 316L stainless steel, and aluminum

### Specification

- Available working pressure ratings up to **1,000 PSI**

### Bill of Materials

- |                           |                        |
|---------------------------|------------------------|
| 1. Body                   | 6. Spring retainer     |
| 2. Sleeve                 | 7. Spring              |
| 3. Ball bearings          | 8. Ball retainer screw |
| 4. Seal retainer          | 9. Grease fitting      |
| 5. V-ring (pressure) seal | 10. O-ring (dust seal) |

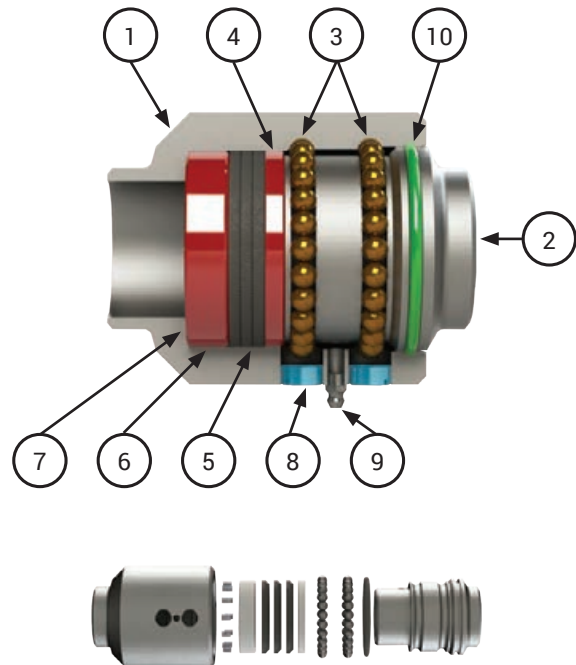

**Single Plane Style 20**



female NPT x female NPT

Size	Aluminum Part #	Malleable Iron Part #
1-1/2"	15020FXFAL00000	15020FXFMI00000
2"	220FXFAL00000	220FXFMI00000
3"	320FXFAL00000	320FXFMI00000
4"	420FXFAL00000	---

**Single Plane Style 30**



female NPT x female NPT

Size	Aluminum Part #	Malleable Iron Part #
1-1/2"	15030FXFAL00000	15030FXFMI00000
2"	230FXFAL00000	230FXFMI00000
3"	330FXFAL00000	330FXFMI00000
4"	430FXFAL00000	---

NOTE: Contact Dixon® at 888.226.4673 for additional sizes, materials and configurations

**Swivel Joint Styles Planes of Rotation**

**Single Plane Style 40**



female NPT x female NPT



150# ASA flange x 150# ASA flange

**Double Plane Style 50**



female NPT x female NPT



150# ASA flange x 150# ASA flange

**Double Plane Style 60**



female NPT x female NPT



150# ASA flange x 150# ASA flange

Swivel configurator available [dixonvalve.com](http://dixonvalve.com)

## Swivel Joint Styles Planes of Rotation

### Double Plane Style 70



female NPT x female NPT



150# ASA flange x 150# ASA flange

C

### Triple Plane Style 80



female NPT x female NPT



150# ASA flange x 150# ASA flange

### Triple Plane Style 10

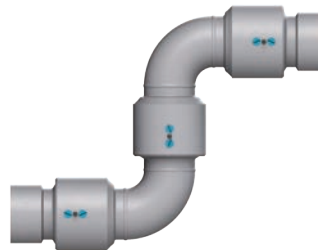

female NPT x female NPT

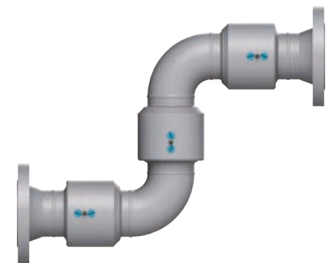

150# ASA flange x 150# ASA flange

### Working Pressures

Dixon® swivels are recommended for use at the following maximum Non-Shock Cold Working Pressures (NSCWP) provided in **PSI**, at ambient temperatures **70°F (21°C)**.

Size	V-ring Carbon Steel CS	O-ring Carbon Steel OC	V-ring Stainless Steel SS	O-ring Stainless Steel OS	Aluminum AL	Brass BR	Malleable Iron MI
1"	---	1000	---	1000	150	---	---
1-1/4"	---	---	---	---	150	---	---
1-1/2"	---	1000	---	1000	150	300	600
2"	1000	1000	1000	1000	150	300	600
3"	1000	1000	1000	1000	150	300	600
4"	1000	---	1000	---	150	---	---
6"	1000	---	---	---	150	---	---
8"	---	---	---	---	150	---	---

- When using flanged ends, the pressure rating will be reduced to coincide with that of the flange being used. Carbon steel and stainless steel 150# flanges are recommended for use at **275 PSI** maximum at ambient temperature **70°F (21°C)**.
- Lubrication should be performed periodically, depending on service and operating conditions. Twice yearly is normally sufficient.
- All dimensions are approximate. Where critical, contact Dixon at 888.226.4673

Swivel configurator available [dixonvalve.com](http://dixonvalve.com)

## Swivel Ordering Information

Size
Style (shape)
End configuration
Material
Maximum working pressure
Temperature range
Media: specify product being handled (if chemical, advise concentration)
Submerged or oxygen service
If for constant rotation, advise RPM
If for suction service, advise maximum vacuum in inches of mercury (Hg)

Our Sales and Engineering staff will help you evaluate your swivel application: please call 888.226.4673.

Example:  $\frac{2}{[A]}$   $\frac{20}{[B]}$   $\frac{F}{[C]}$  X  $\frac{F}{[C]}$   $\frac{CS}{[D]}$   $\frac{0}{[E]}$   $\frac{0}{[F]}$   $\frac{1}{[G]}$   $\frac{0}{[H]}$   $\frac{0}{[I]}$

A Size					
B Style					
C End Connections	W Weld End	F Female NPT	FG 150# ASA Flange	TF Tank Truck Flange	PF 300# ASA Flange (not available in aluminum)
D Material	CS (V-ring) Carbon Steel OC (O-ring) Carbon Steel	SS (V-ring) Stainless Steel OS (O-ring) Stainless Steel	AL Aluminum	BR Brass	MI Malleable Iron
<b>Code</b>	<b>E Pressure Seal</b>	<b>F Dust Seal</b>	<b>G Retainers</b>	<b>H Ball Bearings</b>	<b>I Grease</b>
0	Nitrile rubber (standard)	Nitrile rubber (standard)	no retainers (O-ring swivel)	carbon steel (Standard)	Lithium
1	FKM	FKM	---	440 grade SS	FDA approved/ food grade
2	PTFE	---	PTFE <sup>1</sup>	316 grade SS	Silicone (required with EPR seals)
3	Ethylene Propylene	Ethylene Propylene	---	---	---
4	(requires silicone grease)	(requires silicone grease)	---	---	---

<sup>1</sup> Aluminum retainers are no longer available. PTFE retainers will be standard for all V-ring swivels.

The swivel should be packed such that the surfaces coming in contact with the fluid being handled are compatible with that fluid. In a case where the swivel is being used in a submerged service, this would include the dust seals and ball bearings. We always recommend the use of the stainless steel ball bearings when building a swivel for submerged service. Standard carbon steel ball bearings could rust together, making it impossible to disassemble the swivel and, which may affect operation.



Swivel configurator available [dixonvalve.com](http://dixonvalve.com)

## Loading Arm Swivels

### Features

- TTMA-flanged loading arm swivel with heavy-duty D-style shovel handle
- Shovel handle is used to guide the connection of the API load coupler to the adapter on the tank truck
- Long radius elbow improves the flow into the API load coupler and provides spacing between the load arm and the tank truck
- FKM-A swivel seals are compatible with ethanol blended fuel
- Can be used with flange extensions
- TTMA flanges on both ends



style 30, short radius

C



style 30, long radius

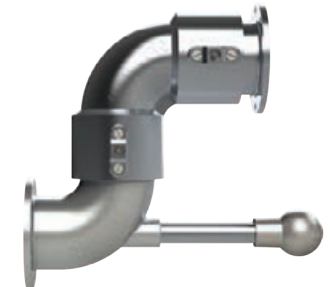

style 50

Description	Handle	Seal	3" Part #	4" Part #
style 20	no handle	Nitrile rubber	320TFXTFAL00000	420TFXTFAL00000
		FKM-A	320TFXTFAL11000	420TFXTFAL11000
style 30 short radius	D-handle	Nitrile rubber	33HTFXTFAL00000	43HTFXTFAL00000
		FKM-A	33HTFXTFAL11000	43HTFXTFAL11000
	ball handle	Nitrile rubber	33BTFXTFAL00000	43BTFXTFAL00000
		FKM-A	33BTFXTFAL11000	43BTFXTFAL11000
	no handle	Nitrile rubber	330TFXTFAL00000	430TFXTFAL00000
		FKM-A	330TFXTFAL11000	430TFXTFAL11000
style 30 long radius	D-handle	Nitrile rubber	---	43HTFTFLAL00000
		FKM-A	---	43HTFTFLAL11000
	ball handle	Nitrile rubber	---	43BTFTFLAL00000
		FKM-A	---	43BTFTFLAL11000
	no handle	Nitrile rubber	---	430TFTFLAL00000
		FKM-A	---	430TFTFLAL11000
style 40	D-handle	Nitrile rubber	34HTFXTFAL00000	44HTFXTFAL00000
		FKM-A	34HTFXTFAL11000	44HTFXTFAL11000
	ball handle	Nitrile rubber	34BTFXTFAL00000	44BTFXTFAL00000
		FKM-A	34BTFXTFAL11000	44BTFXTFAL11000
	no handle	Nitrile rubber	340TFXTFAL00000	440TFXTFAL00000
		FKM-A	340TFXTFAL11000	440TFXTFAL11000
style 50	D-handle	Nitrile rubber	35HTFXTFAL00000	45HTFXTFAL00000
		FKM-A	35HTFXTFAL11000	45HTFXTFAL11000
	ball handle	Nitrile rubber	35BTFXTFAL00000	45BTFXTFAL00000
		FKM-A	35BTFXTFAL11000	45BTFXTFAL11000
	no handle	Nitrile rubber	350TFXTFAL00000	450TFXTFAL00000
		FKM-A	350TFXTFAL11000	450TFXTFAL11000

### Type 35 Loading Arm Swivel Replacement Parts

Description	Part #
4" schedule 80 aluminum nipple	ATN100X7
ball-style handle	100BHAN-AL
D-Style heavy-duty shovel handle	100DHAN-AL
Nitrile rubber seal kit	4RK0BU
FKM-A seal kit	4RKOVIVI



**TTMA Flange Extensions**

C



TETF4AL



TETFG4AL

**Applications**

- Used to connect an API coupler to a loading arm
- Provides a specified parting point to prevent excessive damage to the loading arm

**Features**

- Adds a 6" space to allow for clearance between the loading arm and the tank truck
- Color coded for product identification
- Other colors available upon request. Consult Dixon® for more details

**Materials**

- Aluminum, powder coated aluminum



TETF4AL-W



TETF4AL-B



TETF4AL-G



TETF4AL-R



TETF4AL-Y



TETF4AL-G/Y



TETF4AL-R/W/B

Size	Description	Part #
4"	TTMA flange extension	TETF4AL
	TTMA flange extension with groove	TETFG4AL
	TTMA flange extension with 1/2" female NPT port	TETF4ALFP50
	TTMA flange extension with 3/4" female NPT port	TETF4ALFP75
	TTMA flange extension	TETF4AL
	TTMA flange extension; color-coded white	TETF4AL-W
	TTMA flange extension; color-coded blue	TETF4AL-B
	TTMA flange extension; color-coded green	TETF4AL-G
	TTMA flange extension; color-coded red	TETF4AL-R
	TTMA flange extension; color-coded yellow	TETF4AL-Y
	TTMA flange extension; color-coded orange	TETF4AL-O
	TTMA flange extension; color-coded black	TETF4AL-BLK
	TTMA flange extension; color-coded combination green and yellow	TETF4AL-G/Y
	TTMA flange extension; color-coded combination blue and white	TETF4AL-B/W
	TTMA flange extension; color-coded combination blue and red	TETF4AL-B/R
	TTMA flange extension; color-coded combination white and red	TETF4AL-W/R
TTMA flange extension; color-coded combination red, white, and blue	TETF4AL-R/W/B	

**TTMA Flange Extension Reducing Spools**



TETF3x4AL

Size	Description	Material	Part #
3" x 4"	TTMA flange extension reducing spool	aluminum	TETF3X4AL
	TTMA flange extension reducing spool	carbon steel	TETF3X4CS
	TTMA flange extension reducing spool	stainless steel	TETF3X4SS



## Dixon® Loading Arms



C

### Applications

- Used in the transfer of liquids and dry bulk in refineries, chemical plants, rail terminals, truck terminals, tote and drum filling, and food industry

### Sizes

- 2", 3", 4", and more upon request

### Features

- Three options for sealing swivels: O-ring, V-ring, and split flange
- Fast delivery for many sizes and styles
- Engineered with easy service in mind
- Wide variety of end configurations available
- Torsion spring counterbalance:
- Ball screw adjustment mechanism for easy and safe adjustment
- Multiple spring rates available for different load requirements
- Multiple grease ports for ease of service

### Materials

- Various materials available including: hardened carbon steel, 316L stainless steel, and aluminum
- Seals: Nitrile rubber, EPDM, FKM A and B, PTFE, Baylast™, and more on request
- Counterbalance housing: steel

NOTE: Visit [dixonvalve.com/loadingarms](http://dixonvalve.com/loadingarms) for additional product information or call 888.226.4673.

C



## Split Flange Swivels

### Applications

- Used in petroleum, blending plants, petrochemical, refining, mining, distilling, paint plants, farm irrigation and fertilizing, wastewater treatment, food and beverage process equipment, and marine

### Features

- Bearing pack design allows easy seal change without removing the ball bearings
- Simple maintenance: remove one nose piece, replace seal pack, reinstall with little down-time
- Instream seal separates wetted area from ball bearings allowing for longer bearing pack life over conventional swivels
- Wide set bearing race for higher moment loads
- Compact design for low profile applications

### Materials

- Bearing pack: through hardened forged high carbon alloy
- Material contact surfaces: stainless steel or carbon steel nose pieces

### Specifications

- Pressure rating: up to **600 PSI**
- Temperature: **-40°F to 450°F (-40°C to 232°C)** depending on seal material (with standard seals: **350°F (177°C)**)

### Available options

- Stock end configurations: 150 lb. and 300 lb. flanges, FNPT, butt weld, others per request
- Stock seals: Baylast™, FKM, PTFE, others per request
- Full penetration weld
- Contact Dixon® at 888-226-4673 for additional materials and configurations

Size	Carbon Steel Weld x Weld with Baylast Pressure Seals Part #	Carbon Steel Weld x Weld with FKM Pressure Seals Part #	Carbon Steel 150# Flange x 150# Flange with Baylast Pressure Seals Part #	Carbon Steel 150# Flange x 150# Flange with FKM Pressure Seals Part #
2"	SF220WXWCS00	SF220WXWCS10	SF220FGXFGCS00	SF220FGXFGCS10
3"	SF320WXWCS00	SF320WXWCS10	SF320FGXFGCS00	SF320FGXFGCS10
4"	SF420WXWCS00	SF420WXWCS10	SF420FGXFGCS00	SF420FGXFGCS10

## Split Flange Swivel Components

### Split Flange Bearing Packs



Size	Carbon Steel Part #
2"	2SFBP
3"	3SFBP
4"	4SFBP

### Split Flange Nose Pieces

#### Feature

- 2 required per bearing pack



Size	Carbon Steel Part #	316 Stainless Steel Part #
2"	2SFNPSCS	2SFNPSSS
3"	3SFNPSCS	3SFNPSSS
4"	4SFNPSCS	4SFNPSSS

### Seal Kits

#### Features

- Kits contains: seal, PTFE retainer, carbon steel bolts
- 1 required per bearing pack



Size	Baylast Part #	FKM Part #	PTFE Part #
2"	2SFSK-BAYLAST	2SFSK-VI	2SFSK-TESS
3"	3SFSK-BAYLAST	3SFSK-VI	3SFSK-TESS
4"	4SFSK-BAYLAST	4SFSK-VI	4SFSK-TESS

### Compact TTMA Handle Kit

**Application**

- For various applications that utilize 4" TTMA connections, allowing for improved ergonomics when handling hoses

**Features**

- Includes Dixon® D-handle
- Lightweight construction

Size	Aluminum Part #
4"	TTMAHK-C



C

### Counterbalance Clamps

**Features**

- Loading arm connecting clamp for counterbalance
- Includes necessary hardware to attach to pipe leg; hardware to attach counterbalance pivot arm bar not included
- Used to connect the pivot arm bar of ESB1 counterbalance units to the base swivel of a loading arm

Size	Material	Part #
2"	stainless steel	ESB-CLAMP-2
3"	ductile iron	ESB-CLAMP-3
4"	ductile iron	ESB-CLAMP-4



## Top Loading Valves

C



TLV-300TFVBVIAL

**Application**

- For use in top loading fuels and other low-viscosity media

**Features**

- BSP threaded vacuum breaker standard
- TTMA flanges on both ends standard
- Manually operated "deadman" style with spring-loaded handle
- Optional remote handle available
- Manual or remote controlled valve mounts before the loading arm leg to allow for flow control

**Materials**

- Valve: aluminum
- Vacuum breaker body: brass
- Vacuum breaker housing: aluminum
- Seals: FKM



AT1350-3

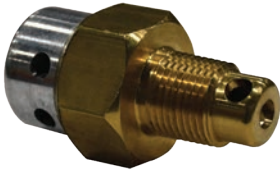

VB-050-BSP

Size	Description	Part #
3"	top loading valve with vacuum breaker	TLV-300TFVBVIAL
4"		TLV-400TFVBVIAL
3"	valve remote, handle, and bracket kit	AT1350-3
4"		AT1350-4
1/2"	vacuum breaker, BSP threads	VB-050-BSP
	vacuum breaker, NPT threads	VB-050-NPT

## Top Loading Diffusers/T-Deflectors

**Application**

- Installed on drop leg of a top-load loading arm to distribute media evenly to help reduce splash

**Features**

- Diffusers distribute media evenly 360°
- T-deflectors distribute media to the sides of the tank, railcar, or tote



TLD-300S



TLTD-400S

Size	Description	Aluminum Part #
3"	360° diffuser	TLD-300S
	T-deflector	TLTD-300S
4"	360° diffuser	TLD-400S
	T-deflector	TLTD-400S

## 5500-Series API Couplers

### Application

- Combined with API adapters, these couplers are suitable for railcar and tank truck loading or unloading

### Features

- Locking five-cam design provides easy alignment and tight connection
- Modular design allows various face seal combinations to be compatible with different alternative fuels, performance levels, and applications
- Shaft seals can be changed without removing coupler from the loading arm
- Fully interlocked collar cannot be opened when connected and cannot be disconnected when opened
- Replaceable seal design while coupler is on loading arm
- 4" TTMA inlet mounting flange connection
- Ball-end handle for easy and comfortable operation
- No special tools needed for maintenance
- Reference [dixonvalve.com](http://dixonvalve.com) for bill of materials and a complete list of repair kits

### Materials

- Body: hard coated anodized 356T6 aluminum
- Shroud: hard coated anodized 356T6 aluminum with stainless steel insert
- Link, shaft, pin, and crank: hardened 17-4PH stainless steel
- Cam: CF8M stainless steel
- Poppet and bearing: Bayloy
- Seals: Baylast™, EPDM, FFKM, FKM-B, FKM-GFLT, fluorosilicone, and Hifluor

### Specifications

- Seal operating temperature:
  - Baylast: -20°F to 250°F (-28°C to 121°C)
  - EPDM: -40°F to 250°F (-40°C to 120°C)
  - FFKM: 0°F to 400°F (-18°C to 204°C)
  - FKM-B: -10°F to 400°F (-23°C to 204°C)
  - FKM-GFLT: -20°F to 400°F (-28°C to 204°C)
  - Fluorosilicone: -50°F to 300°F (-40°C to 149°C)
  - Hifluor: 23°F to 350°F (-5°C to 176°C)
- Flow rate: **600 GPM** at **3 PSI** pressure drop, maximum flow rate: **1,000 GPM**
- Fully compliant with API RP1004:2003 specifications
- Burst tested: **450 PSI**

Description	Seal Material	Part #	Complete Repair Kit <sup>1</sup> Part #	Replaceable Nose Seal Part #
4" API coupler	Baylast	5500BL	5500RK2	5500RK8
	EPDM	5500E	5500RK3	5500RK9
	FFKM	5500K	5500RK6	5500RK12
	FKM-B	5500B	5500RK1	5500RK7
	FKM-GFLT	5500G	5500RK5	5500RK11
	Fluorosilicone	5500F	5500RK4	5500RK10
	Hifluor	5500H	5500RK19	5500RK20

<sup>1</sup> Complete repair kit contains all the seals, pins, and cotter keys to replace all the seals.  
NOTE: Stainless steel handles and locking handle kit options are available please contact Dixon for a quote.

### API Coupler Repair Kits

Description	Part #
small parts kit for 5500 series rack coupler	5500RK21
aluminum replacement handle kit with bolt and nut	5500RK22
stainless steel replacement handle kit with bolt and nut	5500RK23
locking handle kit	5500RK24
aluminum short handle replacement kit with bolt and nut	5500RK25
replacement poppet kit with lins, pins, and cotter pin	5500RK26
replacement seal cylinder - no seal	5500RK27
replacement FKM-GFLT bearing kit for 5500	5500RK51



C

Normal wear and tear items (including seals) not covered<sup>1</sup>

New



5500-Series



Replaceable nose seal: Replace without removal from the loading arm



5500RK24

### Reelcraft® Static Discharge Reel

C



**Application**

- Used to ground equipment in hazardous atmospheres, such as fuel trucks or carts transferring flammable materials. When properly clamped to ground, the static discharge reel dissipates static electrical buildup, reduced the chances of sparking and the potential for explosion.

**Features**

- Supplied with a 3/32" O.D. steel aircraft cable
- DC resistance is approximately one ohm per 50' of steel cable

Description	Stranded Steel Part #
single 7" x 7" stranded steel	G3050

## Overfill Protection Rack Monitors

### Application

- Installed on the gantry to control the loading process of petroleum fuels or other hazardous liquid into cargo tanks

### Features

- Automatically switches between 2-wire or 5-wire type sensors
- Compatible with analog 2-wire thermistor type sensors
- Redundant relay outputs prevent single point failures
- Data management via RS485 port
- Wireless bypass key system
- Ground verification
- Reads trailer identification modules

### Approvals

- Meets API RP1004 and EN13922 standards
- Suitable for Class I, Division 1, Group CD and Class I, Zone 1, and Group IIB



Rack Monitor (FT7000)



Rack Monitor System

C

## FT590-Series Terminal Test Equipment

### Applications

- Verifies terminal overfill monitor performance and read the trailer identification modules
- Displays the unique serial number you need to enter into the terminal automation system

### Features

- Rack monitor testers and mini trailer overfill system have the same API compatible signals
- When connected to the API plug it will cause the terminal overfill monitor to switch permissive
- Tester contains a liquid level sensor, API compatible socket, ground bolt, and trailer identification module, all wired into one unit
- Flotech® FT530 is a self contained microprocessor capable of reading the serial number embedded into the trailer identification module located in the trailer socket



FT590OG



FT590TG



FT530

Description	Part #
rack tester thermistor with ground bolt	FT590TG
rack tester thermistor with ground bolt and trailer identification module	FT590TGT
rack tester optic with ground bolt	FT590OG
rack tester optic with ground bolt and trailer identification module	FT590OGT
trailer identification module reader	FT530

API-Compatible Systems

C



FT7500



FT7501



FT7502



FT600



FT620



FT600P  
with 13-pin plastic



FT620P  
with J560 aluminum

Features

- Plug is color-coded (5-wire optic) blue or (2-wire optic / thermistor) green
- Highly visible safety orange jacket to meet trip hazard requirements
- Cord is bonded mechanically and resistant to abrasion and oil
- Cord sets are interchangeable with Scully and Civacon
- All wiring is compatible with standard Scully color codes and wiring number configurations
- The 9-pin conductor is shielded to be compatible with Scully VIP system
- For mating socket, consult Dixon®

Materials

- Plug body: reinforced nylon
- Button contacts: 316 stainless steel
- All other hardware: stainless steel

Order Guide

Part #	Rack Monitor Description
FT7000	rack monitor, auto switch between 2-wire / 5-wire sensors, ground verification, and trailer identification modules; API RP 1004 / EN13922
<b>Safe-T Connect Junction Box Description</b>	
FT7600	8-pin, 2J, green API plug, and 30' safety orange coiled cable
FT7600-4	8-pin, 4J, green API plug, and 30' safety orange coiled cable
FT7600C	10-pin, 4J, green API plug, and 30' safety orange coiled cable
FT7600P	8-pin, 2J, green API plug, 30' safety orange coiled cable, and Plug-n-Play connector
FT7600S	8-pin, 2J, green API plug, and 20' safety orange straight cable
FT7620	6-pin, 3J, blue API plug, and 30' blue coiled cable
FT7620P	6-pin, 3J, blue API plug, 30' blue coiled cable, and Plug-n-Play connector
FT7620S	6-pin, 3J, blue API plug, and 20' blue straight cable
FT7630	10-pin, 4J, black plug per EN13922, and 30' blue shielded coiled cable
FT7630D	10-pin, 4J, black plug per EN13922, and 30' blue shielded coiled cable with Dixon Bayco® break-away
<b>Junction Box Description</b>	
FT7500	single cord junction box
FT7501	dual cord junction box
FT7502	junction box with Cole Hersee yellow 13-pin break-away
FT7503	junction box with D-type pigtail break-away
<b>Rack Cord Description</b>	
FT600	8-pin, 2J, API thermistor plug, and 30' safety orange coiled cable
FT600-4	8-pin, 4J, API thermistor plug, and 30' safety orange coiled cable
FT600C	10-pin, 4J, API thermistor plug, and 30' safety orange coiled cable
FT600P	8-pin, 2J, API thermistor plug, and 30' safety orange coiled cable with 13-pin Plug-n-Play
FT600S	8-pin, 2J, API thermistor plug, and 20' safety orange straight cable
FT620	6-pin, 3J, API optic plug, and 30' blue coiled cable
FT620P	6-pin, 3J, API optic plug, 30' blue coiled cable and Plug-n-Play connector
FT620S	6-pin, 3J, API optic plug, and 20' blue straight cable
FT630	10-pin, 4J, black plug per EN13922, and 30' blue shielded coiled cable
FT630D	10-pin, 4J, black plug per EN13922, 30' blue shielded coiled cable, and Dixon Bayco break-away



## Dixon® MannTek Safety Break-away Couplings - Industrial Version

### TTMA Flanged Breakaway Couplings

**Features**

- Minimizes spillage and damage associated with drive-away and pull-away incidents
- Installs between an API coupler and loading arm
- Coupling automatically senses excessive load, closes the valves and disconnects, release is executed when force causes the bolts to break
- High flow rate / low pressure drop
- FKM/FPM is standard seal

**Specification**

- 150 PSI at ambient temperature 70°F (21°C)

Size	Aluminum Part #
4"	SBC400ALTTMA
4"	SBC400ALTTMASV

NOTE: For flange dimensions, diagrams, and additional information, please reference [dixonvalve.com](http://dixonvalve.com).



SBC400ALTTMA



SBC400ALTTMASV



API Rack Cord Assemblies

FloTech® Part #	API		Cord		J-Slots			Pins			Breakaway Plug	
	Thermistor	Optic	20' Straight	30' Coiled	2	3	4	6	8	10	Optic J560 Aluminum	Thermistor 13 Pin Plastic
FT600	✓			✓	✓				✓			
FT600-4	✓			✓			✓		✓			
FT600C	✓			✓			✓			✓		
FT600C-2	✓			✓	✓					✓		
FT600P	✓			✓	✓				✓			✓
FT600P-4	✓			✓			✓		✓			✓
FT600S	✓		✓		✓				✓			
FT600SC	✓		✓				✓			✓		
FT600CP	✓			✓			✓			✓		✓
FT600SP	✓				✓				✓			✓
FT605C		✓		✓			✓	✓				
FT620		✓		✓		✓		✓				
FT620P		✓		✓		✓		✓			✓	
FT620X620		✓		✓		✓		✓				
FT620S		✓	✓			✓		✓				

API Rack Cord Parts

FloTech Part #	API		Cord		J-Slots			Pins		
	Thermistor	Optic	20' Straight	30' Coiled	2	3	4	6	8	10
FT601	✓							✓		✓
FT601-4	✓						✓		✓	
FT601-10	✓						✓			✓
FT602	✓			✓						
FT603	✓						✓			
FT604	✓		✓							
FT621		✓					✓	✓		
FT622		✓					✓			
FT623		✓					✓			
FT624		✓	✓	✓		✓				

## A100 Outalarm® with Probe

Dixon® ADSI\* industrial fluid control manufactures products specifically designed for liquid terminal operations. Our standard product offering is shown on the following pages. However, there are numerous additional applications, materials, and custom designs available. For technical information or assistance with ordering these products, please call 513.874.8499 or 877.582.3569 or visit [dixonvalve.com/ADS](http://dixonvalve.com/ADS).

\*Formerly Automated Design Service, Inc.

### Application

- Specifically designed for liquid terminal operation on batch loading and overflow protection, tank cars, tanks trucks, marine barges; suitable for open and closed domes

### Sizes

- 24", 36", 48", and 60" probe lengths standard; other lengths available

### Features

- Totally self-contained; no wires, tubing, or external power
- Rugged weather- and corrosion-resistant construction
- No moving parts, tip sensitive phase shift digital capacitance sensor for conductive and non-conductive fluid; conductivity sensor available for conductive fluids
- Requires no calibration or adjustment
- Adjustable insertion length through a standard 1/2" NPT fitting
- High-intensity audible and flashing visual outputs
- Optional opto-isolated solid state contact output
- Full, hard, graduated, laser-engraved rod
- A100 operates up to 2,500 hours on a single 9V alkaline battery in standby mode
- Fail-safe, continuous battery monitor goes to alarm state on low battery
- Battery current drain <0.23 mA during standby; <60 mA in alarm state

### Materials

- Wetted materials: 316 stainless steel, PTFE standard, other materials available

### Specifications

- Minimum dielectric constant: 1.8
- Temperature range:
  - Capacitance probe: -14°F to 250°F (-26°C to 121°C)
  - High-temp capacitance probe: -14°F to 325°F (-26°C to 163°C)
  - Outalarm® monitor: -40°F to 150°F (-40°C to 65°C)
- Activation point: 1/4" into liquid surface
- Compatible with any liquid or dry bulk material with a dielectric constant of 1.8 or greater
- Horn intensity: 101 dB at 2'
- Light output: three each 3,000 mcd high-intensity red flashing LEDs
- Pressure rating on standard unit: **50 PSI**; consult Dixon® for applications up to **300 PSI**

### Approvals

- Intrinsically safe design per ANSI/UL913 for Class I, Div I Groups A, B, C, and D Hazardous Areas



A100  
Capacitance  
Probe

### A100 Probe

Length	Capacitance 250°F (121°C) Max Part #	Hi-temp Capacitance 325°F (163°C) Max Part #	Conductivity for Conductive Fluids <sup>1</sup> Part #
12"	A100C12A	A100HC12A	A100CSS12A
24"	A100C24A	A100HC24A	A100CSS24A
36"	A100C36A	A100HC36A	A100CSS36A
48"	A100C48A	A100HC48A	A100CSS48A
60"	A100C60A	A100HC60A	A100CSS60A
72"	A100C72A	A100HC72A	A100CSS72A
84"	A100C84A	A100HC84A	A100CSS84A

<sup>1</sup> Material to be sensed must be specified at time of order.

## ADS Spillguard® System

C

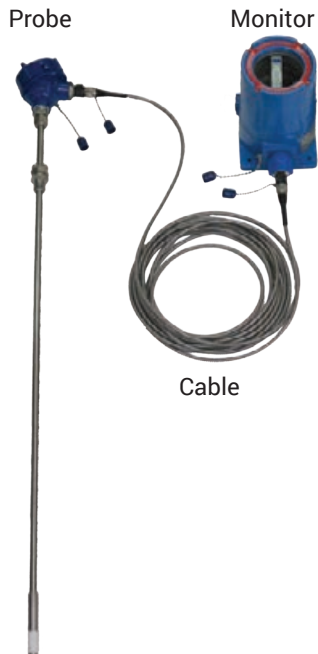

### Applications

- Shutdown and alarm system for tank cars, tank trucks, barges, and ships
- Suitable for open and closed domes

### Sizes

- Standard cable lengths: 15', 25', and 50'; other lengths available
- Insertion lengths: 4" to 60" standard; other lengths available

### Features

- Rugged, explosion-proof, weather-, chemical-, and corrosion-resistant
- LED status lights visible through glass cover
- Inserts into tank through standard 1/2" NPT fitting
- Probe can be portable or permanently installed in the vessel
- Laser engraved graduated rod with 1/4" graduations
- Probe-to-controller cable protected by stainless steel interlocking armor sheath and heavy-duty latching connectors at both ends
- Fail-safe design: unit trips in the event of an open or shorted cable or loss of power
- Choice of capacitance, conductivity, or single-point ultrasonic sensors
- Input power: 120 VAC, 240 VAC, or 24 VDC, 2.5 watts
- Output relay de-energizes on high level, broken, or shorted sensor cables, or loss of power
- Sensor excitation open circuit voltage 8 VDC, short circuit current 8 mA with built-in FM-approved barrier
- Optional self-test feature, tilt and ground verification interlocks, and latching circuit available

### Materials

- Wetted materials: 316 stainless steel and PTFE standard, other materials available
- Controller housing: NEMA 4X, NEMA 7, Explosion Proof, Class I, II, Groups B, C, and D

### Specifications

- Minimum dielectric constant: 1.8
- Temperature range:
  - Capacitance probe: -14°F to 250°F (-26°C to 121°C)
  - High-temp capacitance probe: -14°F to 325°F (-26°C to 163°C)
  - Probe pressure rating: **50 PSI** with standard fitting; consult Dixon® for applications up to **300 PSI**
- Sensor suitable for Class I, II, III, Div 1, Groups A, B, C, and D when used with supplied controller and cable lengths of 10,000' or less
- Output relay dry contacts 2 form C (2PDT) rated 2 amps at 120/240 VAC, 1 form C (SPDT) with optional latching circuit and reset switch

### Approvals

- Cable connectors designed for repeated mating meet IP 65 mechanical and environmental specifications
- FM, CSA HAZ Loc Class I Div I, Groups B, C, and D

## A210 Spillguard Monitors

Monitor Options	24V DC Part #	120V DC Part #
A210 Spillguard monitor	A210-24	A210-120
with bypass timer	A210B-24	A210B-120
with external reset switch	A210R-24	A210R-120
dual channel control monitor	A212-24	A212-120

## ADS Spillguard® Probes

### Capacitance Probes

#### Application

- For materials with dielectric constant > 1.8: liquids, powders, slurries

#### Features

- 1/2" NPT sliding fitting standard; 3/4" fitting optional
- Open dome adapter and washout fitting available
- Tilt sensor optional

#### Materials

- Probe: 316 stainless
- Housing: NEMA 4X, IP66

#### Specifications

- Capacitance probe: **250°F (121°C)** maximum
- High temperature probe: **325°F (163°C)** maximum

Length	Capacitance	
	Capacitance	High-Temp
12"	A200PC12A	A200PHC12A
24"	A200PC24A	A200PHC24A
36"	A200PC36A	A200PHC36A
48"	A200PC48A	A200PHC48A
60"	A200PC60A	A200PHC60A
72"	A200PC72A	A200PHC72A
84"	A200PC84A	A200PHC84A



A200PC36A

C

### Multi-Point Ultrasonic Probes

#### Application

- For use when multiple detection points are required such as dribble mode, pump shutoff, and overflow alarm

#### Features

- Up to 5 sense points available
- Pressure sensor
- Ground verification
- Tilt storage probe only active in vertical operational position

NOTE: Built special order to customer specifications. Contact Dixon Bayco® at 513.874.8499 for more information.





C



### A240-Series Ground Verification Monitor

**Applications**

- Tank truck and railcar loading facilities
- Drum and barrel filling sites
- Loading of stationary tanks

**Features**

- Bright red and green indicators communicate A240 ground monitor status
- Convenient user terminal blocks make installation easy
- Environmentally sealed enclosure provides long service life even in outdoor environments
- Integrates easily into process control systems
- Provides and verifies ground bond through a single connection

**Specifications**

- Temperature rating: **-40°F to 140°F (-40°C to 60°C)**
- Ingress protection: IEC 60529 IP 66
- NEMA rating: NEMA Type 4, 4X, 7, 9
- Conduit entries: three
- Suitable for installation in hazardous locations: Class I, Division 1 & 2, Groups B, C, and D hazardous locations, Class II, Division 1 & 2, Groups E, F, and G hazardous locations, and Class III hazardous locations
- Suitable for connection to hazardous locations: Class I, Division 1 & 2, Groups A, B, C, and D hazardous locations and Class I, Zone 0, 1 & 2, Groups IIC, IIB, and IIA hazardous locations
- Ground connection threshold: relay is energized when ground clamp connection is less than 10Ω
- Number of output relays: one
- Output relay configuration: one set of FORM C contacts (normally open, common, and normally closed contacts)
- Output relay contact rating: 4Amp at 250VAC

Description	Part #
ground verification monitor 120VAC	A240120
ground verification monitor 24VDC	A240024



### A540-Series Ground Clamp and Junction Box

**Applications**

- Tank truck and railcar loading facilities
- Drum and barrel filling sites
- Loading of stationary tanks

**Features**

- Clamp is tethered to the cable by a stainless steel strap that protects the connection from strain and wear
- Pull-out resistant cord grip on junction box holds cable tighter the harder it is pulled
- Junction box creates convenient service point for hazardous location installations
- Coiled cable provides compact storage
- Strong clamping force penetrates grime and remains connected during loading process
- Provides ground and a ground-verification signal in a single clamp

**Materials**

- Jacket: thermoplastic elastomer
- Teeth: stainless steel

**Specifications**

- Temperature rating: **-40°F to 194°F (-40°C to 90°C)**
- Ingress protection: weatherproof, raintight, and dust tight
- Conduit entries: one 3/4" trade size hole and a factory-installed cable on the bottom
- Suitable for installation in hazardous locations: Class I, Division 1 & 2, Groups B, C, and D hazardous locations, Class II, Division 1 & 2, Groups E, F, and G hazardous locations and Class III hazardous locations
- Suitable for connection to hazardous locations: Class I, Division 1 & 2, Groups A, B, C, and D hazardous locations and Class I, Zone 0, 1 & 2, Groups IIC, IIB, and IIA hazardous locations
- Recommended wire between controller and the clamp: 18 GA stranded copper wire (THHN)

Description	Part #
ground clamp and junction box	A540CSB0251

### ADS Outrage Gauges

**Applications**

- Set level fill point for manual/visual fill control
- Measure outage requirements on mobile tanks

**Feature**

- Open dome bracket

**Material**

- 316 stainless steel

Length	316 Stainless Steel Standard Outrage Gauge Part #	316 Stainless Steel Outrage Gauge with J Bar Part #
2'	A800OG2	A800OGJ2
3'	A800OG3	A800OGJ3
4'	A800OG4	A800OGJ4
5'	A800OG5	A800OGJ5



### ADS Gauge Rods

**Application**

- Used to gauge liquid levels in any mobile tank

**Size**

- 1/2" x .065 weight

**Features**

- Laser engraved scale with 1/4" graduations
- Rods come in two sections that screw together at the midpoint
- Foot marks inscribed on rod at 1' intervals below the inch mark
- Heavy-duty plastic handle

**Material**

- 316 stainless steel

Description	316 Stainless Steel Part #	316 Stainless Steel Part # w/sliding innage bar
gauge rod, 4' length, one piece	ADS4GR	ADS4GR-IB
gauge rod, 8' length, two piece	ADS8GR	ADS8GR-IB
gauge rod, 12' length, two piece	ADS12GR	ADS12GR-IB



laser engraving closeup

### ADS Spillguard® Armored Cables

**Features**

- 3 or 5 pin connector
- 316 stainless steel armoured cable or yellow rubber cable
- Custom lengths available; call 513.874.8499 or 877.582.3569 for more information

#### Armored Cables

Length	3 Pin	5 Pin
15'	A200CA3P15	A200CA5P15
20'	A200CA3P20	A200CA5P20
25'	A200CA3P25	A200CA5P25
50'	A200CA3P50	A200CA5P50



#### Rubber Cable<sup>1</sup>

Length	3 Pin
25'	A200CB3P25



<sup>1</sup> For use with (-M) mini connectors only

C



A100DA



A100TTA



A200SA



A210CR-3



A210PZH-24



A210-12TC

**Accessories**

**ADS Open Dome Adapters**

**Features**

- Flexible design fits most domes
- 1/2" and 3/4" NPT port for Outalarm® probes

Stainless Steel	
Part #	
	A100DA
	A100DB

**Tank Washout Caps**

Description	Part
tank truck 3" wash-out adapter, 1/2" NPT	A100TTA
tank truck 3" wash-out adapter, 3/4" NPT	A100TTB
wash-out cap with swivel	A200SA
wash-out cap with swivel and 2" vent	A200SVA

**Cable Junction Boxes**

Description	Part
3 pin	A210CR-3
5 pin	A210CR-5

**Additional Parts & Accessories**

Description	Part
1" cam and groove coupler and 1/2" NPT bushing, stainless steel	A100CA1050
1" cam and groove coupler with 1/2" NPT busing and 1" NPT vent tee, stainless	A100CA1050V
A100 / 200 splash guard, with 1-1/8" diameter poly	A100SG-POLY
locating tab for A100 / 200 probes	A100LT
replacement A100 monitor only	A100MTR
cable to monitor adapter	A100CBLMTR
A210 Piezo horn 24VDC	A210PZH-24
tri color external signal light	A210-120TC



## Boss Coupling System ..... 152 - 163

Overview .....	152	Straight.....	170
Ground joint.....	153 - 155	Short.....	170
Complete couplings with female spud.....	153	45° Elbow .....	170
Stems .....	153	150# Flange to weld.....	171
Wing nuts.....	154	125# Flange x male NPT.....	171
Knurled nut .....	154	Port adapter.....	171
Female spuds .....	154	Elbows.....	171
Male spuds .....	155	King Crimp® Style.....	172 - 173
Double spuds.....	155	Large sleeves.....	172
Holedall® .....	155	Heavy Duty.....	173
Adapters .....	156	Combination nipples .....	173
Wing nut caps.....	156	Ferrules .....	173
Washer seal.....	157 - 158	Butterfly Valves .....	174
Complete couplings with female spud.....	157	Frac Pump Elbow Adapters.....	175
Stems .....	157	Vent-Lock® Safety Cam and Groove Couplings.....	176 - 178
Female spuds .....	157	Type A .....	176
Male spuds .....	158	Type C .....	176
Double spuds.....	158	EZ Boss-Lock Type C.....	176
Washers .....	158	Type D .....	177
Male stems.....	159 - 160	Type E.....	177
LP male stems.....	160	Dust caps.....	177
Menders.....	160	Dust plugs.....	177
Spud x Hose Shank.....	160	EZ Boss-Lock Type H dust caps.....	177
Clamps.....	161 - 162	Accessories .....	178
2 Bolt Type, 2 Gripping Fingers.....	161	Handles .....	178
4 Bolt Type, 2 Gripping Fingers.....	161		
4 Bolt Type, 4 Gripping Fingers.....	162		
6 Bolt Type, 3 Gripping Fingers.....	162		
6 Bolt Type, 6 Gripping Fingers.....	162		
Ground joint air hammer couplings .....	163		

## Boss Low Pressure System (LPS).... 164 - 178

Components overview .....	164
Frac fittings .....	165 - 166
Complete Male / Female Assembly .....	165
Female .....	165
Male with nut.....	166
Suction service fittings .....	166
O-rings.....	166
Short ferrules.....	166
Hammer Union .....	167 - 169
Nuts.....	167
One-Piece .....	167
Two-Piece.....	167
Three-Piece .....	167
100-Series.....	168
200-Series.....	168
206-Series .....	168
Caps and plugs.....	169
One-Piece adapters.....	170 - 171
Flange .....	170 - 171

## Boss Coupling System

### Features

- The spud part of the coupling serves as one half of the connection and is usually fixed to the equipment. The stem part that is clamped to the hose is the other half. The two halves are connected or disconnected by rotating the wing nut onto the spud. When connected they achieve both a mechanical and a pressure seal.

### Services

- Boss couplings are all-purpose hose couplings, universally recommended for steam hose connections. They are also widely used for air, water, fluid petroleum, chemicals, and liquid petroleum gas up to 1" I.D.. Boss couplings can be applied to many types of rubber, synthetic, plastic, metallic, or semi-metallic hose. Consult Dixon® for specific media capabilities.

### Purpose

Boss couplings supply a convenient threaded fitting to connect two lengths of hose, or a single length to a male or female threaded (NPT) outlet.

### Materials

- Stem: 1/4" - 1" plated steel, 1-1/4" - 4" plated iron, 6" tubular steel
- Spud: 1/4" - 1" plated steel, 1-1/4" - 6" plated iron
- Wing nut: 1/4" plated steel, 3/8" - 6" plated iron

### Seal Types

- Ground joint: copper or polymer seats
- Washer: Klingersil® C-4401

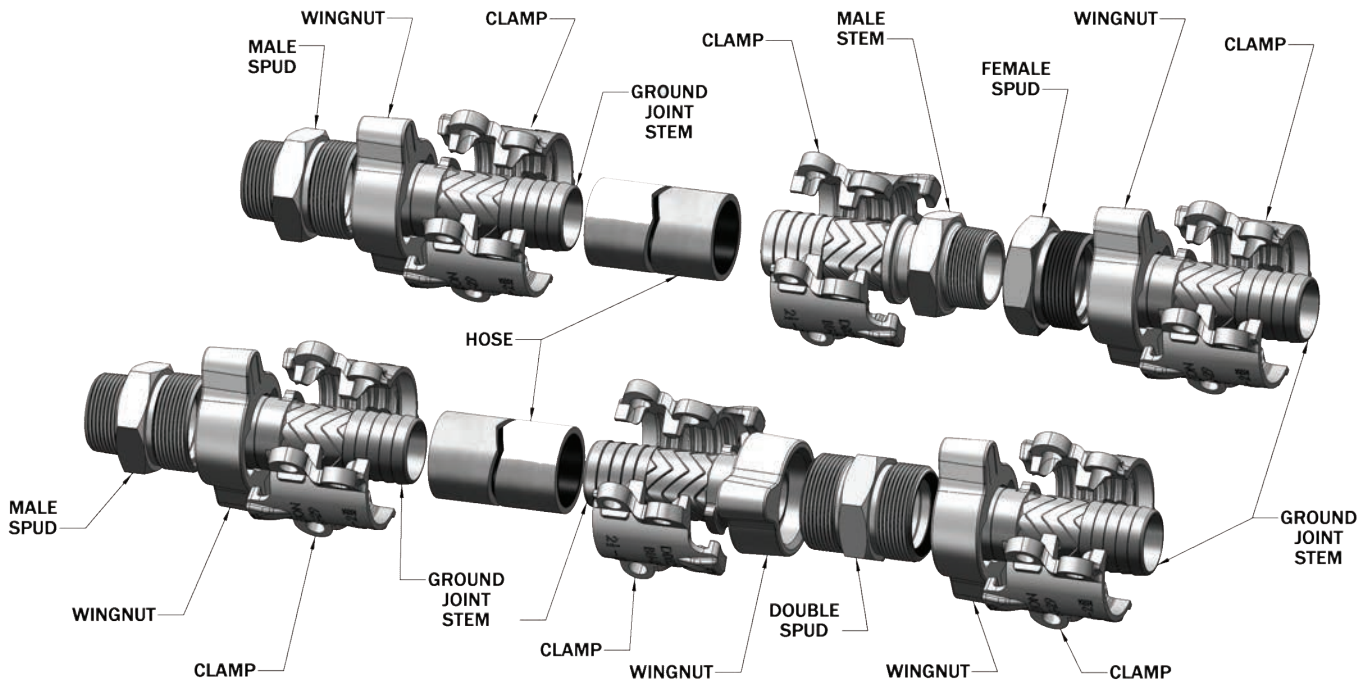

Worn-out hose couplings can be dangerous. They should be checked regularly and replaced when necessary. Each coupling user should review applications and add safety devices where indicated.



**Features**

- Positive metal-to-polymer seal
- Leakproof seal forms when the metal head of the stem makes contact with the patented polymer seat in the spud
- Non-metallic polymer seat resists most chemicals found in manufacturing facilities (reference corrosion resistance chart on pages 1109 - 1114)
- Easy to seal
- Use with Boss clamps found on pages 161 - 162

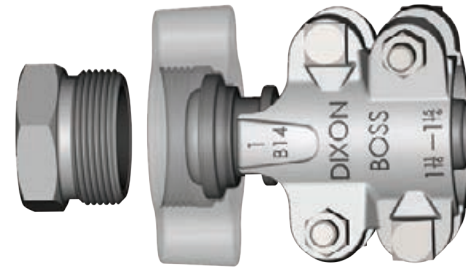

**Specification**

- Recommended for steam service up to 450°F (232°C)

**Boss Ground Joint Couplings with Female Spud**

Hose Shank x NPT	Plated Steel and / or Iron Part #	316 Stainless Steel Part #	Brass Part #
1/4"	GF1 <sup>1</sup>	---	---
3/8"	GF3 <sup>1</sup>	---	---
1/2"	GF6	---	---
1/2" x 3/4"	GF26-1	---	---
3/4"	GF26	RGF26	BGF26
1"	GF36	RGF36	BGF36
1-1/4"	GF51	RGF51	---
1-1/2"	GF61	RGF61	---
2"	GF81 <sup>2</sup>	RGF81 <sup>2</sup>	---
2-1/2"	GF96	---	---
3"	GF111	---	---
4"	GF141	---	---
6"	GF201 <sup>1</sup>	---	---

<sup>1</sup> 1/4", 3/8", and 6" available only with copper seat spuds

<sup>2</sup> Not to be used with #250, #275, or #306 Boss clamps



**Boss Ground Joint Stems**

Hose Shank x NPT	Plated Steel and / or Iron Part #	Optional Qty	316 Stainless Steel Part #	Brass Part #
1/4"	GBA	100	---	---
3/8"	GCA	100	---	---
1/2"	GB1	100	---	---
1/2" x 3/4"	GB6-1	50	---	---
3/4"	GB6	50	RGB6	BGB6
1"	GB11	50	RGB11	BGB11
1-1/4"	GB16	25	RGB16	---
1-1/2"	GB21	25	RGB21	---
2"	GB26 <sup>2</sup>	10	RGB26 <sup>1</sup>	---
2-1/2"	GB31	5	---	---
3"	GB36 <sup>2</sup>	5	---	---
4"	GB46	5	---	---
6"	GB66	2	---	---

<sup>1</sup> Not to be used with #250, #275, or #306 Boss clamps

<sup>2</sup> GB26 / GB36 have machined shank to accept Boss clamps, King Crimp® sleeves, ferrules. Use only Boss clamps on GB26 / GB36 for steam service.

Only use the crimp style shanks with the crimp style sleeves and ferrules.

Due to differences in dimensions and tolerances for safety reasons, do not interchange other manufacturers' products with Dixon® products. Pressure rating is based on the seal of the mating part. Reference [dixonvalve.com](http://dixonvalve.com) for a complete list of ratings.

The King Crimp sleeve and ferrule are not intended for steam service.



### Boss Wing Nuts



Plated iron / steel



316 stainless steel



Brass

Size	Plated Steel and / or Iron Part #	Optional Qty	316 Stainless Steel Part #	Brass Part #
1/4"	SLS4	100	---	---
3/8"	CB	100	---	---
1/2"	B2	100	---	---
3/4"	B12	25	RB12	BB12
1"	B12	25	RB12	BB12
1-1/4"	B17	25	RB17	---
1-1/2"	B17	25	RB17	---
2"	B27	10	RB27	---
2-1/2"	B32	5	---	---
3"	B37	5	---	---
4"	B47	5	---	---
6"	B67	2	---	---

### Boss Knurled Nut



Size	Plated Steel Part #	Optional Qty
3/4" and 1"	KB12	25

### Boss Ground Joint Female Spuds

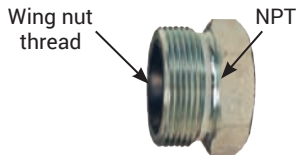

Size	Plated Steel and / or Iron Part #	Optional Qty	316 Stainless Steel Part #	Brass Part #
1/4"	GBC <sup>1</sup>	100	---	---
3/8"	GCC <sup>1</sup>	100	---	---
1/2"	GB3	100	---	---
3/4"	GB8	50	RGB8	BGB8
1"	GB13	50	RGB13	BGB13
1-1/4"	GB18	25	RGB18	---
1-1/2"	GB23	25	RGB23	---
2"	GB28	10	RGB28	---
2-1/2"	GB33	5	---	---
3"	GB38	5	---	---
4"	GB48	5	---	---
6"	GB68 <sup>1</sup>	2	---	---

<sup>1</sup> 1/4", 3/8", and 6" available only with copper seat spuds; all other sizes have polymer seats

## Boss Ground Joint Male Spuds

Size	Plated Steel Part #	Plated Iron Part #
3/8	GMC <sup>1</sup>	---
1/2"	GM3	---
3/4"	GM8	---
1"	GM13	---
1-1/4"	---	GM18
1-1/2"	---	GM23
2"	---	GM28
2-1/2"	---	GM33
3"	---	GM38

<sup>1</sup> 1/4", 3/8", and 6" available only with copper seat spuds, all other sizes have polymer seats



D

## Boss Ground Joint Double Spuds

Size	Plated Steel Part #	Plated Iron Part #
1/2"	GDB3	---
3/4" and 1"	GDB13	---
1-1/4" and 1-1/2"	---	GDB23
2"	---	GDB28
2-1/2"	---	GDB33
3"	---	GDB38

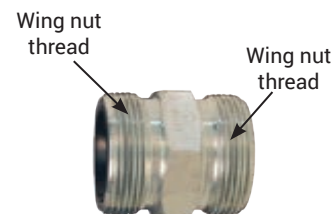

## Boss Holedall® Fittings

### Applications

- Designed for air and liquid applications where a permanent, low-profile clamping system is desired
- Not for steam service 

### Features

- Supplied with carbon steel ferrules
- Consult Dixon® for swage and/or crimp specifications

Size	Hose O.D.		Plated Iron / Steel Part #	Plated Iron / Steel Part # <sup>2</sup>	Stainless Steel Part #
	From	To			
3/4"	1-10/64"	1-14/64"	GF26P1	GB6-P1	---
	1-15/64"	1-18/64"	GF26P2	GB6-P2	---
	1-19/64"	1-22/64"	GF26P3	GB6-P3	---
1"	1-30/64"	1-34/64"	GF36P1	GB11-P1	---
	1-35/64"	1-38/64"	GF36P2	GB11-P2	---
	1-39/64"	1-42/64"	GF36P3	GB11-P3	---
1-1/2"	1-58/64"	2"	GF61P1	GB21-P1	RGF61P1
	2-1/64"	2-8/64"	GF61P2	GB21-P2	RGF61P2
	2-9/64"	2-16/64"	GF61P3	GB21-P3	---
2"	2-28/64"	2-40/64"	GF81P1 <sup>1</sup>	GB26-P1	RGF81P1
	2-41/64"	2-48/64"	GF81P2 <sup>1</sup>	GB26-P2	RGF81P2
	2-49/64"	2-56/64"	GF81P3 <sup>1</sup>	GB26-P3	---
3"	3-30/64"	3-40/64"	GF111P1 <sup>1</sup>	GB36-P1	---
	3-41/64"	3-48/64"	GF111P2 <sup>1</sup>	GB36-P2	---
	3-49/64"	3-56/64"	GF111P3 <sup>1</sup>	GB36-P3	---



GF61P1



GB21-P1

<sup>1</sup> 2" and 3" have a machined shank

<sup>2</sup> Without spuds

## Boss Adapters

### Female NPT

#### Features

- Designed to fit the standard ground joint spuds on pages 154 - 155
- Supplied with a wing nut, as shown
- For safety tags and safety tape, see page 1065



Size	Plated Steel and / or Iron Part #	316 Stainless Steel Part #
3/4"	GFAS6	RGFAS6
1"	GFAS11	RGFAS11
1-1/4"	GFAS16	---
1-1/2"	GFAS21 <sup>1</sup>	---
2"	GFAS26	---
3"	GFAS36	---

<sup>1</sup> Part is produced as a welded fabrication

### Male NPT



Size	Plated Steel and / or Iron Part #	316 Stainless Steel Part #
3/4"	GMAS6	RGMAS6
1"	GMAS11	---
1-1/4"	GMAS16	---
1-1/2"	GMAS21	---
2"	GMAS26 <sup>1</sup>	---
3"	GMAS36	---

<sup>1</sup> Uses a special wing nut, part # B27-1

## Boss Wing Nut Caps

#### Features

- Supplied with 12" chain and washer
- For best results, use with washer style spuds and washers on page 158
- Not intended for pressure applications 



Size	Plated Steel and / or Iron Part #	316 Stainless Steel Part #	Opt Qty
1/2"	B2SC	---	10
3/4" and 1"	B12SC	RB12SC	25
1-1/4" and 1-1/2"	B17SC	---	25
2"	B27SC	---	10
3"	B37SC	---	5

### Features

- Easy to seal
- Klingersil® C-4401 washer is inserted between the stem and spud
- Leakproof seal forms by rotating the wing nut and hammering it tight
- Use with Boss clamps found on pages 161 - 162
- Use with wing nuts found on page 154

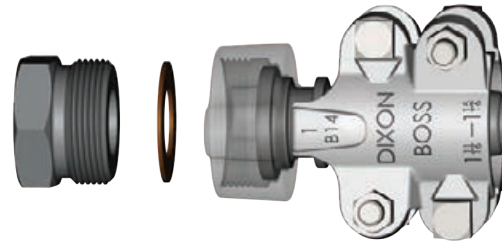

### Specifications

- Recommended for steam service up to 450°F (232°C)

## Boss Washer Seal Couplings with Female Spud

Hose Shank x NPT	Plated Steel and / or Iron Part #	316 Stainless Steel Part #
3/8"	WF3	---
1/2"	WF6	---
1/2" x 3/4"	WF26-1	---
3/4"	WF26	RWF26
1"	WF36	RWF36
1-1/4"	WF51	RWF51
1-1/2"	WF61	RWF61
2"	WF81 <sup>1</sup>	RWF81 <sup>1</sup>
2-1/2"	WF96	---
3"	WF111	---

<sup>1</sup> Not to be used with #250, #275, or #306 Boss clamps



## Boss Washer Seal Stems

Hose Shank x NPT	Plated Steel and / or Iron Part #	Opt Qty	316 Stainless Steel Part #
3/8"	SS337	100	---
1/2"	B1	100	---
1/2" x 3/4"	B6-1	50	---
3/4"	B6	50	RB6
1"	B11	50	RB11
1-1/4"	B16	25	RB16
1-1/2"	B21	25	RB21
2"	B26 <sup>1</sup>	10	RB26 <sup>1</sup>
2-1/2"	B31	5	---
3"	B36	5	---

<sup>1</sup> Not to be used with #250, #275, or #306 Boss clamps



## Boss Washer Seal Female Spuds

Thread Size	Plated Steel and / or Iron Part #	Opt Qty	316 Stainless Steel Part #
3/8"	CC	100	---
1/2"	B3	100	---
3/4"	B8	25	RB8
1"	B13	50	RB13
1-1/4"	B18	25	RB18
1-1/2"	B23	25	RB23
2"	B28	10	RB28
2-1/2"	B33	5	---
3"	B38	5	---

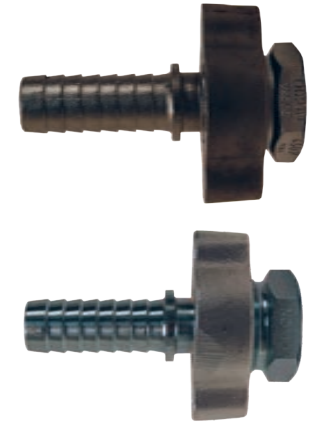

### Boss Washer Seal Male Spuds

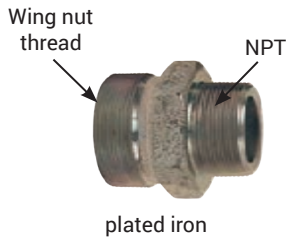

Thread	Plated Steel Part #	Plated Iron Part #
3/8"	WMC	---
1/2"	WM3	---
3/4"	WM8	---
1"	WM13	---
1-1/4"	---	WM18
1-1/2"	---	WM23
2"	---	WM28
3"	---	WM38

### Boss Washer Seal Double Spuds

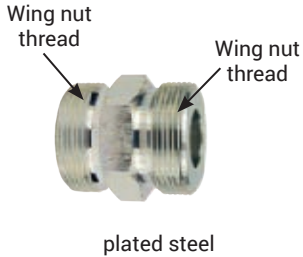

Thread	Plated Steel Part #	Plated Iron Part #
3/8"	---	---
1/2"	DB3	---
3/4"	DB13	---
1"	DB13	---
1-1/4"	---	DB23
1-1/2"	---	DB23
2"	---	DB28
3"	---	DB38

### Boss Washer Seal Washers



Size	Nitrile Rubber Bonded, Non-Asbestos Klingersil® C-4401 Part #
3/8"	WBC
1/2"	W2
3/4"	W12
1"	W12
1-1/4"	W17
1-1/2"	W17
2"	W27
2-1/2"	W32
3"	W37



## Boss Male Stems

### Feature

- Use with Boss clamps on pages 161 - 162 for safety tags and safety tape see page 1065

### Specification

- Recommended for steam service up to 450°F (232°C)

Hose x NPT size	Plated Steel Bar Stock Part #	Opt Qty	Size	Plated Iron Part #	Opt Qty
1/4" x 1/8"	MS4X2	100	---	---	---
1/4" x 1/4"	MSA	100	---	---	---
1/4" x 3/8"	MSB	25	---	---	---
3/8" x 1/4"	MS6X4	100	1-1/4"	MS16	20
3/8" x 3/8"	MSC	100	1-1/2"	MS21	20
3/8" x 1/2"	MS6X8	50	2"	MS26	10
1/2" x 1/4"	MS8X4	50	2-1/2"	MS31	5
1/2" x 3/8"	MS8X6	50	3"	MS36	5
1/2" x 1/2"	MS1	50	4"	MS46	2
1/2" x 3/4"	MS8X12	25	---	---	---
3/4" x 1/2"	MS12X8	25	---	---	---
3/4" x 3/4"	MS6	50	---	---	---
3/4" x 1"	MS12X16	25	---	---	---
1" x 3/4"	MS16X12	25	---	---	---
1" x 1"	MS11	25	---	---	---

Size	316 Stainless Part #	Size	Brass Part #
1/2"	RMS1	---	---
3/4"	RMS6	3/4"	BMS6
1"	RMS11	1"	BMS11
1-1/4"	RMS16	1-1/4"	BMS16
1-1/2"	RMS21	1-1/2"	BMS21
2"	RMS26	2"	BMS26
2-1/2"	RMS31	---	---
3"	---	3"	---



plated steel



plated iron



316 stainless



brass

D

## LP Boss Male Stems - Male NPT End



Size	Schedule 40 Plated Steel Part #	Schedule 40 Stainless Steel Part #	Schedule 80 Plated Steel Part #
1-1/4"	LP16	---	LP16-80 <sup>1</sup>
1-1/2"	LP21	---	LP21-80 <sup>1</sup>
2"	LP26	---	LP26-80 <sup>1</sup>
2-1/2"	LP31	---	---
3"	LP36	RLP36	---
4"	LP46	RLP46	---
6"	LP66	---	---

<sup>1</sup> Schedule 80 stems meet NFPA 58

## LP Boss Male Stems - Beveled End



Size	Schedule 40 Unplated Steel Part #
2"	LPB26
3"	LPB36

## Boss Hose Menders

### Features

- Collars designed to engage gripping fingers of Boss clamps
- 3/4" - 3" plated iron; 1/2" plated steel



Size	Part #
1/2"	M1
3/4"	M6
1"	M11
1-1/4"	M16
1-1/2"	M21
2"	M26
2-1/2"	M31
3"	M36

## Boss Spud x Hose Shank

### Material

- Seat: polymer



Thread	Steel Part #
1"	GH1311
2"	GH2826

## Boss Clamps

### ⚠ WARNING

- The bolts used in the Boss interlocking clamps are not standard bolts. They vary from standard bolts in their length, diameter, overall thread length, and material hardness. These bolts can be retorqued, but it is not recommended that the bolts or clamps be reused, as they are designed for a single bend only. Dixon® recommends using only factory-supplied replacement bolts.
- Torque values for clamps are based on dry bolts. The use of lubricant on bolts will adversely effect clamp performance. Do not lubricate nuts and bolts.
- For all bolt tightening sequences, please visit [dixonvalve.com](http://dixonvalve.com)

#### Feature

- Replacement nuts and bolts are available; contact Dixon for more information

#### Specifications

- Recommended for steam service up to 450°F (232°C)
- Recommended torque rating in ft. lbs.

#### 2-Bolt Type, 2-Gripping Fingers

Hose I.D.	Hose O.D.		Zinc Plated Iron Part #	Pkg Qty	Stainless Steel <sup>4</sup> Part #	Torque ft. lbs. <sup>2</sup>	Brass Part #	Torque ft. lbs.
	from	to						
1/4"	36/64"	42/64"	BD <sup>3</sup>	100	---	6	---	---
3/8"	44/64"	56/64"	CD <sup>3</sup>	100	---	6	---	---
	52/64"	60/64"	DD <sup>3</sup>	100	---	6	---	---
1/2"	60/64"	1-4/64"	B4 <sup>3</sup>	25	RB4	12	BB4	10
	1-4/64"	1-12/64"	B5	25	---	12	---	---
3/4"	1-10/64"	1-20/64"	BU9 <sup>3</sup>	50	RBU9	21	BBU9	18
	1-20/64"	1-32/64"	B9	25	RB9	21	---	---
	1-32/64"	1-44/64"	B10 <sup>3</sup>	25	---	21	---	---



#### 4-Bolt Type, 2-Gripping Fingers

Hose I.D.	Hose O.D.		Zinc Plated Iron Part #	Pkg Qty	Stainless Steel <sup>4</sup> Part #	Torque ft. lbs. <sup>2</sup>	Brass Part #	Torque ft. lbs.
	from	to						
1"	1-34/64"	1-46/64"	BU14	25	RBU14	21	BBU14	18
	1-44/64"	1-60/64"	B14	25	RB14	21	---	---
	1-60/64"	2-8/64"	B15	20	---	21	---	---
1-1/4"	1-32/64"	1-50/64"	BU18	20	---	40	---	---
	1-50/64"	2-6/64"	BU19	10	---	40	---	---
	2-8/64"	2-24/64"	B19	10	RB19	40	---	---
1-1/2"	1-52/64"	2"	BU22	10	---	40	---	---
	2"	2-14/64"	B22	10	---	40	---	---
	2-12/64"	2-24/64"	BU24	10	RBU24	40	---	---
2"	2-24/64"	2-36/64"	B24	10	RB24	40	---	---
	2-36/64"	2-48/64"	B25	10	---	40	---	---
	2-22/64"	2-34/64"	BU28	9	---	60	---	---
	2-32/64"	2-50/64"	BU29	10	RBU29	60	BBU29 <sup>1</sup>	40
	2-48/64"	3-4/64"	B29	10	RB29	60	---	---
2-1/2"	3-6/64"	3-28/64"	B30	5	---	60	---	---
	3-6/64"	3-28/64"	BU34	5	---	60	---	---
	3-32/64"	3-60/64"	B34	5	---	150	---	---
3"	3-32/64"	3-60/64"	BU35	5	RBU35	150	---	---
	3-52/64"	4-4/64"	B35	5	---	150	---	---
	4-4/64"	4-28/64"	B39	5	---	200	---	---



<sup>1</sup> Will become obsolete as inventory is depleted

<sup>2</sup> Torque applies to plated iron and stainless steel clamps

<sup>3</sup> Global investment cast carbon steel

<sup>4</sup> When installing stainless steel bolts and nuts, the use of anti-seize or anti-galling lubricant is advised. A light coat is required on the bolt threads to prevent thread galling and artificial torque reading.

## Boss Clamps

### ⚠ WARNING

- The bolts used in the Boss interlocking clamps are not standard bolts. They vary from standard bolts in their length, diameter, overall thread length, and material hardness. These bolts can be retorqued, but it is **not** recommended that the bolts or clamps be reused, as they are designed for a single bend only. Dixon® recommends using only factory supplied replacement bolts.
- Torque values for clamps are based on dry bolts. The use of lubricant on bolts will adversely effect clamp performance. *Do not lubricate nuts and bolts.*
- For all bolt tightening sequences, please visit [dixonvalve.com](http://dixonvalve.com)

#### Feature

- Replacement nuts and bolts are available; contact Dixon for more information

#### Specifications

- Recommended for steam service up to **450°F (232°C)**
- Recommended torque rating in ft. lbs.

#### 4-Bolt Type, 4-Gripping Fingers

Hose I.D.	Hose O.D.		Zinc Plated Iron Part #	Optional Qty	Torque ft. lbs.
	from	to			
1/2"	58/64"	1-2/64"	968	50	6
1"	1-26/64"	1-36/64"	156	20	21
1-1/4"	1-44/64"	1-56/64"	187	10	21
	1-56/64"	2-4/64"	206	20	21
1-1/2"	2"	2-8/64"	212	10	21
	2-4/64"	2-16/64"	225	10	40
2"	2-16/64"	2-32/64"	250 <sup>1</sup>	10	40
	2-32/64"	2-48/64"	275 <sup>1</sup>	10	40
	2-48/64"	3-4/64"	306 <sup>1</sup>	5	60
2-1/2"	3-4/64"	3-32/64"	350	5	60
	3-32/64"	3-48/64"	375	5	60
3"	3-48/64"	4"	401	5	150
	4"	4-12/64"	418	2	200
	4-12/64"	4-32/64"	450	2	200

<sup>1</sup> Not to be used with GF81, GB26, WF81, B26, RGF81, RGB26, BGF81, RWF81, RB26



#### 6-Bolt Type, 3-Gripping Fingers

Hose I.D.	Hose O.D.		Zinc Plated Iron Part #	Optional Qty	Torque ft. lbs.
	from	to			
3"	4-16/64"	4-52/64"	BS39	2	150
	4-40/64"	5"	B45	3	150
4"	4-56/64"	5-16/64"	BS49	2	200
	5-16/64"	5-38/64"	BU49	2	200
	5-34/64"	5-60/64"	B49	2	200

#### 6 Bolt Type, 6 Gripping Fingers

Hose I.D.	Hose O.D.		Zinc Plated Iron Part #	Optional Qty	Torque ft. lbs.
	from	to			
6"	6-56/64"	7-24/64"	750	1	200
	7-32/64"	8"	850	1	200



## Ground Joint Air Hammer Couplings with Female Spud

### Female Spuds

#### Features

- Rounded steel head of stem fits concave inserts in spuds for superior sealing
- Metal-to-metal copper seat seal
- For use with Boss clamps on pages 161 - 162

Style	NPT Size	Plated Steel / Iron Part #
Compact	1/2"	GDF6
	3/4"	GDF8
Heavy duty	3/4"	GDF10
	1"	GDF12



D

### Stems

Style	Hose I.D.	Plated Steel Part #
Compact	1/2"	GBA45
	3/4"	GBA46
Heavy duty	3/4"	GBB18
	1"	GBB11



### Wing Nuts

Style	Hose I.D. and NPT Sizes	Coarse Nut Thread	Iron Part #
Compact	1/2"	1-31/64" O.D. x 8 TPI	J47
	3/4"		J47
Heavy duty	3/4"	1-47/64" O.D. x 8 TPI	DLB12
	1"		DLB12



### Female Spuds

Style	NPT Size	Coarse Nut Thread	Plated Steel w/ Copper seat Part #
Compact	1/2"	1-31/64" O.D. x 8 TPI	GJ65
	3/4"		GJ55
Heavy duty	3/4"	1-47/64" O.D. x 8 TPI	GDL8
	1"		GDL13



### Male Spuds

Style	Hose I.D. and NPT Sizes	Coarse Nut Thread	Plated Steel w/ Copper seat Part #
Compact	1/2"	1-31/64" O.D. x 8 TPI	GJ60
	3/4"		GJ50
Heavy duty	3/4"	1-47/64" O.D. x 8 TPI	GDL7
	1"		GDL10



### Double Spuds

Style	Hose I.D. and NPT Sizes	Coarse Nut Thread	Plated Steel w/ Copper seat Part #
Compact	1/2"	1-31/64" O.D. x 8 TPI	GJ75
	3/4"		GJ75
Heavy duty	3/4"	1-47/64" O.D. x 8 TPI	GDL25
	1"		GDL25



## Boss Low Pressure System (LPS) Components

Dixon® is committed to improving end user productivity and reducing environmental and safety related incidents on the low pressure side of hydraulic fracturing sites. Boss Low Pressure System products are built around the premise: "no welds, no threads, no leaks." The product line is continually expanding. Visit [dixonvalve.com/bosslps](http://dixonvalve.com/bosslps) for the latest updates.

D

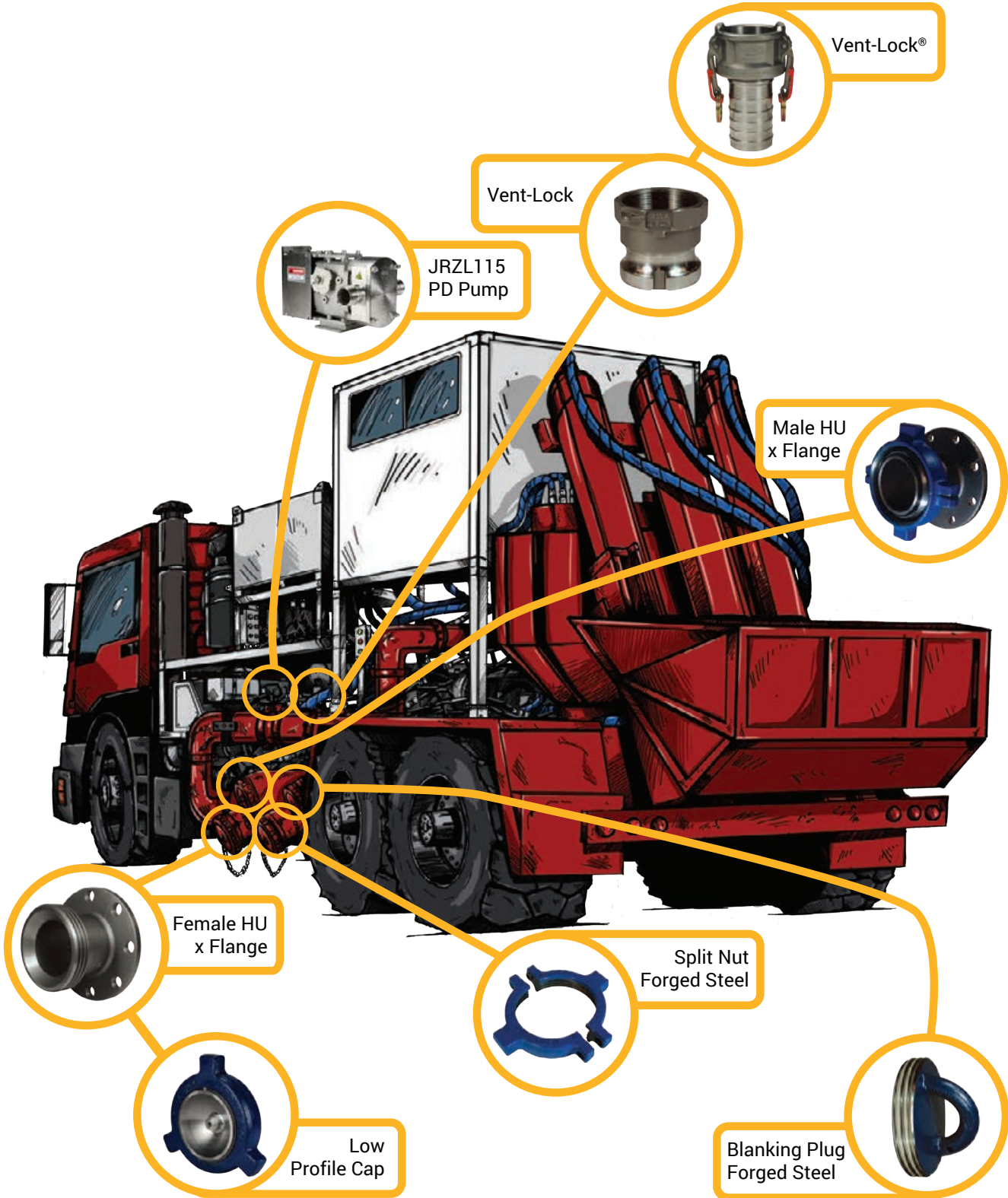

## Dixon® Boss LPS Frac Fittings

### Application

- Used in the fast-paced transfer of water, chemicals, and sand slurry to a hydraulic fracturing site

### Features

- One-piece stem design eliminates the leak path common with two-piece threaded systems
- Interchangeable with current fittings; phase them into your operation
- Designed to work with Dixon King Crimp® sleeves or ferrules 

### Materials

- Fittings: machined iron to ASTM standards; all stems zinc plated
- Male 3", 4", and 6" NPT fittings are schedule 80 pipe; 8" NPT fittings are schedule 40 pipe; all sizes meet ASTM standards
- Nut: forged steel meeting AISI standards

### Specifications

- 400 PSI** working pressure at **70°F (21°C)** for 3" and 4" sizes; 4:1 safety factor (SF)<sup>1</sup>
- 230 PSI** working pressure at **70°F (21°C)** for 6" size; 4:1 safety factor (SF)
- 150 PSI** working pressure at **70°F (21°C)** for 8" size; 3:1 safety factor (SF)

<sup>1</sup> **400 PSI** working pressure with a minimum 4:1 safety factor (*hose burst: hose working pressure*) is only achieved with:

- 3" size uses standard crimp ferrules
- 4" size requires heavy duty (HD) crimp ferrules, CF400-6CSHD through CF400-16CSHD and heavy duty stems

NOTE: Water and petroleum transfer hoses rated from **100 to 300 PSI** WP (4:1 SF) have excellent test results with the standard King Crimp ferrules CF400-xxCS.

### Complete Male / Female Assembly

Size	Figure	Part #
2"	200	HUMF200200CS
	206	HUMF206200CS
3"	100	HUMF100300CS
	200	HUMF200300CS
	206	HUMF206300CS
4"	100	HUMF100400CS
	200	HUMF200400CS
	206	HUMF206400CS
6"	100	HUMF100600CS
	200	HUMF200600CS
	206	HUMF206600CS
8"	100	HUMF100800CS
	200	HUMF200800CS
	206	HUMF206800CS



### Female

Size	Figure	Part #
2"	206	HUF206200CS
3"	100	HUF100300CS
	206	HUF206300CS
4"	100	HUF100400CS
	206	HUF206400CS
6"	100	HUFALL600CS <sup>1</sup>
	206	
8"	100	HUFALL800CS <sup>1</sup>
	206	



<sup>1</sup> Meets both figure 100 and 206 dimensional specifications

## Dixon® Boss LPS Frac Fittings

### Male with Nut



3" and 4"



6" and 8"

Size	Figure	Part #
2"	200	HUM200200CS <sup>1</sup>
	206	HUM206200CS <sup>2</sup>
3"	100	HUM100300CS <sup>1</sup>
	200	HUM200300CS <sup>1</sup>
	206	HUM206300CS <sup>2</sup>
4"	100	HUM100400CS <sup>1</sup>
	200	HUM200400CS <sup>1</sup>
	206	HUM206400CS <sup>2</sup>
6"	100	HUM100600CS <sup>1</sup>
	200	HUM200600CS <sup>1</sup>
	206	HUM206600CS <sup>2</sup>
8"	100	HUM100800CS <sup>1</sup>
	200	HUM200800CS <sup>1</sup>
	206	HUM206800CS <sup>2</sup>

<sup>1</sup> Includes nut

<sup>2</sup> Includes nut and O-ring

### Suction Service Fittings



HUSM500SW-1



HUSF500SW

Size	Figure	Description	Forged Steel Part #
5"	50	socket weld x suction male hammer union (includes O-ring, no nut)	HUSM500SW-1
		socket weld x suction female hammer union	HUSF500SW
5"	N/A	split nut, suction and discharge, black	HUS500RN

### Dixon Frac Fitting O-rings

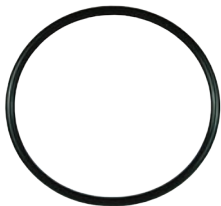

Size	Figure	Nitrile Rubber Part #
3"	206	O238BU
4"	206	O347BU
6"	206	O440BU
8"	206	O447BU

### King Crimp® Style Short Frac Ferrules

#### Features

- Schedule 40 plated carbon steel to ASTM standards
- Consult Dixon for additional ferrule sizes



Hose I.D.	Hose O.D.		Ferrule Wall Thickness	Ferrule I.D.	Ferrule Overall Length	Carbon Steel Part #
	From	To				
8"	8-29/64"	8-36/64"	.120"	8.625"	4.25"	CFS800-1CS
	8-37/64"	8-44/64"	.120"	8.750"	4.25"	CFS800-2CS
	8-45/64"	8-52/64"	.120"	8.875"	4.25"	CFS800-3CS
	8-53/64"	8-60/64"	.120"	9.000"	4.25"	CFS800-4CS
	8-61/64"	9-4/64"	.120"	9.125"	4.25"	CFS800-5CS
	9-5/64"	9-12/64"	.120"	9.250"	4.25"	CFS800-6CS
	9-13/64"	9-20/64"	.120"	9.375"	4.25"	CFS800-7CS
	9-21/64"	9-28/64"	.120"	9.500"	4.25"	CFS800-8CS



## Dixon® Boss LPS Hammer Union Nuts

### One-Piece

#### Features

- Long-lasting and dependable nut
- All nuts are interchangeable with reliable brands
- 6" and 8" sizes have 4-lug design for more surface area to hammer

#### Specification

- Cold working pressure: Figure 100 **1,000 PSI**, Figure 200/206 **2,000 PSI**

Size	Figure	Forged Steel AISI Standards Part #
1"	200/206	HU206100N
2"	200/206	HU206200N
3"	100	HU100300N
	200/206	HU206300N
4"	100	HU100400N
	200/206	HU206400N
6"	100	HU100600N
	200/206	HU206600N
8"	100	HU100800N
	200/206	HU206800N



3" and 4"



6" and 8"

D

### Two-Piece

#### Applications

- Replacement for damaged hammer union nuts
- Used with male one-piece flange adapters

#### Features

- Lug design provides enlarged surface area to hammer
- Repair nut is pinned and bolted for perfect alignment
- Nut can be installed on pre-existing hammer union assembly
- 4" Figure 200/206 nut is interchangeable with reliable brands
- 6" and 8" Figure 100/200/206 nuts are interchangeable with reliable brands
- Available in other series and sizes; contact Dixon

#### Specification

- Cold working pressure: Figure 50 **500 PSI**, Figure 100 **1,000 PSI**, Figure 200/206 **2,000 PSI**

Dixon recommends using Loctite® Threadlocker Red 271™ when bolting together two-piece hammer union nuts to ensure that bolts do not loosen when in service. Option two is to weld the seams of the split nut. Bolt torque recommendation is 60 ft. lbs.



figure 200 / 206



figure 100

Size	Figure	Forged Steel AISI Standards Part #
4"	split nut, figure 200/206, blue (includes bolts)	HU200400RN
5"	figure 50, black	HUS500N
	split nut, figure 50, black (includes bolts)	HUS500RN
6"	split nut, figure 100, black (includes bolts)	HU100600RN
	split nut, figure 200/206, blue (includes bolts)	HU200600RN
8"	split nut, figure 100, black (includes bolts)	HU100800RN
	split nut, figure 200/206, blue (includes bolts)	HU200800RN

### Three-Piece

#### Features

- Replacement for damaged hammer union nuts
- Used with male one-piece flange adapters
- Can use tools/wrench made for loosening and tightening nuts

#### Specification

- Cold working pressure: Figure 200/206 **2,000 PSI**

Size	Figure	Forged Steel AISI Standards Part #
4"	split nut, figure 200/206, blue (includes bolts)	HU200400RN3



figure 200 / 206

## Dixon® Boss LPS Hammer Unions

### Features

- Socket weld configurations and other materials are available; contact Dixon for further information
- Hammer unions work at extremely high pressures, mismatching components of one series with another (i.e. series 602 with series 1502) can lead to destruction of property, serious bodily injury, or death
- Non-shocking cold water pressure means that the rated value is the maximum operating pressure at ambient temperature
- No spikes higher than this pressure
- No instantaneous pressure increases (0-2,000 PSIG in 1/4 of a second)



### Specifications

- Temperature range: -20°F to 250°F (-29°C to 121°C)
- Ambient temperature: 70°F (21°C)



### 100-Series

#### Feature

- Yellow sub, black nut

#### Specification

- Used on low pressure manifolds and lines and in applications running air, water, oil, or gas up to **1,000 PSI NSCW** (non-shock cold working pressure)

Size	Configuration	NSCWP (PSI)	Forged Steel Part #
2"	threaded	1,000	HU100200
	butt weld	1,000	HU100200BW <sup>1</sup>
2-1/2"	threaded	1,000	HU100250
3"	threaded	1,000	HU100300
4"	threaded	1,000	HU100400
	butt weld	1,000	HU100400BW <sup>1</sup>
6"	threaded	1,000	HU100600
8"	threaded	1,000	HU100800

<sup>1</sup> Butt weld ends are schedule 40

### 200-Series

#### Features

- Nitrile O-ring mounted sub provides excellent sealing properties
- Grey sub, blue nut

#### Specification

- Used in general service applications running air, water, oil, or gas up to **2,000 PSI NSCW** (non-shock cold working pressure)



Size	Configuration	NSCWP (PSI)	Forged Steel Part #
1"	threaded	2,000	HU200100
1-1/2"	threaded	2,000	HU200150
2"	threaded	2,000	HU200200
	butt weld	2,000	HU200200BW <sup>1</sup>
2-1/2"	threaded	2,000	HU200250
3"	threaded	2,000	HU200300
4"	threaded	2,000	HU200400
6"	threaded	2,000	HU200600
8"	threaded	2,000	HU200800

<sup>1</sup> Butt weld ends are schedule 40

### 206-Series

#### Features

- Nitrile O-ring mounted sub provides excellent sealing properties
- Grey sub, blue nut

#### Specification

- Used in general service applications running air, water, oil and gas up to **2,000 PSI NSCW** (non-shock cold working pressure)



Size	Configuration	NSCWP (PSI)	Forged Steel Part #
1"	threaded	2,000	HU206100
1-1/2"	threaded	2,000	HU206150
2"	threaded	2,000	HU206200
2-1/2"	threaded	2,000	HU206250
3"	threaded	2,000	HU206300
4"	threaded	2,000	HU206400
6"	threaded	2,000	HU206600
8"	threaded	2,000	HU206800

## Dixon® Boss LPS Hammer Union Caps and Plugs

### Application

- Prevents leakage of hydraulic fracturing fluids from hammer union connections used on manifolds and hose assemblies, hammer union caps and plugs can be used in pressurized service or as dust caps/plugs on site or when transferring equipment

### Features

- Forged steel construction ensures longevity, reliability, and performance
- Caps are designed with larger lugs for easier installation and disassembling and include a threaded bolt hole for attaching chain or cable
- Plugs are designed with larger handle for easier installation and disassembling and include a handle hole to attach chain or cable
- Forged steel meets AISI standards



### Blanking Caps

Size	Figure	Description	Forged Steel Part #
2"	206	includes nut/plug body, O-ring, and retaining ring	HUC206200
4"	100	blanking cap, includes nut/plug body, O-ring, and retaining ring	HUC100400
	206	includes nut/plug body, O-ring, and retaining ring	HUC206400
		blue with nut/plug body and retaining ring with bolt and chain	HUC206400BC
		cap only	HUC207400
	207	blanking cap with bolt and chain	HUC207400BC
6"	206	includes nut/plug body, O-ring, and retaining ring	HUC206600
8"	206	includes nut/plug body, O-ring, and retaining ring	HUC206800



HUC207400

### Blanking Plugs

Size	Figure	Description	Casting Part #
4"	207	plug only	HUP207400
		with chain and D-link (shackle/bolt)	HUP207400DC
6"	100/200/206	hammer union, connects to figures 100/200/206	HUPALL600
8"	100/200/206	hammer union, connects to figures 100/200/206	HUPALL800



HUP207400



HUPALL600

### Low Pressure Blanking Plugs

Size	Figure	Description	Forged Steel Part #
5"	50	hammer union, working pressure 500 PSI	HUSP500



HUSP500

### O-ring

Size	Nitrile Rubber Part #
4"	O429BU



## Dixon® Boss LPS One-Piece Flange Adapters

### Applications

- Used in the transfer of water, brine, water-based chemicals, water-based acids, and gelatinous proppant (sand) slurry used at hydraulic fracturing sites
- Use with HU200400RN two-piece nut

### Features

- Flange x female or male hammer union straights (standard or short length)
- 45° elbows in female and male (flange x hammer union)
- No welds or pipe threads to deteriorate and cause premature leakage
- Two-piece nut is pinned and bolted for perfect alignment
- All 4" Figure 206 threads are interchangeable with other reliable brands
- 125# flange match the bolt pattern of 150# flange
- Iron adapters meet ASTM standards
- Forged steel nuts meet AISI standards

### Flange Adapters - Straight



HUF206400FLG

Size	Figure	Description	Overall Length	Iron Part #
4"	206	female hammer union x 125# flange	5-1/8"	HUF206400FLG
		male hammer union x 125# flange includes nut and nitrile rubber O-ring	5-9/16" (with nut)	HUM206400FLG
6"	100/200/206	125# flange x female hammer union; connects to figures 100/200/206	4-1/2"	HUFALL600FLG
	206	125# flange x male (includes iron nut and O-ring)	4-15/16"	HUM206600FLG <sup>1</sup>
8"	100/200/206	125# flange x female hammer union; connects to figures 100/200/206	4-1/2"	HUFALL800FLG
	206	125# flange x male (includes nut and O-ring)	5-7/32"	HUM206800FLG <sup>1</sup>

<sup>1</sup> Nut is iron

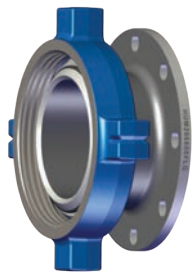

HUM206400FLG-ST

### Flange Adapters - Short

Size	Figure	Description	Overall Length	Iron Part #
4"	206	female hammer union x 125# flange short	3"	HUF206400FLG-ST
		male hammer union x 125# flange short includes nut and nitrile rubber O-ring	3-13/32" (with nut)	HUM206400FLG-ST

### Flange Adapters - 45° Elbow



HUM206400FLG-45

Size	Figure	Description	Overall Length	Iron Part #
4"	206	female hammer union x 125# flange 45° elbow	10-31/32"	HUF206400FLG-45
		male hammer union x 125# flange 45° elbow includes nut and nitrile rubber O-ring	12-1/32" (with nut)	HUM206400FLG-45

### O-ring

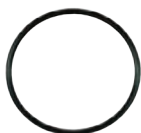

Size	Nitrile Rubber Part #
4"	O347BU

NOTE: For flange dimensions, diagrams and additional information please reference [dixonvalve.com](http://dixonvalve.com).

## Dixon® Boss LPS One-Piece Adapters

### 150# Flange to Weld Adapters

**Features**

- Used on a 12" pipe manifold
- Easy to weld
- Formed butt weld provides accurate alignment
- Compatible with other reliable brands

Size	Description	Weldable Cast Steel Part #
4"	150# flange with offset hole alignment to center weld on 12" manifold pipe x 3-3/4" long adapter	WC4FL12X375-2
	150# flange with offset hole alignment to center weld on 12" manifold pipe x 6-3/4" long adapter	WC4FL12X675-2
	150# flange x weld adapter, vertical	WA4FL12X750-1
	150# flange x weld adapter, offset	WA4FL12X750-2
	150# flange x weld adapter, vertical	WA4FL12X1050-1
	150# flange x weld adapter, offset	WA4FL12X1050-2



10-1/2"



**Vertical Pattern**



**Offset Pattern**

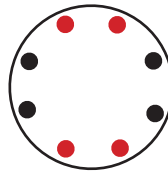

NOTE: For flange dimensions, diagrams and additional information, please reference [dixonvalve.com](http://dixonvalve.com).

### 125# Flange x Male NPT

Size	Description	Ductile Iron Part #
4"	125# flange x male NPT	4FAMT
	125# flange x male NPT - long	4FAMTL



4FAMT

### Port Adapter

Size	Figure	Description	Iron Part #
2"	206	male NPT x female hammer union	HUF206200MT



### Hammer Union Elbows

**Features**

- No welds or pipe threads to deteriorate and cause premature leakage
- Easy to weld to 12" pipe manifolds

Size	Figure	Description	Ductile Iron Part #
4"	206	male hammer union x female hammer union 45° elbow	HUMF20640045
		male hammer union x female hammer union 60° elbow	HUMF20640060
		male hammer union x female hammer union 80° elbow	HUMF20640080
		male hammer union x female hammer union 90° elbow	HUMF20640090



HUMF20640080

## King Crimp® Style Sleeves

## Large Sleeves

Hose I.D.	Sleeve I.D.	Sleeve Wall Thickness	Sleeve Overall Length	Carbon Steel Part #
6"	6.44"	0.120"	5.50"	S6438X550X120CS
	7.00"	0.120"	4.00"	S700X400X120CS
	7.00"	0.120"	6.00"	S700X600X120CS
8"	8.30"	0.120"	8.75"	S830X875X120CS
	8.38"	0.120"	6.00"	S838X600X120CS
	8.50"	0.120"	6.50"	S850X650X120CS
	8.75"	0.120"	6.00"	S875X600X120CS
	8.98"	0.120"	8.75"	S898X875X120CS
	9.00"	0.090"	4.00"	S900X400X090CS
	9.00"	0.120"	4.00"	S900X400X120CS
	9.00"	0.120"	6.00"	S900X600X120CS
	9.10"	0.120"	4.00"	S910X400X120CS
	9.12"	0.120"	6.00"	S912X600X120CS
	9.15"	0.120"	6.00"	S915X600X120CS
	9.25"	0.120"	4.00"	S925X400X120CS
	9.25"	0.120"	6.00"	S925X600X120CS
	9.50"	0.120"	4.00"	S950X400X120CS
	9.50"	0.120"	6.00"	S950X600X120CS
10"	9.75"	0.120"	6.00"	S975X600X120CS
	10.25"	0.120"	7.50"	S1025X750X120CS
	10.50"	0.120"	7.50"	S1050X750X120CS
	11.00"	0.120"	6.00"	S1100X600X120CS
	11.25"	0.120"	7.50"	S1125X750X120CS
	11.75"	0.120"	6.00"	S1175X600X120CS
12"	11.75"	0.120"	7.50"	S1175X750X120CS
	12.44"	0.120"	9.00"	S1244X900X120CS
	12.75"	0.120"	8.00"	S1275X800X120CS
	13.25"	0.120"	7.50"	S1325X750X120CS
	13.25"	0.120"	8.00"	S1325X800X120CS
	13.25"	0.120"	9.50"	S1325X950X120CS
14"	13.75"	0.120"	7.50"	S1375X750X120CS
	14.00"	0.120"	8.00"	S1400X800X120CS
	14.00"	0.120"	9.50"	S1400X950X120CS

NOTE: Consult Dixon® for additional sleeve sizes

D



## King Crimp® Style

### Combination Nipples - Heavy Duty, Threaded End

#### Application

- Used in the fast-paced transfer of water, chemicals, and sand slurry to a hydraulic fracturing site

#### Feature

- Used with ferrules below

#### Specifications

- Water and petroleum transfer hoses rated from **100 to 300 PSI WP** (4:1 SF) have excellent test results with the standard King Crimp ferrules CF400-xxCS.
- 400 PSI** working pressure at **70°F (21°C)** when used with heavy duty crimp ferrules (CF400-6CSHD through CF400-16CSHD)



Size	Description	Schedule 80 Steel Part#
4"	male NPT fitting	STC40CSHD

### Ferrules - Heavy Duty

Only use the crimp style shanks with the crimp style sleeves and ferrules. Due to differences in dimensions and tolerances for safety reasons, do not interchange other manufacturers' products with Dixon® products.



#### Specifications

- 400 PSI** working pressure with a minimum 4:1 safety factor (hose burst: hose working pressure) is only achieved with heavy duty (HD) crimp ferrules, CF400-6CSHD through CF400-16CSHD using heavy duty King Crimp stem STC40CSHD

Hose I.D.	Hose O.D.		Ferrule Wall Thickness	Ferrule I.D.	Ferrule Overall Length	Carbon Steel Part #
	From	To				
4"	4-33/64"	4-36/64"	0.120"	4.625"	4"	CF400-6CSHD
	4-37/64"	4-40/64"	0.120"	4.688"	4"	CF400-7CSHD
	4-41/64"	4-44/64"	0.120"	4.750"	4"	CF400-8CSHD
	4-45/64"	4-48/64"	0.120"	4.813"	4"	CF400-9CSHD
	4-49/64"	4-52/64"	0.120"	4.875"	4"	CF400-10CSHD
	4-53/64"	4-56/64"	0.120"	4.938"	4"	CF400-11CSHD
	4-57/64"	4-60/64"	0.120"	5.000"	4"	CF400-12CSHD
	4-61/64"	5"	0.120"	5.063"	4"	CF400-13CSHD
	5-1/64"	5-4/64"	0.120"	5.125"	4"	CF400-14CSHD
	5-5/64"	5-8/64"	0.120"	5.188"	4"	CF400-15CSHD
	5-9/64"	5-12/64"	0.120"	5.250"	4"	CF400-16CSHD



## Dixon® Boss LPS Butterfly Valves

### Applications

- Low-pressure transfer of water, acids, chemicals, slurries, and other liquids
- Designed for all low-pressure hydraulic fracturing applications

### Sizes

- 4", 5", 8"

### Features

- Locator notches around the outer edge of the body allow the valve to easily line up at center
- Actuator mounting flange outfitted with both industry standard and ISO bolt circle diameters
- Thicker stems deliver a more durable and reliable performance
- Grease zerk added to body neck for reliable performance
- 10-position throttling handle for controlled accuracy
- For use between lightweight flanges: 125 lb., 150 lb., or butterfly valve flange
- Valve is rebuildable; contact Dixon for replacement parts

### Materials

- Body: ductile iron
- Disc: nickel-plated ductile iron
- Seat: nitrile rubber or FKM
- Bushings: PTFE
- O-rings: nitrile rubber
- Stems: 416 stainless steel
- Retaining pins: stainless steel
- Handle: malleable iron

### Specifications

- Maximum working pressure: 4" and 5" - **200 PSI**; 8" - **175 PSI**
- Temperature range:
- Nitrile rubber seat **-20°F to 200°F (-28°C to 93°C)**; FKM seat **0°F to 200°F (-17°C to 93°C)**



Actuated Butterfly Valve

Size	Description	Dixon Part #
4"	valve with nitrile rubber seat	4BF416DITF-CNBR
	valve with FKM seat	4BF416DITF-FKM
5"	valve with nitrile rubber seat	5BF416DITF-NBR
8"	valve with nitrile rubber seat	8BF416DITF-NBR

NOTE: Dixon provides actuation services for industrial and sanitary valves.

### Dimensions

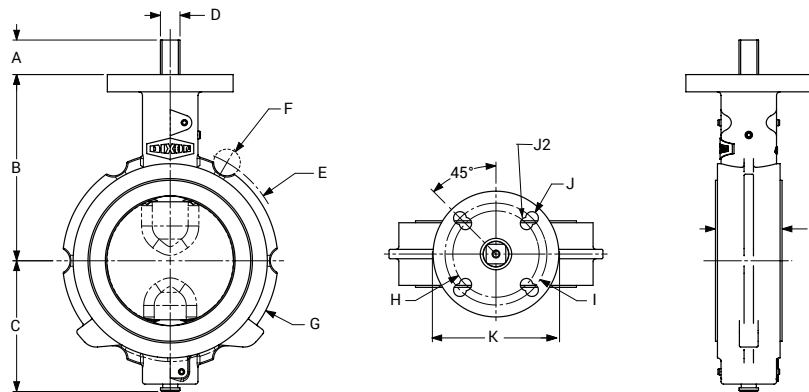

Size	A	B	C	D	E	F	G	H	I	J	J2	K	L
4"	1-3/32"	5-15/16"	4-3/16"	5/8"	7-1/4"	6 x 27/32"	6-7/8"	2-3/4"	3-1/4"	4 x 13/32"	4 x 13/32"	4"	2-1/8"
5"	1-1/4"	6-1/32"	4-27/32"	5/8"	7-19/32"	6 x 3/4"	7-3/4"	2-3/4"	3-1/4"	4 x 13/32"	4 x 7/16"	4"	2-3/16"
8"	1-1/4"	8-1/8"	7-1/16"	7/8"	11-3/4"	8 x 15/16"	11-3/4"	4-1/32"	5"	4 x 1/2"	4 x 19/32"	6"	2-5/8"



## Frac Pump Elbow Adapters

### Applications

- Simplifies the plumbing to and from pumps
- Eliminates multiple adapters and thread connections

### Features

- Used with RZL positive displacement frac pumps
- Reduces leak paths
- 90° elbows that reduces leak paths

### Material

- Seal: rubber (styrene butadiene)

### Specifications

- Working pressure: **250 PSI**
- 316 stainless steel meets AISI standards

#### Male Cam & Groove Adapter x NPSM swivel nut

Size	316 Stainless Steel Part #
1" x 1-1/2"	RPDA901510
1-1/2" x 1-1/2"	RPDA90150



#### Male NPT x NPSM swivel nut

Size	316 Stainless Steel Part #
1" x 1-1/2"	RPDM901510
1-1/2" x 1-1/2"	RPDM90150



## Vent-Lock® Safety Cam and Groove Couplings

### Application

- Transfer of fluids and solids, with a safer disconnection

### Features

- Safety release cam and groove couplings permit the release of static pressure when disconnecting hose assemblies
- Venting system protects operator from being sprayed with hazardous or non-hazardous fluids or solids
- Does not interchange with standard cam and groove products use only with Dixon L-style fittings 
- Safety orange cam arms
- Consult Dixon for availability of other materials

### Specifications

- Rated to **250 PSI**, recommendation based on the use of mating Dixon® L-style fittings at ambient temperature **70°F (21°C)** with standard nitrile rubber seal installed, for use at elevated temperature or other unusual operating conditions, consult Dixon
  - 1", 1-1/2", and 2" sizes have a maximum working pressure of **250 PSI**
  - 3" maximum working pressure **150 PSI** with King Crimp® ferrules, crimp sleeves, and bands at **125 PSI**
  - 4" maximum working pressure **150 PSI** with King Crimp ferrules, crimp sleeves, and bands at **100 PSI**

### Attachment Options

- Ferrules, sleeves, bands, and other reliable options

### Type A Adapters

#### Adapter x Female NPT



Size	316 Stainless Steel Part #	Aluminum Part #
1"	L100-A-SS	---
1-1/2"	L150-A-SS	---
2"	L200-A-SS	---
3"	L300-A-SS	---
4"	---	L400-A-AL

### Type C Couplers

#### Coupler x Hose Shank



Size	316 Stainless Steel Part #
1"	L100-C-SS
1-1/2"	L150-C-SS
2"	L200-C-SS

### EZ Boss-Lock Type C Couplers

#### Coupler x Hose Shank



Size	316 Stainless Steel Part #	Aluminum Part #
1"	RLC100EZ	---
1-1/2"	RLC150EZ	---
2"	RLC200EZ <sup>1</sup>	---
3"	RLC300EZ <sup>1</sup>	---
4"	---	ALC400EZ <sup>1</sup>

<sup>1</sup> Has drop shank

## Vent-Lock® Safety Cam and Groove Couplings

### Type D Couplers

Coupler x Female NPT

Size	316 Stainless Steel Part #
1"	RLD100EZ
1-1/2"	RLD150EZ
2"	RLD200EZ

**D**

### Type E Adapters

Adapter x Hose Shank

Size	316 Stainless Steel Part #
1"	L100-E-SS
1-1/2"	L150-E-SS
2"	L200-E-SS
3"	L300-E-SS



### Type DC Dust Caps

Size	316 Stainless Steel Part #
1"	L100-DC-SS
1-1/2"	L150-DC-SS
2"	L200-DC-SS



### Type DP Dust Plugs

Size	316 Stainless Steel Part #
1"	L100-DP-SS
1-1/2"	L150-DP-SS
2"	L200-DP-SS
3"	L300-DP-SS



### EZ Boss-Lock Type H Dust Caps

Size	316 Stainless Steel Part #
1"	RLH100EZ
1-1/2"	RLH150EZ
2"	RLH200EZ
3"	RLH300EZ



## Vent-Lock® Safety Cam and Groove Couplings

### Accessories

#### Dixon® Handle Assembly

##### Features

- Use only with Dixon Vent-Lock couplers
- Includes handle, ring, and pin



Size	316 Stainless Steel Part #
1"	L100-HSCR-P-SI
1-1/2" - 2"	L200-HSCR-P-SI

#### EZ Boss-Lock Handle Assembly

##### Features

- Use only with EZ Boss-Lock Vent-Lock couplers
- Includes handle, ring, and pin

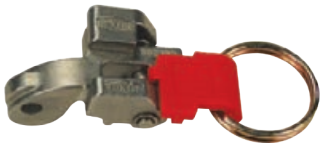

Size	316 Stainless Steel Part #
1"	LRHEZ175
1-1/2" - 2"	LRHEZ152
3"	LRHEZ34

**Universal Couplings.....180 - 189**

Air King® ..... 180 - 181  
 Global Air King ..... 182 - 183  
 Air King with ferrule.....184  
 Air King with gauge port .....184  
 Air King universal swivels.....184  
 Global Air King ferrules .....185  
 Air King clamps .....185  
 Air King accessories .....186  
 Sand Blast .....187  
 Surelock™ ..... 188 - 189

**Quick Disconnects.....190 - 225**

Dix-Lock® N-Series ..... 190 - 193  
 Dual-Lock P-Series ..... 194 - 196  
 DF-series ..... 197 - 201  
 J-series ..... 202 - 203  
 M-series ..... 204 - 205  
 CJ-series .....206  
 SHD-series ..... 207 - 208  
 L-series .....208  
 U-series .....209  
 NK-series.....210  
 BR-series.....211  
 A-series ..... 212 - 213  
 Profile Chart .....214  
 Ball swivel plug.....214  
 Air Chief industrial..... 215 - 218  
     Air Chief plugs ..... 215 - 216  
     Air Chief semi-automatic .....217  
     Air Chief automatic .....218  
 Parker E-z-mate.....219  
 Legris automatic safety couplers .....220  
 Air Chief automotive ..... 221 - 222  
 Air Chief ARO interchange ..... 223 - 224  
 Air Chief Lincoln interchange .....225

**Steel 3500 nipples..... 226**

**Bent Stem Swivels..... 227**

**D.O.T. Air Brake .....228 - 239**

D.O.T. push-in fittings ..... 228 - 229  
 Legris D.O.T. push-in fittings ..... 230 - 233  
 Air brake..... 234 - 239

**Push-in.....240 - 258**

Brass..... 240 - 243  
 Stainless steel Legris..... 244 - 245  
 Nickel-plated brass Legris ..... 246 - 247  
 Nylon / Nickel-plated brass Legris ..... 248 - 250, 252  
 Nylon Legris.....251  
 Manifold, Legris.....252  
 Fittings kit, Legris.....252  
 Valves ..... 253 - 255  
     Ball .....253  
     Quick exhaust .....253  
     Flow control ..... 253 - 254  
     Check .....255  
 Metric..... 256 - 258



**⚠ WARNING**

The constant vibration created by air tools, like air drills and pavement breakers, is destructive to air hose couplings, especially the quick-acting type. To provide protection against coupling breakage and related hazards, Dixon® recommends the use of a whip hose. To construct a whip hose, connect one end of a short (3' to 10') air hose to the air tool using a 3500 type steel nipple. Connect the other end of the hose to the air supply using the standard quick-acting coupling. The heat-treated 3500 nipple will withstand vibration far better than the standard coupling and provide a safer connection. The whip hose should remain permanently connected to the tool.

Air King®

**⚠ WARNING**

- The use of an Air King safety clip or wire type retainer is necessary to ensure Air King universal couplings will not become accidentally disconnected. This guarantees the fittings are properly connected because the safety pin will not go through the holes in mating flanges until couplings are locked in place. Only one Air King safety clip or wire type retainer is required for each Air King universal coupling.

**Features**

- Can be used with Air King ferrules
- Supplied with safety clip
- Supplied with rubber washers, part # AWR4

**Specifications**

- Pressure rating: **150 PSI** at ambient temperature **70°F (21°C)**
- Meets pressure requirements as specified in A-A-59553 commercial item description superseding Mil Spec.WWC-633D

**2-Lug Hose Ends**

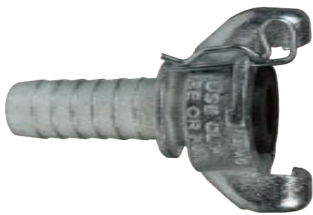

Size	Iron Part #	Optional Qty	Brass Part #	Optional Qty	316 Stainless Steel Part #
3/8"	AMH <sup>1</sup>	25	GABH <sup>1</sup>	25	RAMH
1/2"	AM1	50	GAB1 <sup>1</sup>	50	RAM1
5/8"	AM5	50	AB5	50	---
3/4"	AM6	50	GAB6 <sup>1</sup>	50	RAM6
1"	AM11	50	GAB11 <sup>1</sup>	50	RAM11

**2-Lug Male NPT Ends**



Size	Iron Part #	Optional Qty	Brass Part #	Optional Qty	316 Stainless Steel Part #
1/4"	AMB1	25	ABB1	25	---
3/8"	AMB	25	ABB	25	RAMB
1/2"	AM2	50	GAB2 <sup>1</sup>	50	RAM2
3/4"	AM7	50	GAB7 <sup>1</sup>	50	RAM7
1"	AM12	50	GAB12 <sup>1</sup>	50	RAM12

**2-Lug Female NPT Ends**



Size	Iron Part #	Optional Qty	Brass Part #	Optional Qty	316 Stainless Steel Part #
1/4"	AMC1	25	ABC1	25	---
3/8"	AMC	25	ABC	25	RAMC
1/2"	AM3	50	GAB3 <sup>1</sup>	50	RAM3
3/4"	AM8	50	GAB8 <sup>1</sup>	50	RAM8
1"	AM13	50	GAB13 <sup>1</sup>	50	RAM13

<sup>1</sup> Global investment cast

NOTE: Air King is for air and water service only, Warning: Never use any Air King coupling for steam service! None of Dixon's catalog information is to be interpreted to mean that this type of coupling is suitable for use on steam hose. 

E

## Air King®

### 2-Lug Blank Ends

Iron Part #	Optional Qty	Brass Part #	Optional Qty	316 Stainless Steel Part #
AM0	25	GAB0 <sup>1</sup>	25	RAM0



### 2-Lug Triple Connections

Iron Part #	Optional Qty	Brass Part #	Optional Qty
AM10	25	GAB10 <sup>1</sup>	25



E

<sup>1</sup> Global investment cast

### 4-Lug Hose Ends

Size	Iron Part #	Optional Qty
1-1/4"	AM16	25
1-1/2"	AM21	25
2"	AM26	10



### 4-Lug Female NPT Ends

Size	Iron Part #	Optional Qty
1-1/4"	AM18	25
1-1/2"	AM23	25
2"	AM28	10



NOTE: Air King is for air and water service only. Warning: Never use any Air King coupling for steam service! None of Dixon's catalog information is to be interpreted to mean that this type of coupling is suitable for use on steam hose. 

## Global Air King®

### Features

- Supplied with safety clip and rubber washers
- Use with Boss® clamps; see pages 161 - 162
- Not to be used for steam service 
- Must use safety clips, safety clips are same size for both 2-lug and 4-lug Air King couplings, see page 186

### Specification

- Pressure rating: 150 PSI at ambient temperature 70°F (21°C)

### 2-Lug Hose Ends



Size	Plated Steel Part #	Pkg Qty
1/2"	GAM1	25
3/4"	GAM6	50
1"	GAM11	50

### 2-Lug Male NPT Ends



Size	Plated Steel Part #	Pkg Qty
1/2"	GAM2	25
3/4"	GAM7	50
1"	GAM12	50

### 2-Lug Female NPT Ends



Size	Plated Steel Part #	Optional Qty
1/2"	GAM3	25
3/4"	GAM8	50
1"	GAM13	50

### 2-Lug Blank End



Plated Steel Part #	Optional Qty
GAM0	25

### 2-Lug Triple Connection



Plated Steel Part #	Optional Qty
GAM10	25

NOTE: Air King is for air and water service only. Warning: Never use any Air King coupling for steam service! None of Dixon's catalog information is to be interpreted to mean that this type of coupling is suitable for use on steam hose. 

E



**Global Air King®**

**4-Lug Hose Ends**

Size	Plated Steel Part #	Optional Qty
1-1/4"	GAM16	25
1-1/2"	GAM21	25
2"	GAM26	10

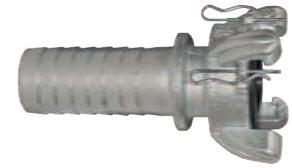

**4-Lug Female NPT Ends**

Size	Plated Steel Part #	Optional Qty
1-1/4"	GAM18	25
1-1/2"	GAM23	25
2"	GAM28	20



**E**

NOTE: Air King is for air and water service only. Warning: Never use any Air King coupling for steam service! None of Dixon's catalog information is to be interpreted to mean that this type of coupling is suitable for use on steam hose. 

### Air King® with Ferrule

**Features**

- Design provides quick, easy, and effective coupling of air hose
- Interlocking ferrule can be crimped or swaged to achieve maximum coupling sealing and retention with a low-profile streamline appearance. For crimp or swage diameter recommendations go to [dixonvalve.com](http://dixonvalve.com)
- For air and water service only

**Specification**

- Working pressure: 150 PSI at ambient temperature 70°F (21°C)



Size	Hose O.D.		Iron Part #	316 Stainless Steel Part #
	From	To		
1/2"	5/16"	1-1/8"	AM1WF	RAM1WF
3/4"	1/2"	1-1/4"	AM6WF	RAM6WF
1"	1-1/8"	1-3/8"	AM11WF-1	---
1"	1-3/16"	1-1/2"	AM11WF	---
1"	2-1/16"	2-1/4"	AM21WF	---
2"	2-1/4"	2-3/4"	AM26WF	---

### Air King with Gauge Port

**Features**

- Drilled with 1/4" NPT port for mounting a gauge
- Gauge sold separately



Size	Iron Part #	316 Stainless Steel Part #
3/4"	AM7T	RAM7T

### Air King Couplings

#### Swivel Hose End

**Features**

- Interchanges with other Air King fittings
- Includes a heavy-duty, free-turning joint that swivels under pressure to prevent hose kinking
- For air and water service only

**Specification**

- Working pressure: 150 PSI at ambient temperature 70°F (21°C)



Size	Iron Part #
3/4"	AM6SWIV

#### Swivel Male NPT Ends



Size	Iron Part #
1/2"	AM2SWIV
3/4"	AM7SWIV

#### Swivel Female NPT End



Size	Iron Part #
3/4"	AM8SWIV

NOTE: Air King is for air and water service only. Warning: Never use any Air King coupling for steam service! None of Dixon's catalog information is to be interpreted to mean that this type of coupling is suitable for use on steam hose.



E

## Global Air King® Ferrules

### Features

- Low profile streamline appearance with maximum retention
- Lightweight
- Can be crimped
- Designed for use with global Air King fittings on pages 182 - 183
- Reference dixonvalve.com for crimp recommendations and ferrule O.D. ranges

Size	Ferrule I.D.	Plated Steel Part #
1/2"	0.906"	CCF0906
3/4"	1.120"	CCF1120
	1.149"	CCF1149
	1.190"	CCF1190
	1.218"	CCF1218
	1.246"	CCF1246
1"	1.438"	CCF1438
	1.469"	CCF1469
	1.500"	CCF1500
	1.531"	CCF1531



E

## Air King Clamps

### Features

- Torque values for clamps are based on dry bolts. The use of lubricant on bolts will adversely effect clamp performance.
- For use with Air King ends on pages 180 - 181



Hose I.D.	Hose O.D.		Plated Iron Part #	Torque ft. lbs.	Optional Qty
	from	to			
3/8"	44/64"	56/64"	CD <sup>2</sup>	6	100
1/2"	1"	1-12/64"	A4	6	50
3/4"	1-8/64"	1-20/64"	A9 <sup>2</sup>	21	50
1"	1-20/64"	1-32/64"	A10 <sup>1,2</sup>	21	50
	1-32/64"	1-52/64"	A14	21	50



<sup>1</sup> Can be used with AM6 and AM11

<sup>2</sup> Global investment cast carbon steel

## Air King® Accessories

### Features

- The use of an Air King safety clip or wire type retainer is necessary to ensure couplings will not become accidentally disconnected, this guarantees the fittings are properly connected as the pin will not go through the holes in the mating flanges until couplings are locked in place
- Only one Air King safety clip or wire type retainer is required for each Air King universal coupling
- Sold in package quantities only

### Standard Safety Clip

#### Feature

- Same size clip can be used for all coupling sizes



Wire Diameter	Part #	Pkg Qty
.080	AC1	25

### Safety Pins

#### Feature

- Heavy duty, oversized



Wire Diameter	Part #
.058	AKSP1
.091	AKSP25

### Synthetic Lanyard

#### Features

- Synthetic cord
- Same size for all coupling sizes



Part #	Pkg Qty
ACL8	25

### 2-Lug Washers

#### Features

- 2-lug couplings use the same size washer, part number's AWR4, AWS6
- Neoprene is oil resistant



AWR4



AWS6

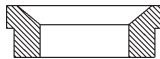

#### Specifications

- Rubber temperature range: -20°F to 160°F (-29°C to 71°C)
- Neoprene temperature range: -20°F to 190°F (-29°C to 88°C)

Style	Rubber Part #	Neoprene Part #	Pkg Qty
2 lug	AWR4 <sup>1</sup>	AWS6	50

<sup>1</sup> Made from styrene-butadiene (SBR)

### 4-Lug Washer

#### Features

- 4-lug couplings use the same size washer, part number AWR14



#### Specifications

- Rubber temperature range: -20°F to 160°F (-29°C to 71°C)

Style	Rubber Part #
4 lug	AWR14

E

## Sand Blast Couplings

### Features

- Designed for use on sand blast hose
- Supplied with screws
- Nozzle holders have 1-1/4" NPSM thread
- Abrasive blasting equipment must have hose safety cables (page 261) or hose coupling safety locks installed to read safety clips



### Specification

- Pressure: **110 PSI** at ambient temperature **70°F (21°C)**

### Installation

- 1) Ends of hose must be cut square to fit snug against metal end
- 2) Holding hose tight to end of fitting, insert screws and turn in full, putting screw 180° from first to ensure best centering
- 3) After all screws have been placed, check tube opposite screws to be sure screws have not penetrated completely through
- 4) On quick couplings, insert safety clips

### Hose Ends

Hose Size	Hose O.D.	Brass Part #	Aluminum Part #
3/4"	1-1/2"	BSB75	ASB75
1"	1-7/8"	BSB100	ASB100
1-1/4"	2-5/32"	BSB125	ASB125
1-1/2"	2-3/8"	BSB150	ASB150



### Nozzle Holders

Hose Size	Hose O.D.	Brass Part #	Aluminum Part #
3/4"	1-1/2"	BNH75	ANH75
1"	1-7/8"	BNH100	ANH100
1-1/4"	2-5/32"	BNH125	ANH125
1-1/2"	2-3/8"	BNH150	ANH150



### Female Threaded Ends

Hose Size	Brass Part #	Aluminum Part #
1-1/4"	BSC125	ASC125
1-1/2"	BSC150	ASC150



NOTE: Does not include screws

### Replacement Parts

Description	Part #
black nitrile replacement gasket	SBG
urethane replacement gasket	USBG
replacement screws for sand blast couplings (sold in package quantity of 8 only)	SBCS



black nitrile



urethane

## Sure-Lock™ Couplings

### Applications

- Coupling for air only, commonly used in construction and mining; excels in services where ease, economy, safety, and speed are paramount

### Features

- Pressure-activated gasket allows for easy coupling (less than 15 lbs. of force is required to connect the coupling gaskets seal upon introduction of line pressure)
- Safety pin is supplied with each coupling and is required as a safety precaution 

### Materials

- Body: SG iron AS1831 400-250-12
- Bellow seal: natural rubber (patent pending), other seal material available upon request

### Specification

- Working pressure: **200 PSI** at ambient temperature **70°F (21°C)**

#### Hose Ends

Head	Size	Part#	Optional Qty
small	3/8"	SL038H	50
	1/2"	SL050H	50
	3/4"	SL075H	50
	1"	SL100H	50
medium	1-1/2"	SL150H	15
	2"	SL200H	10

#### Male NPT Ends

Head	Size	Part#	Optional Qty
small	3/8"	SL038M	50
	1/2"	SL050M	50
	3/4"	SL075M	50
	1"	SL100M	50
medium	1-1/2"	SL150M	15
	2"	SL200M	15

#### Female NPT Ends

Head	Size	Part#	Optional Qty
small	3/8"	SL038F	50
	1/2"	SL050F	50
	3/4"	SL075F	50
	1"	SL100F	50
medium	1-1/2"	SL150F	15
	2"	SL200F	15

#### Hose End with Ferrules

### Features

- Design provides quick, easy, and effective coupling of air hose
- Interlocking ferrule can be crimped or swaged to achieve maximum coupling sealing and retention with a low-profile streamline appearance, visit [dixonvalve.com](http://dixonvalve.com) for crimp recommendations
- Dixon® recommends that all hose assemblies be tested in accordance with ARPM testing procedures
- For air service only 

### Specification

- Working pressure: **200 PSI** at ambient temperature **70°F (21°C)**

Head	Size	Hose O.D.		Part #
		From	To	
small	1/2"	1/2"	1-1/32"	SL050CR
	3/4"	3/4"	1-11/32"	SL075CR
	1"	1"	1-23/32"	SL100CR

E



## Sure-Lock™ Couplings

### Blank Ends

Head	Size	Part #	Optional Qty
small	1/2" to 1"	SL00	15
medium	1-1/2" to 2"	SL01 <sup>1</sup>	3

<sup>1</sup> Medium blank end comes with 1" NPT pipe plug



Small blank end



Medium blank end <sup>1</sup>

E

### Three Way Connectors

Head	Size	Part #	Optional Qty
small	1/2" to 1"	SL09	15
medium	1-1/2" to 2"	SL10 <sup>1</sup>	3

<sup>1</sup> Medium three way connector comes with 1" NPT pipe plug



Small three way connector



Medium three way connector <sup>1</sup>

### Safety Locking Pin

The use of a safety locking pin is necessary to ensure that Sure-Lock couplings will not become accidentally disconnected. This guarantees that the fittings are properly connected as the pin will not go through the holes in both couplings until the couplings are locked into place.



Part #	Optional Qty
SLP1	25



### Replacement Seals

Head	Size	Part #
small	1/2" to 1"	SLR1
medium	1-1/2" to 2"	SLR2



Medium

## Dix-Lock® N-Series Interchange Pneumatic Couplings

### Features

- Bowes Interchange Bayonet Style
- Interchangeable with Bowes 51000-Series, National Series 'B', MacDonald Quick-Action, Campbell Single-Lock

### Specifications

- Temperature range: -40°F to 250°F (-40°C to 121°C)
- Pressure rating: 300 PSI in brass, 500 PSI in steel and 303 stainless steel at ambient temperature 70°C (21°C)
- Conforms to MIL-C-3486 and A-A-50431A standards



It is important to be safe when installing quick disconnect couplings into a pneumatic circuit. Never install a pneumatic coupling directly into an air tool, use a piece of hose that is at least 18" long, between the tool and the coupling, to prevent damage to the coupling. To protect the operator, safety devices, such as a safety check valve and safety cable should be installed in case there is a hose or coupling failure. For safety cables and check valves see pages 261, 270, and 910.

E



Brass



Steel



303/316 stainless

### Female Head x Female Threaded End Couplers

Body Size	Threads	Brass Part #	Steel Part #	303 Stainless Steel Part #	316 Stainless Steel Part #
1/2"	3/8"-18 NPTF	4NF3-B	4NF3	---	---
	3/8"-19 BSPP	---	4NBF3	---	---
	1/2"-14 NPTF	4NF4-B	4NF4	---	---
	1/2"-14 BSPP	4NBF4-B	4NBF4	---	---
	3/4"-14 NPTF	4NF6-B	4NF6	4NF6-S	4NF6-SS
	3/4"-14 BSPP	4NBF6-B	4NBF6	---	---
	1"-11-1/2 NPTF	4NF8-B	4NF8	---	4NF8-SS
	1"-11 BSPP	4NBF8-B	4NBF8	---	---



Brass



Steel



303/316 stainless

### Male Head x Female Threaded End Plugs

Body Size	Threads	Brass Part #	Steel Part #	303 Stainless Steel Part #	316 Stainless Steel Part #
1/2"	3/8"-18 NPTF	N4F3-B	N4F3	---	---
	3/8"-19 BSPP	---	N4BF3	---	---
	1/2"-14 NPTF	N4F4-B	N4F4	---	---
	1/2"-14 BSPP	N4BF4-B	N4BF4	---	---
	3/4"-14 NPTF	N4F6-B	N4F6	N4F6-S	N4F6-SS
	3/4"-14 BSPP	N4BF6-B	N4BF6	---	---
	1"-11-1/2 NPTF	N4F8-B	N4F8	---	N4F8-SS
	1"-11 BSPP	N4BF8-B	N4BF8	---	---

### Male Head x Female Threaded End Safety Lock Plugs



Body Size	Threads	Brass Part #
1/2"	1/2" - 14 NPTF	N4F4-B-LS
	3/4" - 14 NPTF	N4F6-B-LS



## Dix-Lock® N-Series Interchange Pneumatic Couplings

### Female Head x Male Threaded End Couplers

Body Size	Threads	Brass Part #	Steel Part #	303 Stainless Steel Part #	316 Stainless Steel Part #
3/8"	1/2" - 14 NPTF	---	3NM4	---	---
	1/2" - 14 BSPT	---	3NBM4	---	---
1/2"	3/8" - 18 NPTF	4NM3-B	4NM3	---	---
	3/8" - 19 BSPT	---	4NBM3	---	---
	1/2" - 14 NPTF	4NM4-B	4NM4	---	---
	1/2" - 14 BSPT	4NBM4-B	4NBM4	---	---
	3/4" - 14 NPTF	4NM6-B	4NM6	4NM6-S	4NM6-SS
	3/4" - 14 BSPT	4NBM6-B	4NBM6	---	---
	1" - 11-1/2 NPTF	4NM8-B	4NM8	---	4NM8-SS
	1" - 11 BSPT	4NBM8-B	4NBM8	---	---



Brass



Steel



303/316 stainless

E

### Male Head x Male Threaded End Plugs

Body Size	Threads	Brass Part #	Steel Part #	303 Stainless Steel Part #	316 Stainless Steel Part #
3/8"	1/2"-14 NPTF	---	N3M4	---	---
	1/2"-14 BSPT	---	N3BM4	---	---
1/2"	3/8"-18 NPTF	N4M3-B	N4M3	---	---
	3/8"-19 BSPT	---	N4BM3	---	---
	1/2"-14 NPTF	N4M4-B	N4M4	---	---
	1/2"-14 BSPT	N4BM4-B	N4BM4	---	---
	3/4"-14 NPTF	N4M6-B	N4M6	N4M6-S	N4M6-SS
	3/4"-14 BSPT	N4BM6-B	N4BM6	---	---
	1"-11-1/2 NPTF	N4M8-B	N4M8	---	N4M8-SS
	1"-11 BSPT	N4BM8-B	N4BM8	---	---



Brass



Steel



303/316 stainless

### Male Head x Male Threaded Safety Lock End Plugs

Body Size	Threads	Brass Part #	Steel Part #	303 Stainless Steel Part #
1/2"	1/2"-14 NPTF	N4M4-B-LS	N4M4-LS	---
	1/2"-14 BSPT	---	N4BM4-LS	---
	3/4"-14 NPTF	N4M6-B-LS	N4M6-LS	N4M6-S-LS
	3/4"-14 BSPT	---	N4BM6-LS	---



Brass



Steel



303 stainless

### Female Head x Standard Hose Barb Couplers

Body Size	Hose I.D.	Brass Part #	Steel Part #	303 Stainless Steel Part #	316 Stainless Steel Part #
3/8"	1/2"	---	3NCS4	---	---
1/2"	3/8"	4NS3-B	4NS3	---	---
	1/2"	4NS4-B	4NS4	---	---
	3/4"	4NS6-B	4NS6	4NS6-S	4NS6-SS
	1"	4NS8-B	4NS8	4NS8-S	4NS8-SS



Brass



Steel



303/316 stainless

**Dix-Lock® N-Series Interchange Pneumatic Couplings**



Brass



Steel



303/316 stainless

**Male End x Hose Barb Plugs**

Body Size	Hose I.D.	Brass Part #	Steel Part #	303 Stainless Steel Part #	316 Stainless Steel Part #
3/8"	1/2"	---	N3CS4	---	---
	3/8"	N4S3-B	N4S3	---	---
1/2"	1/2"	N4S4-B	N4S4	---	---
	3/4"	N4S6-B	N4S6	N4S6-S	N4S6-SS
	1"	N4S8-B	N4S8	N4S8-S	N4S8-SS



Brass



Steel



303 stainless

**Male End x Hose Barb Safety Lock Plugs**

Body Size	Hose I.D.	Brass Part #	Steel Part #	303 Stainless Steel Part #
1/2"	1/2"	N4S4-B-LS	N4S4-LS	---
	3/4"	N4S6-B-LS	N4S6-LS	N4S6-S-LS

**Gender Change Union**



Body Size	Configuration	Steel Part #
1/2"	coupler to coupler	4N4N

**Caps**



Body Size	Cap Lanyard	Brass Part #	Steel Part #
1/2"	steel cable	N4DC-B	N4DC

**Seals**



Body Size	Coupler Style	Nitrile Part #	FKM Part #
3/8"	all	3N-SKIT	---
1/2"	all	4N-SKIT	F-4N-SKIT

E

## Dix-Lock® N-Series Interchange Pneumatic Coupler with Ferrule

### Features

- For crimp recommendations visit [dixonvalve.com](http://dixonvalve.com)
- Also available in stainless steel. Contact Dixon® for further information.

### Materials

- Machined components are manufactured using solid steel, brass, or 303 stainless steel bar stock
- Stainless steel retaining ring and spring maximize corrosion resistance and extend service life
- Steel componentry is plated using RoHS-compliant trivalent chrome

### Specification

- Working pressure: **300 PSI** at ambient temperature **70°F (21°C)**

### Interchange Data

- Bowes Interchange Bayonet Style
- Interchangeable with Bowes 51000-Series, National Series 'B', MacDonald Quick-Action, Campbell Single-Lock

### Seal Components

- Nitrile rubber pneumatically energized seals are standard, temperature range **-40°F to 250°F (-40°C to 121°C)**

#### Female Head with Ferrule

Body Size	Hose I.D.	Hose O.D.		Plated Steel Part #	Brass Part #
		From:	To:		
1/2"	1/2"	54/64"	1-2/64"	4NS4-WF	4NS4-B-WF
	3/4"	1-10/64"	1-22/64"	4NS6-WF	4NS6-B-WF



#### Male Head with Ferrule

Body Size	Hose I.D.	Hose O.D.		Plated Steel Part #	Brass Part #
		From:	To:		
1/2"	1/2"	54/64"	1-2/64"	N4S4-WF	N4S4-B-WF
	3/4"	1-10/64"	1-22/64"	N4S6-WF	N4S6-B-WF



#### Male Locking Head with Ferrule

Body Size	Hose I.D.	Hose O.D.		Plated Steel Part #	Brass Part #
		From:	To:		
1/2"	1/2"	54/64"	1-2/64"	N4S4-LS-WF	N4S4-B-LS-WF
	3/4"	1-10/64"	1-22/64"	N4S6-LS-WF	N4S6-B-LS-WF



## Dual-Lock P-Series Pneumatic Couplings

### Features

- Interchanges with National A type, Campbell Double-Lock, and Thor PHC series couplings
- Spring-loaded interlocking engagement
- Optional locking key prevents sleeve retraction
- Steel componentry is plated using RoHS-compliant trivalent chrome

### Specifications

- Working pressure: **300 PSI** at ambient temperature **70°F (21°C)**
- Nitrile rubber seals are standard temperature range **-40°F to 250°F (-40°C to 121°C)**

E



brass



steel



303 stainless

### Female Thread Couplers

Body Size	Threads	Brass Part #	Steel Part #	303 Stainless Steel Part #
1/2"	1/2" - 14 NPTF	---	4PF4	---
	3/4" - 14 NPTF	4PF6-B	4PF6	4PF6-S



brass



steel



303 stainless

### Female Thread Plugs

Body Size	Threads	Brass Part #	Steel Part #	303 Stainless Steel Part #
1/2"	3/8"-18 NPTF	---	P4F3	---
	1/2"-14 NPTF	P4F4-B	P4F4	---
	3/4"-14 NPTF	P4F6-B	P4F6	P4F6-S
	3/4"-14 NPTF	---	P4F6-9 <sup>1</sup>	---
	1"-11-1/2 NPTF	P4F8-B	P4F8	---

### Male Thread Couplers



steel



303 stainless

Body Size	Threads	Steel Part #	303 Stainless Steel Part #
1/2"	3/8"-18 NPTF	4PM3	---
	1/2"-14 NPTF	4PM4	---
	3/4"-14 NPTF	4PM6	4PM6-S
	3/4"-14 NPTF	4PM6-9 <sup>1</sup>	---
	1"-11-1/2 NPTF	4PM8	---

<sup>1</sup> Steel/PTFE coating

## Dual-Lock P-Series Pneumatic Couplings

### Male Thread Plugs

Body Size	Threads	Brass Part #	Steel Part #	303 Stainless Steel Part #
1/2"	3/8"-18 NPTF	---	P4M3	---
	1/2"-14 NPTF	P4M4-B	P4M4	---
	3/4"-14 NPTF	P4M6-B	P4M6	P4M6-S
	3/4"-14 NPTF	---	P4M6-9 <sup>1</sup>	---
	1"-11-1/2 NPTF	P4M8-B	P4M8	---

<sup>1</sup> Steel/PTFE coating



Brass



Steel



303 stainless

E

### Hose Barb Couplers

Body Size	Hose I.D.	Brass Part #	Steel Part #	303 Stainless Steel Part #
1/2"	3/8"	---	4PS3	---
	1/2"	4PS4-B	4PS4	---
	3/4"	4PS6-B	4PS6	4PS6-S
	3/4"	---	4PS6-9 <sup>1</sup>	---
	1"	4PS8-B	4PS8	---

<sup>1</sup> Steel/PTFE coating



Brass



Steel



303 stainless

### Hose Barb Coupler with Knurled Flanged Sleeves

**Feature**

- Large, raised collar sleeve permits easier handling when wearing gloves

Body Size	Hose I.D.	Trivalent Chrome Plated Steel Part #
1/2"	3/8"	4PS3-FS
	1/2"	4PS4-FS
	3/4"	4PS6-FS



### Male Thread Coupler with Knurled Flanged Sleeves

Body Size	Threads	Trivalent Chrome Plated Steel Part #
1/2"	3/8"-18 NPTF	4PM3-FS
	1/2"-14 NPTF	4PM4-FS
	3/4"-14 NPTF	4PM6-FS



### Female Thread Couplers with Knurled Flanged Sleeves

Body Size	Threads	Trivalent Chrome Plated Steel Part #
1/2"	1/2"-14 NPTF	4PF4-FS
	3/4"-14 NPTF	4PF6-FS



## Dual-Lock P-Series Pneumatic Couplings

### Couplers with Ferrule



E

Body Size	Hose I.D.	Hose O.D.		Trivalent Chrome Plated Steel Part #
		From:	To:	
1/2"	1/2"	54/64"	1-2/64"	4PS4-WF
	3/4"	1-10/64"	1-22/64"	4PS6-WF

### Replacement Seals



Body Size	Coupler Style	Nitrile Part #	FKM Part #
1/2"	all	4P-SKIT	F-4P-SKIT

### Locking Key



#### Feature

- Fits couplings with locking sleeve

Body Size	Coupler Style	Steel Part #
1/2"	all	4P-CLIP

## DF-Series Industrial Pneumatic Couplings

### Features

- Interchanges with other industrial interchange designs
- Interchanges with the MIL-C-4109, A-A 59439, and ISO6150B standards
- Parker 20-series manual interchange (F-series)
- Parker 30-series automatic interchange (D-series)
- Foster 3, 4, 5, and 6 series
- Hansen 1000, 400, and 500 (F-series)
- Hansen 3000, 4000, 5000, and 6000 (D-series)

### Specifications

- Pressure ratings: brass coupler / steel plug: **500 PSI**, brass coupler / brass plug: **300 PSI**, steel coupler / steel plug: **500 PSI**, 303 stainless steel coupler / 303 stainless steel plug: **500 PSI**
- Temperature range: **-40°F to 250°F (-40°C to 121°C)**

It is important to be safe when installing quick disconnect couplings into a pneumatic circuit. Never install a pneumatic coupling directly into an air tool. Use a piece of hose that is at least 18' long, between the tool and the coupling, to prevent damage to the coupling. To protect the operator, safety devices, such as a safety check valve and safety cable should be installed in case there is a hose or coupling failure. For safety check valves and cables see pages 270 and 910. 

### Female Threaded Plugs

Body Size	Threads	Brass Part #	Steel Part #	303 Stainless Steel Part #
1/4"	1/8" - 27 NPTF	---	D2F1	---
	1/4" - 18 NPTF	D2F2-B	D2F2	D2F2-S
	1/4" - 19 BSPP	---	D2BF2	---
	3/8" - 18 NPTF	D2F3-B	D2F3	D2F3-S
3/8"	3/8" - 19 BSPP	---	D2BF3	---
	1/4" - 18 NPTF	---	D3F2	---
	3/8" - 18 NPTF	D3F3-B	D3F3	D3F3-S
	3/8" - 19 BSPP	---	D3BF3	---
1/2"	1/2" - 14 NPTF	---	D3F4	---
	3/8" - 18 NPTF	---	D4F3	---
	1/2" - 14 NPTF	D4F4-B	D4F4	D4F4-S
	1/2" - 14 BSPP	---	D4BF4	---
3/4"	3/4" - 14 NPTF	D4F6-B	D4F6	---
	1/2" - 14 NPTF	---	D6F4	---
	3/4" - 14 NPTF	---	D6F6	---
1"	1" - 11-1/2 NPTF	---	D6F8	---



Brass

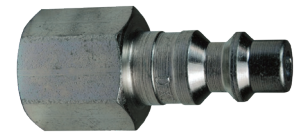

Steel



303 Stainless

### Male Threaded Plugs

Body Size	Threads	Brass Part #	Steel Part #	303 Stainless Steel Part #
1/4"	1/8" - 27 NPTF	D2M1-B	D2M1	D2M1-S
	1/4" - 18 NPTF	D2M2-B	D2M2	D2M2-S
	1/4" - 19 BSPT	---	D2BM2	---
	3/8" - 18 NPTF	D2M3-B	D2M3	D2M3-S
	3/8" - 19 BSPT	---	D2BM3	---
3/8"	1/4" - 18 NPTF	---	D3M2	---
	3/8" - 18 NPTF	D3M3-B	D3M3	D3M3-S
	3/8" - 19 BSPT	---	D3BM3	---
	1/2" - 14 NPTF	---	D3M4	---
1/2"	1/4" - 18 NPTF	---	D4M2	---
	3/8" - 18 NPTF	---	D4M3	---
	1/2" - 14 NPTF	D4M4-B	D4M4	D4M4-S
	1/2" - 14 BSPT	---	D4BM4	---
3/4"	3/4" - 14 NPTF	D4M6-B	D4M6	---
	1/2" - 14 NPTF	---	D6M4	---
	3/4" - 14 NPTF	---	D6M6	---
	1" - 11-1/2 NPTF	---	D6M8	---



Brass



Steel



303 stainless

## DF-Series Industrial Pneumatic Couplings

### Standard Hose Barb Plugs



Brass



Steel



303 stainless

Body Size	Hose I.D.	Brass Part #	Steel Part #	303 Stainless Steel Part #
1/4"	1/4"	D2S2-B	D2S2	D2S2-S
	5/16"	---	D2S2.5	---
	3/8"	D2S3-B	D2S3	D2S3-S
3/8"	1/4"	---	D3S2	---
	3/8"	D3S3-B	D3S3	D3S3-S
	1/2"	---	D3S4	---
1/2"	3/8"	D4S3-B	D4S3	---
	1/2"	D4S4-B	D4S4	D4S4-S
	3/4"	D4S6-B	D4S6	---
3/4"	1/2"	---	D6S4	---
	3/4"	---	D6S6	---
	1"	---	D6S8	---

### Automatic Female Threaded Couplers



Brass



303 stainless

Body Size	Threads	Steel Part #	303 Stainless Steel Part #
1/4"	1/8" - 27 NPTF	2DF1-B	---
	1/4" - 18 NPTF	2DF2-B	2DF2-S
	1/4" - 19 BSPP	2DBF2-B	---
	3/8" - 18 NPTF	2DF3-B	2DF3-S
	3/8" - 19 BSPP	2DBF3-B	---
3/8"	1/4" - 18 NPTF	3DF2-B	---
	3/8" - 18 NPTF	3DF3-B	3DF3-S
	3/8" - 19 BSPP	3DBF3-B	---
1/2"	1/2" - 14 NPTF	3DF4-B	---
	3/8" - 18 NPTF	4DF3-B	---
	1/2" - 14 NPTF	4DF4-B	4DF4-S
	1/2" - 14 BSPP	4DBF4-B	---
3/4"	3/4" - 14 NPTF	4DF6-B	---
	1/2" - 14 NPTF	6DF4-B	---
	3/4" - 14 NPTF	6DF6-B	---
	1" - 11-1/2 NPTF	6DF8-B	---

### Manual Female Threaded Couplers

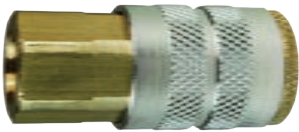

Brass

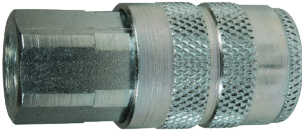

Steel



303 stainless

Body Size	Threads	Brass Part #	Steel Part #	303 Stainless Steel Part #
1/4"	1/8" - 27 NPTF	2FF1-B	---	---
	1/8" - 28 BSPP	2FBF1-B	---	---
	1/4" - 18 NPTF	2FF2-B	2FF2	2FF2-S
	1/4" - 19 BSPP	2FBF2-B	---	---
	3/8" - 18 NPTF	2FF3-B	---	2FF3-S
	3/8" - 19 BSPP	2FBF3-B	---	---
3/8"	1/4" - 18 NPTF	---	3FF2	---
	3/8" - 18 NPTF	---	3FF3	3FF3-S
	3/8" - 19 BSPP	---	3FBF3	---
1/2"	1/2" - 14 NPTF	---	3FF4	---
	3/8" - 18 NPTF	---	4FF3	---
	1/2" - 14 NPTF	---	4FF4	4FF4-S
	1/2" - 14 BSPP	---	4FBF4	---
3/4"	3/4" - 14 NPTF	---	4FF6	---



## DF-Series Industrial Pneumatic Couplings

### Automatic Male Threaded Couplers

Body Size	Threads	Brass Part #	303 Stainless Steel Part #
1/4"	1/8" - 27 NPTF	2DM1-B	---
	1/4" - 18 NPTF	2DM2-B	2DM2-S
	1/4" - 19 BSPT	2DBM2-B	---
	3/8" - 18 NPTF	2DM3-B	2DM3-S
	3/8" - 19 BSPT	2DBM3-B	---
3/8"	1/4" - 18 NPTF	3DM2-B	---
	3/8" - 18 NPTF	3DM3-B	3DM3-S
	3/8" - 19 BSPT	3DBM3-B	---
	1/2" - 14 NPTF	3DM4-B	---
1/2"	3/8" - 18 NPTF	4DM3-B	---
	1/2" - 14 NPTF	4DM4-B	4DM4-S
	1/2" - 14 BSPT	4DBM4-B	---
	3/4" - 14 NPTF	4DM6-B	---
3/4"	1/2" - 14 NPTF	6DM4-B	---
	3/4" - 14 NPTF	6DM6-B	---
	1" - 11-1/2 NPTF	6DM8-B	---



Brass



303 stainless



### Manual Male Threaded Couplers

Body Size	Threads	Brass Part #	Steel Part #	303 Stainless Steel Part #
1/4"	1/8" - 27 NPTF	2FM1-B	---	2FM1-S
	1/4" - 18 NPTF	2FM2-B	2FM2	2FM2-S
	1/4" - 19 BSPT	2FBM2-B	---	---
	3/8" - 18 NPTF	2FM3-B	---	2FM3-S
	3/8" - 19 BSPT	2FBM3-B	---	---
3/8"	1/4" - 18 NPTF	---	3FM2	---
	3/8" - 18 NPTF	---	3FM3	3FM3-S
	3/8" - 19 BSPT	---	3FBM3	---
	1/2" - 14 NPTF	---	3FM4	---
1/2"	3/8" - 18 NPTF	---	4FM3	---
	1/2" - 14 NPTF	---	4FM4	4FM4-S
	1/2" - 14 BSPT	---	4FBM4	---
	3/4" - 14 NPTF	---	4FM6	---



Brass



Steel



303 stainless

## DF-Series Industrial Pneumatic Couplings

### Automatic Standard Hose Barb Couplers



Brass



303 stainless

Body Size	Hose I.D.	Brass Part #	303 Stainless Steel Part #
1/4"	1/4"	2DS2-B	2DS2-S
	3/8"	2DS3-B	2DS3-S
3/8"	1/4"	3DS2-B	---
	3/8"	3DS3-B	3DS3-S
	1/2"	3DS4-B	---
1/2"	3/8"	4DS3-B	---
	1/2"	4DS4-B	4DS4-S
	3/4"	4DS6-B	---
3/4"	1/2"	6DS4-B	---
	3/4"	6DS6-B	---
	1"	6DS8-B	---

### Manual Standard Hose Barb Couplers



Brass



Steel

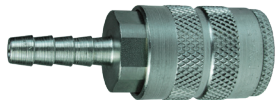

303 stainless

Body Size	Hose I.D.	Brass Part #	Steel Part #	303 Stainless Steel Part #
1/4"	1/4"	2FS2-B	2FS2	2FS2-S
	5/16"	2FS2.5-B	---	---
	3/8"	2FS3-B	---	2FS3-S
3/8"	1/4"	---	3FS2	---
	3/8"	---	3FS3	3FS3-S
	1/2"	---	3FS4	---
1/2"	3/8"	---	4FS3	---
	1/2"	---	4FS4	4FS4-S
	3/4"	---	4FS6	---

## DF-Series Industrial Pneumatic Couplings

### Automatic Push-Loc Barb Couplers

Body Size	Hose I.D.	Brass Part #
1/4"	1/4"	2DB2-B
	3/8"	2DB3-B
3/8"	3/8"	3DB3-B
1/2"	1/2"	4DB4-B

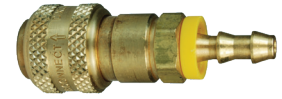

### Manual Push-Loc Barb Couplers

Body Size	Hose I.D.	Brass Part #	Steel Part #
1/4"	1/4"	2FB2-B	---
	3/8"	2FB3-B	---
3/8"	1/4"	---	3FB2
	3/8"	---	3FB3
	1/2"	---	3FB4
1/2"	3/8"	---	4FB3
	1/2"	---	4FB4

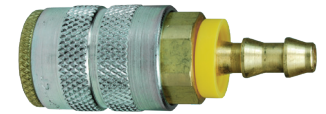

Brass



Steel

E

### Push-Loc Hose Barb Plugs

Body Size	Hose I.D.	Brass Part #	Steel Part #
1/4"	1/4"	D2B2-B	D2B2
	3/8"	---	D2B3
3/8"	1/4"	---	D3B2
	3/4"	---	D3B3
	1/2"	---	D3B4
1/2"	1/2"	---	D4B4
3/4"	3/4"	---	D6B6



Brass

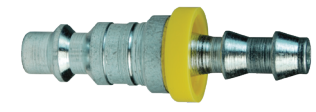

Steel

### Automatic Reusable Barb Couplers

Body Size	Hose I.D. X O.D.	Brass Part #
1/4"	1/4" x 1/2"	2DE2-B
	1/4" x 5/8"	2DH2-B
	3/8" x 11/16"	2DK3-B
	3/8" x 3/4"	2DL3-B



### Reusable Barb Plugs

Body Size	Hose I.D. X O.D.	Steel Part #
1/4"	1/4" x 1/2"	D2E2
	1/4" x 5/8"	D2H2
	3/8" x 11/16"	D2K3
	3/8" x 3/4"	D2L3



### DF-Series Actual Size Profile Charts

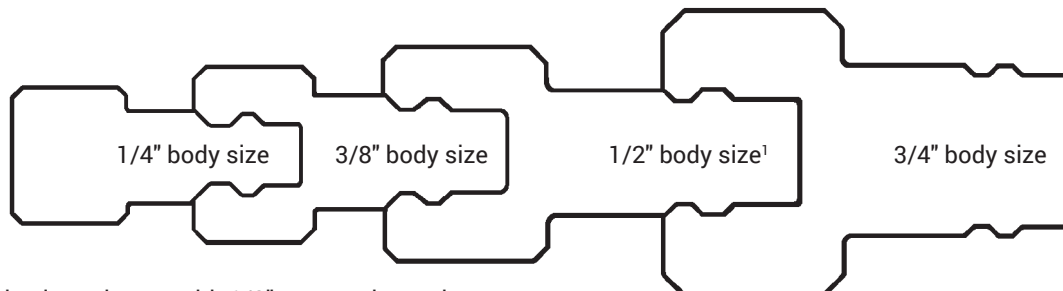

<sup>1</sup> 1/2" may also interchange with 1/2" automotive series

## J-Series Automotive Pneumatic Couplings

### Feature

- Interchanges with other Tru-Flate automotive designs

### Specifications

- Pressure rating: brass coupler/steel plug and steel coupler/steel plug: **500 PSI**, brass coupler/brass plug: **300 PSI**
- Temperature range: **-40°F to 250°F (-40°C to 121°C)**

Operating pressure for couplings utilizing hose barb end connections may be dramatically reduced to that of the hose rating and/or hose end connection combination. Consult hose manufacturer's catalog for hose end connection ratings. In doubt, test under controlled conditions for suitability to application. Dixon® cannot assume liability for misapplication of production resulting in equipment downtime, lost production, and/or personal injury including death.



### Female Threaded Plugs



Brass



Steel

Body Size	Threads	Brass Part #	Steel Part #
1/4"	1/8" - 27 NPTF	---	J2F1
	1/4" - 18 NPTF	J2F2-B	J2F2
	3/8" - 18 NPTF	---	J2F3
3/8"	1/4" - 18 NPTF	---	J3F2
	3/8" - 18 NPTF	---	J3F3
	1/2" - 14 NPTF	---	J3F4
1/2"	3/8" - 18 NPTF	---	J4F3
	1/2" - 14 NPTF	---	J4F4
	3/4" - 14 NPTF	---	J4F6

### Male Threaded Plugs



Brass



Steel

Body Size	Threads	Brass Part #	Steel Part #
1/4"	1/8" - 27 NPTF	---	J2M1
	1/4" - 18 NPTF	J2M2-B	J2M2
	3/8" - 18 NPTF	---	J2M3
3/8"	1/4" - 18 NPTF	---	J3M2
	3/8" - 18 NPTF	---	J3M3
	1/2" - 14 NPTF	---	J3M4
1/2"	3/8" - 18 NPTF	---	J4M3
	1/2" - 14 NPTF	---	J4M4
	3/4" - 14 NPTF	---	J4M6

### Standard Hose Barb Plugs



Body Size	Hose I.D.	Steel Part #
1/4"	1/4"	J2S2
	3/8"	J2S3
3/8"	1/4"	J3S2
	3/8"	J3S3
	1/2"	J3S4
1/2"	3/8"	J4S3
	1/2"	J4S4
	3/4"	J4S6

## J-Series Automotive Pneumatic Couplings

### Female Threaded Couplers

Body Size	Threads	Brass Part #	Steel Part #
1/4"	1/8" - 27 NPTF	2JF1-B	---
	1/4" - 18 NPTF	2JF2-B	---
	3/8" - 18 NPTF	2JF3-B	---
3/8"	1/4" - 18 NPTF	---	3JF2
	3/8" - 18 NPTF	---	3JF3
	1/2" - 14 NPTF	---	3JF4

NOTE: 1/2" body J-Series plugs are used with 1/2" body DF-Series manual couplers on page 198

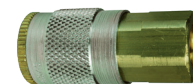

Brass



Steel

### Male Threaded Couplers

Body Size	Threads	Brass Part #	Steel Part #
1/4"	1/8" - 27 NPTF	2JM1-B	---
	1/4" - 18 NPTF	2JM2-B	---
	3/8" - 18 NPTF	2JM3-B	---
3/8"	1/4" - 18 NPTF	---	3JM2
	3/8" - 18 NPTF	---	3JM3
	1/2" - 14 NPTF	---	3JM4

NOTE: 1/2" body J-Series plugs are used with 1/2" body DF-Series manual couplers on page 199

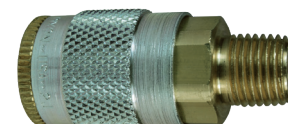

Brass

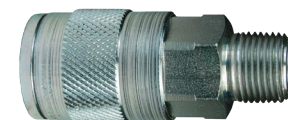

Steel

### Standard Hose Barb Couplers

Body Size	Hose I.D.	Brass Part #	Steel Part #
1/4"	1/4"	2JS2-B	---
	3/8"	2JS3-B	---
3/8"	1/4"	---	3JS2
	3/8"	---	3JS3
	1/2"	---	3JS4

NOTE: 1/2" body J-Series plugs are used with 1/2" body DF-Series manual couplers on page 200



Brass

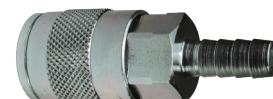

Steel

### Push-Loc Hose Barb Couplers

Body Size	Hose I.D.	Brass Part #	Steel Part #
1/4"	1/4"	2JB2-B	---
	3/8"	2JB3-B	---
3/8"	1/4"	---	3JB2
	3/8"	---	3JB3
	1/2"	---	3JB4

NOTE: 1/2" body J-Series plugs are used with 1/2" body DF-Series manual couplers on page 201

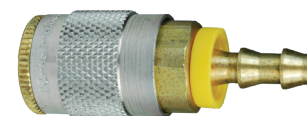

Brass

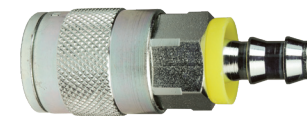

Steel

### Push-Loc Hose Barb Plugs

Body Size	Hose I.D.	Steel Part #
1/4"	1/4"	J2B2
	3/8"	J2B3
3/8"	3/8"	J3B3
1/2"	1/2"	J4B4



## M-Series ARO Pneumatic Couplings

### Features

- Automatic couplings interchange with ARO 210/310 designs and Hansen Series 210/310
- Manual couplings interchange with Parker 50-Series and Amflo Type 'B'

### Specification

- Pressure rating: **300 PSI** at ambient temperature **70°F (21°C)**
- Temperature range: **-40°F to 250°F (-40°C to 121°C)**

It is important to be safe when installing quick disconnect couplings into a pneumatic circuit. Never install a pneumatic coupling directly into an air tool. Use a piece of hose that is at least 18" long, between the tool and the coupling, to prevent damage to the coupling. To protect the operator, safety devices, such as a safety check valve and safety cable should be installed in case there is a hose or coupling failure. For safety check valves and cables see pages 261, 270, and 910. 

### Female Threaded Plugs

Body Size	Threads	Brass Part #	Steel Part #
1/4"	1/4" - 18 NPTF	M2F2-B	M2F2
	3/8" - 18 NPTF	---	M2F3
3/8"	3/8" - 18 NPTF	---	M3F3

### Male Threaded Plugs

Body Size	Threads	Brass Part #	Steel Part #
1/4"	1/8" - 27 NPTF	---	M2M1
	1/4" - 18 NPTF	M2M2-B	M2M2
	3/8" - 18 NPTF	---	M2M3
3/8"	3/8" - 18 NPTF	---	M3M3

### Standard Hose Barb Plugs

Body Size	Hose I.D.	Steel Part #
1/4"	1/4"	M2S2
	3/8"	M2S3
3/8"	3/8"	M3S3

### Automatic Female Threaded Couplers

Body Size	Threads	Steel / Brass Part #
1/4"	1/4" - 18 NPT	2MF2-PL
	3/8" - 18 NPT	2MF3-PL
3/8"	3/8" - 18 NPT	3MF3-PL

### Manual Female Threaded Couplers

Body Size	Threads	Brass Part #
1/4"	1/4" - 18 NPT	2MF2-B
	3/8" - 18 NPT	2MF3-B



Brass

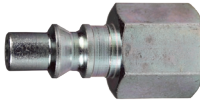

Steel



Brass



Steel



## M-Series ARO Pneumatic Couplings

### Automatic Male Threaded Couplers

Body Size	Threads	Steel / Brass Part #
1/4"	1/4" - 18 NPT	2MM2-PL
	3/8" - 18 NPT	2MM3-PL
3/8"	3/8" - 18 NPT	3MM3-PL
	1/2" - 14 NPTF	3MM4-PL



E

### Manual Male Threaded Couplers

Body Size	Threads	Brass Part #
1/4"	1/4" - 18 NPT	2MM2-B
	3/8" - 18 NPT	2MM3-B



### Automatic Standard Hose Barb Couplers

Body Size	Hose I.D.	Steel / Brass Part #
1/4"	1/4"	2MS2-PL
	5/16"	2MS2.5-PL
	3/8"	2MS3-PL
3/8"	3/8"	3MS3-PL



### Manual Standard Hose Barb Couplers

Body Size	Hose I.D.	Brass Part #
1/4"	1/4"	2MS2-B
	3/8"	2MS3-B



### Push-Loc Barb Plug

Body Size	Hose I.D.	Steel Part #
1/4"	1/4"	M2B2



## CJ-Series Pneumatic Couplings

### Features

- European high-flow interchange
- 1/4" interchanges with Coilhose Megaflo, CEJN 320, and Rectus 25KA/26KA;
- 3/8" interchanges with Rectus 27KA and CEJN 410

### Specifications

- Pressure rating: 300 PSI
- Temperature range: -40°F to 250°F (-40°C to 112°C)

### Female Threaded Plugs

Body Size	Threads	Brass Part #	Steel Part #
1/4"	1/4" - 18 NPT	CJ2F2-B	CJ2F2-LG
	1/4" - 19 BSPP	CJ2BF2-B	CJ2BF2-LG
	3/8" - 18 NPT	CJ2F3-B	CJ2F3-LG
	3/8" - 19 BSPP	CJ2BF3-B	CJ2BF3-LG
3/8"	3/8" - 18 NPT	CJ3F3-B	CJ3F3
	3/8" - 19 BSPP	CJ3BF3-B	CJ3BF3
	1/2" - 14 NPT	CJ3F4-B	---
	1/2" - 14 BSPP	CJ3BF4-B	CJ3BF4

### Male Threaded Plugs

Body Size	Threads	Brass Part #	Steel Part #
1/4"	1/4" - 18 NPT	CJ2M2-B	CJ2M2-LG
	1/4" - 19 BSPT	CJ2BM2-B	CJ2BM2-LG
	3/8" - 18 NPT	CJ2M3-B	CJ2M3-LG
	3/8" - 19 BSPT	CJ2BM3-B	CJ2BM3-LG
3/8"	3/8" - 18 NPT	CJ3M3-B	CJ3M3
	3/8" - 19 BSPT	CJ3BM3-B	CJ3BM3
	1/2" - 14 NPT	CJ3M4-B	CJ3M4
	1/2" - 14 BSPT	CJ3BM4-B	CJ3BM4

### Female Threaded Couplers

Body Size	Threads	Brass Part #
1/4"	1/4" - 18 NPT	2CJF2-B
	1/4" - 19 BSPP	2CJBF2-B
	3/8" - 18 NPT	2CJF3-B
	3/8" - 19 BSPP	2CJBF3-B
3/8"	3/8" - 18 NPT	3CJF3-B
	3/8" - 19 BSPP	3CJBF3-B
	1/2" - 14 NPT	3CJF4-B
	1/2" - 14 BSPP	3CJBF4-B

### Male Threaded Couplers

Body Size	Threads	Brass Part #
1/4"	1/4" - 18 NPT	2CJM2-B
	1/4" - 19 BSPT	2CJBM2-B
	3/8" - 18 NPT	2CJM3-B
	3/8" - 19 BSPT	2CJBM3-B
3/8"	3/8" - 18 NPT	3CJM3-B
	3/8" - 19 BSPT	3CJBM3-B
	1/2" - 14 NPT	3CJM4-B
	1/2" - 14 BSPT	3CJBM4-B

E



Brass

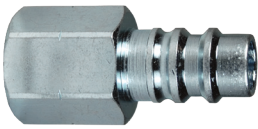

Steel



Brass



Steel

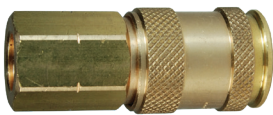



## SHD-Series Schrader Pneumatic Couplings

### Feature

- Interchanges with Parker Twist-Lock, Tomco Series-TL, Foster SHD

### Specifications

- Pressure rating: **300 PSI**
- Temperature range: **-40°F to 250°F (-40°C to 112°C)**

Operating pressure for couplings utilizing hose barb end connections may be dramatically reduced to that of the hose rating and/or hose end connection combination. Consult hose manufacturer's catalog for hose end connection ratings. If in doubt, test under controlled conditions for suitability to application. Dixon Quick Coupling cannot assume liability for misapplication of production resulting in equipment downtime, lost production, and/or personal injury including death.



**E**

### Female Threaded Plugs

Body Size	Threads	Steel Part #
1/4"	1/8" - 27 NPT	SHD2F1
	1/4" - 18 NPT	SHD2F2
1/2"	3/8" - 18 NPT	SHD4F3



### Male Threaded Plugs

Body Size	Threads	Steel Part #
1/4"	1/8" - 27 NPT	SHD2M1
	1/4" - 18 NPT	SHD2M2
1/2"	3/8" - 18 NPT	SHD4M3
	1/2" - 14 NPT	SHD4M4



### Female Threaded Couplers

Body Size	Threads	Aluminum Part #
1/4"	1/4" - 18 NPT	2SHDF2
	3/8" - 18 NPT	2SHDF3
1/2"	3/8" - 18 NPT	4SHDF3
	1/2" - 14 NPT	4SHDF4
	3/4" - 14 NPT	4SHDF6



### Male Threaded Couplers

Body Size	Threads	Aluminum Part #
1/4"	1/4" - 18 NPT	2SHDM2
	3/8" - 18 NPT	2SHDM3
1/2"	3/8" - 18 NPT	4SHDM3
	1/2" - 14 NPT	4SHDM4

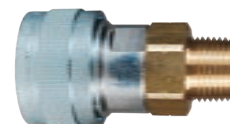

## SHD-Series Schrader Pneumatic Couplings

### Standard Hose Barb Plugs



Body Size	Hose I.D.	Steel Part #
1/4"	1/4"	SHD2S2
	3/8"	SHD2S3
1/2"	3/8"	SHD4S3
	1/2"	SHD4S4

### Standard Hose Barb Couplers



Body Size	Hose I.D.	Aluminum Part #
1/4"	1/4"	2SHDS2
	3/8"	2SHDS3
1/2"	3/8"	4SHDS3
	1/2"	4SHDS4

## L-Series Lincoln Pneumatic Couplings

### Features

- Lincoln Long-Nose Automotive Interchange
- Interchanges with Parker 70-Series, Tomco Series-1110, Coilhose Type-17

### Specifications

- Pressure rating: 300 PSI
- Temperature range: -40°F to 250°F (-40°C to 112°C)

It is important to be safe when installing quick disconnect couplings into a pneumatic circuit. Never install a pneumatic coupling directly into an air tool, use a piece of hose that is at least 18" long, between the tool and the coupling, to prevent damage to the coupling. To protect the operator, safety devices, such as a safety check valve and safety cable should be installed in case there is a hose or coupling failure. For safety check valves and cables see pages 270 and 910. 

### Female Threaded Plug



Body Size	Threads	Steel Part #
1/4"	1/4" - 18 NPT	L2F2

### Male Threaded Plug



Body Size	Threads	Steel Part #
1/4"	1/4" - 18 NPT	L2M2

### Female Threaded Coupler



Body Size	Threads	Brass Part #
1/4"	1/4" - 18 NPT	2LF2-B

### Male Threaded Coupler

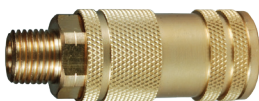

Body Size	Threads	Brass Part #
1/4"	1/4" - 18 NPT	2LM2-B

## U-Series Universal Pneumatic Couplings

### Features

- Couplers are automatic
- 2U-Series 6-in-1 (ARO 210, Industrial, Tru-Flate, Lincoln, Italian, and CEJN 320)
- 3U-Series 4-in-1 (ARO 310, Industrial, Tru-Flate, and CEJN 410)
- Parker UC-Series, Hansen Auto-Flo 23, and Tomco Series UC
- Although the universal coupler permits multiple series nipples to mate with one coupler, it is recommended to match like series couplers and nipples, when using a universal coupler, the lower performance rating between the coupler and nipple must take precedence
- Some pneumatic applications require the pressurized air to be 'dried' to ensure proper operation of equipment and/or application of product (i.e. auto body shops), it is best to match like series couplers and nipples in these applications, if it is necessary to use a universal coupler, lube the seal and valve area regularly to ensure reliable service
- For air service only 

### Specification

- Temperature range: -40°F to 250°F (-40°C to 112°C)

### Female Threaded Couplers

Body Size	Threads	Brass Part #
1/4"	1/4" - 18 NPT	2UF2-B
	1/4"-19 BSPP	2UBF2-B
	3/8" - 18 NPT	2UF3-B
	3/8"-19 BSPP	2UBF3-B
3/8"	3/8" - 18 NPT	3UF3-B
	3/8"-19 BSPP	3UBF3-B



### Male Threaded Couplers

Body Size	Threads	Brass Part #
1/4"	1/4" - 18 NPT	2UM2-B
	1/4"-19 BSPP	2UBM2-B
	3/8" - 18 NPT	2UM3-B
	3/8"-19 BSPP	2UBM3-B
3/8"	3/8" - 18 NPT	3UM3-B
	3/8"-19 BSPP	3UBM3-B



### Standard Hose Barb Couplers

Body Size	Hose I.D.	Brass Part #
1/4"	1/4"	2US2-B
	3/8"	2US3-B
3/8"	3/8"	3US3-B



### Push-On Hose Barb Couplers

Body Size	Hose I.D.	Brass Part #
1/4"	1/4"	2UB2-B
	3/8"	2UB3-B



## NK-Series Japanese Pneumatic Couplings

### Features

- Japanese Industrial Interchange Pneumatic Coupling
- Interchanges with Nitto Kohki Hi-Cupla 200, Rectus Series 13, and CEJN Series 315

### Specifications

- Nitrile rubber seals are standard temperature range **-40°F to 250°F (-40°C to 121°C)**
- Pressure rating: **300 PSI**

### Female Threaded Plugs



Body Size	Threads	Steel Part #
1/4"	1/4" - 18 NPT	NK2F2
	1/4" -19 BSPP	NK2BF2

### Male Threaded Plugs



Body Size	Threads	Steel Part #
1/4"	1/4" - 18 NPT	NK2M2
	1/4" -19 BSPP	NK2BM2

### Hose Barb Plug



Body Size	Hose I.D.	Steel Part #
1/4"	1/4"	NK2S2

### Female Threaded Couplers



Body Size	Threads	Steel Part #
1/4"	1/4" - 18 NPT	2NKF2
	1/4" -19 BSPP	2NKBF2

### Male Threaded Couplers



Body Size	Threads	Steel Part #
1/4"	1/4" - 18 NPT	2NKM2
	1/4" -19 BSPP	2NKBM2

### Hose Barb Coupler



Body Size	Hose I.D.	Steel Part #
1/4"	1/4"	2NKS2

E

## BR-Series Pneumatic Couplings

### Features

- Interchange data: Rectus 21KA, Tomco Series SC, CEJN Series 223

### Specifications

- Nitrile rubber seals are standard temperature range **-40°F to 250°F (-40°C to 121°C)**
- Pressure rating: **300 PSI**

#### Female Threaded Plugs

Body Size	Threads	Brass Part #
1/8"	1/8" - 27 NPT	BR1F1-B-E-7
	1/8" - 28 BSPP	BR1BF1-B-E-7
	1/4" - 18 NPT	BR1F2-B-E-7
	1/4" - 19 BSPP	BR1BF2-B-E-7



**E**

#### Male Threaded Plugs

Body Size	Threads	Brass Part #
1/8"	1/8" - 27 NPT	BR1M1-B-E-7
	1/8" - 28 BSPP	BR1GM1-B-E-7
	1/4" - 18 NPT	BR1M2-B-E-7
	1/4" - 19 BSPP	BR1GM2-B-E-7



#### Female Threaded Couplers

Body Size	Threads	Brass Part #
1/8"	1/8" - 27 NPT	1BRF1-B-7
	1/8" - 28 BSPP	1BRBF1-B-7
	1/4" - 18 NPT	1BRF2-B-7
	1/4" - 19 BSPP	1BRBF2-B-7



#### Male Threaded Couplers

Body Size	Threads	Brass Part #
1/8"	1/8" - 27 NPT	1BRM1-B-7
	1/8" - 28 BSPP	1BRGM1-B-7
	1/4" - 18 NPT	1BRM2-B-7
	1/4" - 19 BSPP	1BRGM2-B-7



#### Hose Barb Plugs

Body Size	Hose I.D.	Brass Part #
1/8"	4mm	BR1S1.25-B-E-7
	6mm	BR1S1.86-B-E-7
	9mm	BR1S2.83-B-E-7

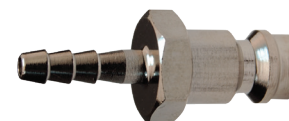

#### Hose Barb Couplers

Body Size	Hose I.D.	Brass Part #
1/8"	4mm	1BRS1.25-B-7
	6mm	1BRS1.86-B-7
	9mm	1BRS2.83-B-7



## A-Series Pneumatic Couplings

**Feature**

- Interchange data: Dixon Quick Coupling Proprietary Astronautics

**Specification**

- Nitrile rubber seals are standard temperature range -40°F to 250°F (-40°C to 121°C)

### Female Threaded Plugs

Body Size	Threads	Brass Part #	Steel Part #
1/8"	1/8" - 27 NPTF	A1F1-B	---
1/4"	1/8" - 27 NPTF	A2F1-B	---
	1/4" - 18 NPTF	A2F2-B	A2F2

### Male Threaded Plugs

Body Size	Threads	Brass Part #	Steel Part #
1/8"	1/8" - 27 NPTF	A1M1-B	---
1/4"	1/4" - 18 NPTF	A2M2-B	A2M2

### Hose Barb Plugs

Body Size	Hose I.D.	Brass Part #	Steel Part #
1/8"	1/8"	A1S1-B	---
1/4"	1/4"	---	A2S2

### Female Threaded Couplers

Body Size	Threads	Brass Part #
1/8"	1/8" - 27 NPTF	1AF1-B
1/4"	1/8" - 27 NPTF	2AF1-B
	1/4" - 18 NPTF	2AF2-B

### Male Threaded Couplers

Body Size	Threads	Brass Part #
1/8"	1/8" - 27 NPTF	1AM1-B
1/4"	1/8" - 27 NPTF	2AM1-B
	1/4" - 18 NPTF	2AM2-B



Brass

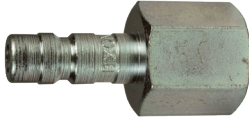

Steel



Brass



Steel



Brass



Steel



E

## A-Series Pneumatic Couplings

### Hose Barb Couplers

Body Size	Hose I.D.	Brass Part #
1/8"	1/8"	1AS1-B
1/4"	1/4"	2AS2-B



### Reusable Barb Plugs

Body Size	Hose I.D.	Brass Part #	Steel Part #
1/4"	1/4" x 1/2"	A2E2-B	A2E2



Brass



Steel

### Reusable Barb Coupler

Body Size	Hose I.D. x O.D.	Brass Part #
1/4"	1/4" x 1/2"	2AE2-B



E

Actual Size Profile Chart

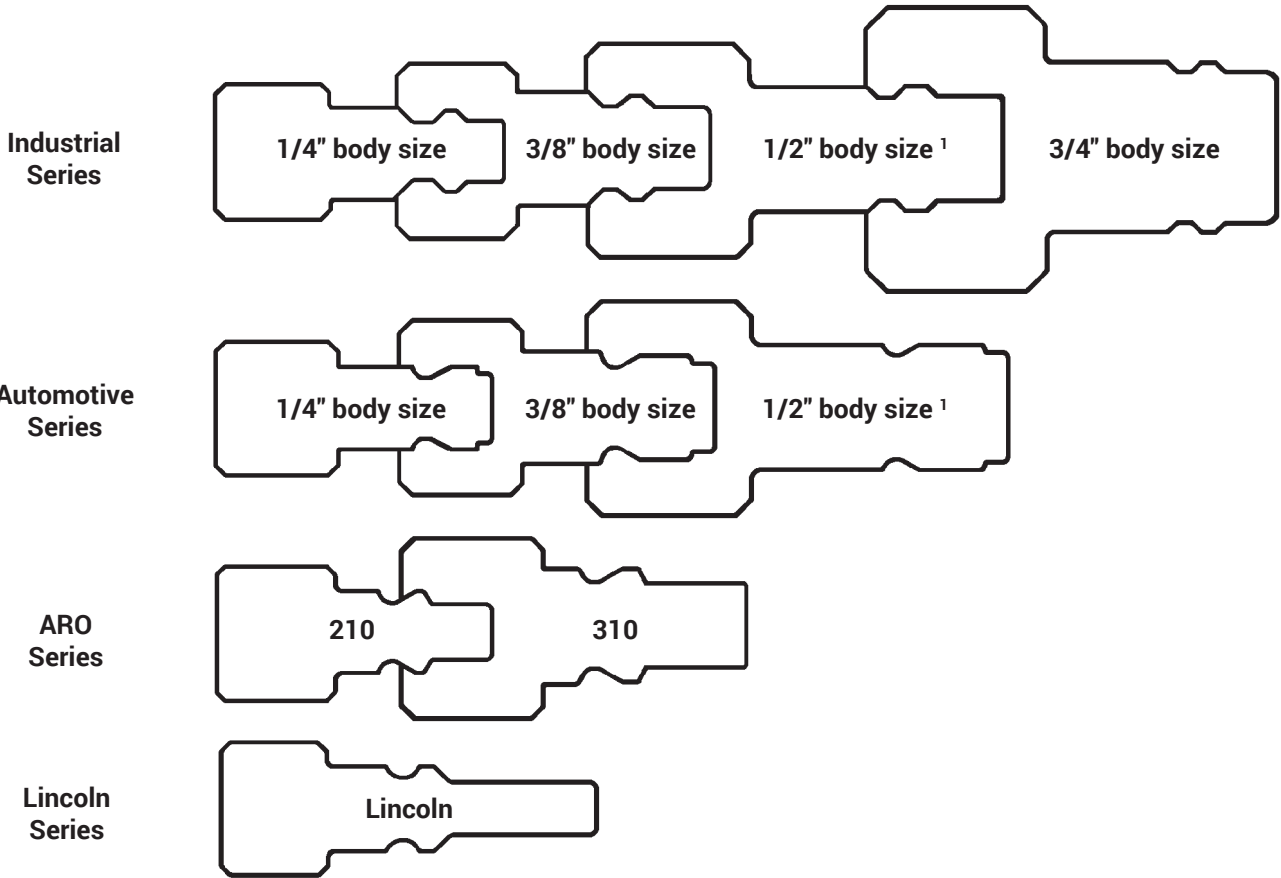

<sup>1</sup> 1/2" industrial series may also interchange with 1/2" automotive series

**Ball Swivel Plug**

**Materials**

- Threaded portion is brass
- Plug and nut portion is nickel-plated hardened steel

**Specification**

- Pressure rating: 250 PSI

**Industrial Ball Swivel Plug**

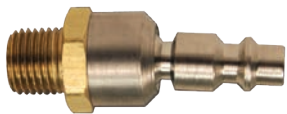

Body Size	Male NPT	Part #
1/4"	1/4"	DCP21SWIV

**Automotive Ball Swivel Plug**



Body Size	Male NPT	Steel Part #
1/4"	1/4"	DCP1SWIV

**ARO Ball Swivel Plug**

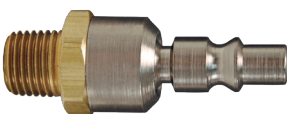

Body Size	Male NPT	Part #
1/4"	1/4"	DCP37SWIV



## Air Chief Industrial Interchange Couplings

### Features

- Interchanges with many other manufacturer's designs
- Interchanges with MIL Spec. MIL-C-4109F/A-A-59439
- For air service only



### Specifications

- Pressure rating: **300 PSI**
- Temperature range: **-40°F to 250°F (-40°C to 121°C)**

### Female Threaded Plugs

Body Size	Female NPT	Flow Rating at 100 PSI	Steel Part #
1/4"	1/8"	37 CFM	DCP2021
	1/4"	37 CFM	DCP20
	3/8"	37 CFM	DCP2023
3/8"	1/4"	70 CFM	DCP2622
	3/8"	70 CFM	DCP26
	1/2"	70 CFM	DCP2624
1/2"	3/8"	150 CFM	DCP1823
	1/2"	150 CFM	DCP18
	3/4"	150 CFM	DCP1826
3/4"	1/2"	200 CFM	DCP7024
	3/4"	200 CFM	DCP7026
	1"	200 CFM	DCP7028



### Male Threaded Plugs

Body Size	Male NPT	Flow Rating at 100 PSI	Steel Part #
1/4"	1/8"	37 CFM	DCP2101
	1/4"	37 CFM	DCP21
	3/8"	37 CFM	DCP2103
3/8"	1/4"	70 CFM	DCP2502
	3/8"	70 CFM	DCP25
	1/2"	70 CFM	DCP2504
1/2"	3/8"	150 CFM	DCP1703
	1/2"	150 CFM	DCP17
	3/4"	150 CFM	DCP1706
3/4"	1/2"	200 CFM	DCP7104
	3/4"	200 CFM	DCP7106
	1"	200 CFM	DCP7108



E

## Air Chief Industrial Interchange Couplings

**Features**

- Interchanges with many other manufacturer’s designs
- Interchanges with MIL Spec. MIL-C-4109F/A-A-59439
- For air service only 

**Specifications**

- Pressure rating: **300 PSI**
- Temperature range: **-40°F to 250°F (-40°C to 121°C)**

E



DCP7145

### Standard Hose Barb Plugs

Body Size	Hose I.D.	Flow Rating at 100 PSI	Steel Part #
1/4"	5/16"	37 CFM	DCP2143
	3/8"	37 CFM	DCP2144
3/8"	1/2"	70 CFM	DCP2545
1/2"	3/4"	150 CFM	DCP1746
3/4"	1/2"	200 CFM	DCP7145
	3/4"	200 CFM	DCP7146
	1"	200 CFM	DCP7148

### Push-On Hose Barb Plugs

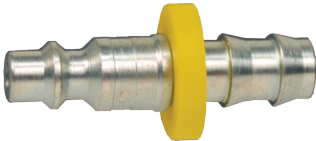

Body Size	Hose I.D.	Flow Rating at 100 PSI	Steel Part #
1/4"	3/8"	37 CFM	DCP2144L
3/8"	1/4"	70 CFM	DCP2542L

## Air Chief Industrial Interchange Couplings

**Features**

- Couplers shut off when disconnected
- Couplers are semi-automatic
- Interchanges with many other manufacturer's designs
- Interchanges with MIL Spec. MIL-C-4109F/A-A-59439
- For air service only

**Specifications**

- Pressure rating: **300 PSI**
- Temperature range: **-40°F to 250°F (-40°C to 121°C)**

E

### Semi-Automatic Female Threaded Couplers

Body Size	Female NPT	Flow Rating at 100 PSI	Brass Part #	Steel Part #
1/4"	1/8"	37 CFM	DC2021	---
	1/4"	37 CFM	DC20	---
	3/8"	37 CFM	DC2023	---
3/8"	1/4"	70 CFM	---	DC2622
	3/8"	70 CFM	---	DC26
	1/2"	70 CFM	---	DC2624
1/2"	3/8"	150 CFM	---	DC1023
	1/2"	150 CFM	---	DC10
	3/4"	150 CFM	---	DC1026

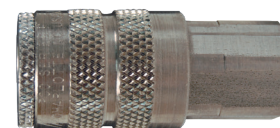

### Male Threaded Couplers

Body Size	Male NPT	Flow Rating at 100 PSI	Brass Part #	Steel Part #
1/4"	1/8"	37 CFM	DC2101	---
	1/4"	37 CFM	DC21	---
	3/8"	37 CFM	DC2103	---
3/8"	1/4"	70 CFM	---	DC2502
	3/8"	70 CFM	---	DC25
	1/2"	70 CFM	---	DC2504
1/2"	3/8"	150 CFM	---	DC903
	1/2"	150 CFM	---	DC9
	3/4"	150 CFM	---	DC906

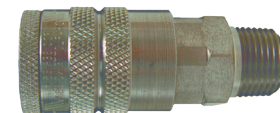

### Standard Hose Barb Couplers

Body Size	Hose I.D.	Flow Rating at 100 PSI	Brass Part #	Steel Part #
1/4"	1/4"	37 CFM	DC2042	---
	5/16"	37 CFM	DC2043	---
	3/8"	37 CFM	DC2044	---
3/8"	3/8"	70 CFM	---	DC2644
	1/2"	70 CFM	---	DC2645
1/2"	3/8"	150 CFM	---	DC1044
	1/2"	150 CFM	---	DC1045
	3/4"	150 CFM	---	DC1046



### Push-On Hose Barb Couplers

Body Size	Hose I.D.	Flow Rating at 100 PSI	Brass Part #	Steel Part #
1/4"	1/4"	37 CFM	DC2042L	---
	3/8"	37 CFM	DC2044L	---
3/8"	1/4"	70 CFM	---	DC2642L
	3/8"	70 CFM	---	DC2644L

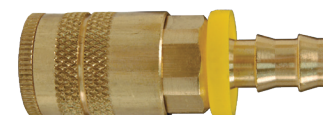

## Air Chief Industrial Interchange Couplings

### Features

- Couplers shut off when disconnected
- Couplers are automatic
- Interchanges with many other manufacturer's designs
- Interchanges with MIL Spec. MIL-C-4109F/A-A-59439
- For air service only 

### Specifications

- Pressure rating: 300 PSI
- Temperature range: -40°F to 250°F (-40°C to 121°C)

### Automatic

#### Female Threaded Couplers



Body Size	Female NPT	Flow Rating at 100 PSI	Brass Part #
3/4"	1/2"	200 CFM	DC7024
	3/4"	200 CFM	DC7026
	1"	200 CFM	DC7028

#### Male Threaded Couplers



Body Size	Male NPT	Flow Rating at 100 PSI	Brass Part #
3/4"	1/2"	200 CFM	DC7104
	3/4"	200 CFM	DC7106
	1"	200 CFM	DC7108

#### Standard Hose Barb Couplers

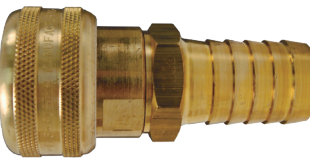

Body Size	Hose I.D.	Flow Rating at 100 PSI	Brass Part #
3/4"	1/2"	200 CFM	DC7045
	3/4"	200 CFM	DC7046
	1"	200 CFM	DC7048

E

## Parker E-z-mate Industrial Couplings

E-z-mate couplings combine push-to-connect, exhaust-style action with a self-locking valve sleeve to guard against accidental disconnection. Simply follow the direction of the on-off arrow stamped on the yellow chromate valve sleeve. Valve sleeve acts as an integral shut off valve that allows connection and disconnection at zero pressure. When the sleeve is moved to shut off air flow, it automatically vents downstream allowing for disconnection at zero pressure and eliminating the risk of hose whip.

### Features

- Meets ISO 4414 requirements for a controlled pressure release system
- Not recommended for vacuum service



### Specifications

- Pressure rating: **300 PSI**
- Temperature range (standard seals): **-40°F to 250°F (-40°C to 121°C)**

**E**

### Female Threaded Couplers

Body Size	Female NPT	Flow Rating at 100 PSI	Steel Part #
1/4"	1/4"-18	37 CFM	DC20SE
	3/8"-18	37 CFM	DC2023SE
3/8"	3/8"-18	70 CFM	DC26SE
	1/2"-14	70 CFM	DC2624SE
1/2"	1/2"-14	150 CFM	DC10SE
	3/4"-14	150 CFM	DC1026SE
3/4"	3/4"-14	200 CFM	DC7026SE
	1"-11-1/2	200 CFM	DC7028SE



### Male Threaded Couplers

Body Size	Male NPT	Flow Rating at 100 PSI	Steel Part #
1/4"	1/4"-18	37 CFM	DC21SE
	3/8"-18	37 CFM	DC2103SE
3/8"	3/8"-18	70 CFM	DC25SE
1/2"	1/2"-14	150 CFM	DC9SE
3/4"	3/4"-14	200 CFM	DC7106SE



### Standard Hose Barb Couplers

Body Size	Hose I.D.	Flow Rating at 100 PSI	Steel Part #
1/4"	1/4"	37 CFM	DC2042SE
	3/8"	37 CFM	DC2044SE
3/8"	3/8"	70 CFM	DC2644SE
1/2"	1/2"	150 CFM	DC1045SE



### Push-Lock Hose Barb Couplers

Body Size	Hose I.D.	Flow Rating at 100 PSI	Steel Part #
1/4"	1/4"	37 CFM	DC2042LSE
	3/8"	37 CFM	DC2044LSE
3/8"	3/8"	70 CFM	DC2644LSE
1/2"	1/2"	150 CFM	DC1045LSE



## Legris Industrial Interchange Safety Couplers

### Applications

- Suited for numerous installations including: pneumatic tools, blow guns, pneumatic automotive equipment

### Features

- Composite, non-marring body
- 1/4" body size ensures excellent flow and total security due to disconnection in two steps
- Compatible with industrial interchange plugs

### Specifications

- Temperature range: -4°F to 140°F (-40°C to 121°C)
- Working pressure: 230 PSI



1. vents plug side



2. disconnects

### Female Threaded Automatic Couplers



Body Size	NPT Size	Part #
1/4"	1/4"	9415U0614
	3/8"	9415U0618

### Male Threaded Automatic Couplers



Body Size	NPT Size	Part #
1/4"	1/4"	9405U0614
	3/8"	9405U0618

## Air Chief Automotive Interchange Couplings

**Features**

- Couplers are semi-automatic
- Interchange with popular makes of automotive quick-connect fittings such as Amflo, Dill, Milton, and Tru-Flate, some designs do not interchange with others, if you plan to interchange these couplings, make sure you have plug ends with the proper configuration

**Specifications**

- Pressure rating: **300 PSI**
- Temperature range: **-40°F to 250°F (-40°C to 121°C)**

### Semi-Automatic

#### Female Threaded Plugs

Body Size	Female NPT	Flow Rating at 100 PSI	Steel Part #
1/4"	1/8"	37 CFM	DCP221
	1/4"	37 CFM	DCP2
	3/8"	37 CFM	DCP223
3/8"	1/4"	70 CFM	DCP8
	3/8"	70 CFM	DCP6
	1/2"	70 CFM	DCP624



#### Male Threaded Plugs

Body Size	Male NPT	Flow Rating at 100 PSI	Steel Part #
1/4"	1/8"	37 CFM	DCP101
	1/4"	37 CFM	DCP1
	3/8"	37 CFM	DCP103
3/8"	1/4"	70 CFM	DCP7
	3/8"	70 CFM	DCP5



#### Standard Hose Barb Plugs

Body Size	Hose I.D.	Flow Rating at 100 PSI	Steel Part #
1/4"	1/4"	37 CFM	DCP142
	3/8"	37 CFM	DCP144
3/8"	3/8"	37 CFM	DCP544



#### Push-On Hose Barb Plugs

Body Size	Hose I.D.	Flow Rating at 100 PSI	Steel Part #
1/4"	1/4"	37 CFM	DCP142L
	3/8"	37 CFM	DCP144L
3/8"	3/8"	70 CFM	DCP544L

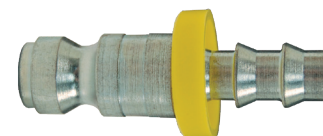

E

## Air Chief Automotive Interchange Couplings

### Features

- Couplers are semi-automatic
- Interchange with popular makes of automotive quick-connect fittings such as Amflo, Dill, Milton, and Tru-Flate, some designs do not interchange with others, if you plan to interchange these couplings, make sure you have plug ends with the proper configuration

### Specifications

- Pressure rating: 300 PSI
- Temperature range: -40°F to 250°F (-40°C to 121°C)

### Semi-Automatic

#### Female Threaded Couplers

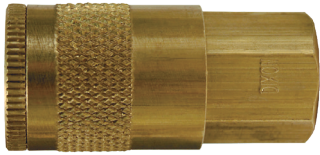

Body Size	Female NPT	Flow Rating at 100 PSI	Brass Part #	Steel Part #
1/4"	1/8"	37 CFM	DC221	---
	1/4"	37 CFM	DC2	---
	3/8"	37 CFM	DC223	---
3/8"	1/4"	70 CFM	---	DC8
	3/8"	70 CFM	---	DC6
	1/2"	70 CFM	---	DC624

#### Male Threaded Couplers

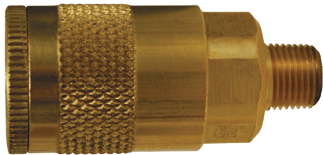

Body Size	Male NPT	Flow Rating at 100 PSI	Brass Part #	Steel Part #
1/4"	1/8"	37 CFM	DC101	---
	1/4"	37 CFM	DC1	---
	3/8"	37 CFM	DC103	---
3/8"	1/4"	70 CFM	---	DC7
	3/8"	70 CFM	---	DC5
	1/2"	70 CFM	---	DC504

#### Standard Hose Barb Couplers

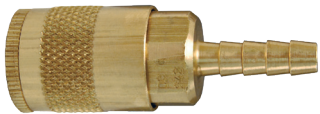

Body Size	Hose I.D.	Flow Rating at 100 PSI	Brass Part #	Steel Part #
1/4"	1/4"	37 CFM	DC242	---
	3/8"	37 CFM	DC244	---
3/8"	3/8"	70 CFM	---	DC644
	1/2"	70 CFM	---	DC645

#### Push-On Hose Barb Couplers

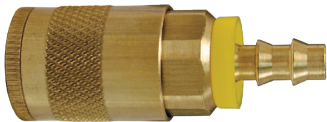

Body Size	Hose I.D.	Flow Rating at 100 PSI	Brass Part #	Steel Part #
1/4"	1/4"	37 CFM	DC242L	---
	3/8"	37 CFM	DC244L	---
3/8"	3/8"	70 CFM	---	DC644L

### Air Chief Automotive Actual Size Profile Charts

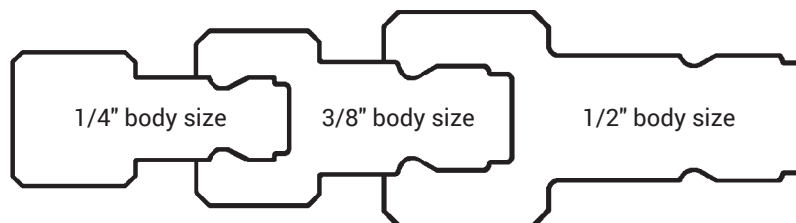

E



## Air Chief ARO Speed Interchange Couplings

**Features**

- Interchanges with ARO 210 and 310 designs
- Couplers shut off when disconnected

**Specification**

- Pressure rating: **300 PSI** at ambient temperature 70°F (21°C)

### Female Threaded Plugs

Body Size	Female NPT	Flow Rating at 100 PSI	Steel Part #
1/4"	1/4"	37 CFM	DCP38
	3/8"	37 CFM	DCP3823
3/8"	3/8"	70 CFM	DCP36



E

### Male Threaded Plugs

Body Size	Male NPT	Flow Rating at 100 PSI	Steel Part #
1/4"	1/4"	37 CFM	DCP37
	3/8"	37 CFM	DCP3703
3/8"	3/8"	70 CFM	DCP35

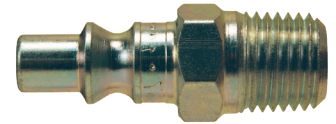

### Standard Hose Barb

Body Size	Hose I.D.	Flow Rating at 100 PSI	Steel Part #
1/4"	1/4"	37 CFM	DCP3742



### Push-On Hose Barbs

Body Size	Hose I.D.	Flow Rating at 100 PSI	Steel Part #
1/4"	1/4"	37 CFM	DCP3742L
	3/8"	37 CFM	DCP3744L

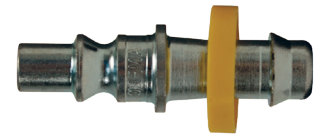

## Air Chief ARO Speed Interchange Couplings

### Semi-Auto Female Threaded Couplers

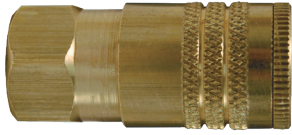

Body Size	Hose I.D.	Flow Rating at 100 PSI	Brass Part #	Steel Part #
1/4"	1/4"	37 CFM	DC38	---
	3/8"	37 CFM	DC3823	---
3/8"	3/8"	70 CFM	---	DC36

E

### Semi-Auto Male Threaded Couplers

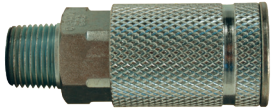

Body Size	Hose I.D.	Flow Rating at 100 PSI	Brass Part #	Steel Part #
1/4"	1/4"	37 CFM	DC37	---
	3/8"	37 CFM	DC3703	---
3/8"	3/8"	70 CFM	---	DC35

### Semi-Auto Standard Hose Barb Couplers

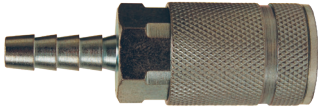

Body Size	Hose I.D.	Flow Rating at 100 PSI	Steel Part #
1/4"	1/4"	37 CFM	DC3842
	3/8"	37 CFM	DC3844

### Semi-Auto Push-On Hose Barb Couplers

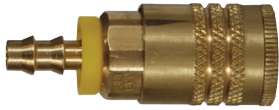

Body Size	Hose I.D.	Flow Rating at 100 PSI	Brass Part #
1/4"	1/4"	37 CFM	DC3842L
	3/8"	37 CFM	DC3844L

### Air Chief ARO Actual Size Profile Charts

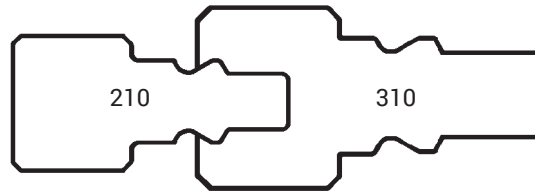

## Air Chief Lincoln Interchange Couplings

### Features

- Interchangeable with the Lincoln Interchange long stem series
- Couplers shut off when disconnected
- Couplers are semi-automatic

### Specification

- Pressure rating: **300 PSI** at ambient temperature 70°F (21°C)

#### Female Threaded Plug

Body Size	Female NPT	Flow Rating at 100 PSI	Steel Part #
1/4"	1/4"	37 CFM	DCP28



E

#### Male Threaded Plug

Body Size	Male NPT	Flow Rating at 100 PSI	Steel Part #
1/4"	1/4"	37 CFM	DCP27



#### Female Threaded Coupler

Body Size	Female NPT	Flow Rating at 100 PSI	Brass Part #
1/4"	1/4"	37 CFM	DC28

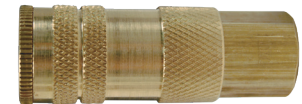

#### Male Threaded Coupler

Body Size	Female NPT	Flow Rating at 100 PSI	Brass Part #
1/4"	1/4"	37 CFM	DC27

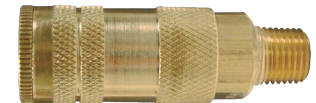

### Air Chief Lincoln Actual Size Profile Chart

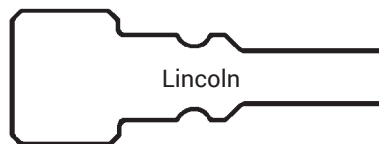

### 3500 Male Nipples

**Features**

- For air and water service only
- The constant vibration created by air tools, like air drills and pavement breakers, is destructive to air hose couplings, especially the quick-acting type; to provide protection against coupling breakage and related hazards, Dixon® recommends the use of a whip hose; to construct a whip hose, connect one end of a short (3' to 10') air hose to the air tool using a 3500 type steel nipple; connect the other end of the hose to the air supply using the standard quick-acting coupling; the heat-treated 3500 nipple will withstand vibration far better than the standard coupling and provide a safer connection; the whip hose should remain permanently connected to the tool.

**Specification**

- Working pressure: **600 PSI** at ambient temperature **70°F (21°C)**

**Male Threaded**

Hose Size	Male NPT	Zinc Plated Steel Part #	Optional Qty
1/4"	1/8"	3501	100
	1/4"	3502	100
	3/8"	3504	100
3/8"	1/4"	3505	100
	3/8"	3506	100
	1/2"	3508	100
1/2"	1/4"	3509	100
	3/8"	3510	100
	1/2"	3512	100
3/4"	3/4"	3511	50
	1/2"	3513	50
	3/4"	3514	50
1"	1"	3515	25
	3/4"	3516	25
	1"	3518	25

**Female Threaded**

Hose Size	Female NPT	Zinc Plated Steel Part #	Optional Qty
1/4"	1/4"	3542	100
3/8"	1/4"	3545	50
	3/8"	3546	50
1/2"	3/8"	3550	100
	1/2"	3552	50
3/4"	3/4"	3554	50

**Male Threaded with Ferrule**

**Features**

- Zinc plated steel 3500 nipple with carbon steel ferrule
- Can be crimped or swaged-on to achieve maximum coupling sealing and retention; for crimp dimensions see [dixonvalve.com](http://dixonvalve.com)
- Low-profile, streamline appearance

Hose Size	Male NPT	Hose O.D.		Steel Part #
		From	To	
3/8"	1/4"	46/64"	50/64"	3505WF
	1/2"	46/64"	50/64"	3508WF
1/2"	1/4"	54/64"	58/64"	3509WF
	3/8"	54/64"	58/64"	3510WF
	3/4"	54/64"	58/64"	3511WF
	1/2"	54/64"	58/64"	3512WF
3/4"	3/4"	1-10/64"	1-14/64"	3514WF
1"	1"	1-30/64"	1-34/64"	3518WF
	1"	1-34/64"	1-38/64"	3518WF2

E



## Bent Stem Swivels

### Hose Barb

**Features**

- 7/8" thread fits the following tool brands: Ingersoll-Rand, Thor, Black & Decker, Harper, Jet, Texas Pneumatic, Kent, and Sullair
- 1/2" thread fits all tools with 1/2" female NPT thread
- 1/2" hose barb

**Specification**

- Designed for normal operation at **90 PSI** at ambient temperature **70°F (21°C)**

Description	Steel Part #	Optional Qty
7/8" - 24 thread x 1/2" hose barb	ATS7812H	50
1/2" NPT thread x 1/2" hose barb	ATS1212H	50



E

### Female Pipe Thread

**Features**

- 7/8" thread fits most chipping hammers
- 3/8" female pipe thread

**Specification**

- Designed for normal operation at **90 PSI** at ambient temperature **70°F (21°C)**

Description	Steel Part #	Optional Qty
7/8" - 24 thread x 3/8" female NPT	ATS7838F	25



### Male Pipe Thread

**Features**

- 7/8" thread fits most chipping hammers
- 3/8" male pipe thread

**Specification**

- Designed for normal operation at **90 PSI** at ambient temperature **70°F (21°C)**

Description	Steel Part #	Optional Qty
7/8" - 24 thread x 3/8" male NPT	ATS7838M	50



### D.O.T. Push-In Fittings

**Features**

- Materials:
  - Body (straights) tube, supports and grippers: brass CA360
  - Forged elbows and tees: brass CA377
  - O-ring: nitrile rubber
- Suitable for use up to the maximum working pressure of the plastic tubing used; also suitable for vacuum service
- Pre-applied thread sealant (Loctite 516®) on all male pipe threads
- Compatible tubing: SAE J844

**Specifications**

- Temperature range: -40°F to 212°F (-40°C to 100°C)
- Meets D.O.T. FMVSS 571.106 and SAE J1131, SAE J2494-1, and SAE J2494-3

**Male Connectors**



Tube O.D.	Male NPTF	Part #	Pkg Qty
1/4"	1/8"	AQ68DOT4X2	10
	1/4"	AQ68DOT4X4	10
	3/8"	AQ68DOT4X6	5
3/8"	1/4"	AQ68DOT6X4	10
	3/8"	AQ68DOT6X6	10

**Union Connectors**



Tube O.D.	Part #	Pkg Qty
1/4"	AQ62DOT4	10
3/8"	AQ62DOT6	10

**Male Elbows**



Tube O.D.	Male NPTF	Part #	Pkg Qty
1/4"	1/8"	AQ69DOT4X2	10
	1/4"	AQ69DOT4X4	10
3/8"	1/4"	AQ69DOT6X4	10

**D.O.T. Push-In Male Swivel Elbows**



Tube O.D.	Male NPTF	Part #	Pkg Qty
1/4"	1/8"	AQ69DOTS4X2	10
	1/4"	AQ69DOTS4X4	10
	3/8"	AQ69DOTS4X6	10
3/8"	1/4"	AQ69DOTS6X4	10
	3/8"	AQ69DOTS6X6	5

E

**D.O.T. Push-In Fittings**

**Male Swivel Run Tees**

Tube O.D.	Male NPTF	Part #	Pkg Qty
1/4"	1/8"	AQ71DOTS4X2	10
	1/4"	AQ71DOTS4X4	5



**E**

**Male Swivel Branch Tees**

Tube O.D.	Male NPTF	Part #	Pkg Qty
1/4"	1/8"	AQ72DOTS4X2	10
	1/4"	AQ72DOTS4X4	5



**Union Tees**

Tube O.D.	Part #	Pkg Qty
1/4"	AQ64DOT4	10
3/8"	AQ64DOT6	10



## Legris D.O.T. Push-In Fittings

### Features

- Suitable fluids: compressed air only
- Complies with the performance requirements of D.O.T. FMVSS 571.106 (SAE J1131) and SAE J2494-3
- These fittings are designed for use on all pneumatic circuits other than air brake assemblies between the frame and axle or between towed and towing vehicle 

### Materials

- Composite body, brass collet, stainless steel tube support, brass threads, nitrile rubber O-ring

### Specifications

- Maximum operating pressure: **250 PSI** at ambient temperature **70°F (21°C)**
- Temperature range: **-40°F to 200°F (-40°C to 93°C)**

### Male Connectors

Tube O.D.	Male NPT	Part #	Pkg Qty
5/32"	1/8"	31150411DOT	10
	1/4"	31150414DOT	10
3/16"	1/8"	31155511DOT	10
	1/4"	31155514DOT	10
1/4"	1/8"	31155611DOT	10
	1/4"	31155614DOT	10
	3/8"	31155618DOT	10
3/8"	1/8"	31156011DOT	10
	1/2"	31156014DOT	10
	3/8"	31156018DOT	10
	1/2"	31156022DOT	10
1/2"	1/4"	31156214DOT	10
	3/8"	31156218DOT	10
	1/2"	31156222DOT	10



NOTE: Meets D.O.T. FMVSS571.106, SAE J2494, and SAE J2494-3

### Female Connectors

Tube O.D.	Female NPT	Part #	Pkg Qty
5/32"	1/8"	31140411DOT	10
3/16"	1/8"	31145511DOT	10
1/4"	1/8"	31145611DOT	10
	1/4"	31145614DOT	10
3/8"	1/4"	31146014DOT	10
	3/8"	31146018DOT	10



NOTE: Meets D.O.T. FMVSS571.106, SAE J2494, and SAE J2494-3



## Legris D.O.T. Push-In Fittings

### Unions

Tube O.D.	Part #	Pkg Qty
5/32"	31060400DOT <sup>1,2</sup>	10
3/16"	31065500DOT <sup>1,2</sup>	10
1/4"	31065600DOT <sup>3</sup>	10
3/8"	31066000DOT <sup>3</sup>	10
1/2"	31066200DOT <sup>3</sup>	10

<sup>1</sup> Brass body

<sup>2</sup> Meets D.O.T. FMVSS571.106, SAE J2494, and SAE J2494-3

<sup>3</sup> Meets D.O.T. FMVSS571.106, SAE J1131, and SAE J2494-3



E

### Bulkhead Unions

Tube O.D.	Part #	Pkg Qty
1/4"	31165600DOT	10
3/8"	31166000DOT	10
1/2"	31166200DOT	10

NOTE: Meets D.O.T. FMVSS571.106, SAE J2494, and SAE J2494-3



### Union Elbows

Tube O.D.	Part #	Pkg Qty
5/32"	31020400DOT <sup>1</sup>	10
1/4"	31025600DOT	10
3/8"	31026000DOT	10
1/2"	31026200DOT	10

<sup>1</sup> Brass body

NOTE: 5/32" diameter meets D.O.T. FMVSS571.106, SAE J2494, and SAE J2494-3.

1/4", 3/8", and 1/2" diameters meet D.O.T. FMVSS571.106, SAE J1131, and SAE J2494-3



### Male Elbows

Tube O.D.	Male NPT	Part #	Pkg Qty
5/32"	1/8"	31090411DOT <sup>1</sup>	10
3/16"	1/8"	31095511DOT <sup>1</sup>	10
1/4"	1/8"	31095611DOT	10
	1/4"	31095614DOT	10
	3/8"	31095618DOT	10
	1/4"	31096014DOT	10
3/8"	3/8"	31096018DOT	10
	1/2"	31096022DOT	10
	1/4"	31096214DOT	10
1/2"	3/8"	31096218DOT	10
	1/2"	31096222DOT	10

<sup>1</sup> Brass body

NOTE: 5/32" and 3/16" diameter meets D.O.T. FMVSS571.106, SAE J2494, and SAE J2494-3.

1/4", 3/8", and 1/2" diameters meet D.O.T. FMVSS571.106, SAE J1131, and SAE J2494-3.

Fitting can be oriented 360°, allowing proper positioning of the fitting



**Legris D.O.T. Push-In Fittings**

**Reducer**



Tube O.D.	Tube O.D.	Part #	Pkg Qty
1/4"	3/8"	31665660DOT	10

NOTE: Meets D.O.T. FMVSS571.106, SAE J1131, and SAE J2494-3

**Plug In Elbow**



Tube O.D.	Part #	Pkg Qty
1/4"	31825600DOT	10

NOTE: Meets D.O.T. FMVSS571.106, SAE J1131, and SAE J2494-3

**Male Branch Tees**



Tube O.D.	Male NPT	Part #	Pkg Qty
1/4"	1/8"	31085611DOT	10
	1/4"	31085614DOT	10
	3/8"	31085618DOT	10
3/8"	1/4"	31086014DOT	10
	3/8"	31086018DOT	10
	1/2"	31086022DOT	10
1/2"	1/4"	31086214DOT	10
	3/8"	31086218DOT	10
	1/2"	31086222DOT	10

NOTE: 1/4", 3/8", and 1/2" diameters meet D.O.T. FMVSS571.106, SAE J1131, and SAE J2494-3. Fitting can be oriented 360°, allowing proper positioning of the fitting.

**Union Tees**



Tube O.D.	Part #	Pkg Qty
5/32"	31040400DOT <sup>1</sup>	10
3/16"	31045500DOT <sup>1</sup>	10
1/4"	31045600DOT	10
3/8"	31046000DOT	10
1/2"	31046200DOT	10

<sup>1</sup> Brass body

NOTE: 5/32" and 3/16" diameter meets D.O.T. FMVSS571.106, SAE J2494, and SAE J2494-3.

1/4", 3/8", and 1/2" diameters meet D.O.T. FMVSS571.106, SAE J1131, and SAE J2494-3

E

## Legris D.O.T. Push-In Fittings

### Legris D.O.T. Push-In Male Run Tees

Tube O.D.	Male NPT	Part #	Pkg Qty
3/16"	1/8"	31035511DOT <sup>1</sup>	10
	1/8"	31035611DOT	10
1/4"	1/4"	31035614DOT	10
	3/8"	31035618DOT	10
	1/4"	31036014DOT	10
3/8"	3/8"	31036018DOT	10
	1/2"	31036022DOT	10
	1/4"	31036214DOT	10
1/2"	3/8"	31036218DOT	10
	1/2"	31036222DOT	10



E

<sup>1</sup> Brass body

NOTE: 3/16" diameter meets D.O.T. FMVSS571.106, SAE J2494, and SAE J2494-3.

1/4", 3/8", and 1/2" diameters meet D.O.T. FMVSS571.106, SAE J1131, and SAE J2494-3.  
Fitting can be oriented 360°, allowing proper positioning of the fitting.

### Legris D.O.T. Push-In Plug In Run Tee

Tube O.D.	Part #	Pkg Qty
1/4"	31835600DOT	10



NOTE: Meets D.O.T. FMVSS571.106, SAE J1131, and SAE J2494-3

### Legris D.O.T. Push-In Y Connectors

Tube O.D.	Male NPT	Part #	Pkg Qty
1/4"	1/8"	31485611DOT	10
	1/4"	31485614DOT	10



NOTE: Meets D.O.T. FMVSS571.106, SAE J1131, and SAE J2494-3.

Fitting can be oriented 360°, allowing proper positioning of the fitting.

### Legris D.O.T. Push-In Y Unions

Tube O.D.	Part #	Pkg Qty
1/4"	31405600DOT	10
3/8"	31406000DOT	10



NOTE: Meets D.O.T. FMVSS571.106, SAE J1131, and SAE J2494-3.

### Air Brake Fittings

**Applications**

- Designed for use in air brake systems or cab controls

**Features**

- Utilize ribbed sleeve for compression and positive grip
- Machined from CA360, CA345, or CA377 brass
- Pre-applied thread sealant on all male pipe threads
- Maximum operating pressure: 150 PSI
- Compatible tubing: SAE J844 type A and B
- Specifications: meets D.O.T. FMVSS 571.106 and SAE J246

**Assembly Instructions:**

1. Cut tubing squarely - maximum of 15° angle allowable.
2. Check that port or mating part is clean and free of debris.
3. Insert tubing into fittings until it bottoms on seat.
4. Tighten nut with wrench until one thread remains visible on the fittings body (this will allow for a number of remakes); or, the nut should be screwed down finger tight, then wrench-tightened as indicated in the chart below.

Tube Size	Turns required to seal from hand tight
3/16"	2-1/2
1/4"	3
3/8" & 1/2"	4
5/8" & 3/4"	3-1/2

### Male Connectors

**Features**

- Ref. SAE 100102 BA
- Thread sealant may be white or burnt orange



Tube Size	Pipe Thread	Straight Thread	Part #	Pkg Qty
3/16"	1/16"	5/16"-24	68NAB31VS	25
	1/8"	5/16"-24	68NAB32VS	50
	1/4"	5/16"-24	68NAB34VS	25
1/4"	1/8"	7/16"-24	68NAB42VS	50
	1/4"	7/16"-24	68NAB44VS	50
	3/8"	7/16"-24	68NAB46VS	10
3/8"	1/8"	17/32"-24	68NAB62VS	25
	1/4"	17/32"-24	68NAB64VS	25
	3/8"	17/32"-24	68NAB66VS	25
	1/2"	17/32"-24	68NAB68VS	25
1/2"	1/4"	11/16"-20	68NAB84VS	10
	3/8"	11/16"-20	68NAB86VS	25
	1/2"	11/16"-20	68NAB88VS	25
5/8"	3/8"	13/16"-18	68NAB106VS	10
	1/2"	13/16"-18	68NAB108VS	10
3/4"	3/8"	1"-18	68NAB126VS	10
	1/2"	1"-18	68NAB128VS	10
	3/4"	1"-18	68NAB1212VS	10

### Female Connectors

**Feature**

- Ref. SAE 100103 BA



Tube Size	Pipe Thread	Straight Thread	Part #	Pkg Qty
1/4"	1/8"	7/16"-24	66NAB42	25
	1/4"	7/16"-24	66NAB44	10
3/8"	1/8"	17/32"-24	66NAB62	10
	1/4"	17/32"-24	66NAB64	10
1/2"	3/8"	11/16"-20	66NAB86 <sup>1</sup>	10
	1/2"	11/16"-20	66NAB88	10
5/8"	3/8"	13/16"-18	66NAB106	10
	1/2"	13/16"-18	66NAB108	10

<sup>1</sup> Not full hex as shown

## Air Brake Fittings

### Unions

**Feature**

- Ref. SAE 100101

Tube Size	Straight Thread	Part #	Pkg Qty
1/4"	7/16"-24	62NAB4	10
3/8"	17/32"-24	62NAB6	10
1/2"	11/16"-20	62NAB8	10
5/8"	13/16"-18	62NAB10	10
3/4"	1"-18	62NAB12	10



**E**

### Bulkhead Unions

Tube Size	Straight Thread	Part #	Pkg Qty
1/4"	7/16"-24	62NABH4	10
3/8"	17/32"-24	62NABH6	10
1/2"	11/16"-20	62NABH8	10



### Bulkhead Unions

Tube Size	Straight Thread	Part #	Pkg Qty
3/16"	5/16"-24	62NBH3	10
1/4"	7/16"-24	62NBH4	10
3/8"	17/32"-24	62NBH6	10
1/2"	11/16"-20	62NBH8	10
5/8"	13/16"-18	62NBH10	10



### Bulkhead Unions

Tube Size	Straight Thread	Part #	Pkg Qty
1/4"	7/16"-24	62NFBH4	10
3/8"	17/32"-24	62NFBH6	10
1/2"	11/16"-20	62NFBH8	10
5/8"	13/16"-18	62NFBH10	10



### Bulkhead Unions

Tube Size	Pipe Thread	Part #	Pkg Qty
1/2"	3/8"	66NBH86	10



### Female Elbows

**Feature**

- Ref. SAE 100203 BA

Tube Size	Pipe Thread	Straight Thread	Part #	Pkg Qty
3/16"	1/8"	5/16"-24	70NAB32	25
1/4"	1/8"	7/16"-24	70NAB42	25
	1/4"	7/16"-24	70NAB44	25
3/8"	1/8"	17/32"-24	70NAB62	10
	1/4"	17/32"-24	70NAB64 <sup>1</sup>	10
	3/8"	17/32"-24	70NAB66	10
1/2"	3/8"	11/16"-20	70NAB86	10
	1/2"	11/16"-20	70NAB88	10
5/8"	1/2"	13/16"-18	70NAB108	10



<sup>1</sup> Rounded elbow parts not as pictured

## Air Brake Fittings

### Male Elbows

**Features**

- Ref. SAE 100202 BA
- Thread sealant may be white or burnt orange



Tube Size	Pipe Thread	Straight Thread	Part #	Pkg Qty
3/16"	1/8"	5/16"-24	69NAB32VS	10
	1/4"	5/16"-24	69NAB34VS	10
1/4"	1/8"	7/16"-24	69NAB42VS	50
	1/4"	7/16"-24	69NAB44VS	50
	3/8"	7/16"-24	69NAB46VS	10
3/8"	1/8"	17/32"-24	69NAB62VS	10
	1/4"	17/32"-24	69NAB64VS	25
	3/8"	17/32"-24	69NAB66VS	25
	1/2"	17/32"-24	69NAB68VS	10
1/2"	1/4"	11/16"-20	69NAB84VS	10
	3/8"	11/16"-20	69NAB86VS	10
	1/2"	11/16"-20	69NAB88VS	10
5/8"	3/8"	13/16"-18	69NAB106VS	10
	1/2"	13/16"-18	69NAB108VS	5
3/4"	1/2"	1"-18	69NAB128VS	5
	3/4"	1"-18	69NAB1212VS	5

### Union Elbows

**Feature**

- Ref. SAE 100201 BA



Tube Size	Straight Thread	Part #	Pkg Qty
1/4"	7/16"-24	65NAB4	10
3/8"	17/32"-24	65NAB6	10
1/2"	11/16"-20	65NAB8	10
5/8"	13/16"-18	65NAB10	10

### 45° Elbows

**Features**

- Ref. SAE 100302 BA
- Thread sealant may be white or burnt orange



Tube Size	Pipe Thread	Straight Thread	Part #	Pkg Qty
1/4"	1/8"	7/16"-24	79NAB42VS	10
	1/4"	7/16"-24	79NAB44VS	10
3/8"	1/8"	17/32"-24	79NAB62VS	10
	1/4"	17/32"-24	79NAB64VS	10
	3/8"	17/32"-24	79NAB66VS	10
	1/2"	17/32"-24	79NAB68VS	10
1/2"	1/4"	11/16"-20	79NAB84VS	10
	3/8"	11/16"-20	79NAB86VS	10
	1/2"	11/16"-20	79NAB88VS	10
5/8"	3/8"	13/16"-18	79NAB106VS	5
	1/2"	13/16"-18	79NAB108VS	5
3/4"	1/2"	1"-18	79NAB128VS	2

## Air Brake Fittings

### Male Branch Tees

**Features**

- Ref. SAE 100425 BA
- Thread sealant may be white or burnt orange

Tube Size	Pipe Thread	Straight Thread	Part #	Pkg Qty
3/16"	1/8"	7/16"-24	72NAB32VS	10
1/4"	1/8"	7/16"-24	72NAB42VS	10
	1/4"	7/16"-24	72NAB44VS	10
3/8"	1/8"	17/32"-24	72NAB62VS	10
	1/4"	17/32"-24	72NAB64VS	10
	3/8"	17/32"-24	72NAB66VS	10
1/2"	1/4"	11/16"-20	72NAB84VS	10
	3/8"	11/16"-20	72NAB86VS	10
	1/2"	11/16"-20	72NAB88VS	10
5/8"	1/2"	13/16"-18	72NAB108VS	10



E

### Union Tees

**Feature**

- Ref. SAE 100401 BA

Tube Size	Straight Thread	Part #	Pkg Qty
1/4"	7/16"-24	64NAB4	25
3/8"	17/32"-24	64NAB6	10
1/2"	11/16"-20	64NAB8	10
5/8"	13/16"-18	64NAB10	10



### Male Run Tees

**Features**

- Ref. SAE 100424 BA
- Thread sealant may be white or burnt orange

Tube Size	Pipe Thread	Straight Thread	Part #	Pkg Qty
1/4"	1/8"	7/16"-24	71NAB42VS	10
	1/4"	7/16"-24	71NAB44VS	10
3/8"	1/4"	17/32"-24	71NAB64VS	10
	3/8"	17/32"-24	71NAB66VS	10
1/2"	3/8"	11/16"-20	71NAB86VS	10
	1/2"	11/16"-20	71NAB88VS	10
5/8"	1/2"	13/16"-18	71NAB108VS	5



### Sleeves

**Feature**

- Ref. SAE 100115

Tube Size	Part #	Pkg Qty
3/16"	60NAB3	100
1/4"	60NAB4	100
3/8"	60NAB6	100
1/2"	60NAB8	100
5/8"	60NAB10	10
3/4"	60NAB12	50



**Air Brake Fittings**

**Inserts**

**Feature**

- For SAE J844 tubing



Tube Size	302 / 304 Stainless Steel Part #	Pkg Qty
1/4"	63NAB4	200
3/8"	63NAB6	200
1/2"	63NAB8	100
5/8"	63NAB10	100
3/4"	63NAB12	100

**Nuts**

**Feature**

- Ref. SAE 100110



Tube Size	Male NPT	Part #	Pkg Qty
3/16"	5/16"-24	61NAB3	100
1/4"	7/16"-24	61NAB4	100
3/8"	17/32"-24	61NAB6	100
1/2"	11/16"-20	61NAB8	50
5/8"	13/16"-18	61NAB10	25
3/4"	1"-18	61NAB12	25

**Air Brake Fittings for Rubber Hose**

**Application**

- For use with SAE J1402 air brake hose in making hose assemblies

**Feature**

- Will meet D.O.T. FMVSS 571-106 standards when used with SAE J1402 air brake hose

**Specifications**

- Working pressure: up to 225 PSI
- Temperature: -50°F to 212°F (-46° to 100°C)

**Assembly Guide**

1. Slide nut onto hose
2. Slide sleeve onto hose with tapered edge toward fitting body
3. Firmly bottom the hose into fittings
4. Screw nut onto body until it contacts the fittings body's hex

**Hose Springs**



Hose Size	Length	Brass Alloy 360 Part #
3/8"	2.70"	56RBSG-06
1/2"	2.70"	56RBSG-08

**Spring Guard Nuts**



Hose Size	Straight Thread	Brass Alloy 360 Part #
3/8"	31/32"-20	61RBSG-06
1/2"	1-3/32"-20	61RBSG-08

E



## Air Brake Fittings for Rubber Hose

### Hose Nut with Attached Springs

Hose Size	Length	Brass Alloy 360 Part #
3/8"	3.55"	67RBSG-06
1/2"	3.50"	67RBSG-08



### Male Connectors

Tube O.D.	Pipe Thread	Straight Thread	Hex	Brass Alloy 360 Part #
3/8"	1/4"	31/32"-20	31/32"	68RB-0604B
	3/8"	31/32"-20	31/32"	68RB-0606B
	1/2"	31/32"-20	31/32"	68RB-0608B
1/2"	3/8"	1-3/32"-20	1-1/8"	68RB-0806B
	1/2"	1-3/32"-20	1-1/8"	68RB-0808B



E

### Male Connectors with Spring Guards

Hose Size	Pipe Thread	Hex	Brass Alloy 360 Part #
3/8"	1/4"	1-1/16"	68RBSG-0604
	3/8"	1-1/16"	68RBSG-0606
	1/2"	1-1/16"	68RBSG-0608
1/2"	3/8"	1-1/4"	68RBSG-0806
	1/2"	1-1/4"	68RBSG-0808



### Sleeves

Hose Size	Length	Brass Alloy 360 Part #
3/8"	.64"	60RB-06
1/2"	.64"	60RB-08



### Nuts

Hose Size	Thread	Hex	Brass Alloy 360 Part #
3/8"	31/32"-20	1-1/32"	61RB-06
1/2"	1-3/32"-20	1-1/4"	61RB-08



## Brass Push-In Fittings

### Features

- Saves up to 75% of assembly time compared to the standard compression fittings
- Quick connect: simply push tubing in, no tools required
- Quick disconnect: hold two fingers on insert and pull tubing out, no tools required
- Reusable: connect and disconnect numerous times
- Full-flow design provides up to 60% more flow than conventional fittings with internal tube supports
- Positive seal: no leaks; after tubing is inserted, seal is made
- Secure tube retention: pulling on tubing only serves to tighten the connection
- Pre-applied PTFE based pipe sealant on all male pipe threads saves customer additional labor
- Working pressure: fittings are suitable for use up to the maximum working pressure of the plastic tubing used; also suitable for vacuum service

### Specification

- Temperature range: -10°F to 200°F (-23°C to 93°C)

#### Male Connectors

Tube O.D.	Male NPTF	Forged Brass Part #	Optional Qty
1/8"	10-32 <sup>1</sup>	684X10	20
	1/8"	684X4	20
5/32"	10-32 <sup>1</sup>	685X10	20
	1/8"	685X4	20
	1/4"	685X8	10
3/16"	10-32 <sup>1</sup>	686X10	20
	1/8"	686X4	20
1/4"	10-32 <sup>1</sup>	688X10	20
	1/8"	688X4	20
	1/4"	688X8	10
	3/8"	688X12	10
3/8"	1/8"	6812X4	10
	1/4"	6812X8	10
	3/8"	6812X12	10
	1/2"	6812X16	5
1/2"	1/4"	6816X8	5
	3/8"	6816X12	5
	1/2"	6816X16	5

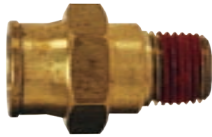

<sup>1</sup> UNF - Straight thread, supplied with gasket

#### Female Connectors

Tube O.D.	Female NPTF	Forged Brass Part #	Optional Qty
1/8"	1/8"	664X4	10
5/32"	1/8"	665X4	10
1/4"	1/8"	668X4	10
1/4"	1/4"	668X8	10
3/8"	1/4"	6612X8	10
3/8"	3/8"	6612X12	5



## Brass Push-In Fittings

### Unions

Tube O.D.	Forged Brass Part #	Optional Qty
1/8"	624	20
5/32"	625	10
1/4"	628	10
3/8"	6212	10
1/2"	6216	5



E

### Bulkhead Unions

Tube O.D.	Male NPT	Forged Brass Part #	Optional Qty
1/8"	7/16"-20	824	10
5/32"	7/16"-20	825	10
1/4"	1/2"-20	828	10
3/8"	3/4"-16	8212	5
1/2"	15/16"-16	8216	5

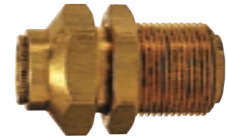

### Male Elbows

Tube O.D.	Male NPTF	Forged Brass Part #	Optional Qty
1/8"	1/8"	694X4	10
5/32"	1/8"	695X4	10
3/16"	1/8"	696X4	10
1/4"	1/8"	698X4	10
	1/4"	698X8	10
	3/8"	698X12	10
3/8"	1/8"	6912X4	10
	1/4"	6912X8	10
	3/8"	6912X12	10
1/2"	1/4"	6916X8	5
	3/8"	6916X12	5



### Female Elbows

Tube O.D.	Female NPTF	Forged Brass Part #	Optional Qty
5/32"	1/8"	705X4	10
1/4"	1/8"	708X4	10
1/4"	1/4"	708X8	5
3/8"	1/4"	7012X8	5



**Brass Push-In Fittings**

**Union Elbows**



Tube O.D.	Forged Brass Part #	Optional Qty
1/8"	654	10
5/32"	655	10
1/4"	658	10
3/8"	6512	10
1/2"	6516	5

**Male Swivel Elbows**



Tube O.D.	Male NPTF	Forged Brass Part #	Optional Qty
1/8"	1/8"	69S4X4	10
5/32"	10-32 <sup>1</sup>	69S5X10	10
	1/8"	69S5X4	10
	1/4"	69S5X8	10
	10-32 <sup>1</sup>	69S8X10	10
1/4"	1/8"	69S8X4	10
	1/4"	69S8X8	10
	3/8"	69S8X12	10
	1/8"	69S12X4	10
3/8"	1/4"	69S12X8	10
	3/8"	69S12X12	5
	1/2"	69S12X16	5
1/2"	3/8"	69S16X12	5
	1/2"	69S16X16	5

<sup>1</sup> UNF - Straight thread, supplied with gasket

**Male Branch Tees**



Tube O.D.	Male NPTF	Forged Brass Part #	Optional Qty
1/8"	1/8"	724X4	10
5/32"	1/8"	725X4	10
1/4"	1/8"	728X4	10
	1/4"	728X8	5
3/8"	1/8"	7212X4	5
	1/4"	7212X8	5
	3/8"	7212X12	5
1/2"	3/8"	7216X12	5

**Union Tees**



Tube O.D.	Forged Brass Part #	Optional Qty
1/8"	644	10
5/32"	645	10
3/16"	646	10
1/4"	648	10
3/8"	6412	5
1/2"	6416	5

## Brass Push-In Fittings

### Male Swivel Branch Tees

Tube O.D.	Male NPTF	Forged Brass Part #	Optional Qty
1/8"	1/8"	72S4X4	10
5/32"	1/8"	72S5X4	10
1/4"	1/8"	72S8X4	10
	1/4"	72S8X8	5
3/8"	1/4"	72S12X8	5
	3/8"	72S12X12	5
1/2"	3/8"	72S16X12	5
	1/2"	72S16X16	5



E

### Male Run Tees

Tube O.D.	Male NPTF	Forged Brass Part #	Optional Qty
1/8"	1/8"	714X4	10
5/32"	1/8"	715X4	10
1/4"	1/8"	718X4	10
	1/4"	718X8	5
3/8"	1/8"	7112X4	5
	1/4"	7112X8	5
	3/8"	7112X12	5
1/2"	3/8"	7116X12	5



### Male Swivel Run Tees

Tube O.D.	Male NPTF	Forged Brass Part #	Optional Qty
1/8"	1/8"	71S4X4	10
5/32"	10-32 <sup>1</sup>	71S5X10	10
	1/8"	71S5X4	5
1/4"	1/8"	71S8X4	5
	1/4"	71S8X8	5
3/8"	1/4"	71S12X8	5
	3/8"	71S12X12	5
1/2"	3/8"	71S16X12	5
	1/2"	71S16X16	5



<sup>1</sup> UNF - Straight thread, supplied with gasket.

## Stainless Steel Legris Push-In Fittings

### Applications

- Suitable for many industries such as: chemical, food, packaging, and medical

### Features

- Maximum circuit pressure depends equally on the type and diameter of the tube used.
- Materials conforming to FDA and 1934/2004 CE standards



### Materials

- Body - AISI 316 stainless steel
- Backup washer - 316L stainless steel
- Collet - 303L stainless steel
- Seal - FKM O-ring
- Thread sealant does not come pre-applied on male threads, allowing the appropriate sealant for the application to be applied by the user
- Silicone-free

### Specifications

- Temperature range: -13°F to 302°F (-25°C to 150°C)
- Maximum operating pressure: 435 PSI (30 bar)
- Vacuum capability: 28" HG

### Compatible with a range of tubes

- Semi-rigid nylon tube
- Flexible polyurethane tube
- Low density polyethylene
- PTFE tube FEP 140
- Stainless steel and copper tube (when grooved)

### Straight Male Connectors

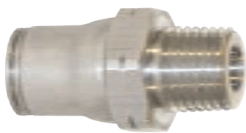

Tube O.D.	Male NPT	Stainless Steel Part #	Optional Qty
1/4"	1/8"	38055611	10
	1/4"	38055614	10
3/8"	1/4"	38056014	10
	3/8"	38056018	10
1/2"	3/8"	38056218	10
	1/2"	38056222	10

NOTE: Internal hex allows ease of assembly in tight places

### Unions



Tube O.D.	Stainless Steel Part #	Optional Qty
1/4"	38065600	10
3/8"	38066000	10
1/2"	38066200	10

### Bulkhead Connector Unions



Tube O.D.	Stainless Steel Part #	Optional Qty
1/4"	38165600	10
3/8"	38166000	10
1/2"	38166200	10

E

## Stainless Steel Legris Push-In Fittings

### Male Elbows

Tube O.D.	Male NPT	Stainless Steel Part #	Optional Qty
1/4"	1/8"	38895611	10
	1/4"	38895614	10
3/8"	1/4"	38896014	10
	3/8"	38896018	10
1/2"	3/8"	38896218	10
	1/2"	38896222	10



**E**

NOTE: Body is orientable for positioning purposes

### Equal Elbow Unions

Tube O.D.	Stainless Steel Part #	Optional Qty
1/4"	38025600	10



### Union Tees

Tube O.D.	Stainless Steel Part #	Optional Qty
1/4"	38045600	10
3/8"	38046000	10
1/2"	38046200	10



E

## Nickel-Plated Brass Legris Push-In Fittings

### Applications

- Push-to-connect forged fittings are nickel plated and have an FKM seal making them suitable to use with liquids and gaseous fluids
- Fittings are plated with a high phosphorous FDA nickel plate allowing them to be used in applications where exposure to harsh environments is present
- Applications include: food industry, packaging, robotics, pulp and paper, and wash down

### Features

- FDA compliant
- Vacuum capability: 28" HG maximum circuit pressure (depends on media, temperature and diameter of tube used)
- Full flow
- Excellent resistance to abrasion and corrosion
- Silicone free
- Available in fractional and metric sizes



### Specifications

- Temperature range: -4°F to 302°F (-20°C to 150°C)
- Pressure range: up to 435 PSI

### Construction

- Body: high phosphorous FDA nickel plated brass
- Back-up washer: high phosphorous FDA nickel plated brass
- Collet: high phosphorous FDA nickel plated brass
- O-ring: FKM fluoroelastomer conforming to FDA standards
- Base: high phosphorous FDA nickel plated brass
- Thread sealant is intentionally left off product so the appropriate sealant for the application can be applied

### Male Connectors



Tube O.D.	Male NPT	Nickel-plated Brass Part #	Optional Qty
5/32"	10-32 <sup>1</sup>	36010420	10
	1/8"	36750411	10
	1/4"	36750414	10
1/4"	10-32 <sup>1</sup>	36015620	10
	1/8"	36755611	10
	1/4"	36755614	10
	3/8"	36755618	10
3/8"	1/8"	36756011	10
	1/4"	36756014	10
	3/8"	36756018	10
	1/2"	36756022	10
1/2"	3/8"	36756218	10
	1/2"	36756222	10

<sup>1</sup> UNF - Straight thread, supplied with gasket and plastic button

### Female Connectors



Tube O.D.	Female NPT	Nickel-plated Brass Part #	Optional Qty
5/32"	1/4"	36150414	10
1/4"	1/8"	36155611	10
	1/4"	36155614	10
3/8"	1/4"	36156014	10
	3/8"	36156018	10
1/2"	3/8"	36156218	10
	1/2"	36156222	10

### Equal Unions



Tube O.D.	Nickel-plated Brass Part #	Optional Qty
5/32"	36060400	10
1/4"	36065600	10
3/8"	36066000	10
1/2"	36066200	10



## Nickel-Plated Brass Legris Push-In Fittings

### Union Elbows

Tube O.D.	Nickel-plated Brass Part #	Optional Qty
5/32"	36020400	10
1/4"	36025600	10
3/8"	36026000	10
1/2"	36026200	10



**E**

### Male Elbows

Tube O.D.	Male NPT	Nickel-plated Brass Part #	Optional Qty
5/32"	10-32 <sup>1</sup>	36990420	10
	1/8"	36090411	10
	1/4"	36090414	10
1/4"	1/8"	36095611	10
	1/4"	36095614	10
	3/8"	36095618	10
3/8"	1/4"	36096014	10
	3/8"	36096018	10
	1/2"	36096022	10
1/2"	1/2"	36096222	10



<sup>1</sup> UNF - Straight thread, supplied with gasket and plastic button  
 NOTE: Body is orientable for positioning purposes

### Union Tees

Tube O.D.	Nickel-plated Brass Part #	Optional Qty
5/32"	36040400	10
1/4"	36045600	10
3/8"	36046000	10
1/2"	36046200	10



### Male Run Tees

Tube O.D.	Male NPT	Nickel-plated Brass Part #	Optional Qty
5/32"	10-32 <sup>1</sup>	36930420	10
	1/8"	36030411	10
	1/4"	36030414	10
1/4"	1/8"	36035611	10
	1/4"	36035614	10
	3/8"	36035618	10
3/8"	1/4"	36036014	10
	3/8"	36036018	10



<sup>1</sup> UNF - Straight thread, supplied with gasket and plastic button  
 NOTE: Body is orientable for positioning purposes

## Nylon/Nickel-Plated Brass Legris Push-In Fittings

### Features

- Positive seal: sealing and holding is accomplished instantaneously
- Reusable: connect and disconnect numerous times
- Full flow: fitting seals on outside diameter of tubing
- Pre-applied thread sealant on all tapered male pipe threads
- Compatible tubing: semi-rigid nylon, polyurethane, and polyethylene tube
- Maximum circuit pressure depends equally on the type and diameter of the tube used 

### Materials

- Nickel-plated brass threads; black body is glass-filled nylon; nitrile rubber D-seal; polypropylene release button; silicone-free

### Specifications

- Working pressure: **290 PSI** at ambient temperature
- Temperature range: **-4°F to 175°F (-20°C to 79°C)**
- Vacuum capability: vacuum of 28" Hg (99% vacuum)

### Quick Connect and Disconnect

- To connect, simply push tubing in
- To disconnect, press the release ring towards the fitting and pull tubing out
- No tools required

### Gripping Ring Technology



### Male Connectors



Tube O.D.	Male NPT	Nylon / Nickel-plated Brass Part #	Optional Qty
1/8"	1/16"	31755308	10
	1/8"	31755311	10
	1/4"	31755314	10
5/32"	1/8"	31750411	10
	1/4"	31750414	10
1/4"	1/8"	31755611	10
	1/4"	31755614	10
	3/8"	31755618	10
5/16"	1/8"	31750811	10
	1/4"	31750814	10
	3/8"	31750818	10
3/8"	1/8"	31756011	10
	1/4"	31756014	10
	3/8"	31756018	10
	1/2"	31756022	10
1/2"	1/4"	31756214	10
	3/8"	31756218	10
	1/2"	31756222	10

### Female Connectors



Tube O.D.	Female NPT	Nylon / Nickel-plated Brass Part #	Optional Qty
1/8"	1/8"	30145311	10
	1/4"	30145314	10
5/32"	1/8"	30140411	10
	1/4"	30140414	10
1/4"	1/8"	30145611	10
	1/4"	30145614	10
5/16"	1/8"	30140811	10
	1/4"	30140814	10
3/8"	1/8"	30146011	10
	1/4"	30146014	10
	3/8"	30146018	10

### Hybrid Male Connectors



Tube O.D.	Male BSPT	Nylon / Nickel-plated Brass Part #	Optional Qty
1/4"	1/8"	31755610	10
	1/4"	31755613	10
3/8"	1/4"	31756013	10

## Nylon/Nickel-Plated Brass Legris Push-In Fittings

### Female Elbows

Tube O.D.	Female NPT	Nylon / Nickel-Plated Brass Part #	Optional Qty
1/8"	1/8"	30095311	10
5/32"	1/4"	30090414	10
1/4"	1/8"	30095611	10
	1/4"	30095614	10
5/16"	1/8"	30090811	10
	1/4"	30090814	10
3/8"	1/4"	30096014	10
1/2"	3/8"	30096218	10



E

### Male Elbows

Tube O.D.	Male NPT	Nylon / Nickel Plated Brass Part #	Optional Qty
1/8"	10-32 <sup>1</sup>	31095320	10
	1/16"	31095308	10
	1/8"	31095311	10
	1/4"	31095314	10
5/32"	10-32 <sup>1</sup>	31090420	10
	1/8"	31090411	10
	1/4"	31090414	10
1/4"	10-32 <sup>1</sup>	31095620	10
	1/8"	31095611	10
	1/4"	31095614	10
	3/8"	31095618	10
5/16"	1/8"	31090811	10
	1/4"	31090814	10
	3/8"	31090818	10
3/8"	1/8"	31096011	10
	1/4"	31096014	10
	3/8"	31096018	10
	1/2"	31096022	10
	1/4"	31096214	10
1/2"	3/8"	31096218	10
	1/2"	31096222	10



<sup>1</sup> UNF - Straight thread, supplied with gasket  
 NOTE: Body is orientable for positioning purposes

### 45° Male Elbows

Tube O.D.	Male NPT	Nylon / Nickel Plated Brass Part #	Optional Qty
1/4"	1/8"	31135611	10
	1/4"	31135614	10
3/8"	1/4"	31136014	10
	3/8"	31136018	10



NOTE: Body is orientable for positioning purposes

### Extended Male Elbows

Tube O.D.	Male NPT	Nylon / Nickel Plated Brass Part #	Optional Qty
1/4"	1/8"	31295611	10
	1/4"	31295614	10
3/8"	1/4"	31296014	10
	3/8"	31296018	10



NOTE: Body is orientable for positioning purposes

**Nylon/Nickel-Plated Brass Legris Push-In Fittings**

**Male Branch Tees**

Tube O.D.	Male NPT	Nylon / Nickel-Plated Brass Part #	Optional Qty
1/8"	10-32 <sup>1</sup>	31085320	10
	1/8"	31085311	10
5/32"	10-32 <sup>1</sup>	31080420	10
	1/8"	31080411	10
	1/4"	31080414	10
1/4"	1/8"	31085611	10
	1/4"	31085614	10
	3/8"	31085618	10
5/16"	1/8"	31080811	10
	1/4"	31080814	10
	3/8"	31080818	10
3/8"	1/8"	31086011	10
	1/4"	31086014	10
	3/8"	31086018	10
	1/2"	31086022	10
1/2"	1/4"	31086214	10
	3/8"	31086218	10
	1/2"	31086222	10



E

<sup>1</sup> UNF - Straight thread, supplied with gasket  
 NOTE: Body is orientable for positioning purposes

**Male Run Tees**

Tube O.D.	Male NPT	Nylon / Nickel-Plated Brass Part #	Optional Qty
1/8"	10-32 <sup>1</sup>	31035320	10
	1/16"	31035308	10
	1/8"	31035311	10
5/32"	10-32 <sup>1</sup>	31030420	10
	1/8"	31030411	10
	1/4"	31030414	10
1/4"	1/8"	31035611	10
	1/4"	31035614	10
	3/8"	31035618	10
5/16"	1/8"	31030811	10
	1/4"	31030814	10
3/8"	1/8"	31036011	10
	1/4"	31036014	10
	3/8"	31036018	10
1/2"	1/4"	31036214	10
	3/8"	31036218	10
	1/2"	31036222	10



<sup>1</sup> UNF - Straight thread, supplied with gasket  
 NOTE: Body is orientable for positioning purposes

**Push-In Male Wyes**

Tube O.D.	Male NPT	Nylon / Nickel Plated Brass Part #	Optional Qty
5/32"	1/8"	31480411	10
	1/4"	31480414	10
1/4"	1/8"	31485611	10
	1/4"	31485614	10



NOTE: Body is orientable for positioning purposes

## Nylon Legris Push-In Fittings

### Unions

Tube O.D.	Nylon Part #	Optional Qty
1/8"	31065300	10
5/32"	31060400	10
1/4"	31065600	10
5/16"	31060800	10
3/8"	31066000	10
1/2"	31066200	10



### Bulkhead Unions

Tube O.D.	Nylon Part #	Optional Qty
1/8"	31165300	10
5/32"	31160400	10
1/4"	31165600	10
5/16"	31160800	10
3/8"	31166000	10
1/2"	31166200	10



### Union Elbows

Tube O.D.	Nylon Part #	Optional Qty
1/8"	31025300	10
5/32"	31020400	10
1/4"	31025600	10
5/16"	31020800	10
3/8"	31026000	10
1/2"	31026200	10



### Plugs

Tube O.D.	Plastic Part #	Optional Qty
1/8"	31265300	10
5/32"	31260400	10
1/4"	31265600	10
5/16"	31260800	10
3/8"	31266000	10
1/2"	31266200	10



### Union Tees

Tube O.D.	Nylon Part #	Optional Qty
1/8"	31045300	10
5/32"	31040400	10
1/4"	31045600	10
5/16"	31040800	10
3/8"	31046000	10
1/2"	31046200	10



### Tube Wyes

Tube O.D.	Nylon Part #	Optional Qty
1/8"	31405300	10
5/32"	31400400	10
1/4"	31405600	10
5/16"	31400800	10
3/8"	31406000	10



E

## Nylon / Nickel-Plated Brass Legris Push-In Fitting Kit

**Features**

- Kit includes plastic case with threaded connectors, threaded elbows and several tube-to-tube connector configurations found on pages 249 - 251
- A tubing cutter is also included

E



**Part #**

TFK

**Kit contains the following parts:**

Part #	Qty	Description
31755311	10	tube to male NPT connector
31750411	10	tube to male NPT connector
31755611	10	tube to male NPT connector
31755614	10	tube to male NPT connector
31756014	5	tube to male NPT connector
31756018	5	tube to male NPT connector
31090411	10	tube to male NPT elbow
31095611	10	tube to male NPT elbow
31095614	10	tube to male NPT elbow
31096011	5	tube to male NPT elbow
31096014	5	tube to male NPT elbow
31096018	5	tube to male NPT elbow
31060400	10	tube to tube union
31065600	10	tube to tube union
31066000	5	tube to tube union
31400400	10	Y connector
31405600	10	Y connector
31406000	5	Y connector
31040400	10	tube to tube union tee
31045600	5	tube to tube union tee
31046000	5	tube to tube union tee
30007100	1	tubing cutter



### Legris Modular Manifold

**Feature**

- Manifold with push-to-connect ports

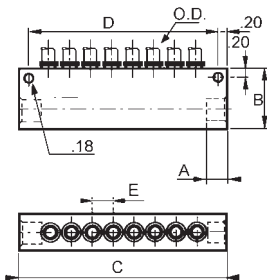

O.D.	NPT Size	Number of Outlets	Dimensions					Part #
			A	B	C	D	E	
1/4"	1/4"	8	.55	1.30	4.92	4.53	.50	33155614

### Legris Composite Mini Ball Valves

**Application**

- Valves enable in-line opening and closing of a pneumatic circuit

**Features**

- 2-way, non-venting valve
- Compact and lightweight, suited to all types of installation
- Suitable fluid: compressed air
- A screwdriver slot allows opening and closing even when access is difficult
- Handle is differentiated by a blue color and marked with the corresponding pneumatic symbol enabling immediate identification by the user

**Material**

- Nylon body with nickel-plated brass ball

**Specifications**

- Maximum operating pressure: **145 PSI**
- Vacuum rating: vacuum of 28" Hg (99% of vacuum)
- Temperature range: **-4°F to 175°F (-20°C to 79°C)**



E

Size	Part #
5/32"	79100400
1/4"	79105600
5/16"	79100800
3/8"	79106000

### Legris Quick Exhaust Valves

**Application**

- Can be used with all pneumatic equipment

**Features**

- Increases system efficiency and the speed of a cylinder by purging cylinder air at the cylinder port rather than the control valve

**Materials**

- Body: nickel-plated brass
- Piston: polyurethane
- Seals: nylon

**Specifications**

- Pressure range: **10 PSI to 150 PSI**
- Temperature range: **0°F to 160°F (-17°C to 71°C)**

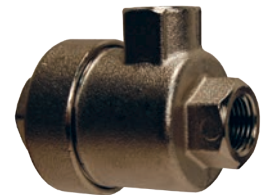

NPT Thread	Part #
1/8"	79821111
1/4"	79821414
3/8"	79821818
1/2"	79822222

### Legris Compact Flow Control Valves

**Features**

- Valves control the speed of a cylinder by regulating air exhaust. Intake air flows freely through the flow control and exhaust air is metered out through a specially designed fine adjustment screw
- Push-to-connect, meter out flow control, one-piece design

**Material**

- Body: nylon

**Specifications**

- Control pressure range: **15 PSI to 145 PSI**
- Temperature range: **32°F to 158°F (0°C to 70°C)**



Tube O.D.	NPT Size	Part #	Optional Qty
5/32"	1/8"	70650411	10
1/4"	1/8"	70655611	10
	1/4"	70655614	10
3/8"	1/4"	70656014	10
	3/8"	70656018	10

## Legris Flow Control Valves

### Miniature Exhaust

**Features**

- Control the speed of a cylinder by regulating air exhaust
- Exhaust air is metered out through a specially designed fine adjustment screw
- Push-to connect, meter out flow control, one-piece design

**Materials**

- Body: nylon

**Specifications**

- Control pressure range: **15 PSI to 145 PSI**
- Temperature range: **30°F to 158°F (-1°C to 70°C)**



E

Tube O.D.	NPT Size	Part #	Optional Qty
5/32"	10-32 <sup>1</sup>	76600420	10
	1/8"	76650411	10
1/4"	10-32 <sup>1</sup>	76605620	10
	1/8"	76655611	10
	1/4"	76655614	10

<sup>1</sup> UNF - Straight thread, supplied with gasket

### In-Line

**Application**

- Used where cylinder access is difficult or another fitting is attached to the cylinder port

**Features**

- Working fluid: compressed air
- Stackable using the two joining clips supplied or panel mountable using existing holes

**Materials**

- Body: nylon
- Gripping ring: stainless steel
- Adjustment screw: nickel plated brass
- Locking nut: nickel plated brass

**Specifications**

- Pressure range: **15 PSI to 145 PSI**
- Temperature range: **32°F to 158°F (0°C to 70°C)**



Tube O.D.	Part #	Optional Qty
5/32"	77700400	10
1/4"	77705600	10
3/8"	77706000	10
1/4"	77706200	10

### Threaded In-Line

**Features**

- Intake air flows freely through the flow control; exhaust air is metered out through an adjustment screw
- Arrow on the body of the valve indicates the direction of controlled flow
- May be installed as meter in or meter out devices
- Unidirectional flow control valves
- Working fluid: compressed air

**Materials**

- Body: nylon with nickel plated brass thread
- Adjustment screw: nickel-plated brass
- Locking nut: nickel-plated brass
- Threads: nickel-plated brass

**Specifications**

- Pressure range: **15 PSI to 145 PSI**
- Temperature range: **32°F to 158°F (0°C to 70°C)**



Female NPT	Part #
1/8"	77751111
1/4"	77751414
3/8"	77751818
1/2"	77752222



## Legris Check Valves

### Non-Return In-Line

#### Features

- Allows air to pass in one direction while blocking flow in the other direction, a pressure of more than **7 PSI** will overcome the spring pressure and allow flow
- Arrow indicates free flow direction

#### Material

- Body: nylon/nickel plated brass

#### Specifications

- Maximum operating pressure: **145 PSI** at ambient temperature **70°F (21°C)**

Tube O.D.	Part #	Optional Qty
5/32"	79960400	10
6mm	79960600	10
1/4"	79965600	10
5/16"	79960800	10



E

### In-Line

#### Application

- Suitable as a safety item in compressed air circuits

#### Features

- Compact, lightweight design meter out check valves
- Allows air to pass in one direction while blocking flow in the other direction
- Arrow on body of the fitting indicates direction of flow, a pressure of more than **7 PSI** will overcome spring pressure keeping the valve closed, thus allowing the passage of air
- Pre-applied thread sealant on tapered threads

#### Material

- Body: nylon with nickel plated brass base

#### Specification

- Pressure range: **15 PSI** to **145 PSI** at ambient temperature **70°F (21°C)**

Tube O.D.	NPT Size	Part #
5/32"	10-32 <sup>1</sup>	79940420
	1/8"	79950411
1/4"	1/8"	79955611
	1/4"	79955614
3/8"	1/4"	79956014
	3/8"	79956018



<sup>1</sup> UNF - Straight thread, supplied with gasket

### Uni-Directional

#### Features

- Blocks the fluid passage when the pressure differential is lower than **3.6 PSI**

#### Materials

- Body: 316L stainless steel
- Shut-off valve: 316L stainless steel
- Return spring: 302 stainless steel
- Seals: FKM

#### Specifications

- Pressure range: **7 PSI** to **580 PSI**
- Temperature range: **-4°F** to **356°F (-20° to 180°C)**

NPT Thread	Part #
1/8"	48951111
1/4"	48951414
3/8"	48951818
1/2"	48952222



### Legris Metric Push-In Fittings

**Features**

- Positive seal: sealing and holding is accomplished instantaneously
- Reusable: connect and disconnect numerous times
- Full flow: fitting seals on outside diameter of tubing
- Pre-applied thread sealant on all tapered male pipe threads
- Compatible tubing: semi-rigid nylon, polyurethane, and polyethylene tube

**Gripping Ring Technology**



**Materials**

- Nickel-plated brass, black glass-filled nylon body, nitrile rubber D-seal, polypropylene release button, silicone-free and nylon nickel plated brass, or nylon

**E**

**Specifications**

- Pressure rating: **290 PSI** at ambient temperature
- Temperature range: **-4°F to 175°F (-20°C to 79°C)**
- Vacuum rating: vacuum of 28" Hg (99% vacuum)

**Quick Connect and Disconnect**

- To connect: simply push tubing in
- To disconnect: press the release ring towards the fitting and pull tubing out
- No tools required

**Male BSPT Connectors**



Tube O.D.	Male BSPT	Nickel Plated Brass Part #	Optional Qty
4 mm	1/8"	31750410	10
	1/4"	31750413	10
6 mm	1/8"	31750610	10
	1/4"	31750613	10
8 mm	1/8"	31750810	10
	1/4"	31750813	10
	3/8"	31750817	10
10 mm	1/4"	31751013	10
	3/8"	31751017	10

NOTE: Internal hex allows ease of assembly in tight places

**Female BSPP Connectors**

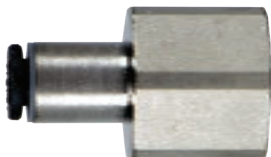

Tube O.D.	Female BSPP	Nickel Plated Brass Part #	Optional Qty
4 mm	1/8"	31140410	10
	1/4"	31140413	10
6 mm	1/8"	31140610	10
	1/4"	31140613	10
8 mm	1/8"	31140810	10
	1/4"	31140813	10

**Male BSPT Elbows**



Tube O.D.	Male BSPT	Nylon / Nickel Plated Brass Part #	Optional Qty
4 mm	1/8"	31090410	10
	1/4"	31090413	10
6 mm	1/8"	31090610	10
	1/4"	31090613	10
8 mm	1/8"	31090810	10
	1/4"	31090813	10
	3/8"	31090817	10
10 mm	1/4"	31091013	10
	3/8"	31091017	10

NOTE: Body is orientable for positioning purposes

### Legris Metric Push-In Fittings Male Branch Tees

Tube O.D.	Male BSPT	Nylon / Nickel Plated Brass Part #	Optional Qty
4 mm	1/8"	31080410	10
	1/4"	31080413	10
6 mm	1/8"	31080610	10
	1/4"	31080613	10
8 mm	1/8"	31080810	10
	1/4"	31080813	10



NOTE: Body is orientable for positioning purposes

### Nylon Tubing

#### Features

- Translucent color
- Resistant to fungus, abrasion, moisture, and UV

#### Specification

- Temperature range: -60°F to 200°F (-51°C to 93°C)

Size		Wall Thickness	Working Pressure @ 75°F (24°C)	Length	Part #
O.D.	I.D.				
4 mm	2.7 mm	.65 mm	350	25 m	1025P0400
6 mm	4 mm	1 mm	340	25 m	1025P0600
8 mm	6 mm	1 mm	250	25 m	1025P0800



NOTE: Tubing cutters sold on page 1003

### Male Threaded Connectors

#### Feature

- Internal hex allows ease of assembly in tight places

Tube O.D.	Male Thread	Nickel Plated Brass Part #	Optional Qty
4 mm	M5	31010419	10
	1/8 BSPP	31010410	10
6 mm	M5	31010619	10
	1/8 BSPP	31010610	10
	1/4 BSPP	31010613	10
8 mm	1/8 BSPP	31010810	10
	1/4 BSPP	31010813	10
10 mm	1/4 BSPP	31011013	10



### Bulkhead Union

Tube O.D.	Tube O.D.	Nylon Part #	Optional Qty
6 mm	6 mm	31160600	10



### Unions

Tube O.D.	Tube O.D.	Nylon Part #	Optional Qty
4 mm	6 mm	31060406	10
6 mm	6 mm	31060600	10
10 mm	10 mm	31061000	10



**Legris Metric Push-In Fittings**

**Male Elbows**



E

Tube O.D.	Male Thread	Nylon / Nickel Plated Brass Part #	Optional Qty
4 mm	M5	31990419	10
	1/8 BSPP	31990410	10
6 mm	M5	31990619	10
	1/8 BSPP	31990610	10
	1/4 BSPP	31990613	10
8 mm	1/8 BSPP	31990810	10
	1/4 BSPP	31990813	10
10 mm	1/4 BSPP	31991013	10

NOTE: Body is orientable for positioning purposes

**Union Elbows**



Tube O.D.	Tube O.D.	Nylon Part #	Optional Qty
6 mm	6 mm	31020600	10
10 mm	10 mm	31021000	10

**Union Tees**



Tube O.D.	Nylon Part #	Optional Qty
6 mm	31040600	10
10 mm	31041000	10

**Y Connector**



Tube O.D.	Tube O.D.	Nylon Part #	Optional Qty
6 mm	6 mm	31400600	10

**Plugs**



Tube O.D.	Tube O.D.	Plastic Part #	Optional Qty
6 mm	6 mm	31260600	10
10 mm	10 mm	31261000	10

**Safety Cables .....261 - 263**

King Cable® .....261  
 Nylon safety restraints .....262  
 King safety whipsocks .....263  
 King safety shackles .....263  
 ASME air receiver manifold with King safety whipsock .....263

**Air Tanks and Manifolds ..... 264 - 267**

ASME air receiver manifolds ..... 264 - 265  
 Whip hose assemblies .....265  
 Manifolds ..... 266 - 267  
 Compressor Y .....267  
 Lubricants .....267

**In-Line Lubricators and Filters .....268 - 269**

Lubricators .....268  
 Air filter .....268  
 Nipple filters .....269  
 Lubricator with filter .....269  
 Mini lubricators .....269

**Valves, Mufflers, and Vents.....270 - 276**

Safety check valves .....270  
 Conical mufflers .....271  
 Speed control mufflers .....271  
 Breather vents .....271  
 Quiet flow economy pneumatic silencers/mufflers.....272  
 Keychain .....272  
 Mini in-line filter .....272  
 General purpose regulators .....272  
 Needle valves .....273  
 Desiccant dryer .....273  
 Button and tank filler valves .....274  
 Brass lever external drains .....274  
 Brass external drain cocks .....274  
 Safety pop-off valves .....275  
 Flow control valves .....276  
 Series C check valves .....276

**Blow guns .....277 - 281**

Safety ..... 277 - 278  
 Pistol Grip .....278  
 Non-Safety ..... 278 - 279  
 Heavy duty .....280  
 High volume ..... 280 - 281

**Air Hose.....282 - 283**

Coil-Chief self-storing .....282  
 Polyurethane ..... 282 - 283  
 Industrial coupler blow gun .....283

**Tire pressure gauges..... 284**

**Swivels ..... 285**

Ball .....285  
 In-line .....285  
 Air tool .....285

**Hose Reels.....286 - 287**

Reelcraft® ..... 286 - 287  
 5000-Series .....286  
 7000-Series .....286  
 80000 Series .....287  
 30000 manual driven.....287

**FRLs .....288 - 338**

Wilkerson ..... 288 - 316  
 Miniatures ..... 288 - 291  
 Filters ..... 292 - 296  
 Manual in-line desiccant dryer .....297  
 Regulators ..... 297 - 301  
 Filter / regulator..... 302 - 303  
 Lubricators..... 303 - 306  
 Combination units ..... 306 - 310  
 Exhaust mufflers .....310  
 Automatic drains .....311  
 Lockout valves.....311  
 Accessories and repair kits ..... 312 - 316  
 Series 1 ..... 317 - 337  
 Miniatures ..... 317 - 319  
 Filters ..... 319 - 322  
 Regulators ..... 323 - 326  
 Filter / regulators ..... 326 - 328  
 Lubricators..... 328 - 331  
 Combination units .....332  
 Automatic drains .....333  
 Accessories and repair kits ..... 333 - 338

**⚠ WARNING**

The constant vibration created by air tools, like air drills and pavement breakers, is destructive to air hose couplings, especially the quick-acting type. To provide protection against coupling breakage and related hazards, Dixon® recommends the use of a whip hose. To construct a whip hose, connect one end of a short (3' to 10') air hose to the air tool using a 3500 type steel nipple. Connect the other end of the hose to the air supply using the standard quick-acting coupling. The heat-treated 3500 nipple will withstand vibration far better than the standard coupling and provide a safer connection. The whip hose should remain permanently connected to the tool.



### **FRLs (cont.) .....339 - 344**

Watts.....	339 - 344
Filters .....	339
Regulators .....	340 - 341
Lubricators.....	342
Combination units.....	343
Accessories and repair kits .....	343 - 344

### **Gauges .....345 - 354**

Dry .....	345 - 348
Process.....	347
Panel builder.....	349
Contractor pressure.....	349
Compound .....	350
Vacuum.....	350
Liquid filled .....	351 - 353
Welding.....	353
Digital.....	354
180° steam gauge siphons.....	354

### **Thermometers .....355 - 356**

Bi-metal.....	355 - 356
Magnetic surface mount .....	356
Threaded thermowell .....	356

### **⚠ WARNING**

The constant vibration created by air tools, like air drills and pavement breakers, is destructive to air hose couplings, especially the quick-acting type. To provide protection against coupling breakage and related hazards, Dixon® recommends the use of a whip hose. To construct a whip hose, connect one end of a short (3' to 10') air hose to the air tool using a 3500 type steel nipple. Connect the other end of the hose to the air supply using the standard quick-acting coupling. The heat-treated 3500 nipple will withstand vibration far better than the standard coupling and provide a safer connection. The whip hose should remain permanently connected to the tool.

### King Cable®

**Application**

- When hose, couplings, or clamps fail, or there is an accidental separation of the assembly, King safety cables minimize damage to equipment and injuries to operators.

**Features**

- Must be installed in the extended position (no slack)
- Cable reaches across hose fittings to provide standby safety for hose
- Spring-loaded loops in the cable ends open easily to pass over the couplings for a firm grip on the hose
- No tools needed - easy to install and remove
- Cables shipped with safety restraint labels attached
- Highly resistant to rust and corrosion
- Hose-to-hose or hose-to-rigid outlet

**Materials**

- For WB1, WB3, WA2, WA4, WSR1, WSR3, WSR2, WSR4, WSR1C, WB1C, WSR1E:
  - wire rope - galvanized carbon steel
  - ferrules - aluminum
  - springs - galvanized carbon steel
- For WB1SS, WB3SS, WA2SS, WA4SS, WSR1SS, WSR2SS, WSR3SS, WSR4SS:
  - wire rope - 304 stainless steel
  - ferrules - copper
  - springs - 304 stainless steel
- For WA2B:
  - wire rope - galvanized carbon steel
  - ferrules - copper
  - springs - galvanized carbon steel



**Specification**

- Maximum operating pressure: **200 PSI**

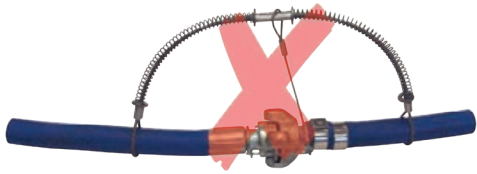

Incorrect installation

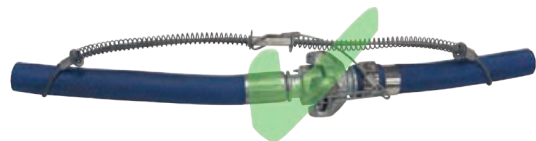

Correct installation

**Hose-to-Tool Service**



Hose end

Tool end

Hose I.D.	Cable	Length	Maximum Working Pressure (PSI)	Steel Part #	Stainless Steel Part #
1/2" - 1-1/4"	1/8"	20-1/4"	200	WSR1	WSR1SS
1/2" - 2"	3/16"	28"	200	WSR3	WSR3SS
1-1/2" - 3"	1/4"	38"	200	WSR2	WSR2SS
4"	3/8"	44"	200	WSR4	WSR4SS

**Hose-to-Hose Service**



Hose end

Hose end

Hose I.D.	Cable	Length	Maximum Working Pressure (PSI)	Steel Part #	Stainless Steel Part #
1/2" - 1-1/4"	1/8"	20-1/4"	200	WB1	WB1SS
1/2" - 2"	3/16"	28"	200	WB3	WB3SS
1-1/2" - 3"	1/4"	38"	200	WA2	WA2SS
4"	3/8"	44"	200	WA4	WA4SS

**King Cable Options**



WB1C - WB1 with safety clip and lanyard



WSR1E - WSR1E with stainless steel marine eye

Hose I.D.	Cable	Part #	Description	Maximum Working Pressure (PSI)
1/2" - 1-1/4"	1/8"	WSR1C	WSR1 with safety clip and lanyard used to lock Air King® couplings	200
1/2" - 1-1/4"	1/8"	WB1C	WB1 with safety clip and lanyard used to lock Air King couplings	200
1/2" - 1-1/4"	1/8"	WSR1E	WSR1 with stainless steel safety marine eye used to connect safety cable to a bolt on tool	200
1-1/2" - 3"	1/4"	WA2B	WA2 with bronze/copper ferrule for special environmental conditions	200



## Nylon Safety Restraints

### Applications

- Pneumatic, hydraulic, and water hoses

### Features

- Strong, flexible nylon webbing
- Superior corrosion and spark resistance over metal restraints
- Rubber grommets securely choke eyes around hose
- Must be installed in the extended position (no slack)
- Shipped with labels detailing working pressures and safety instructions
- Minimizes damage to equipment and injuries to operators in the event hose, couplings or clamps fail, or there is an accidental separation of the assembly
- Contact Dixon at 888.226.4673 for additional options

### Materials

- Strap: nylon
- Grommets: rubber

### Specification

- Maximum working temperature: 200°F (93°C)



Length	Recommended for use on the following hose inside diameters:								Nylon Part #
	1/4"	1/2"	3/4"	1"	2"	3"	4"	6"	
	Hose maximum working pressure (PSI) for above hose I.D.s								
30"	26,000	6,500	2,900	1,650	400	---	---	---	WBN130
40"	---	---	---	1,650	400	175	100	---	WBN140
30"	52,000	13,000	5,800	3,300	750	---	---	---	WBN230
44"	---	---	---	3,300	750	350	200	---	WBN244
64"	---	---	---	---	750	350	200	90	WBN264
44"	---	---	---	7,300	1,800	820	450	---	WBN344
64"	---	---	---	---	1,800	820	460	200	WBN364
64"	---	---	---	---	2,300	1,040	580	260	WBN464

F



## King Safety Whipsocks

### Application

- Ideally suited for applications where the media being transferred is under higher working pressures such as air, water, hydraulic, and slurry

### Features

- King safety whipsocks keep the hose under control in the event of a high-pressure hose assembly failure
- Dual anchor points secured beyond the fittings eliminate hose whip
- Be sure the anchoring points are rated for the application
- Galvanized steel woven stockings extend down the hose to grip securely over a larger area preventing whip, abrasion, and wear
- Securing both eye-to-rigid or eye-to-eye anchor points reduce whip in the event of a hose connection failure
- Contact Dixon® with questions regarding working pressure, available options, or custom configurations



KSW32

F

### Materials

- Wire rope: galvanized carbon steel
- Ferrules: aluminum

Size	O.D. Range	Length	Max. Working Pressure PSI	Part #
3/8"	.315" - .5512"	15.75"	5,000	KSW06
1/2"	.5512" - .7874"	21.65"	3,000	KSW08
3/4"	.7874" - 1.181"	25.20"	2,000	KSW12
1"	1.181" - 1.575"	34.25"	1,500	KSW16
1-1/4"	1.575" - 1.969"	38.19"	1,000	KSW20
1-1/2"	1.969" - 2.362"	49.21"	700	KSW24
2"	2.362" - 2.756"	51.18"	1,300	KSW32
2-1/2"	2.756" - 3.346"	53.15"	800	KSW40
3"	3.346" - 3.937"	72.44"	750	KSW48
3-1/2"	3.937" - 4.724"	72.05"	550	KSW56
4"	4.724" - 5.512"	86.61"	550	KSW64
6"	5.512" - 7.087"	93.31"	250	KSW96



KSW40

## King Safety Shackles

### Applications

- Two shackles are used to anchor the King safety whipsock
- Secure both eyes to a rigid anchor point to reduce whip in the event of a hose or connection failure

### Features

- Recommended bolt, nut, and cotter pin style shackle
- Caution: working load must be rated for the application



Size	Working Load	Fits KSW Eye	Micro Alloy Steel Part #
5/16"	3/4 ton (1,000 lbs)	KSW06-KSW12	KSS04
7/16"	1-1/2 ton (3,000 lbs)	KSW16-KSW40	KSS06
5/8"	3-1/4 ton (6,000 lbs)	KSW48-KSW96	KSS08

## ASME Air Receiver Manifold with King Safety Whipsock for Supply Hose

### Features

- 7-gallon capacity
- Painted supply orange
- All openings are female NPT thread
- Includes KSW32 2" King safety whipsock for air supply hose
- Shackles included to attach King Safety Whipsock to frame

### Specifications

- Working pressure: **200 PSI**
- Built to ASME Code, National Board registered
- Conforms to OSHA standards 1910.169 and 1926.306



Qty	Part #
1	1217AR-4AK-KSW

## ASME Air Receiver Manifolds

### Features

- 7-gallon capacity
- Painted safety orange
- All openings are female NPT thread
- Special configurations available

### Specifications

- Working pressure: **200 PSI**
- Built to ASME Code, National Board registered
- Conforms to OSHA standards 1910.169 and 1926.306



1217AR-4AK

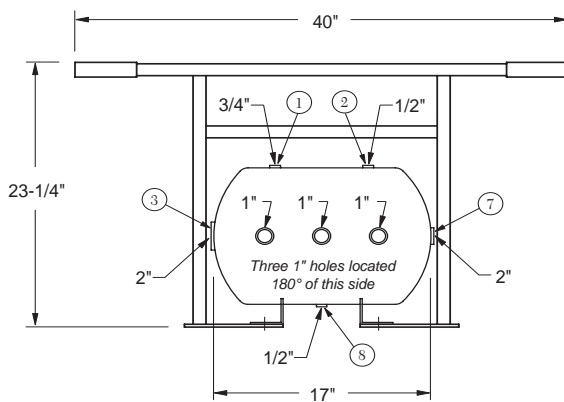

1217AR-4FR

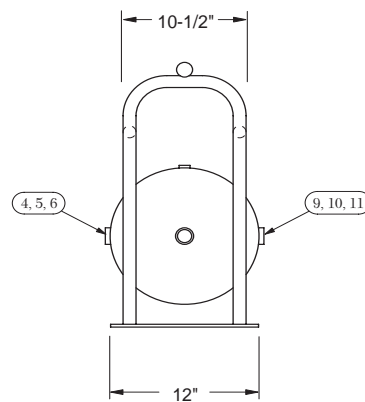

Dixon® 1217AR-4AK air receiver manifold assembly with Air King® outlet ports includes the following components:

Part # / Locations	Qty	Description
1217AR-4	1	ASME compressed air receiver
1217FRAME	1	protective frame
Location 1	1	3731204C 3/4" male x 1/4" female hex bushing
Location 2	1	GL345 <b>0-300 PSI</b> gauge
Location 3	1	3730804C 1/2" male x 1/4" female hex bushing
Locations 4, 5, 6, 9, 10, 11	1	SV200 safety pop-off valve
Location 7	1	GM28 2" male spud
Location 8	1	B27SC wing nut cap
	6	HB1075G 1" male x 3/4" female bushings
	6	3701212C 3/4" brass hex nipples
	6	BBLV75 ball valves
	6	SCVS6 safety shut-off valves
	6	AM7 Air King universal couplings
	4	SE45100 45° street elbow (1 each in locations 4, 6, 9 and 11 only)
	1	HB2075 2" male x 3/4" female bushing
	1	3701212C 3/4" brass hex nipples
	1	BBLV75 ball valve
	1	SCVS6 safety shut-off valve
	1	AM7 Air King universal coupling
	1	3730804C 1/2" male x 1/4" female hex bushing
	1	D04 1/4" drain cock
	---	---
1217AR-4AK	1	7-gallon ASME compressed air receiver manifold complete assembly with Air King
		Tank and Frame only
1217AR-4FR	1	7-gallon ASME compressed air receiver with frame only

## ASME Air Receiver Manifold Assembly with Air King® Fittings & Watts Filter

### Application

- Designed to remove compressed air contaminants such as water, compressor oil, dirt, pipe scale, and water particles from the air supply at the point of entry into the ASME air receiver manifold

### Features

- Includes basic 1217AR-4AK ASME manifold assembly
- F602-16WJR 2" auto drain filter with 26 ounce metal bowl and related plumbing installed on the inlet port of the ASME air receiver manifold
- Air supply hose connects directly to GM28 2" male spud on the filter air inlet
- Includes a B27SC wing nut cap with a chain



Hose Size	Thread	Part #
2"	3/4"	1217AR-4AKWF

## Whip Hose Assemblies

### 7/8"-24 Male Threaded Bent Stem Swivel x Global Air King Fitting

### Application

- Designed to be threaded in to a pneumatic tool to better handle the impact and vibration often associated with these applications

### Features

- The bent stem swivel is hardened and fits the following tool brands: Ingersoll-Rand, Thor, Black & Decker, Harper, Jet, Texas Pneumatic, Kent, and Sullair
- The whip hose should stay with the air tool, like a power cord stays with an appliance

### Specifications

- Working pressure: 150 PSI
- Temperature range: -4°F to 212°F (-20°C to 100°C)

Size	I.D.	Length	Rubber Hose Part #
7/8"	1/2"	6'	WH50X6AKBS87



### 1/2" Male Threaded Bent Stem Swivel x Global Air King Fitting

### Application

- Designed to be threaded in to a pneumatic tool to better handle the impact and vibration often associated with these applications

### Features

- The bent stem swivel is hardened and fits all tools with 1/2" female NPT thread
- The whip hose should stay with the air tool, like a power cord stays with an appliance

### Specifications

- Working pressure: 150 PSI
- Temperature range: -4°F to 212°F (-20°C to 100°C)

Size	I.D.	Length	Rubber Hose Part #
1/2"	1/2"	6'	WH50X6AKBS50



### 3/4" Male Threaded Bent Stem Swivel x Global Air King Fitting

### Application

- Designed to be threaded in to a pneumatic tool to better handle the impact and vibration often associated with these applications

### Features

- The bent stem swivel is hardened and fits all tools with 3/4" female NPT thread
- The whip hose should stay with the air tool, like a power cord stays with an appliance

### Specifications

- Working pressure: 150 PSI
- Temperature range: -4°F to 212°F (-20°C to 100°C)

Size	I.D.	Length	Rubber Hose Part #
3/4"	3/4"	6'	WH75X6AK35



## Bar Manifolds

### Features

- Can be mounted on a wall or work bench, safely distributing four hose lines to a work area
- Brass hex head plugs sold on page 455



### Specification

- Maximum operating pressure: **300 PSI** at ambient temperature **70°F (21°C)**

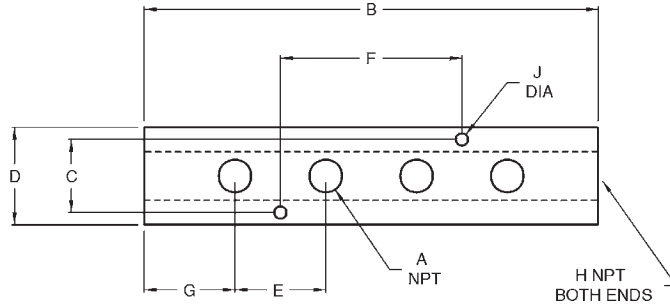

Aluminum Part #	A	B	C	D	E	F	G	H	J
AMF32	1/4"	7-5/8"	7/8"	1-1/4"	1-7/8"	3-3/4"	1"	3/8"	.20"
AMF42	1/4"	7-5/8"	1-1/8"	1-1/2"	1-7/8"	3-3/4"	1"	1/2"	.20"
AMF43	3/8"	8"	1-1/8"	1-1/2"	2"	4"	1"	1/2"	.20"

## 3 in 1 Manifolds

### Features

- Supplies three air operated tools from a single hose, permitting use of air by more than one mechanic
- Can be mounted to a pipe at workbench or overhead
- Different tools in the shop use different styles of couplers; mount three different style couplers on one manifold



NPT Inlet (1)	NPT Outlets (3)	Aluminum Part #
1/4"	1/4"	D3404
3/8"	1/4"	D3406
1/2"	1/4"	D3408

### Flat Hex Manifolds

**Feature**

- Designed to lay flat on the floor, safely distributing three hose lines to the work area

NPT Inlet (1)	NPT Outlets (3)	Brass Part #
1/4"	1/4"	3122
3/8"	1/4"	3132
3/8"	3/8"	3133

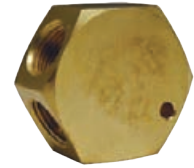

### Compressor Y

**Feature**

- Converts a single supply source to a dual outlet

Female NPT Inlet (1)	Male NPT Outlets (2)	Iron Part #
1"	3/4"	Y10075



**F**

### Anti-Freeze Lubricants

**Application**

- Winter grade air tool lubricant prevents air line, air tool, and in-line lubricator freeze-up

**Features**

- Can be poured directly into tool or used with air line lubricators

**Specification**

- Minimum temperature -45°F (-43°C)

Size	Part #	Optional Qty
1 pint	DATL016W	12
1 gallon	DATL128W	4



Pint

Gallon

### Air Tool Lubricants

**Application**

- High grade lubricant prolongs the service life of air tools, cylinders, and accessories

**Features**

- #10 weight lubricant
- Compound is superior in performance to ordinary lubricants
- Prohibits rust and removes moisture as it lubricates
- Non-corrosive, non-reactive, and does not decompose
- Easy pour spout helps prevent costly spills
- Use with the in-line lubricators on page 268

Size	Part #	Optional Qty
1 pint	DATL016	12
1 gallon	DATL128	4



Pint

Gallon

### In-Line Lubricators

**Features**

- Protects portable or stationary air tools by efficiently oiling the tool mechanisms; each time an air tool is operated a fine mist of oil is injected into it along with the air from the compressor
- Installation is recommended within 25' of the tool to be lubricated, refer to the arrow for proper air flow direction
- Transparent sight disc allows visual inspection of oil level
- Oil flow regulated by screwdriver screw adjustment; minimum flow rate is 30 SCFM
- Not recommended for constant flow applications
- For reciprocating tools only
- Type of oil to use: any petroleum-based, non-detergent light weight oil (SAE 10/150SSU) which will readily break up into a mist, i.e., Mobil DTE light or comparable oil, do not use any synthetic oil or oils containing additives or solvents
- See page 267 for air tool lubricant



F

NPT Size	Oil Capacity	Maximum Working Pressure at ambient temperature (70°F)	Air Flow at 70 PSI	Aluminum Part #
1/2"	1.4 fluid ozs.	500 PSI	30 SCFM	PL300
3/4"	3.7 fluid ozs.	200 PSI	70 SCFM	PL400
3/4"	11.0 fluid ozs.	300 PSI	70 SCFM	PL400L
1"	16.0 fluid ozs.	250 PSI	100 SCFM	PL500

### Replacement Parts

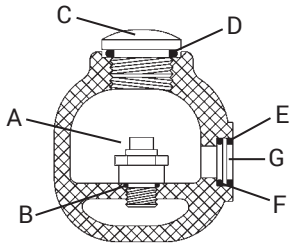

Description	Part #
(A) oil adjustment valve assembly	851661
(B) valve gasket	452531
(C) fill plug	452525
(D) fill plug O-ring	700013-214
(E) sight disk	452532
(F) sight disk seal	700013-016
(G) sight disk lock nut	452533

### In-Line Air Filter

**Features**

- Protects small air tools, such as impact wrenches, nut runners, grinders, and screwdrivers
- All-anodized, compact housing
- Install directly before the air tool
- Male x female configuration
- Standard 40 micron element ensures minimum pressure drop
- Elements can be replaced quickly



**Specifications**

- Maximum operating pressure: 500 PSI
- Temperature range: 35°F to 200°F (2°C to 93°C)
- Air flow: 140 SCFM

Male NPT	Overall Length	Diameter	Aluminum Part #
3/4"	3-13/16"	1-1/2"	9076M

## Disposable In-Line Nipple Filters

### Features

- For filtration of water, oil, and air
- Compact and lightweight
- Can be installed at point of use
- Shape element is conical rather than disc, providing a larger filtering flow and a true, uninterrupted axial flow
- Available in 40 micron or 90 micron

### Specifications

- Maximum operating pressure: **300 PSI**
- Temperature range: **35°F to 300°F (2°C to 148°C)**

Male NPT	Overall Length	Hex	Air Flow	Brass Part #
1/8"	1-1/4"	7/16"	10 SCFM	ASP3101-40
				ASP3101-90
1/4"	1-1/2"	9/16"	20 SCFM	ASP3102-40
				ASP3102-90
3/8"	1-3/4"	11/16"	30 SCFM	ASP3103-40
				ASP3103-90
1/2"	2"	7/8"	50 SCFM	ASP3104-40
				ASP3104-90



F

## In-Line Lubricators with Filters

### Feature

- Consists of 9076M particle filter with 40 micron sintered bronze element and PL400 (3.7 ounce) or PL400L (11.0 ounce) lubricator

NPT Size	Oil Capacity	Max. Working Pressure at ambient temperature 70°F (21°C)	Aluminum Part #
3/4"	3.7 fluid ozs.	<b>200 PSI</b>	PL400WF
	11.0 fluid ozs.	<b>300 PSI</b>	PL400LWF



## Mini In-Line Lubricators

### Features

- Can be refilled under line pressure
- Oil capacity: 1/4 fluid ounce

### Specifications

- Flow rating: 22 SCFM at 100 PSIG
- Maximum operating pressure: 200 PSIG
- Maximum temperature: **150°F (66°C)**

Female NPT Inlet	Outlet	Aluminum Part #
1/4"	1/4" female NPT	ML200
	1/4" male NPT	ML200M
3/8"	3/8" male NPT	ML300M



## Safety Check Valves

### Applications

- Used in temporary plant/factory air lines, construction sites, shipyards, or utilities
- Not for use in applications where 100% of the available air is required, i.e. sand blast, pile driving rigs, expansion joint blow down pipes, etc.



### Features

- High-flow valve provides optimum performance
- Controls excess air flow (SCFM) in only one direction
- Automatically senses change in air flow and shuts off the flow in the event of a surge in excess of valve flow rating thus preventing hose whip
- Does not prevent backflow

### Materials

- Solid brass body and valve
- Stainless steel spring and roll pin

### Specifications

- Conforms to OSHA regulation 1926.302 (b) (7) requiring a safety device at the source of the air supply and at branch air lines
- Maximum operating pressure: **350 PSI**
- Maximum temperature: **250°F (121°C)**

### How It Works

- Safety check valves utilize the pressure differential across the valve to operate the valve and spring assembly. The pressure differential is directly related to the flow of air (SCFM) through the valve.
- When the pressure differential is within the operating limits - below the cutoff flow - of the unit, the force on the valve exerted by the spring is greater than that caused by the pressure differential (see "Open Position" graphic to the right). The valve remains open and normal operation continues.
- When the pressure differential is above the cutoff limit, the force on the valve exerted by the pressure differential is greater than the force exerted by the spring, and the valve closes (see the "Closed Position" graphic to the right).
- After the repair is made, normal operation is automatically enabled when pressure across the valve equalizes through the bleeder hole.
- The valve spring size can be specified by determining the air flow during normal operation and by estimating the air flow if a failure or rupture occurs.

F

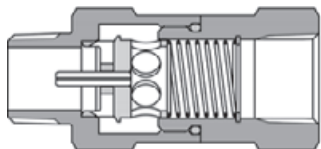
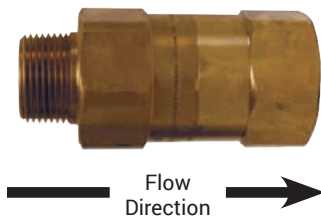

Open Position

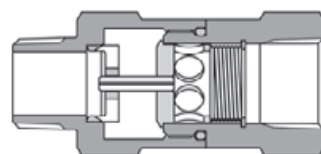

Closed Position

NPT & Hose I.D. Size	Cut-off Flow Rate (SCFM at 90 PSI)	Brass Part #	NPT & Hose I.D. Size	Cut-off Flow Rate (SCFM at 90 PSI)	Brass Part #
1/4"	23-29	SCVL2	1-1/4"	260-290	SCVL10
3/8"	30-36	SCVL3		300-340	SCVM10
	39-47	SCVM3		440-500	SCVS10
1/2"	52-65	SCVS3	1-1/2"	570-630	SCVH10
	70-78	SCVM4		300-360	SCVL12
3/4"	80-96	SCVS4		2"	470-530
	72-88	SCVL6	564-602		SCVX12
1"	92-108	SCVM6	3"		640-720
	112-128	SCVR6		750-830	SCVH12
	132-148	SCVJ6		510-590	SCVL16
	160-180	SCVS6		725-825	SCVM16
1"	180-200	SCVH6	3"	900-1050	SCVS16
	165-195	SCVL8		1100-1200	SCVH16
	220-260	SCVM8		1200-1400	SCVL24
	280-320	SCVS8		2400-2700	SCVS24
	310-340	SCVH8		2850-3050	SCVH24



### Conical Mufflers

**Application**

- Threads into the exhaust ports of air tool, valves, cylinders, and other pneumatic equipment

**Features**

- Reduces noise levels below 90 dBA to conform with OSHA standards
- 40 micron bronze filter element
- Element is bonded directly to the fitting and is not replaceable

**Specifications**

- Maximum operating pressure: **300 PSI**
- Temperature range: **35°F to 300°F (2°C to 149°C)**

NPT Thread	Overall Length	Nickel Plated Steel Part #
1/8"	1-1/8"	CMF18
1/4"	1-3/8"	CMF28
3/8"	1-1/2"	CMF38
1/2"	1-7/8"	CMF48
3/4"	2-1/4"	CMF68
1"	2-7/8"	CMF88



F

### Speed Control Mufflers

**Features**

- Safe and infinite variations of metering air flow at acceptable sound levels on exhaust ports of air valves
- Speed of operating cylinder or air tool may be increased or decreased with adjusting screw; the final position is locked in place by the lock nut
- Exhaust air noise is eliminated by a surrounding sleeve of sintered bronze

**Specifications**

- Maximum operating pressure: **300 PSI**
- Temperature range: **35°F to 300°F (2°C to 149°C)**

NPT Thread	Approximate Full Oper. Height	Maximum Adjusted SCFM	Brass Part #
1/8"	1-5/16"	20	SCM18
1/4"	1-9/16"	30	SCM28
3/8"	1-5/8"	40	SCM38
1/2"	2"	60	SCM48
3/4"	2-3/8"	70	SCM68
1"	2-1/2"	100	SCM88



Aluminum

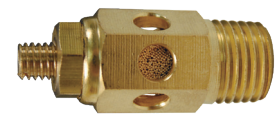

Brass

### Breather Vents

**Applications**

- Used on single-acting cylinders or valves to prevent dirt and foreign particles from entering ports open to the atmosphere
- Provides vacuum relief or pressure equalization on gear boxes, oil tanks, or reservoirs

**Features**

- Standard pipe thread connections for quick assembly and removal for cleaning
- Nickel plated steel insert with a bronze filter
- 40 micron filter element

**Specifications**

- Maximum operating pressure: **150 PSI**
- Temperature range: **35°F to 300°F (2°C to 148°C)**

NPT Thread	Overall Length	Nickel Plated Steel Part #
1/8"	7/16"	ASP-1BV
1/4"	5/8"	ASP-2BV
3/8"	3/4"	ASP-3BV
1/2"	7/8"	ASP-4BV
3/4"	1"	ASP-6BV
1"	1-5/16"	ASP-8BV



## Super Quiet Flow Economy Pneumatic Silencers / Mufflers

**Features**

- Design incorporates a 50 mesh, self-cleaning, stainless steel screen in a strong, protective glass-filled nylon housing which is ultrasonically welded for maximum strength

**Specifications**

- Maximum operating pressure: **300 PSI**
- Temperature range: **35°F to 120°F (2°C to 49°C)**



NPT Thread	Overall Length	Diameter	Part #
1/8"	2-7/16"	13/16"	SQF-1
1/4"	2-15/64"	13/16"	SQF-2
3/8"	3-27/64"	1-1/4"	SQF-3
1/2"	3-35/65"	1-1/4"	SQF-4

### Dixon® Keychain

**Feature**

- Halves separate like a coupler and plug



**Plated Steel**

**Part #**

DKC1

### Mini In-Line Filter

**Features**

- Either port may be used as an inlet port
- Filter element rated at 5 microns

**Specifications**

- Flow rating: 17 SCFM inlet pressure at 100 PSIG
- Maximum operating pressure: 200 PSIG  
maximum temperature: **175°F (79°C)**



Female NPT	Male NPT	Aluminum Part #
1/4"	1/4"	MF200

## Series 1 Non-Repairable General Purpose Regulators

**Features**

- Relieving piston allows reduction of downstream pressure when system is dead-ended
- Left to right flow
- Compact design and light weight construction
- Wrench flats for easy installation
- Supplied with a GC620 gauge, sold separately on page 345

**Specifications**

- 5 to 125 PSIG outlet pressure adjustment range
- Reliable pressure regulation at air flows up to 13 SCFM



Female NPT	With Gauge Part #	Without Gauge Part #
1/4"	R46-200RG	R46-200R

F

## Needle Valves

### Features

- Metal-to-metal seats allow positive sealing and flow adjustment
- Designed for air and water applications

### Specification

- Maximum working pressure: **150 PSI** at ambient temperature **70°F (21°C)**

#### Female x Female

Female NPT	Female NPT	Brass Part #
1/8"	1/8"	NV2F
1/4"	1/4"	NV4F



#### Male x Male

Male NPT	Male NPT	Brass Part #
1/4"	1/4"	NV4M

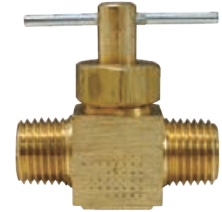

F

## Mini In-Line Disposable Desiccant Dryer

### Application

- Ideal for spray guns (point-of-use); attaches directly to spray gun or mini regulator located on spray gun

### Features

- Unit is bi-directional 1/4" NPT
- 40 micron, porous bronze element removes fine dirt particles, as oil-removing media removes oil vapor and desiccant bead absorbs water vapor

### Specifications

- Working pressure: **125 PSI**
- Blue desiccant beads lower the dew point to **-40°F (-40°C)** and remove water vapor; bead color turns pink when it is time to replace filter/dryer



Male NPT	Female NPT	Flow (SCFM)	Description	Part #
1/4"	1/4"	15	package of 2	DFD-10

### Valves

#### Button



Thread	Brass Part #
1/4" NPT female	BV2F
1/4" NPT male	BV2M

#### Tank Filler

##### Applications

- Used on compressed air tanks and other applications

##### Feature

- Standard valve stem thread



TFV1S

TFV2



TFV1L

TFV2HB

Connection	Length	Nickel Plated Part #	Length	Brass Part #
1/8" NPT	.85"	TFV1S	---	---
	1.24"	TFV1L	---	---
1/4" NPT	1"	TFV2	---	---
1/4" barb	---	---	1.57"	TFV2HB

### Brass Lever External Drains

##### Application

- For air service only

##### Specification

- Maximum operating pressure: **30 PSI** at ambient temperature **70°F (21°C)**

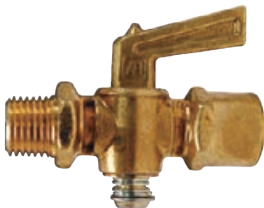

Female NPT	Male NPT	Brass Part #
1/4"	1/4"	LDC2

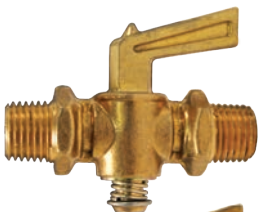

Male NPT	Male NPT	Brass Part #
1/4"	1/4"	LDCM2



Female NPT	Female NPT	Brass Part #
1/4"	1/4"	LDCF2

### Brass External Drain Cocks

##### Application

- Designed for low pressure water and air applications

##### Specification

- Maximum operating pressure: **150 PSI** at ambient temperature **70°F (21°C)**



NPT Size	Brass Part #
1/8"	D02
1/4"	D04

F

## Safety Pop-Off Valves

### Applications

- For use on compressors and in compressed air service

### Feature

- Designed to protect un-fired pressure vessels from over-pressure

### Specifications

- ASME Code, National Board Certified
- CSA B51-03 certified
- Maximum temperature: 400°F (204°C)

### Soft Seat

#### Feature

- Constructed of precision machined brass bar stock with a silicone disc sealing on the brass

Male NPT	Preset Pressure PSI	SCFM	Brass Part #
1/4"	100	51	KSV10-100
	125	62	KSV10-125
	150	73	KSV10-150
	175	84	KSV10-175



F

### Standard

#### Features

- Brass valves are supplied with a stainless steel ball
- Stainless valves are all stainless construction with a soft seat

Male NPT	Preset Pressure PSI	SCFM	Brass Part #	SCFM	Stainless Steel Part #
1/4"	30	35	SV30	35	SV30SS
	100	89	SV100	92	SV100SS
	125	109	SV125	112	SV125SS
	150	129	SV150	132	SV150SS
	175	149	SV175	153	SV175SS
	200	168	SV200	173	SV200SS



### Heavy Duty, High Capacity

#### Feature

- All brass construction with stainless steel ball on a precision machined brass seat

Male NPT	Preset Pressure PSI	SCFM	Brass Part #
1/2"	30	73	SV30HD <sup>1</sup>
	100	208	SV100HD
	125	254	SV125HD
	150	300	SV150HD
	175	346	SV175HD
	200	391	SV200HD



<sup>1</sup> Constructed with soft seat

## Flow Control Valves

### Brass Series-F

#### Features

- Provides precision flow control and full shutoff in one flow direction; automatically allows unrestricted flow in the opposite direction
- Two-step needle for fine adjustments at low flow with first three turns of the adjusting knob; next three turns give full-open needle position and conventional throttling control
- When flow is reversed the heavy-duty poppet/retainer permits full flow return capacity
- Color coded scale simplifies flow setting, resetting, adjusting, and return to an original flow
- A set screw locks the valve on any desired setting

#### Specifications

- Maximum operating pressure: **2,000 PSI** at ambient temperature **70°F (21°C)** for sizes 1/8" - 3/4", **500 PSI** at ambient temperature **70°F (21°C)** for 1"



F

Female NPTF	Brass Part #
1/8"	BFC200
1/4"	BFC400
3/8"	BFC600
1/2"	BFC800
3/4"	BFC1200
1"	BFC1600

### Brass Series-N

#### Features

- For use as speed control on hydraulic and pneumatic systems where a reverse flow check valve is not needed
- Provides excellent control and reliable shutoff in a very small envelope
- Color coded scale simplifies setting, resetting, adjusting, and quick return to a previous speed setting

#### Specifications

- Maximum operating pressure: **2,000 PSI** at ambient temperature **70°F (21°C)** for sizes 1/8" - 3/4", **500 PSI** at ambient temperature **70°F (21°C)** for 1"



Female NPTF	Brass Part #
1/8"	BN200
1/4"	BN400
3/8"	BN600
1/2"	BN800
3/4"	BN1200
1"	BN1600

## Series-C Check Valves

#### Feature

- Provides free flow in one direction and dependable shutoff in the opposite direction

#### Specifications

- Maximum operating pressure: **2,000 PSI** at ambient temperature **70°F (21°C)**
- Cracking pressure: **5 PSI**



brass



steel

Female NPT	Free Flow GPM	Maximum Operating PSI at 70°F (21°C)	Brass Part #	Maximum Operating PSI at 70°F (21°C)	Steel Part #
1/8"	3	<b>2,000</b>	BCV200	<b>5,000</b>	SCV200
1/4"	5	<b>2,000</b>	BCV400	<b>5,000</b>	SCV400
3/8"	8	<b>2,000</b>	BCV600	<b>5,000</b>	SCV600
1/2"	15	<b>2,000</b>	BCV800	<b>5,000</b>	SCV800

## Safety Blow Guns

Safety blow guns have a safety tip that prevents buildup of tip pressure in the event the outlet is obstructed or "dead ended." They comply with the requirements for OSHA 1910.242 (B) and 1910.95 when used on air lines of **150 PSI** or less.



### Features

- Design comfortably fits contour of the hand, minimizing user fatigue
- Ergonomic large lever with black vinyl grip allows for easy air flow activation
- 1/4" female NPT inlet

### Air Chief

The air chief safety blow gun is designed to conform to OSHA Standard 1910.242 (B) permitting a maximum of **30 PSI** outlet pressure when dead ended based on a maximum of **150 PSI** inlet pressure as well as OSHA Standard 1910.95 regulating occupational noise level exposure. Safety glasses or shield must be worn when using any blow gun.



### Features

- Recessed internal slotted screw allows easy access to valve assembly for repairs or replacement
- Chrome plated zinc die cast body, nickel plated steel lever, vinyl thumb grip, stainless steel spring, brass valve, nitrile rubber seals, and nickel plated brass tip combine for superior corrosion resistance



F

---

#### Part #

D204-30

### Premium

The premium safety blow gun is designed to conform to OSHA Standard 1910.242 (B) permitting a maximum of **30 PSI** outlet pressure when dead ended based on a maximum of **150 PSI** inlet pressure as well as OSHA Standard 1910.95 regulating occupational noise level exposure. Safety glasses or shield must be worn when using any blow gun.



### Features

- Zinc die cast body with a black powder coat finish, nickel plated steel lever, vinyl thumb grip, stainless steel spring, brass valve, nitrile rubber seals, and nickel plated brass tip



---

#### Part #

D204-30P

### Air Booster

The multiple holes in the safety booster tip of the safety air booster gun create a Venturi effect that increases air flow (working capacity) while still remaining compliant with OSHA Standard 1910.242 (B). Safety glasses or shield must be worn when using any blow gun.



### Features

- Chrome plated zinc die cast body, nickel plated steel lever, vinyl thumb grip, stainless steel spring, brass valve, nitrile rubber seals, and nickel plated brass tip provide superior corrosion resistance



---

#### Part #

D204-30SB

### Pistol Grip



**Features**

- Contoured pistol-grip for safe, comfortable handling, even with greasy hands
- Convenient hang-up hook
- 1/4" female NPT inlet
- Safety glasses or shield must be worn when using any blow gun 

**Specifications**

- Conforms to US Department of Labor, OSHA Standard 1910.242 (B) allowing a maximum of **30 PSI** outlet pressure at the nozzle when dead-ended
- Conforms to US Department of Labor, OSHA Standard 1910.95 regulating noise level exposure

---

**Part #**

PG700

### Extended Nozzle Pistol Grip



**Features**

- Variable output trigger enables user to control air flow
- Hook design near trigger provides finger protection as well as easy storage
- Lightweight to help minimize user fatigue.
- Side holes allow air to escape if nozzle tip is dead-ended, thus preventing back pressure buildup
- 1/4" female NPT inlet
- Safety glasses or shield must be worn when using any blow gun. 

**Specifications**

- Conforms to US Dept. of Labor, OSHA Standard 1910.242 (B) allowing a maximum of **30 PSI** outlet pressure at the nozzle when dead-ended
- Conforms to US Dept. of Labor, OSHA Standard 1910.95 regulating noise level exposure
- Slender 4" extended nozzle allows access to hard to reach places and holes as small as .200"
- Pressure rating: **150 PSI**

---

**Part #**

ENBG1

### Safety Tip

**Features**

- 1/8" male NPT connection
- Can be used with all Dixon® Air Chief lever operated blow guns as well as most blow guns from other manufacturers



---

**Nickel Plated Brass**

**Part #**

SST10

### Rubber Non-Safety Tip

**Features**

- 1/8" male NPT connection
- Can be used with all Dixon Air Chief lever operated blow guns as well as most blow guns from other manufacturers



---

**Rubber Coated Nickel Plated Brass**

**Part #**

D201RT

F



## Non-Safety Blow Guns

Non-Safety blow guns do not have a safety by-pass to prevent buildup of tip pressure in the event of tip blockage. They may be used for cleaning purposes only if the air supply (inlet pressure) has been reduced to **30 PSI** or less.



### Features

- Designed to comfortably fit the contour of the hand, minimizing user fatigue
- Ergonomic large lever with vinyl grip allows for easy air flow activation
- 1/4" female NPT inlet

## Brass Tip

The ventless, nickel-plated tip provides the most economical means of achieving a concentrated stream of air for many blow-off applications. All other components and design features are the same as our Air Chief safety blow gun (D204-30). Must be used on air lines having a maximum regulated pressure of **30 PSI** in order to comply with OSHA Standard 1910.242 (B). Safety glasses or shield must be worn when using any blow gun.



### Feature

- Chrome plated zinc die cast body, nickel plated steel lever, vinyl thumb grip, stainless steel spring, brass valve, nitrile rubber seals, and ventless, nickel plated brass tip provide superior corrosion resistance



F

---

### Part #

D605

## Rubber Tip

The rubber tip will not scratch or mar delicate surfaces. The conical, rubber tip can also be used to create a seal between the blow gun and fluid lines (or any other opening). Base of the tip is nickel-plated brass for additional corrosion resistance. Must be used on air lines having a maximum regulated pressure of **30 PSI** in order to comply with OSHA Standard 1910.242 (B). Safety glasses or shield must be worn when using any blow gun.



### Feature

- Chrome plated zinc die cast body, nickel plated steel lever, vinyl thumb grip, stainless steel spring, brass valve, nitrile rubber seals, and rubber tip with a nickel plated brass base provide superior corrosion resistance



---

### Part #

D201

## Extensions

### Features

- Supplied with 1/8" male NPT connections
- Allow easier access to blow-off applications in high or hard to reach places
- Can be used with all Dixon® Air Chief lever operated blow guns as well as most blow guns from other manufacturers
- Brass base with a rugged steel extension tube, all nickel plated

Size Extension	Part #
6"	BGE6
10"	BGE10
12"	BGE12
18"	BGE18
24"	BGE24



## Heavy Duty - High Volume Safety Blow Guns

### Features

- Heavy duty - high volume safety blow guns
- Requires high volume coupler and plug for optimum performance
- Lightweight and ergonomic
- Pistol grip / hanging hook handle
- Made from high quality aluminum casting
- 1/4" female NPT inlet
- Safety glasses or shield must be worn when using any blow gun.



### Specification

- Maximum operating pressure: **150 PSI**

## Heavy Duty - High Volume with Safety Tip

### Features

- Reduced to **30 PSI** when tip is blocked
- The safety air booster blow gun has a safety tip which prevents buildup of tip pressure in the event the outlet obstructed or "dead ended," it complies with the requirements for OSHA 1910.242 (B) and 1910.95 when used on air lines of **150 PSI** or less



HTBG6

Description	Part #
gun with no extension	HTBG
gun with 6" extension	HTBG6
gun with 12" extension	HTBG12
gun with 24" extension	HTBG24
gun with 36" extension	HTBG36

## Heavy Duty - High Volume with Quiet Conical Tip

### Specification

- 6.0 CFM



Description	Part #
gun with tip only	HTBG-CT

### Accessories



HTBGC

Female NPT Inlet (1)	Aluminum Part #	Brass Part #
6" extension with safety tip	HTBG6EXT	---
12" extension with safety tip	HTBG12EXT	---
24" extension with safety tip	HTBG24EXT	---
36" extension with safety tip	HTBG36EXT	---
safety tip	HTBGS	---
conical tip	HTBGC	---
tip adapter	HTBGA	---
high flow female coupler	---	2CJF2-B
high flow male plug	---	CJ2M2-B

## High Volume Typhoon Blow Guns

### Features

- Chrome plated aluminum body
- Variable flow control
- 1/4" female NPT inlet

### Specification

- 34 CFM at **125 PSI**
- Compliant with OSHA Standard 1910.242 (B). Safety glasses or shield must be worn when using any blow gun.



Description	Part #
gun with no extension	TYP2501
gun with 6" extension	TYP2501-6
gun with 12" extension	TYP2501-12
gun with 24" extension	TYP2501-24
gun with 36" extension	TYP2501-36

## High Volume Cannon® Blow Gun

### Application

- Designed for, but not limited to, outdoor use, ideal where a large air supply is available to move heavy, stubborn debris

### Features

- 3/4" female NPT inlet
- 48" long extension
- Safety glasses or shield must be worn when using any blow gun.



### Specifications

- Minimum inlet pressure **90 PSI** on 1/2" hose
- Consumes 135 CFM at **100 PSI**
- Compliant with OSHA Standard 1910.242 (B)

Part #
9000-48S

## Coil-Chief Self-Storing Air Hose

### Hose - Fittings Included

**Feature**

- Supplied with swivel on one end



Hose I.D.	Length	Male NPT	Working Pressure @ 70°F (21°C)	Nylon Part #
1/4"	12'	1/4"	185	CC1412
	25'	1/4"	185	CC1425
	50'	1/4"	185	CC1450
3/8"	25'	3/8"	165	CC3825
	50'	3/8"	165	CC3850
1/2"	25'	1/2"	170	CC1225
	50'	1/2"	170	CC1250

### Bulk Hose - No Fittings

**Feature**

- Need assembly kits below for ends



Hose I.D.	Length	Nylon Part #
1/4"	100'	CC14100B
3/8"	100'	CC38100B
1/2"	100'	CC12100B

### Assembly Kits

**Feature**

- Kit includes: fittings, nut, insert, ferrule, and spring guard



RK110 assembly kit

Size	Fitting Type	Part #
1/4"	rigid male	RK090
	swivel male	RK092
3/8"	rigid male	RK110
	swivel male	RK112
1/2"	rigid male	RK118
	swivel male	RK119

## Polyurethane Air Hose (fittings included)

**Features**

- Durable and lightweight
- Nylon-reinforced braid allows for higher working pressure
- Excellent flexibility
- Oil resistant
- Durometer: Shore A 85



**Specifications**

- Temperature range: -40°F to 155°F (-40°C to 68°C)
- Working pressure: 210 PSI at 70°F (21°C)

Hose I.D.	Length	Male NPT	Polyurethane Part #
1/4"	50'	1/4"	450-4S
3/8"	50'	1/4"	650-4S
	50'	3/8"	650-6S

### Polyurethane Self-Storing Air Hose (fittings included)

**Features**

- Extremely flexible - resists kinking
- Impervious to abrasions, heat and oil
- Superior elasticity and coil memory
- Both ends swivel

Hose I.D.	Length	Male NPT	Working Pressure (PSI)	Polyurethane Part #
1/4"	10'	1/4"	145	PU1410
	15'	1/4"	145	PU1415
	25'	1/4"	145	PU1425
3/8"	15'	3/8"	135	PU3815
	20'	3/8"	135	PU3820
	25'	3/8"	135	PU3825
	50'	3/8"	135	PU3850
1/2"	15'	1/2"	155	PU1215



F

#### Repair Kits

Size	Tubing Size		Type	Brass Part #
	I.D.	O.D.		
1/4"	1/4"	3/8"	swivel male	PSM0404
	3/8"	9/16"	swivel male	PSM0604



### Polyurethane Air Hose with Strain Relief Fittings

**Application**

- Metal-working or wood-working operations, in which product shavings or sawdust often make it difficult to view the work surface

**Features**

- Male NPT
- Kinking with polyurethane resin
- Built-in industrial coupler blow gun
- Works with tool connected or disconnected

**Materials**

- Air hose: polyurethane
- Blow gun: brass and plated steel

Hose I.D.	Length	Male NPT	Working Pressure (PSI) @ 70°F (21°C)	Polyurethane Part #
1/4"	25'	1/4	120	PU1425-CBG



### Industrial Coupler Blow Gun

**Application**

- This convenient unit is perfect for metalworking or woodworking operations, in which product shavings or sawdust often make it difficult to view the work surface

**Features**

- Already on your hose and ready to use
- Easy push button trigger
- 1/4" ARO with 1/4" female NPT
- Works with tool connected or disconnected
- Safety glasses or shield must be worn when using any blow gun.



**Materials**

- Blow gun: brass and plated steel



Female NPT	Part #
1/4"	CBG25

### Heavy Duty Tire Pressure Gauge



**Features**

- 12" hose with swivel dual foot chuck inflator
- Tapered chuck nut fits wheel cover holes on cars and light trucks
- Calibrated in 2 PSI increments from 10 to 120 PSI

Part #

D101

### Passenger Car Tire Pressure Gauge



**Features**

- 12" hose with straight-on chuck
- Straight chuck nut fits wheel cover holes on cars and light trucks
- Ideal for use on wells and reels
- Calibrated in 2 PSI increments from 10 to 90 PSI

Part #

D150

### Professional Tire Pressure Gauge



**Features**

- Pre-lubricated
- Easy to read, dual calibrated (PSI and kPa), four-sided nylon indicator bar
- Body is made of chrome-plated brass, head is chrome-plated zinc
- Pocket clip
- Calibrated in 1 PSI increments from 5 to 45 PSI

Part #

DFG5

### Dual Foot Tire Pressure Gauges



**Features**

- Handy pocket clip
- Calibrated in 2 PSI increments from 20 to 120 PSI

Part #

DFG1



**Features**

- Heavy duty hang-up ring
- Calibrated in 2 PSI increments from 10 to 150 PSI

Part #

DFG2

### Tire Inflator Chuck



**Features**

- Ball foot chuck
- For direct connection to live air only
- Features a built-in shutoff valve (will not work on inflator gauges)
- 1/4" NPT female thread

**Specifications**

- Maximum pressure is 150 PSI

Brass  
Part #

D104

Optional Qty

10

## Ball Swivels

### Features

- Brass and hardened steel construction
- O-ring seals
- Wobble action for increased flexibility with air driven tools

Hose Size	Male NPT	Part #	Optional Qty
1/4"	1/4"	D444S	25
3/8"	1/4"	D446S	25



## In-Line Swivels

### Features

- For air service only 
- Heavy-duty, free turning steel swivel

### Specification

- Rated to **250 PSI** at ambient temperature 70°F (21°C), minimum 35 PSI

Male NPT	Female NPT	Steel Part #
3/8"	1/2"	SV17
1/2"	1/2"	SV20
3/4"	3/4"	SV26



### Feature

- For air service only 

### Specification

- Rated to **150 PSI** at ambient temperature 70°F (21°C)

Male NPT	Female NPT	Brass Part #
1/4"	1/4"	D344R
3/8"	3/8"	D366R

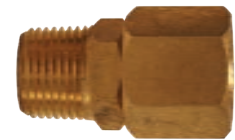

## Air Tool Swivels

### Features

- Swivels at two locations so air hose can drop directly to the floor
- Do not use with percussion tools 

### Specification

- Rated to **150 PSI** at ambient temperature 70°F (21°C)

Size	Aluminum Part #
1/4"	D344U <sup>1</sup>
3/8"	D346U
1/2"	D348U



<sup>1</sup> D344U is a non-marring composite.

## Reelcraft® 5000 Series Spring Driven Hose Reels

### Features

- Reel inlet 3/8" NPTF
- All steel construction
- Full shaft and swivel
- Supplied standard with PVC hose
- Compressed air hose should not be converted to oxygen service; they are often contaminated with an oil coating, which can react explosively when oxygen is introduced



### Specification

- Maximum temperature: 150°F (66°C)

#### With Hose

Hose I.D.	Hose Length	Service	Working Pressure PSI	Part #
1/4"	50'	air / water	300	5450LP
3/8"	35'	air / water	300	5635LP
	50'	air / water	300	5650LP

#### Without Hose

Hose Capacity	Service	Working Pressure PSI	Part #
50' of 1/4" or 35' of 3/8"	air / water	500	5600LP
50' of 3/8"	air / water	500	5605LP



F

## Reelcraft® 7000 Series Spring Driven Hose Reels

### Features

- All steel construction
- LP Low Pressure reels:
  - maximum temperature 150°F (66°C)
  - reel inlet 1/2" NPTF
  - PVC hose is standard
- MP Medium Pressure reels:
  - maximum temperature 210°F (99°C)
  - reel inlet 1/2" NPTF
  - SAE 100 R1T 1-wire braid hose available
- HP High Pressure reels:
  - maximum temperature 210°F (99°C)
  - reel inlet 1/4" NPTF
  - SAE 100 R2T 2-wire braid hose available

#### With Hose

Hose I.D.	Hose Length	Service	Working Pressure PSI	Part #
3/8"	70'	air / water	300	7670LP
1/2"	50'	air / water	300	7850LP

#### Without Hose

Hose Capacity	Service	Working Pressure PSI	Part #
70' of 3/8", 50' of 1/2"	air / water	500	7800LP
50' of 3/8" or 50' of 1/2"	oil	3000	7800MP
50' of 1/4" or 50' of 3/8"	grease	5000	7600HP





## Reelcraft® 80000 Series Spring Driven Hose Reels

### Features

- Reel inlet 3/4" NPTF
- Five-in-one heat treated aluminum casting incorporates main shaft, ratchet, spring arbor, and inlet/outlet plumbing in one-piece casting
- Furnished standard with PVC hose

### Specifications

- Maximum temperature is 150°F (66°C) with hose
- Maximum temperature is 210°F (99°C) without hose

#### With Hose

Hose I.D.	Hose Length	Service	Working Pressure PSI	Part #
1/2"	75'	air / water	300	82075LP
	100'	air / water	300	82100LP
3/4"	50'	air / water	250	83050LP

#### Without Hose

Hose Capacity	Service	PSI	Part #
50' of 3/4" or 100' of 1/2"	air / water	500	83000LP



See below for bumper stops, consult Dixon® for uses other than stated services

F

### Adjustable Hose Bumper Stops

Hose I.D.	Hose O.D.		Dimensions		Reel Series Used On	Part #
	From:	To:	B,C,E	D		
1/4"	.438"	.625"	2-1/2"	1-1/4"	5000	1-HR1004A
3/8"	.625"	.749"	2-1/2"	1-1/4"	5000	1-HR1004
3/8"	.625"	.749"	3"	1-1/4"	7000	1-HR1004-3
1/2" or 3/8" 2-wire	.750"	1.050"	3"	1-1/4"	7000	2-HR1004-3
3/4"	1.060"	1.300"	3"	1-1/4"	7000	3-HR1004-3
1/2"	.750"	1.050"	3-1/2"	2-7/8"	9000	2-HR1005
3/4"	1.060"	1.380"	3-1/2"	2-7/8"	9000	3-HR1005
1"	1.390"	1.550"	3-1/2"	2-7/8"	9000	4-HR1005

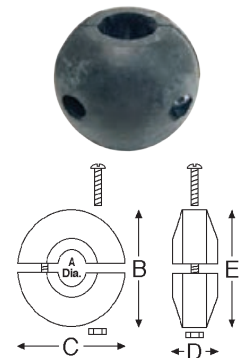

NOTE: Not included on hose reels ordered without hose; must order separately

## Reelcraft® 30000 Manual Driven Hose Reels

### Features

- Reel frame, spool, and drum are fabricated from heavy gauge steel
- All bolted construction - no welds
- Manual driven standard
- Motor drive available

#### Without hose

Hose I.D.	Inlet	Hose Capacity	Spool Width	Working Pressure PSI	Part #
3/4"	3/4"	100'	12"	1000	C33112L
1/2"	1/2"	200'	12"	3000	C32112M



## Wilkerson FRLs

### F03-Series Miniature Filters

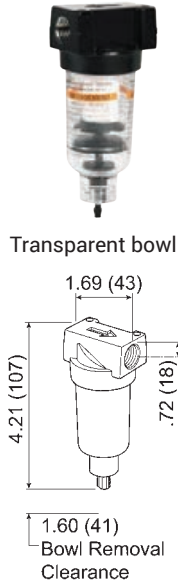

#### Features

- Excellent water removal efficiency
- 5 micron element
- .5 oz. bowl

#### Specifications

- Maximum operating conditions:
  - transparent bowl: 150 PSIG (10.3 bar) and 32°F to 125°F (0°C to 52°C)
  - metal bowl: 250 PSIG (17.2 bar) and 32°F to 175°F (0°C to 80°C)

Port Size	Flow (SCFM)	Transparent Bowl		Metal Bowl	
		Automatic Drain Part #	Manual Drain Part #	Automatic Drain Part #	Manual Drain Part #
1/8"	22	F03-01A	F03-01M	F03-01AMB	F03-01MMB
1/4"	24	F03-02A	F03-02M	F03-02AMB	F03-02MMB

NOTE: SCFM ratings at 90 PSIG inlet pressure.

### F08-Series Miniature Filters

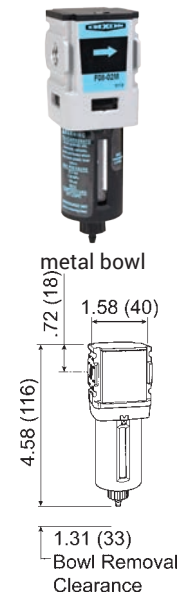

#### Features

- 5 micron element
- .6 oz. bowl

#### Specifications

- Maximum operating conditions:
  - transparent bowl: 150 PSIG (10.3 bar) and 14°F to 125°F (-10°C to 52°C)
  - metal bowl: 250 PSIG (17.2 bar) and 14°F to 150°F (-10°C to 65.5°C)

Port Size	Flow (SCFM)	Transparent Bowl and Guard		Metal Bowl	
		Automatic Drain Part #	Manual Drain Part #	Automatic Drain Part #	Manual Drain Part #
1/4"	42	F08-02A	F08-02M	F08-02AMB	F08-02MMB

NOTE: See pages 312 - 316 for accessories. SCFM ratings at 150 PSIG inlet pressure.

### R03-Series Miniature Regulators



#### Features

- 2-125 PSI adjusting range
- Balanced valve design
- Self-relieving standard
- Non-rising push/pull locking adjustment knob
- Two 1/8" NPT gauge ports standard on models without gauge, one 1/8" NPT gauge port standard on models with gauge - can be used for additional outlet ports
- Models supplied without gauge use a GC620 gauge
- Panel mount nuts sold separately

#### Specifications

- Maximum operating conditions: 300 PSIG (20.17 bar) and 32°F to 125°F (0°C to 52°C)

Size	Flow (SCFM)	With Gauge Part #	Without Gauge Part #
1/8"	13	R03-01RG	R03-01R
1/4"	15	R03-02RG	R03-02R

NOTE: See pages 312 - 316 for accessories.

SCFM ratings at 100 PSIG inlet pressure.

FRLs are designed for air service only, unless otherwise indicated.



### Wilkerson FRLs R08-Series Miniature Regulators

**Features**

- 0-125 PSI adjusting range
- Balanced valve design
- Self-relieving standard
- Non-rising push/pull locking adjustment knob
- Two 1/8" NPT gauge ports standard on models without gauge, one 1/8" NPT gauge port standard on models with gauge - can be used for additional outlet ports.
- Models with gauge are supplied with a 0-160 flush mount style gauge
- Models supplied without gauge use a GC620 gauge.
- Panel mount nuts sold separately

**Specifications**

- Maximum operating conditions:  
300 PSIG (20.7 bar) and -4°F to 150°F (-20°C to 65.5°C)

Size	Flow (SCFM)	With Gauge Part #	Without Gauge Part #
1/4"	68	R08-02RG	R08-02R

NOTE: SCFM ratings at 100 PSIG inlet pressure.



### RB3-Series Miniature Water Regulators

**Features**

- 2-125 PSI adjusting range
- Suitable for water and compressed air service
- Brass construction - wetted parts
- Non-relieving spring-loaded diaphragm
- Panel mount nut included
- Two 1/8" NPT gauge ports standard
- Models supplied without gauge use a GC620 gauge

**Specifications**

- Maximum operating conditions:  
300 PSIG (20.7 bar) and 40°F to 125°F (4°C to 52°C)

Size	Flow (SCFM)	With Gauge Part #	Without Gauge Part #
1/8"	11	RB3-01RG	RB3-01R
1/4"	14	RB3-02RG	RB3-02R

NOTE: See pages 312 - 316 for accessories.  
SCFM ratings at 100 PSIG inlet pressure.

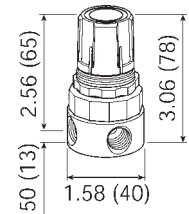

### BB3-Series Miniature Filters / Regulators

**Features**

- 2-125 PSI adjusting range
- 5 micron element
- .5 oz. bowl
- Self-relieving
- Supplied with a GC620 gauge

**Specifications**

- Maximum operating conditions:  
- transparent bowl: 125 PSIG (8.6 bar) and 40°F to 125°F (4.4°C to 52°C)  
- metal bowl: 300 PSIG (20.7 bar) and 40°F to 125°F (4.4°C to 52°C)

Port Size	Flow (SCFM)	Transparent Bowl		Metal Bowl	
		Automatic Drain Part #	Manual Drain Part #	Automatic Drain Part #	Manual Drain Part #
1/8"	13	BB3-01AG	BB3-01MG	BB3-01AGMB	BB3-01MGMB
1/4"	16	BB3-02AG	BB3-02MG	BB3-02AGMB	BB3-02MGMB

NOTE: SCFM ratings at 150 PSIG inlet pressure.

NOTE: FRLs are designed for air service only, unless otherwise indicated.

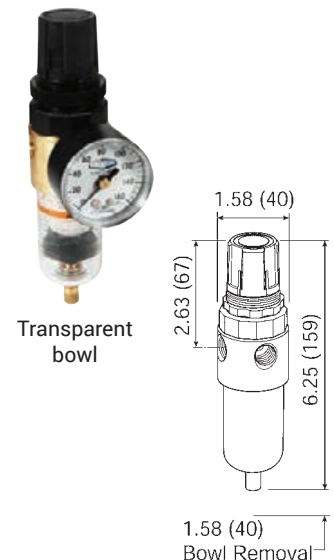

## Wilkerson FRLs

### B08-Series Miniature Filters / Regulators

#### Features

- 0-125 PSI adjusting range
- 5 micron element
- .4 oz. bowl
- Self-relieving
- Supplied with a 0-160 PSI flush mount style gauge

#### Specifications

- Maximum operating conditions:
  - transparent bowl: 150 PSIG (10.3 bar) and 14°F to 125°F (-10°C to 52°C)
  - metal bowl: 250 PSIG (17.2 bar) and 14°F to 150°F (-10°C to 65.5°C)

Size	Flow (SCFM)	Transparent Bowl and Guard		Metal Bowl	
		Automatic Drain Part #	Manual Drain Part #	Automatic Drain Part #	Manual Drain Part #
1/4"	73	B08-02AG	B08-02MG	B08-02AGMB	B08-02MGMB

NOTE: See pages 312 - 316 for accessories.  
SCFM ratings at 100 PSIG inlet pressure.

### L03-Series Miniature Lubricators

#### Features

- 1 oz. bowl
- Adjustable oil feed
- Full view sight dome
- Do not fill under pressure, air supply must be turned off and pressure bled from unit prior to adding oil



#### Specifications

- Maximum operating conditions:
  - transparent bowl: 150 PSIG (10.3 bar) and 32°F to 125°F (0°C to 52°C)
  - metal bowl: 250 PSIG (17.2 bar) and 32°F to 175°F (0°C to 80°C)

Size	Flow (SCFM)	Transparent Bowl Part #	Metal Bowl Part #
1/8"	20	L03-01A	L03-01AMB
1/4"	20	L03-02A	L03-02AMB

NOTE: SCFM ratings at 90 PSIG inlet pressure.

### L08-Series Miniature Lubricators

#### Features

- .6 oz. bowl
- Adjustable oil feed
- Full view sight dome
- Fill under pressure design

#### Specifications

- Maximum operating conditions:
  - transparent bowl: 150 PSIG (10.3 bar) and 14°F to 125°F (-10°C to 52°C)
  - metal bowl: 250 PSIG (17.2 bar) and 14°F to 150°F (-10°C to 65.5°C)

Size	Flow (SCFM)	Transparent Bowl Part #	Metal Bowl Part #
1/4"	52	L08-02A	L08-02AMB

NOTE: See pages 312 - 316 for accessories.  
See page 267 for air tool lubricant.  
SCFM ratings at 150 PSIG inlet pressure.  
FRLs are designed for air service only, unless otherwise indicated.

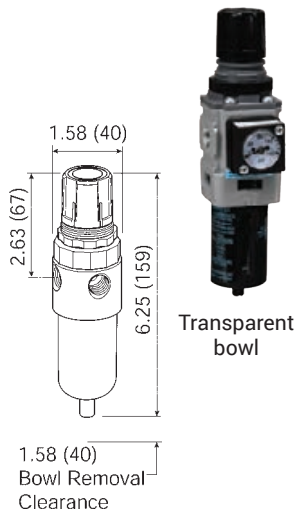

Transparent bowl

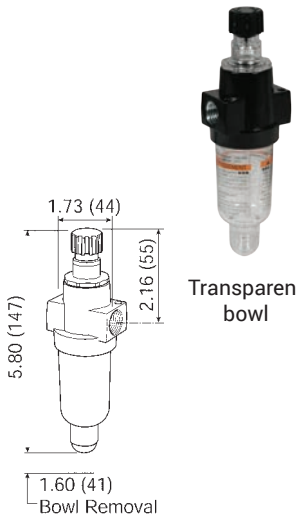

Transparent bowl

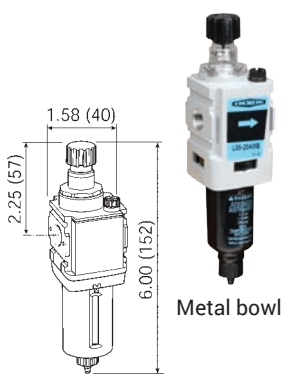

Metal bowl

F

### Wilkerson FRLs C03-Series Miniature Combination Units

**Features**

- Included components: (2) adapters
- Filter series F03:
  - 5 micron element
  - .5 oz. bowl
- Regulator series R03:
  - **2-125 PSI** adjusting range
  - Balanced valve design
  - Self-relieving
  - Supplied with a GC620 gauge
  - Can be mounted with knob in up or down position
- Lubricator series L03:
  - 1 oz. bowl
  - Adjustable oil feed
  - Full view sight dome

**Specifications**

- Maximum operating conditions:
  - transparent bowl: 150 PSIG (10.3 bar) and 32°F to 125°F (0°C to 52°C)
  - metal bowl: 250 PSIG (17.2 bar) and 32°F to 175°F (0°C to 80°C)

Size	Flow (SCFM)	Transparent Bowl and Guard		Metal Bowl	
		Automatic Drain Part #	Manual Drain Part #	Automatic Drain Part #	Manual Drain Part #
1/8"	20	C03-01A	C03-01M	C03-01AMB	C03-01MMB
1/4"	20	C03-02A	C03-02M	C03-02AMB	C03-02MMB

SCFM ratings at 100 PSIG inlet pressure.

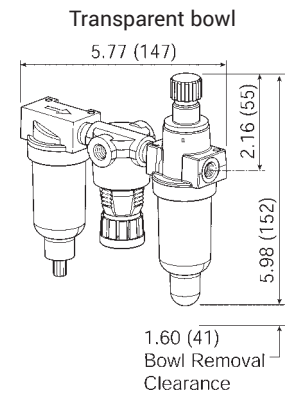

### C08-Series Miniature Combination Units

**Features**

- Included components: (2) mounting brackets with joiner set
- Filter series F08:
  - 5 micron element
  - .6 oz. bowl
- Regulator series R08:
  - **0-125 PSI** adjusting range
  - Balanced valve design
  - Self-relieving
  - Supplied with a **0-160 PSI** flush mount style gauge
- Lubricator series L08:
  - .6 oz. bowl
  - Adjustable oil feed
  - Full view sight dome

**Specifications**

- Maximum operating conditions:
  - transparent bowl: 150 PSIG (10.3 bar) and 14°F to 125°F (-10°C to 52°C)
  - metal bowl: 250 PSIG (17.2 bar) and 14°F to 150°F (-10°C to 65.5°C)

Size	Flow (SCFM)	Transparent Bowl and Guard		Metal Bowl	
		Automatic Drain Part #	Manual Drain Part #	Automatic Drain Part #	Manual Drain Part #
1/4"	27	C08-02A	C08-02M	C08-02AMB	C08-02MMB

NOTE: SCFM ratings at 100 PSIG inlet pressure.

FRLs are designed for air service only, unless otherwise indicated.

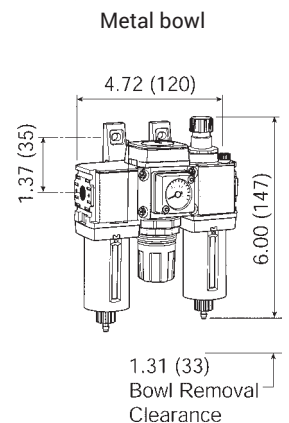

## Wilkerson FRLs

### F16-Series Compact Airline Filters

**Features**

- 5 micron element
- 2.7 oz. bowl

**Specifications**

- Maximum operating conditions:
  - transparent bowl: 150 PSIG (10.3 bar) and 32°F to 125°F (0°C to 52°C)
  - metal bowl: 200 PSIG (13.8 bar) and 32°F to 150°F (0°C to 65.5°C)



With guard

Size	Flow (SCFM)	Transparent Bowl and Guard		Metal Bowl	
		Automatic Drain Part #	Manual Drain Part #	Automatic Drain Part #	Manual Drain Part #
1/4"	63.0	F16-02A	F16-02M	F16-02AMB	F16-02MMB
3/8"	74.1	F16-03A	F16-03M	---	F16-03MMB
1/2"	80.4	F16-04A	F16-04M	F16-04AMB	F16-04MMB

### F18-Series Compact Airline Filters

**Features**

- High flow capacity
- 5 micron element
- 1.72 oz. bowl

**Specifications**

- Maximum operating conditions:
  - transparent bowl: 150 PSIG (10.3 bar) and -13°F to 125°F (-25°C to 52°C)
  - metal bowl: 250 PSIG (17.2 bar) and -13°F to 150°F (-25°C to 65.5°C)



Transparent bowl with guard

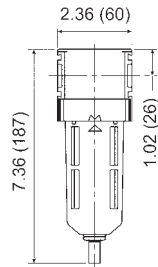

Size	Flow (SCFM)	Transparent Bowl and Guard		Metal Bowl with Sight Glass	
		Automatic Drain Part #	Manual Drain Part #	Automatic Drain Part #	Manual Drain Part #
1/4"	50	F18-02A	F18-02M	F18-02AMB	F18-02MMB
3/8"	78	F18-03A	F18-03M	F18-03AMB	F18-03MMB
1/2"	82	F18-04A	F18-04M	F18-04AMB	F18-04MMB

### F26-Series Standard Airline Filters

**Features**

- 5 micron element
- 3.2 oz. bowl

**Specifications**

- Maximum operating conditions:
  - transparent bowl: 150 PSIG (10.3 bar) and 32°F to 125°F (0°C to 52°C)
  - metal bowl: 200 PSIG (13.8 bar) and 32°F to 150°F (0°C to 65.5°C)



With guard

Size	Flow (SCFM)	Transparent Bowl and Guard		Metal Bowl with Sight Glass	
		Automatic Drain Part #	Manual Drain Part #	Automatic Drain Part #	Manual Drain Part #
3/8"	117.8	F26-03A	F26-03M	F26-03AMB	F26-03MMB
1/2"	149.8	F26-04A	F26-04M	F26-04AMB	F26-04MMB

NOTE: SCFM ratings at 150 PSIG inlet pressure. See pages 312 - 316 for accessories.

FRLs are designed for air service only, unless otherwise indicated.



### Wilkerson FRLs

#### F28-Series Standard Airline Filters

**Features**

- High flow capacity
- 5 micron element
- 2.87 oz. bowl

**Specifications**

- Maximum operating conditions:
  - transparent bowl: 150 PSIG (10.3 bar) and -13°F to 125°F (-25°C to 52°C)
  - metal bowl: 250 PSIG (17.2 bar) and -13°F to 150°F (-25.5°C to 65.5°C)

Size	Flow (SCFM)	Transparent Bowl and Guard		Metal Bowl with Sight Glass	
		Automatic Drain Part #	Manual Drain Part #	Automatic Drain Part #	Manual Drain Part #
3/8"	115	F28-03A	F28-03M	F28-03AMB	F28-03MMB
1/2"	120	F28-04A	F28-04M	F28-04AMB	F28-04MMB
3/4"	145	F28-06A	F28-06M	F28-06AMB	F28-06MMB



Transparent bowl with guard

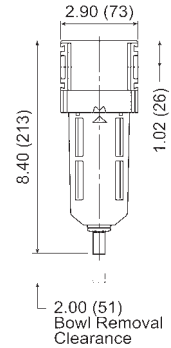

#### F30-Series Jumbo Airline Filters

**Features**

- 5 micron element
- 2 oz. bowl

**Specifications**

- Maximum operating conditions:
  - transparent bowl: 150 PSIG (10.3 bar) and 32°F to 125°F (0°C to 52°C)
  - metal bowl: 200 PSIG (13.8 bar) and 32°F to 150°F (0°C to 65.5°C)

Size	Flow (SCFM)	Transparent Bowl and Guard		Metal Bowl with Sight Glass	
		Automatic Drain Part #	Manual Drain Part #	Automatic Drain Part #	Manual Drain Part #
3/4"	316	F30-06A	F30-06M	F30-06AMB	F30-06MMB
1"	323	F30-08A	F30-08M	F30-08AMB	F30-08MMB



With guard

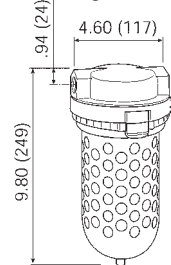

#### F35-Series Jumbo Airline Filters

**Features**

- 5 micron element
- 12.5 oz. bowl

**Specifications**

- Maximum operating conditions:
  - metal bowl: 150 PSIG (10.3 bar) and 32°F to 150°F (0°C to 65.5°C)

Size	Flow (SCFM)	Heavy Duty Metal Bowl	
		Automatic Drain Part #	Manual Drain Part #
1-1/2"	1280	F35-0BAMB	F35-0BMMB
2"	1400	F35-0CAMB	F35-0CMMB



With metal bowl

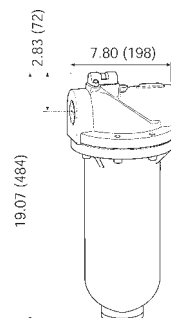

NOTE: SCFM ratings at 150 PSIG inlet pressure.

See pages 312 - 316 for accessories.

FRLs are designed for air service only, unless otherwise indicated.



## Wilkerson FRLs

### M16-Series Compact Coalescing Filters



With guard

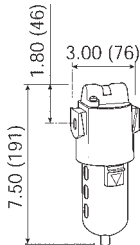

#### Features

- 0.01 micron type C element
- 2.7 oz. bowl
- Can be installed in modular system
- Removes extremely fine oil mists, oil aerosols, and microscopic particles
- A standard airline filter should be installed as a pre-filter when using a coalescing filter
- 0.5 micron type B and 0.003 micron type D elements are optional
- Differential pressure indicator changes from green to red with pressure loss



#### Specifications

- Maximum operating conditions: 150 PSIG (10.3 bar) and 32°F to 125°F (0°C to 52°C)

Size	Flow (SCFM)	With Compact Transparent Bowl and Guard	
		Automatic Drain Part #	Manual Drain Part #
1/4"	37.0	M16-02A	M16-02M
3/8"	44.7	M16-03A	M16-03M
1/2"	46.1	M16-04A	M16-04M

### M18-Series Compact Coalescing Filters



With guard

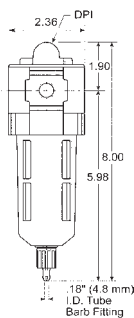

#### Features

- High-efficiency removal of water, oil aerosols, and solid particulate contaminants down to 0.01 mg/m<sup>3</sup> with minimum pressure drop
- Modern design and appearance
- Light weight
- High flow capacity
- 1.72 oz. bowl

#### Specifications

- Maximum operating conditions: 150 PSIG (10.3 bar) and -13°F to 125°F (-25°C to 52°C)

Size	Flow (SCFM)	With Compact Transparent Bowl and Guard	
		Automatic Drain Part #	Manual Drain Part #
1/4"	53	M18-02A	M18-02M
3/8"	36	M18-03A	M18-03M
1/2"	85	M18-04A	M18-04M

### M26-Series Standard Coalescing Filters



With guard

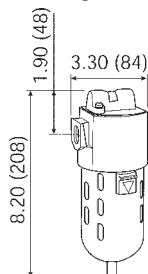

#### Features

- 0.01 micron type C element
- 1.7 oz. bowl
- Can be installed in modular system

#### Specifications

- Maximum operating conditions: 150 PSIG (10.3 bar) and 32°F to 125°F (0°C to 52°C)

Size	Flow (SCFM)	With Standard Transparent Bowl and Guard	
		Automatic Drain Part #	Manual Drain Part #
1/4"	55.0	---	---
3/8"	65.5	M26-03A	---
1/2"	79.5	M26-04A	M26-04M

NOTE: SCFM ratings at 150 PSIG inlet pressure.

See pages 312 - 316 for accessories.

FRLs are designed for air service only, unless otherwise indicated.





## Wilkerson FRLs

### M28-Series Standard Coalescing Filters

**Features**

- Removes extremely fine oil mists, oil aerosols, and microscopic particles
- A standard airline filter should be installed as a pre-filter when using a coalescing filter
- 0.5 micron type B and 0.003 micron type D elements are optional
- Differential pressure indicator changes from green to red with pressure loss
- High-efficiency removal of water, oil aerosols, and solid particulate contaminants down to 0.01 mg/m<sup>3</sup> with minimum pressure drop
- Modern design and appearance
- Light weight
- High flow capacity
- 2.87 oz. bowl



**Specifications**

- Maximum operating conditions: 150 PSIG (10.3 bar) and -13°F to 125°F (-25°C to 52°C)

Size	Flow (SCFM)	Compact Transparent Bowl and Guard	
		Automatic Drain Part #	Manual Drain Part #
3/8"	68	M28-03A	M28-03M
1/2"	42	M28-04A	M28-04M
3/4"	72	M28-06A	M28-06M

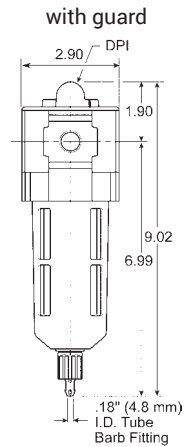

### M30-Series Jumbo Coalescing Filters

**Features**

- 0.01 micron type C element
- 2 oz. bowl

**Specifications**

- Maximum operating conditions: 150 PSIG (10.3 bar) and 32°F to 125°F (0°C to 52°C)

Size	Flow (SCFM)	Jumbo Transparent Bowl and Guard
		Automatic Drain Part #
1/2"	123	M30-04A
3/4"	173	M30-06A
1"	203	M30-08A

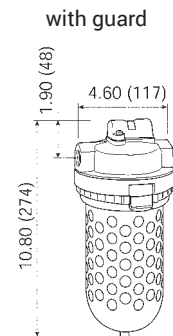

NOTE: SCFM ratings at 150 PSIG inlet pressure.

See pages 312 - 316 for accessories.

FRLs are designed for air service only, unless otherwise indicated.

## Wilkerson FRLs

### M35-Series Heavy Duty Coalescing Filters

#### Features

- For removal of extremely fine oil mists, oil aerosols, and microscopic particles
- A standard airline filter should be installed as a pre-filter when using a coalescing filter
- 1.0 micron type B1 and 0.003 micron type D elements are optional
- Differential pressure indicator changes from green to red with pressure loss
- 0.01 micron type C element
- 13.9 oz. bowl
- Differential pressure indicator eliminates the guesswork of element placement



#### Specification

- Maximum operating conditions: 150 PSIG (10.3 bar) and 32°F to 150°F (0°C to 65.5°C)



M35-0CAMB

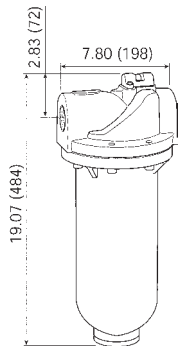

Size	Flow (SCFM)	Metal Bowl Automatic Drain Part #
1-1/2"	710	M35-0BAMB
2"	710	M35-0CAMB

NOTE: SCFM ratings at 150 PSIG inlet pressure.

See pages 312 - 316 for accessories.

FRLs are designed for air service only, unless otherwise indicated.



## Wilkerson FRLs

### X03-Series Manual In-Line Desiccant Dryers

#### Applications

- Manual air dryers are used to remove water vapor from compressed air systems, in applications such as paint spraying, laboratory instruments and small control air systems. Filtration for absorber type dryers is important to protect the desiccant bed from contamination. Cleaner incoming air will result in better performance, longer life, and fewer service problems. To regenerate silica gel desiccant, it must be heated to at least **350°F (177°C)** for approximately 3 hours or until color has changed from pink to blue. Allow desiccant to cool to room temperature before pouring back into unit bowl.
- An after-filter should be placed downstream from the desiccant dryer to ensure solid contaminants such as desiccant dust do not migrate downstream



#### Features

- Will dry up to 4,400 standard cubic feet of air
- Desiccant; good for approximately 440 minutes at maximum continuous air flow before regeneration is required
- Supplied with two bags of silica gel, which changes from blue to pink to indicate the need to replace or regenerate the desiccant. See page 312 for refills.
- Slotted bowl guard for visual detection of color change
- No electrical connection necessary

#### Specifications

- Provides atmospheric dew point of **-45°F (-43°C)** with dry desiccant at **100 PSI** and **70°F (21°C)**
- Maximum operating conditions:
  - transparent bowl: 150 PSIG (10.3 bar) and **125°F (52°C)**
  - metal bowl: 150 PSIG (10.3 bar) and **150°F (66°C)**

Size	Flow (SCFM)	Transparent Bowl Part #	Metal Bowl Part #
1/4"	10	X03-02	X03-02MB



with transparent bowl

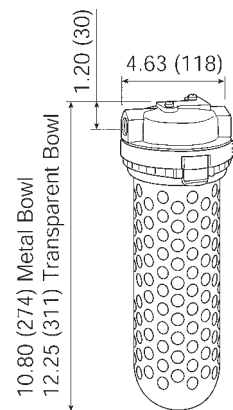

### R21-Series Dial Air Regulators

#### Applications

- Dial-air regulators feature a transparent, pressure-calibrated, non-rising adjustment dial for quick adjustment of secondary pressure. The full reduced pressure range can be dialed in less than 270° of dial rotation. This feature is particularly advantageous if secondary pressure must be changed frequently. Dial air regulators can be mounted in any position so dial face is always visible. All dial-air units have a slight constant air bleed.

#### Features

- 0-160 PSI** adjusting range
- Balanced valve design
- Relieving type
- Non-rising pressure adjusting dial
- Piston operated
- Two -1/4" NPT gauge ports standard on models without gauge, one 1/4" NPT gauge port standard on models with gauge - can be used for additional outlet ports.
- Models supplied without gauge use a GC235 gauge

#### Specifications

- Maximum operating pressure: 300 PSIG (20.7 bar)
- Temperature range: **32°F to 150°F (0°C to 66°C)**

Size	Flow (SCFM)	With Gauge Part #	Without Gauge Part #
1/4"	117	R21-02RG	R21-02R
3/8"	180	R21-03RG	R21-03R
1/2"	195	R21-04RG	R21-04R
3/4"	220	R21-06RG	R21-06R

NOTE: SCFM ratings at 100 PSIG inlet pressure.

See pages 312 - 316 for accessories.

FRLs are designed for air service only, unless otherwise indicated.

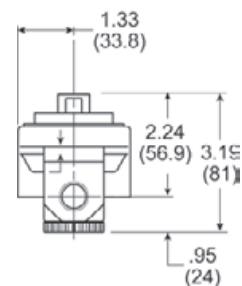

## Wilkerson FRLs

### R16-Series Compact Regulators

#### Features

- 0-125 PSI adjusting range
- For 0-60 PSI range consult Dixon®
- Self-relieving standard
- Can be installed with the adjusting knob in any position
- To increase regulated pressure, pull adjusting knob up and turn clockwise, to reduce pressure, turn knob counter clockwise
- Two 1/4" NPT gauge ports standard on models without gauge, one 1/4" NPT gauge port standard on models with gauge - can be used for additional outlet ports
- Models supplied without gauge use a GC230 gauge

#### Specifications

- Maximum operating conditions: 300 PSIG (20.7 bar) and 32°F to 150°F (0°C to 66°C)

Size	Flow (SCFM)	With Gauge Part #	Without Gauge Part #
1/4"	71.5	R16-02RG	R16-02R
3/8"	80.5	R16-03RG	R16-03R
1/2"	88.0	R16-04RG	R16-04R

### R16-Series High Pressure Compact Regulators

#### Features

- 0-250 PSI adjusting range
- Self-relieving standard
- Non-rising push/pull locking adjustment knob
- Panel mount nut standard
- Excellent flow characteristics
- Can be installed with the adjusting knob in any position
- Two 1/4" NPT gauge ports standard on models without gauge, one 1/4" NPT gauge port standard on models with gauge - can be used for additional outlet ports
- Models supplied without gauge use a GC240 gauge

#### Specifications

- Maximum operating conditions: 300 PSIG (20.7 bar) and 32°F to 150°F (0°C to 66°C)

Size	Flow (SCFM)	With Gauge Part #	Without Gauge Part #
1/4"	71.5	R16-02RHG	R16-02RH
3/8"	80.5	R16-03RHG	R16-03RH
1/2"	88.0	R16-04RHG	R16-04RH

### R18-Series Compact Regulators

#### Features

- 0-125 PSI adjusting range
- Self-relieving standard
- Can be installed with the adjusting knob in any position
- To increase regulated pressure, pull adjusting knob up and turn clockwise, to reduce pressure, turn knob counter clockwise.
- Two 1/4" NPT gauge ports located on the front and rear faces of the body; ports may be used as additional regulated ports or for pressure gauges
- Models supplied without gauge use a GC230 gauge

#### Specifications

- Maximum operating conditions: 300 PSIG (20.7 bar) and -13°F to 125°F (-25°C to 52°C)

Size	Flow (SCFM)	With Gauge Part #	Without Gauge Part #
1/4"	142	R18-02RG	R18-02R
3/8"	165	R18-03RG	R18-03R
1/2"	165	R18-04RG	R18-04R

NOTE: SCFM ratings at 100 PSIG inlet pressure.  
See pages 312 - 316 for accessories.

FRLs are designed for air service only, unless otherwise indicated.

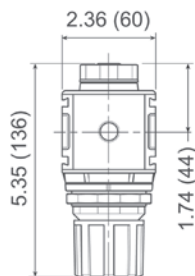
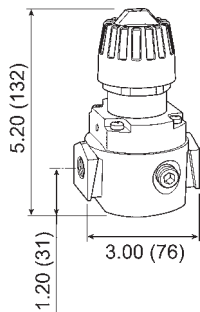
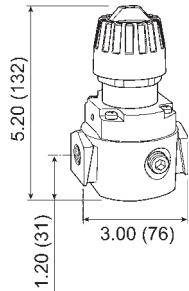

## Wilkerson FRLs

### R26-Series Standard Regulators

#### Features

- **0-125 PSI** adjusting range
- Non-rising push/pull locking adjustment knob
- Panel mount nut standard
- Excellent flow characteristics
- Can be installed with the adjusting knob in any position
- To increase regulated pressure, pull adjusting knob up and turn clockwise, to reduce pressure, turn knob counter clockwise
- Two 1/4" NPT gauge ports standard on models without gauge, one 1/4" NPT gauge port standard on models with gauge - can be used for additional outlet ports
- Models supplied without gauge use a GC230 gauge

#### Specifications

- Maximum operating conditions: 300 PSIG (20.7 bar) and 32°F to 150°F (0°C to 66°C)

Size	Flow (SCFM)	With Gauge Part #	Without Gauge Part #
3/8"	148	R26-03RG	R26-03R
1/2"	185	R26-04RG	R26-04R

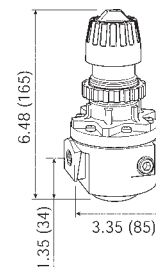

F

### R26-Series High Pressure Standard Regulators

#### Features

- **0-250 PSI** adjusting range
- Self-relieving standard
- Non-rising push/pull locking adjustment knob
- Panel mount nut standard
- Excellent flow characteristics
- Can be installed with the adjusting knob in any position
- Two 1/4" NPT gauge ports standard on models without gauge, one 1/4" NPT gauge port standard on models with gauge can be used for additional outlet ports
- Models supplied without gauge use a GC240 gauge

#### Specifications

- Maximum operating conditions: 300 PSIG (20.7 bar) and 32°F to 150°F (0°C to 66°C)

Size	Flow (SCFM)	With Gauge Part #	Without Gauge Part #
3/8"	148	R26-03RHG	R26-03RH
1/2"	185	R26-04RHG	R26-04RH

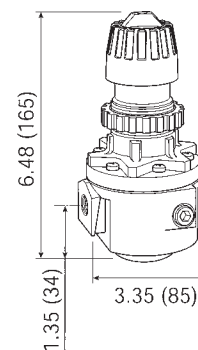

NOTE: SCFM ratings at 100 PSIG inlet pressure.

See pages 312 - 316 for accessories.

FRLs are designed for air service only, unless otherwise indicated.

## Wilkerson FRLs

### R28-Series Standard Regulators



#### Features

- 0-125 PSI adjusting range
- Self-relieving standard
- Four adjusting pressure ranges available
- To increase regulated pressure, pull adjusting knob up and turn clockwise, to reduce pressure, turn knob counter clockwise.
- Two 1/4" NPT gauge ports located on the front and rear faces of the body; ports may be used as additional regulated ports or for pressure gauges.
- Models supplied without gauge use a GC230 gauge

#### Specifications

- Maximum operating conditions: 300 PSIG (20.7 bar) and -13°F to 125°F (-25°C to 52°C)

Size	Flow (SCFM)	With Gauge Part #	Without Gauge Part #
3/8"	228	R28-03RG	R28-03R
1/2"	233	R28-04RG	R28-04R
3/4"	233	R28-06RG	R28-06R

### R30-Series High Flow Regulators

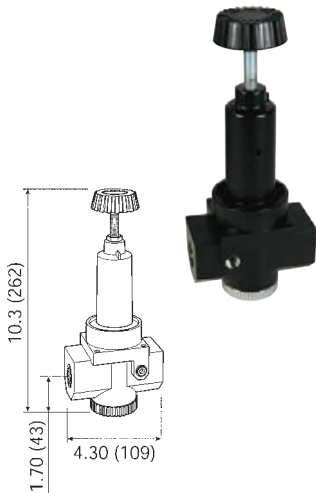

#### Features

- 0-125 PSI adjusting range
- Self-relieving standard
- Piston operated
- Can be installed with the adjusting knob in any position
- To increase regulated pressure, pull adjusting knob up and turn clockwise, to reduce pressure, turn knob counter clockwise.
- Two 1/4" NPT gauge ports standard on models without gauge, one 1/4" NPT gauge port standard on models with gauge - can be used for additional outlet ports
- Models supplied without gauge use a GC230 gauge

#### Specifications

- Maximum operating conditions: 300 PSIG (20.7 bar) and 32°F to 150°F (0°C to 66°C)

Size	Flow (SCFM)	With Gauge Part #	Without Gauge Part #
3/4"	481	R30-06RG	R30-06R
1"	500	R30-08RG	R30-08R

### R30-Series High Pressure High Flow Regulators

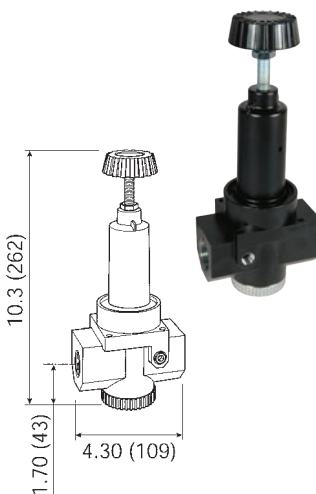

#### Features

- 0-180 PSI adjusting range
- Self-relieving standard
- Piston operated
- Can be installed with the adjusting knob in any position
- To increase regulated pressure, pull adjusting knob up and turn clockwise, to reduce pressure, turn knob counter clockwise
- Two 1/4" NPT gauge ports standard on models without gauge, one 1/4" NPT gauge port standard on models with gauge - can be used for additional outlet ports
- Models supplied without gauge use a GC240 gauge

#### Specifications

- Maximum operating conditions: 300 PSIG (20.7 bar) and 32°F to 150°F (0°C to 66°C)

Size	Flow (SCFM)	With Gauge Part #	Without Gauge Part #
3/4"	481	R30-06RHG	R30-06RH
1"	500	R30-08RHG	R30-08RH

NOTE: SCFM ratings at 100 PSIG inlet pressure.

See pages 312 - 316 for accessories.

FRLs are designed for air service only, unless otherwise indicated.



## Wilkerson FRLs

### R40-Series High Flow Regulators

#### Features

- 0-125 PSI adjusting range
- Self-relieving standard
- Piston operated
- Can be installed with the adjusting knob in any position
- To increase regulated pressure, pull adjusting knob up and turn clockwise, to reduce pressure, turn knob counter clockwise
- Two 1/4" NPT gauge ports standard on models without gauge; one 1/4" NPT gauge port standard on models with gauge - can be used for additional outlet ports
- Models supplied without gauge use a GC230 gauge

#### Specifications

- Maximum operating conditions:  
300 PSIG (20.7 bar) and 32°F to 150°F (0°C to 66°C)

Size	Flow (SCFM)	With Gauge Part #	Without Gauge Part #
1-1/2"	1200	R40-0BRG	R40-0BR
2"	1200	R40-0CRG	R40-0CR

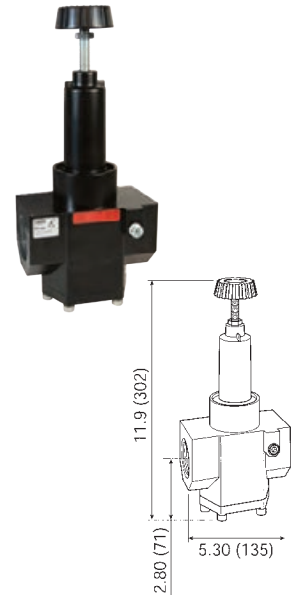

F

### R40-Series High Pressure High Flow Regulators

#### Features

- 0-180 PSI adjusting range
- Self-relieving standard
- Piston operated
- Can be installed with the adjusting knob in any position
- To increase regulated pressure, pull adjusting knob up and turn clockwise, to reduce pressure, turn knob counter clockwise
- Two 1/4" NPT gauge ports standard on models without gauge; one 1/4" NPT gauge port standard on models with gauge - can be used for additional outlet ports
- Models supplied without gauge use a GC240 gauge

#### Specifications

- Maximum operating conditions:  
300 PSIG (20.7 bar) and 32°F to 150°F (0°C to 66°C)

Size	Flow (SCFM)	With Gauge Part #	Without Gauge Part #
1-1/2"	1200	R40-0BRHG	R40-0BRH
2"	1200	R40-0CRHG	R40-0CRH

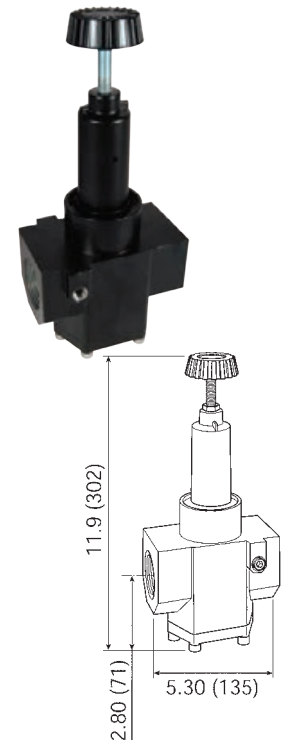

NOTE: SCFM ratings at 100 PSIG inlet pressure.

See pages 312 - 316 for accessories.

FRLs are designed for air service only, unless otherwise indicated.



## Wilkerson FRLs

### CB6-Series Compact Filter / Regulators

Over-under units are space savers and provide for installation in tight areas. One common inlet/outlet for both filter and regulator saves on piping costs.

#### Features

- 0-125 PSIG adjusting range
- 5 micron reusable element
- Self-relieving standard
- Diaphragm operated
- Quick-disconnect bowl guard with integral plastic bowl and safety latch standard
- Two 1/4" gauge ports are provided in either side of the regulator body for installation of a gauge or to use as an additional outlet port, plug unused port(s)
- Supplied with GC230 gauge

#### Specifications

- Maximum operating conditions:
  - transparent bowl: 150 PSIG (10.3 bar) and 32°F to 125°F (0°C to 52°C)
  - metal bowl: 200 PSIG (13.8 bar) and 32°F to 150°F (0°C to 66°C)



with guard

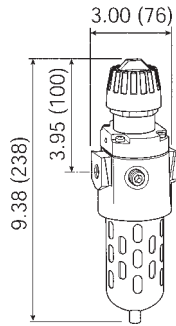

with metal bowl

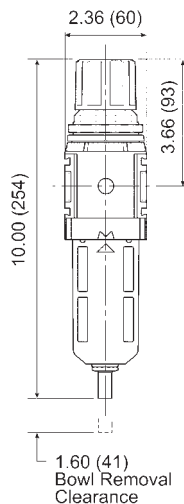

### B18-Series Compact Filter / Regulators

#### Features

- 5-125 PSIG adjusting range for transparent bowl with guard
- 10-250 PSIG adjusting range for metal bowl with sight glass
- 5 micron element
- 1.72 oz. bowl
- Self-relieving standard
- Spring-loaded diaphragm
- To increase regulated pressure, pull adjusting knob and turn clockwise, to reduce pressure, turn knob counter clockwise, to lock knob, push down
- Two 1/4" gauge ports located on the front and rear faces of the body, these ports may be used as additional regulated ports or for pressure gauges, plug unused port(s)
- Transparent bowl supplied with GC230 gauge
- Metal bowl supplied with GC240 gauge

#### Specifications

- Maximum operating conditions:
  - transparent bowl: 150 PSIG (10.3 bar) and -13°F to 125°F (-25°C to 52°C)
  - metal bowl: 250 PSIG (17.2 bar) and -13°F to 150°F (-25°C to 66°C)

Size	Flow (SCFM)	Transparent Bowl and Guard		Metal Bowl with Sight Glass	
		Automatic Drain Part #	Manual Drain Part #	Automatic Drain Part #	Manual Drain Part #
1/4"	148	B18-02AG	B18-02MG	B18-02AGMB	B18-02MGMB
3/8"	158	B18-03AG	B18-03MG	B18-03AGMB	B18-03MGMB
1/2"	164	B18-04AG	B18-04MG	B18-04AGMB	B18-04MGMB

NOTE: SCFM ratings at 100 PSIG inlet pressure.

See pages 312 - 316 for accessories.

FRLs are designed for air service only, unless otherwise indicated.





## Wilkerson FRLs

### B28-Series Standard Filters/Regulators

#### Features

- 5-125 PSIG adjusting range for transparent bowl with guard
- 10-250 PSIG adjusting range for metal bowl with sight glass
- 5 micron element
- 2.87 oz. bowl
- Self-relieving standard
- Spring-loaded diaphragm
- To increase regulated pressure, pull adjusting knob and turn clockwise, to reduce pressure, turn knob counter clockwise, to lock knob, push down
- Two 1/4" gauge ports located on the front and rear faces of the body. These ports may be used as additional regulated ports or for pressure gauges. Plug unused port(s).
- Transparent bowl supplied with GC230 gauge
- Metal bowl supplied with GC240 gauge

#### Specifications

- Maximum operating conditions:
  - transparent bowl: 150 PSIG (10.3 bar) and -13°F to 125°F (-25°C to 52°C)
  - metal bowl: 250 PSIG (17.2 bar) and -13°F to 150°F (-25°C to 66°C)

Size	Flow (SCFM)	Transparent Bowl and Guard		Metal Bowl with Sight Glass	
		Automatic Drain Part #	Manual Drain Part #	Automatic Drain Part #	Manual Drain Part #
3/8"	200	B28-03AG	B28-03MG	B28-03AGMB	B28-03MGMB
1/2"	200	B28-04AG	B28-04MG	B28-04AGMB	B28-04MGMB
3/4"	235	B28-06AG	B28-06MG	B28-06AGMB	B28-06MGMB

NOTE: See pages 312 - 316 for accessories.  
SCFM ratings at 100 PSIG inlet pressure.



with transparent bowl

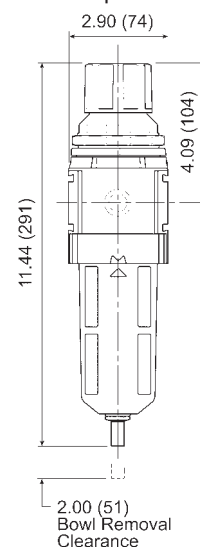

### L16-Series EconOmist® Compact Lubricators

Designed so that all the oil flow observed in the sight dome is broken into a mist and delivered via the airflow to the application. The oil in the bowl can be filled or replenished without interrupting airflow or bleeding pressure from the system. Once the oil-fill cap is removed, the bowl is depressurized and isolated from line pressure, and the bowl itself can then be removed for faster refill, if desired. The bowl can be filled right to the top.

#### Features

- 5 oz. bowl
- Full view sight dome
- Fill under pressure design

#### Specifications

- Maximum operating conditions:
  - transparent bowl: 150 PSIG (10.3 bar) and 32°F to 125°F (0°C to 52°C)
  - metal bowl: 200 PSIG (13.8 bar) and 32°F to 150°F (0°C to 66°C)

Size	Flow (SCFM)	Transparent Bowl Part #	Metal Bowl Part #
1/4"	36.1	L16-02A	L16-02AMB
3/8"	58.5	L16-03A	L16-03AMB
1/2"	64.0	L16-04A	L16-04AMB

NOTE: SCFM ratings at 150 PSIG inlet pressure.

See pages 312 - 316 for accessories.

See page 267 for air tool lubricant.

FRLs are designed for air service only, unless otherwise indicated.



transparent bowl with guard

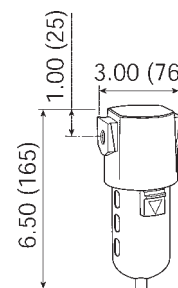

## Wilkerson FRLs

### Flow Guide®

The elastomer disc-shaped device is located in the throat of all Wilkerson lubricators and automatically maintains a constant ratio of oil flow to airflow regardless of changing rates of airflow. This allows one lubricator to serve several pneumatic components operating together or intermittently.

### Type of oil to use

For all Wilkerson lubricators, use any petroleum-base, non-detergent light weight oil (SAE 10/150SSU) which will readily break up into a mist, i.e., Mobil DTE light or comparable oil. Do not use synthetic oil or any oils containing additives or solvents. See page 267 for air tool lubricants.

### L18-Series EconOmist® Compact Lubricators

#### Features

- 4 oz. bowl
- Manual drain
- High flow capacity
- Can be filled under pressure
- To adjust and set oil delivery rate the unit must be pressurized and air must be flowing through the unit. Turn the sight dome, located on the top of the unit, counter clockwise to initiate oil delivery. The rate of oil delivery depends on air flow rate. If flow increases or decreases, the oil delivery rate will increase or decrease proportionally. Turning the sight dome clockwise will stop all oil delivery

#### Specifications

- Maximum operating conditions:
  - transparent bowl: 150 PSIG (10.3 bar) and 14°F to 125°F (-10°C to 52°C)
  - metal bowl: 250 PSIG (17.2 bar) and 14°F to 150°F (-10°C to 65.5°C)

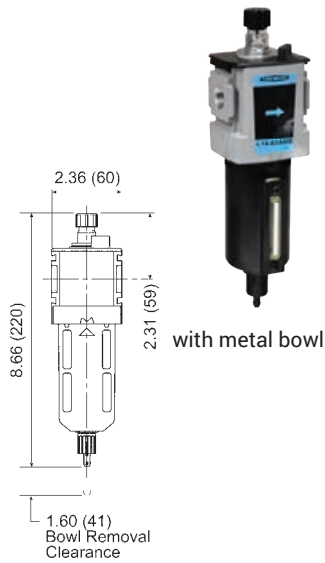

Size	Flow (SCFM)	Transparent Bowl Part #	Metal Bowl Part #
1/4"	88	L18-02A	L18-02AMB
3/8"	90	L18-03A	L18-03AMB
1/2"	96	L18-04A	L18-04AMB

### L26-Series EconOmist® Standard Lubricators

#### Features

- 10 oz. bowl
- Adjustable oil feed
- Can be filled under pressure
- Quick-disconnect metal bowl guard with integral safety latch
- Siphon tube filter provides clean lubricant downstream
- The rate of oil delivery may be controlled by turning the adjusting screw counter clockwise for more and clockwise for less oil delivery. If flow increases or decreases, the oil delivery rate will increase or decrease proportionally

#### Specifications

- Maximum operating conditions:
  - transparent bowl: 150 PSIG (10.3 bar) and 32°F to 125°F (0°C to 52°C)
  - metal bowl: 200 PSIG (13.8 bar) and 32°F to 150°F (0°C to 66°C)

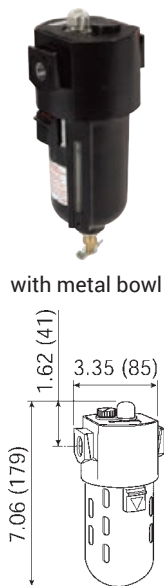

Size	Flow (SCFM)	Transparent Bowl Part #	Metal Bowl <sup>1</sup> Part #
3/8"	60	L26-03A	L26-03AMB
1/2"	128	L26-04A	L26-04AMB

<sup>1</sup> Metal bowl has sight gauge with brass petcock drain

NOTE: SCFM ratings at 150 PSIG inlet pressure.

See pages 312 - 316 for accessories.

See page 267 for air tool lubricant.

FRLs are designed for air service only, unless otherwise indicated.

F

### Wilkerson FRLs

#### L28 EconOmist® Standard Lubricators

**Features**

- 6 oz. bowl
- Manual drain
- High flow capacity
- Can be filled under pressure
- To adjust and set oil delivery rate the unit must be pressurized and air must be flowing through the unit. Turn the sight dome, located on the top of the unit, counter clockwise to initiate oil delivery. If flow increases or decreases, the oil delivery rate will increase or decrease proportionally. Turning the sight dome clockwise will stop all oil delivery

**Specifications**

- Maximum operating conditions:
  - transparent bowl: 150 PSIG (10.3 bar) and 14°F to 125°F (-10°C to 52°C)
  - metal bowl: 250 PSIG (17.2 bar) and 14°F to 150°F (-10°C to 65.5°C)

Size	Flow (SCFM)	Transparent Bowl Part #	Metal Bowl Part #
3/8"	110	L28-03A	L28-03AMB
1/2"	110	L28-04A	L28-04AMB
3/4"	150	L28-06A	L28-06AMB

NOTE: SCFM ratings at 150 PSIG inlet pressure.



with metal bowl

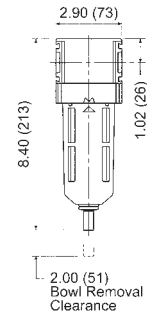

#### L30 EconOmist® Standard Lubricators

**Features**

- 26 oz. bowl
- Transparent bowl: no drain
- metal bowl: manual brass petcock drain
- Can be filled under pressure
- The rate of oil delivery may be controlled by turning the adjusting screw counter clockwise for more and clockwise for less oil delivery. The oil delivery rate will change automatically to deliver more oil during higher air flows and less oil for air flows lower than the one at which the setting was made

**Specifications**

- Maximum operating conditions:
  - transparent bowl: 150 PSIG (10.3 bar) and 32°F to 125°F (0°C to 52°C)
  - metal bowl: 200 PSIG (13.8 bar) and 32°F to 150°F (0°C to 66°C)

Size	Flow (SCFM)	Transparent Bowl Part #	Metal Bowl Part #
3/4"	196	L30-06A	L30-06AMB
1"	374	L30-08A	L30-08AMB

NOTE: SCFM ratings at 120 PSIG inlet pressure.



with metal bowl

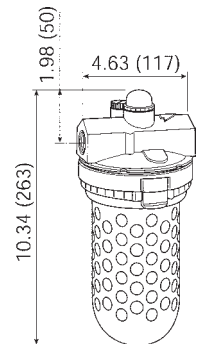

NOTE: SCFM ratings at 150 PSIG inlet pressure.

See pages 312 - 316 for accessories.

See page 267 for air tool lubricant.

FRLs are designed for air service only, unless otherwise indicated. 

### Wilkerson FRLs

#### L40 & L50-Series EconOmist® Standard Lubricators

**Features**

- 26 oz. bowl
- Transparent bowl: solid bottom  
metal bowl: manual drain with sight glass
- Full view sight dome
- Adjustable oil feed
- Can be filled under pressure
- Quick-disconnect clamp ring for easy bowl removal
- The rate of oil delivery may be controlled by turning the adjusting screw counter clockwise for more and clockwise for less oil delivery. The oil delivery rate will change automatically to deliver more oil during higher air flows and less oil for air flows lower than the one at which the setting was made

**Specifications**

- Maximum operating conditions:
  - transparent bowl: 150 PSIG (10.3 bar) and 32°F to 125°F (0°C to 52°C)
  - metal bowl: 200 PSIG (13.8 bar) and 32°F to 150°F (0°C to 66°C)



transparent bowl with guard

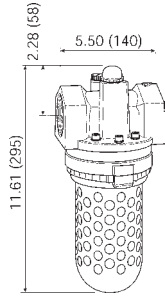

illustration represents L40 series

F

Size	Flow (SCFM)	Transparent Bowl Part #	Metal Bowl with Sight Glass Part #
1-1/2"	927	L40-0BA	L40-0BAMB
2"	1186	L50-0CA	L50-0CAMB

NOTE: See pages 312 - 316 for accessories.

See page 267 for air tool lubricant.

FRLs are designed for air service only, unless otherwise indicated.

SCFM ratings at 120 PSIG inlet pressure.

#### C16-Series Compact Combination Units

**Features**

- Included components:
  - (2) modular sleeves
  - (2) mounting brackets (sleeve and bracket)
  - (2) end blocks

Filter series F16:

- 5 micron element
- 2.7 oz. bowl

Regulator series R16:

- 0-125 PSI adjusting range
- Self-relieving
- Supplied with a GC230 gauge

Lubricator series L16:

- 5 oz. bowl
- Adjustable oil feed
- Full view sight dome



transparent bowl with guard

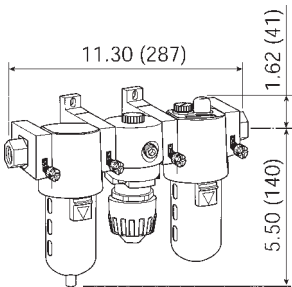

**Specifications**

- Maximum operating conditions:
  - transparent bowl: 150 PSIG (10.3 bar) and 32°F to 125°F (0°C to 52°C)
  - metal bowl: 200 PSIG (13.8 bar) and 32°F to 175°F (0°C to 80°C)

Size	Flow (SCFM)	Transparent Bowl and Guard		Metal Bowl with Sight Glass	
		Automatic Drain Part #	Manual Drain Part #	Automatic Drain Part #	Manual Drain Part #
1/4"	36.1	C16-02A	C16-02M	C16-02AMB	C16-02MMB
3/8"	58.5	C16-03A	C16-03M	---	C16-03MMB
1/2"	64.0	C16-04A	C16-04M	C16-04AMB	C16-04MMB

NOTE: SCFM ratings at 150 PSIG inlet pressure.

FRLs are designed for air service only, unless otherwise indicated.

## Wilkerson FRLs

### C18-Series Compact Combination Units

#### Features

- Included components:
  - (2) end blocks
  - (2) mounting brackets with joiner set and port O-ring

#### Filter series F18:

- 5 micron element
- 1.72 oz. bowl

#### Regulator series R18:

- **0-125 PSI** adjusting range
- Self-relieving
- Supplied with a GC230 gauge

#### Lubricator series L18:

- 4 oz. bowl
- Adjustable oil feed
- Full view sight dome

#### Specifications

- Maximum operating conditions:
  - transparent bowl: 150 PSIG (10.3 bar) and **-13°F to 125°F (-25°C to 52°C)**
  - metal bowl: 250 PSIG (17.2 bar) and **-13°F to 150°F (-25°C to 66°C)**

Size	Flow (SCFM)	Transparent Bowl and Guard		Metal Bowl with Sight Glass	
		Automatic Drain Part #	Manual Drain Part #	Automatic Drain Part #	Manual Drain Part #
1/4"	42	C18-02A	C18-02M	C18-02AMB	C18-02MMB
3/8"	68	C18-03A	C18-03M	C18-03AMB	C18-03MMB
1/2"	85	C18-04A	C18-04M	C18-04AMB	C18-04MMB



with metal bowl

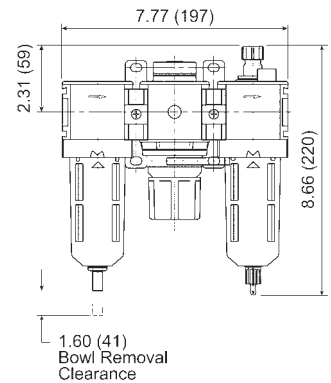

### C26-Series Standard Combination Units

#### Features

- Included components:
  - (2) modular sleeves
  - (2) mounting brackets (sleeve and bracket)
  - (2) end blocks

#### Filter series F26:

- 5 micron element
- 3.2 oz. bowl

#### Regulator series R26:

- **0-125 PSI** adjusting range
- Self-relieving
- Supplied with a GC230 gauge

#### Lubricator series L26:

- 10 oz. bowl
- Adjustable oil feed
- Full view sight dome

#### Specifications

- Maximum operating conditions:
  - transparent bowl: 150 PSIG (10.3 bar) and **32°F to 125°F (0°C to 52°C)**
  - metal bowl: 200 PSIG (13.8 bar) and **32°F to 175°F (0°C to 80°C)**

Size	Flow (SCFM)	Transparent Bowl and Guard		Metal Bowl	
		Automatic Drain Part #	Manual Drain Part #	Automatic Drain Part #	Manual Drain Part #
3/8"	60	C26-03A	C26-03M	C26-03AMB	C26-03MMB
1/2"	128	C26-04A	C26-04M	C26-04AMB	C26-04MMB



with metal bowl

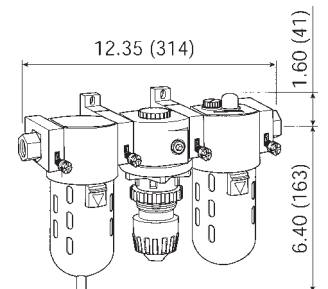

NOTE: SCFM ratings at 150 PSIG inlet pressure.

FRLs are designed for air service only, unless otherwise indicated.

## Wilkerson FRLs

### C28-Series Standard Combination Units

#### Features

- Modern design and appearance
- Quick disconnect bowl / bowl guard
- Included components:
  - (2) end blocks
  - (2) mounting brackets with joiner set and port O-ring

#### Filter series F28:

- 5 micron element
- 2.87 oz. bowl

#### Regulator series R28:

- **0-125 PSI** adjusting range
- Self-relieving
- Supplied with a GC230 gauge

#### Lubricator series L28:

- 6 oz. bowl
- Adjustable oil feed
- Full view sight dome



with metal bowl

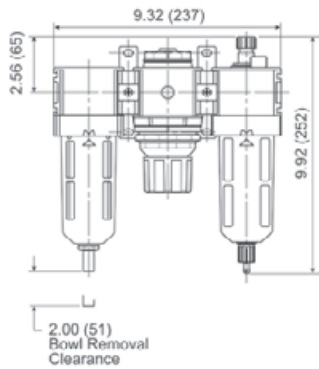

#### Specifications

- Maximum operating conditions:
  - transparent bowl: 150 PSIG (10.3 bar) and -13°F to 125°F (-25°C to 52°C)
  - metal bowl: 250 PSIG (17.2 bar) and -13°F to 150°F (-25°C to 66°C)

Size	Flow (SCFM)	Transparent Bowl and Guard		Metal Bowl	
		Automatic Drain Part #	Manual Drain Part #	Automatic Drain Part #	Manual Drain Part #
3/8"	90	C28-03A	C28-03M	C28-03AMB	C28-03MMB
1/2"	90	C28-04A	C28-04M	C28-04AMB	C28-04MMB
3/4"	110	C28-06A	C28-06M	C28-06AMB	C28-06MMB

NOTE: SCFM ratings given at 150 PSIG inlet pressure.

### C31-Series Jumbo Combination Units

#### Features

- High flow capacity
- Large bowl reservoir
- Included components:
  - (2) brass hex nipples

#### Filter series F30:

- 5 micron element
- 2 oz. bowl

#### Regulator series R30:

- **0-125 PSI** adjusting range
- Self-relieving
- Supplied with a GC230 gauge

#### Lubricator series L30:

- 26 oz. bowl
- Adjustable oil feed
- Full view sight dome



with metal bowl

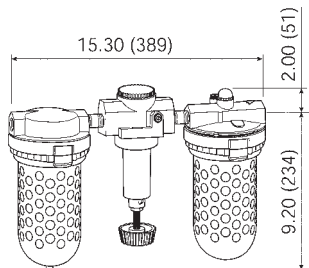

#### Specifications

- Maximum operating conditions:
  - transparent bowl: 150 PSIG (10.3 bar) and 32°F to 125°F (0°C to 52°C)
  - metal bowl: 200 PSIG (13.8 bar) and 32°F to 175°F (0°C to 80°C)

Size	Flow (SCFM)	Transparent Bowl and Guard		Metal Bowl with Sight Glass	
		Automatic Drain Part #	Manual Drain Part #	Automatic Drain Part #	Manual Drain Part #
3/4"	374	C31-06A	C31-06M	C31-06AMB	C31-06MMB
1"	374	C31-08A	C31-08M	C31-08AMB	C31-08MMB

NOTE: SCFM ratings at 120 PSIG inlet pressure.

FRLs are designed for air service only, unless otherwise indicated.

## Wilkerson FRLs

### D18-Series Combination Units

#### Features

- Light weight, ready-to-mount assembly comes standard with pressure gauge and modular T-bracket/joiner assembly
  - Components integrated into single unit
  - Modern design and appearance
  - Quick disconnect bowl / bowl guard
  - 5 micron element
  - 4 oz. bowl/lubricator
- Regulator
- **0-125 PSI** adjusting range
  - Self-relieving
  - Supplied with gauge
  - 1.72 oz. bowl/filter

#### Specifications

- Maximum operating conditions:
  - transparent bowl: 150 PSIG (10.3 bar) and **13°F to 125°F (-25°C to 52°C)**
  - metal bowl: 250 PSIG (17.2 bar) and **-13°F to 150°F (-25°C to 66°C)**



with transparent bowl and guard

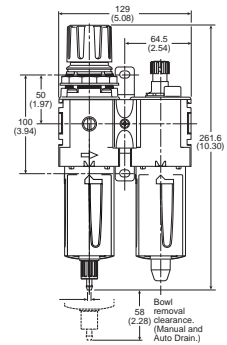

Size	Flow (SCFM)	Transparent Bowl and Guard	Metal Bowl / Sight Gauge
		Manual Drain Part #	Manual Drain Part #
1/2"	90	D18-04M	D18-04MMB

NOTE: SCFM ratings at 150 PSIG inlet pressure.

### D28-Series Combination Units

#### Features

- Light weight, ready-to-mount assembly comes standard with pressure gauge and modular T-bracket/joiner assembly
  - Components integrated into single unit
  - Modern design and appearance
  - Quick disconnect bowl / bowl guard
  - 5 micron element
  - 6 oz. bowl/lubricator
- Regulator
- **0-125 PSI** adjusting range
  - Self-relieving
  - Supplied with gauge
  - 2.87 oz. bowl/filter

#### Specifications

- Maximum operating conditions:
  - 250 PSIG (17.2 bar) and **-13°F to 125°F (-25°C to 52°C)**



with metal bowl

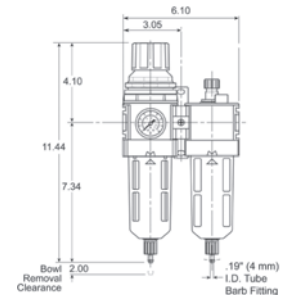

Size	Flow (SCFM)	Metal Bowl / Sight Gauge
		Manual Drain Part #
1/2"	150	D28-04MMB
3/4"	150	D28-06MMB

NOTE: SCFM ratings at 150 PSIG inlet pressure.

FRLs are designed for air service only, unless otherwise indicated.

## Wilkerson FRLs

### C31-Series Combination Unit with Protective Frame

#### Application

- Provides downstream air preparation with protection and convenience

#### Features

- Include components:
  - C31-08AMB 1" FRL with metal bowls and auto drain filter
  - BBLV100 1" brass ball valve and AM12 Air King® on inlet port
  - BBV100DTW 3-way ball valve installed between regulator and lubricator provides option for non-lubricated air
- Heavy duty frame protects air prep components

#### Specifications

- Operating:
  - maximum pressure: 250 PSIG
  - temperature range: 40°F to 150°F (4°C to 66°C)
  - flow: 320 SCFM



F

Size	Part #
1"	C31-08FRAME

### F23-Series Exhaust Muffler

#### Features

- The contaminants in the exhaust flow are mechanically separated and twice filtered to 5 micron levels, the clean, muffled exhaust flows out of the unit under the metal hood on top
- Removes oily aerosols from exhaust flows
- One inlet port
- 5 micron element
- Quick disconnect clamp ring for easy bowl removal
- Manual drain

#### Specifications

- Operating:
  - maximum pressure: 150 PSIG (10.3 bar)
  - temperature range: 32°F to 125°F (0°C to 52°C)

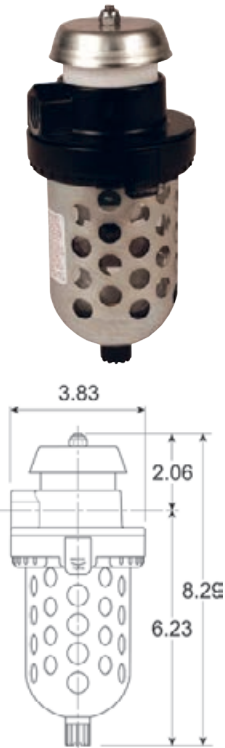

Size	Flow @ 90 PSI	Transparent Bowl with Guard Part #
1/2"	240 SCFM	F23-04M

NOTE: FRLs are designed for air service only, unless otherwise indicated.





## Wilkerson FRLs

### X02-Series Automatic Drains

As liquid contaminants collect in the bowl, they raise a closed-cell cellular float. When the liquid level reaches a given point, the float triggers a mechanism which pilots line pressure against a large area piston or diaphragm which snaps open the drain valve. The contaminants are discharged from the drain orifice at line pressure. As the liquid level falls, the pilot valve closes, line pressure against the piston/diaphragm returns to atmosphere and the drain valve snaps closed.

#### Features

- 5 oz. bowl
- Fully automatic, float operated
- Full 1/2" NPT drain inlet
- Quick-disconnect clamp ring for easy bowl removal when servicing
- No electrical connections
- Easy installation

#### Specifications

- Maximum operating conditions:
  - transparent bowl: 150 PSIG (10.3 bar) and 32°F to 125°F (0°C to 52°C)
  - metal bowl: 200 PSIG (13.8 bar) and 32°F to 150°F (0°C to 66°C)

Size	Transparent Bowl Part #	Metal Bowl Part #
1/2"	X02-04	X02-04MB



with metal bowl

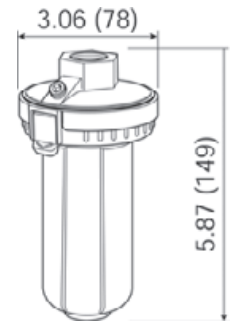

## Lockout Valves

#### Application

- Lockout valves are installed in pneumatic drop legs or individual pneumatic control lines, in accordance with OSHA procedures, lockout valves are used during maintenance and service procedures of pneumatically (air) operated equipment

#### Features

- Used to comply with OSHA 29 CFR part 1910
- Built in port for pressure verification to meet ANSI B11 and Pmm155 requirements
- Inline or surface mountable
- Yellow cast aluminum body with red handle

#### Specifications

- Pressure range: 15-300 PSI
- Temperature range: 40°F to 175°F (4°C to 79°C)



Port In/Out	Port Exhaust	Part #
1/2"	3/4"	LV4N6D
3/4"	3/4"	LV6N6D
3/4"	1-1/4"	LV6NAD
1"	1-1/4"	LV8NAD

**Wilkerson FRLs  
Filter Elements**



FRP-95-115

Used On	Description	Part #
F03	5 micron element	PS403
F08		FRP-96-729
F16		FRP-95-160
F18		FRP-96-639
F26		FRP-95-115
F28		FRP-96-653
F30		FRP-95-209
F35		FRP-95-505
F42		FRP-95-566

**Coalescing Filter Elements**



MTP-95-548

Used On	Description	Part #
M16, M26, M30	type B element (0.5 micron)	MSP-95-989
M16	type C element (0.01 micron)	MTP-95-548
M26	type C element (0.01 micron)	MTP-95-549
M30	type C element (0.01 micron)	MTP-95-551
M35	type C element (0.01 micron)	MTP-95-502

**Desiccant Dryer Gel Refill**



Used On	Description	Part #
X03	8 bags of silica gel refill	DRP-85-059

**Filter Bowls with Drain**



FRP-95-015

Used On	Description	Part #
F08	plastic bowl with guard and manual drain	GRP-96-712
	plastic bowl and metal bowl guard with flex tip drain	FRP-95-014
F16, M16	plastic bowl and metal bowl guard with auto drain	FRP-95-015
	plastic bowl with manual drain	FRP-95-017
	metal bowl with sight glass and manual drain	GRP-95-133
	metal bowl with auto drain	FRP-95-950
	plastic bowl and bowl guard with manual drain	GRP-96-634
F18	plastic bowl and bowl guard with auto drain	GRP-96-635
	metal bowl with sight glass and manual drain	GRP-96-636
	plastic bowl and metal bowl guard with flex tip drain	GRP-95-935
F26, M26	plastic bowl and metal bowl guard with auto drain	GRP-95-948
	metal bowl with sight glass and manual drain	GRP-95-931
	metal bowl with auto drain	GRP-95-960
	plastic bowl, bowl guard, manual drain	GRP-96-642
F28	metal bowl, with sight glass, manual drain	GRP-96-644
	plastic bowl and metal bowl guard with manual drain	FRP-95-832
F30, M30	plastic bowl and metal bowl guard with auto drain	FRP-95-775
	plastic bowl with flex tip drain	FRP-96-315
	metal bowl with sight glass and manual drain	GRP-95-676
	metal bowl with auto drain	GRP-95-970

## Wilkerson FRLs

### Filter Drains

Used On	Description	Part #
F16, F18, F26, F28, F30, F35, M16, M26, M30, M32, M35	automatic drain with flourocarbon seal	GRP-95-981
F16, F18, F26, F28, F30, M16, M26, M30	automatic float drain with a nitrile seal	GRP-95-973
F16, F18, F26, F28, F30, F35, M16, M26, M30, M35	manual override drain	GRP-96-001
F16, F26, F30, M16, M26, M30	manual petcock drain for use with metal bowl units	GRP-95-182
F16, F26, F30, M16, M26, M30	manual flex tip drain	FRP-95-610
F18, F28	manual drain	GRP-96-685



GRP-96-001

F

### Sight Glass Kit

Used On	Description	Part #
M16, M26	sight glass kit for metal bowls	GRP-95-079



### Differential Pressure Indicators

#### Features

- Used to replace damaged indicators on filters and modular coalescing filters
- Pressure loss changes color of indicator window from green to red

Used On	Description	Part #
M16, M26, M30, M32	indicator	DP2-01-000
F35, M35	indicator	DP2-01-001
M18, M28	indicator	DP8-01-000
M18, M28	indicator	DP8-01-001



DP2-01-000

### Ring Style Tamper Resistant Kits

Used On	Description	Part #
R08	ring style tamper resistant kit	RPA-96-735
R16,R26		RPA-95-006
R18		RRP-96-671
R28		RRP-96-672



RPA-95-006

### Wilkerson FRLs Regulator Repair Kits



RRP-95-952

Used On	Description	Part #
R16	self-relieving repair kit	RRP-95-131
R18	relieving diaphragm assembly	RRP-96-656
R26	self-relieving repair kit	RRP-95-952
R28	relieving diaphragm assembly	RRP-96-986
R30	valve assembly: valve, spring, bottom plug O-ring	RRP-95-159
R40	valve assembly: valve, spring, retaining ring O-ring	RRP-95-161

### Lubricator Bowls and Bowl Guards



GRP-95-019

Used On	Description	Part #
L08	plastic bowl with guard and manual drain	LRP-96-736
L16	metal bowl with sight glass and manual drain	GRP-95-133
	plastic bowl with guard and manual drain	GRP-95-019
	plastic bowl with no drain	LRP-96-937
L18	metal bowl with sight glass, manual drain	GRP-96-636
	plastic bowl with guard and manual drain	LRP-96-701
L26	metal bowl with sight glass and manual drain	GRP-95-931
	plastic bowl with no drain	LRP-96-938
L28	metal bowl with sight glass, manual drain	GRP-96-644
	plastic bowl with guard and manual drain	LRP-96-702
L30, L40	metal bowl with sight glass and manual drain	GRP-95-676
L30, L40, L50	plastic bowl with no drain	LRP-96-940

### Sight Domes and Fill Plugs



LRP-95-249

Used On	Description	Part #
L08, L16, L26	sight dome kit: dome and O-ring	LRP-95-239
L08	fill plug kit: fill plug and O-ring	LRP-96-730
L16, L26, L30	fill plug kit: fill plug and O-ring	LRP-95-253
L18, L28	sight dome assembly (new style)	LRP-96-310
L30, L40, L50	sight dome kit: dome and O-ring	LRP-95-249
L40, L50	fill plug kit: fill plug and O-ring	LRP-95-250

### Modular Shut-Off Valves

#### Application

- Useful for isolating and depressurizing a downstream unit requiring maintenance or replacement

#### Features

- Can be installed immediately upstream of a single unit or combination of units
- Secure to the unit with a modular sleeve or modular sleeve wall mounting bracket
- Ball-type valve operates with a 1/4 turn from open to shut position
- Can be locked in the open position
- Left-to-right flow



GPA-95-098

Used On	Description	Part #
F16, F26, R16, B26, L16, L26	1/4" NPT safety shut-off valve	GPA-95-096
	3/8" NPT safety shut-off valve	GPA-95-097
	1/2" NPT safety shut-off valve	GPA-95-098

## Wilkerson FRLs

### Modular Blocks

#### Features

##### Manifold Block

- Flexible installation can be installed after the filter or regulator, providing three additional 1/4" NPT tapped auxiliary ports
- 1/2" inlet/outlet ports non-tapped
- 1-17/32" width

##### End Block

- When used with the modular sleeve, end blocks allow a single unit or a combination of units to be piped into the air system in the modular mode
- Allows ease of unit servicing or replacement without disturbing the air line connections

Used On	Description	Part #
F16, M16, F26, M26, R16, R26, L16, L26	manifold block, three 1/4" NPT auxiliary ports	GPA-95-919
	end block, 1/4" NPT	GPA-95-223
	end block, 3/8" NPT	GPA-95-224
	end block, 1/2" NPT	GPA-95-225
F18, F28, R18, R28, L18, L28	end block, 1/4" NPT	GPA-96-610
	end block, 3/8" NPT	GPA-96-611
	end block, 1/2" NPT	GPA-96-612
	end block, 3/4" NPT	GPA-96-613



GPA-95-919



GPA-95-223

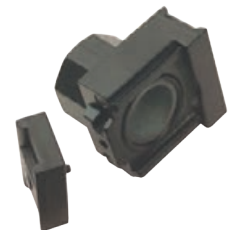

GPA-96-610

### Modular Pipe Adapters

#### Features

- When used with the modular sleeve, adapter inserts allow a single unit or a combination of units to be piped into the air system in the modular mode
- Allows ease of unit servicing or replacement without disturbing the air line connections
- Set includes (2) blocks

Used On	Description	Part #
F16, M16, F26, M26, R16, R26, L16, L26	1/4" NPT	GPA-95-035
	3/8" NPT	GPA-95-036
	1/2" NPT	GPA-95-037



GPA-95-037

### Modular Sleeve

#### Features

- Design easily and quickly connects one or more units and accessories together without pipe nipples
- Hand tightening the threaded pin provides a tight seal between the units

Used On	Description	Part #
F16, F26, R16, R26, L16, L26	modular sleeve	GPA-95-292



### Modular Sleeve with T Bracket

#### Features

- Designed to mount a single unit or combination of units directly to the wall
- Sleeve and mounting bracket can be ordered assembled, or just the mounting bracket alone for use on existing modular sleeves

Used On	Description	Part #
F16, F26, R16, R26, L16, L26	bracket	GPA-95-968
	sleeve and bracket	GPA-95-969



GPA-95-969

**Wilkerson FRLs**  
**Mounting Brackets and Joiner Sets**

Used On Filter/ Regulator/ Lubricator Series	Description	Part #
RB3	mounting bracket (type L) and nut	GRP-95-747
F03	mounting bracket	PS417B
F08	mounting bracket (type T) with joiner set and port O-ring	GPA-96-737
	mounting bracket (type C)	GPA-97-010
	joiner set and port O-ring	GPA-96-738
R08	mounting bracket (type L)	GRP-96-739
F16, M16	mounting bracket (type L)	GPA-95-016
R16	mounting bracket (type L) and nut	GPA-95-011
R16, R21, R26, R30, R40	wall mount bracket with ¼" NPT gauge port adapter	RRP-95-590
F18	body mounting bracket (type L)	GPA-96-604
	bonnet mounting bracket (type L)	GPA-96-606
F18, F28	mounting bracket (type T)	GPA-96-602
	mounting bracket (type T) with joiner set and port O-ring	GPA-96-603
F26, M26	mounting bracket (type L)	GPA-95-946
F28	body mounting bracket (type L)	GPA-96-605
	mounting bracket (type L)	GPA-96-607
F30	wall mount, U-bolt pipe clamp	GRP-95-734



### Series 1 FRLs

#### F07-Series Carded Miniature Filters

**Features**

- 5 micron element
- 1 oz. reservoir
- Transparent bowl

**Specifications**

- Inlet pressure 150 PSI maximum
- Maximum temperature: 125°F (52°C)

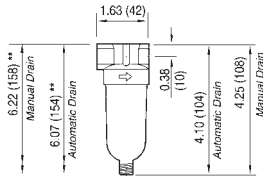

\*\* minimum clearance required to remove bowl

Port Size	Flow (SCFM)	Automatic Drain Part #	Manual Drain Part #
1/4"	24	F07-200AC	F07-200MC



#### R07-Series Carded Miniature Regulator

**Features**

- Relieving type
- Supplied with a GC620 gauge

**Specifications**

- Inlet pressure 250 PSI maximum
- Maximum temperature: 150°F (66°C)
- Pressure range 5-100 PSI

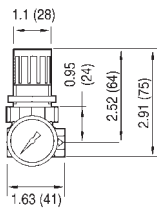

Port Size	Flow (SCFM)	with Gauge Part #
1/4"	15	R07-200GRC



#### L07-Series Carded Miniature Lubricator

**Feature**

- 1 oz. reservoir

**Specifications**

- Inlet pressure 150 PSI maximum
- Maximum temperature: 125°F (52°C)

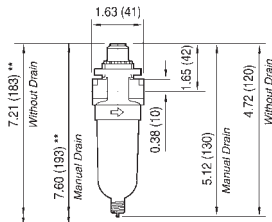

\*\* minimum clearance required to remove bowl

Port Size	Flow (SCFM)	with Transparent Bowl Part #
1/4"	15	L07-200AC



#### B07-Series Carded Miniature Filter/Regulators

**Features**

- Relieving type
- 5 micron element
- 1 oz. reservoir
- Push-to-lock adjusting knob
- Supplied with a GC620 gauge
- Bowl guard not available
- Transparent bowl

**Specifications**

- Pressure range 5-100 PSI
- Inlet pressure 150 PSI maximum
- Maximum temperature: 125°F (52°C)

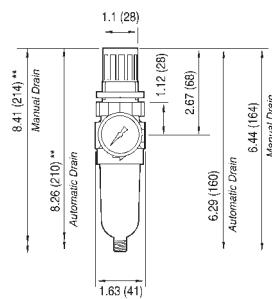

\*\* minimum clearance required to remove bowl

Port Size	Flow (SCFM)	Automatic Drain Part #	Manual Drain Part #
1/4"	14	B07-202AGC	B07-202MGC



NOTE: FRLs are designed for air service only, unless otherwise indicated. SCFM ratings given at 150 PSIG inlet pressure. SCFM ratings given at 100 PSIG inlet pressure for regulators, 90 PSIG all others.

## Series 1 FRLs

### F07-Series Miniature Filters

#### Features

- 5 micron element
- 1 oz. reservoir
- Transparent bowl

#### Specifications

- Inlet pressure **150 PSI** maximum
- Maximum temperature: **125°F (52°C)**



Port Size	Flow (SCFM)	Automatic Drain Part #	Manual Drain Part #
1/8"	19	F07-100A	F07-100M
1/4"	24	F07-200A	F07-200M

NOTE: SCFM ratings given at 90 PSIG inlet pressure.

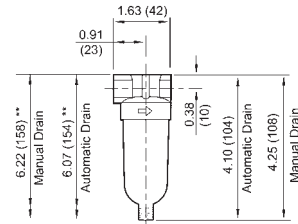

\*\* minimum clearance to remove bowl

F

### R07-Series Miniature Regulators

#### Features

- Relieving type
- RG models supplied with a GC620 gauge
- Panel nut not included

#### Specifications

- Inlet pressure **300 PSI** max.
- Maximum temperature: **150°F (66°C)**
- Regulation at flows up to 22 SCFM at 100 PSIG
- Pressure range **5-100 PSI**



Port Size	Flow (SCFM)	with Gauge Part #	without Gauge Part #
1/8"	14	R07-100RG	R07-100R
1/4"	15	R07-200RG	R07-200R

NOTE: SCFM ratings given at 100 PSIG inlet pressure.

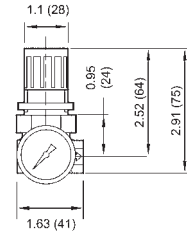

### B07-Series Miniature Filter / Regulators

#### Features

- Relieving type
- 5 micron element
- 1 oz. reservoir
- Push-to-lock adjusting knob
- Supplied with a GC620 gauge
- Bowl guard not available
- Transparent bowl

#### Specifications

- Inlet pressure **150 PSI** maximum
- Maximum temperature: **125°F (52°C)**
- Pressure range **5-100 PSI**



Port Size	Flow (SCFM)	Automatic Drain Part #	Manual Drain Part #
1/8"	13	B07-102AG	B07-102MG
1/4"	24	B07-202AG	B07-202MG

NOTE: SCFM ratings given at 150 PSIG inlet pressure.

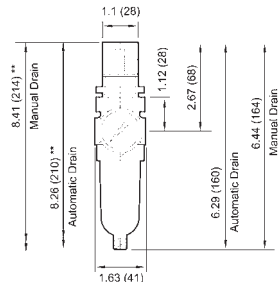

\*\* minimum clearance to remove bowl

### L07-Series Miniature Lubricators

#### Feature

- 1 oz. reservoir

#### Specifications

- Inlet pressure **150 PSI** maximum
- Maximum temperature: **125°F (52°C)**



Port Size	Flow (SCFM)	Transparent Bowl Part #
1/8"	10	L07-100A
1/4"	14	L07-200A

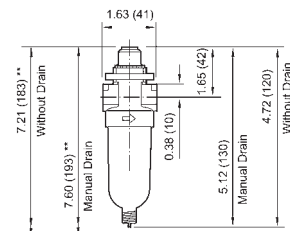

\*\* minimum clearance to remove bowl



## Series 1 FRLs

### P1A-Series Miniature Combination Units

#### Features

- 1 oz. reservoir
- Supplied with a GC620 gauge
- Transparent bowl

#### Specifications

- Inlet pressure **150 PSI** maximum
- Maximum temperature: **125°F (52°C)**
- Pressure range: **5-125 PSI**

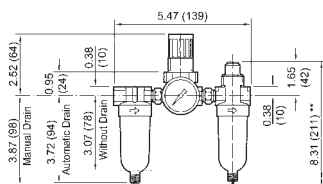

\*\* minimum clearance to remove bowl

Port Size	Flow (SCFM)	Automatic Drain Part #	Manual Drain Part #
1/8"	10	P1A-100A	P1A-100M
1/4"	14	P1A-200A	P1A-200M

### PTH-Series Miniature Combination Units

#### Features

- Transparent bowl
- Requires only two pipe connections

#### Specifications

- Inlet pressure **150 PSI** maximum
- Maximum temperature: **125°F (52°C)**
- Pressure range: **5-125 PSI**

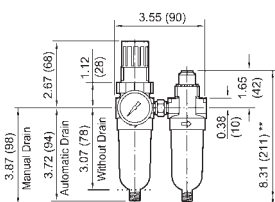

\*\* minimum clearance to remove bowl

Port Size	Flow (SCFM)	Automatic Drain Part #
1/8"	10	PTH-100AG
1/4"	14	PTH-200AG

### F72-Series Sub-Compact Airline Filters

#### Features

- Particle removal per ISO 8573-1, Class 5, and Class 3
- 40 micron element
- 2 oz. reservoir
- Quick-release bayonet bowl
- Prismatic lens liquid level indicator

#### Specifications

- Inlet pressure:
  - transparent bowl: **150 PSI** and **125°F (52°C)**
  - metal bowl: **250 PSI** and **150°F (66°)**



with transparent bowl

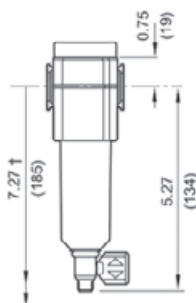

† Minimum clearance to remove bowl

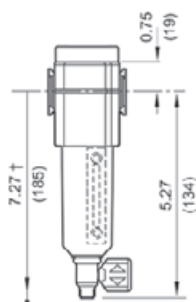

† Minimum clearance to remove bowl

#### Transparent Bowl

Port Size	Flow (SCFM)	Semi-Automatic Drain Part #	Manual Drain Part #
1/4"	55	F72G-2A	F72G-2M

#### Metal Bowl and Sight Glass

Port Size	Flow (SCFM)	Semi-Automatic Drain Part #	Manual Drain Part #
1/4"	55	F72G-2A-MB	F72G-2M-MB



with metal bowl

NOTE: SCFM ratings at 100 PSIG inlet pressure for regulators, 90 PSIG all others. FRLs are designed for air service only, unless otherwise indicated.

**Series 1 FRLs**

**F73-Series Compact Airline Filters**

**Features**

- Particle removal per ISO 8573-1, Class 5, and Class 3
- 40 micron element
- 4 oz. reservoir
- Quick-release bayonet bowl
- Prismatic lens liquid level indicator

**Specifications**

- Inlet pressure:
  - transparent bowl: **150 PSI** and **125°F (52°C)**
  - metal bowl: **250 PSI** and **175°F (79°C)**

**Transparent Bowl**

Port Size	Flow (SCFM)	Automatic Drain Part #	Manual Drain Part #
1/4"	53	F73G-2A	F73G-2M
3/8"	65	F73G-3A	F73G-3M
1/2"	69	F73G-4A	F73G-4M

**Metal Bowl and Sight Glass**

Port Size	Flow (SCFM)	Automatic Drain Part #	Manual Drain Part #
1/4"	53	F73G-2A-MB	F73G-2M-MB
3/8"	65	F73G-3A-MB	F73G-3M-MB
1/2"	69	F73G-4A-MB	F73G-4M-MB



with transparent bowl



with metal bowl

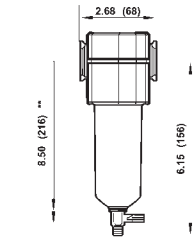

\*\* Minimum clearance required to remove bowl.

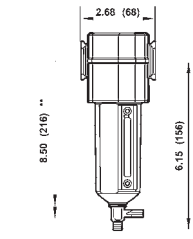

\*\* Minimum clearance required to remove bowl.

**F74-Series Standard Airline Filters**

**Features**

- Particle removal per ISO 8573-1, Class 5, and Class 3
- 40 micron element
- 7 oz. reservoir
- Quick-release bayonet bowl
- Prismatic lens liquid level indicator

**Specifications**

- Inlet pressure:
  - transparent bowl: **150 PSI** and **125°F (52°C)**
  - metal bowl: **250 PSI** and **175°F (79°C)**

**Transparent Bowl and Guard**

Port Size	Flow (SCFM)	Automatic Drain Part #	Manual Drain Part #
3/8"	112	F74G-3A	F74G-3M
1/2"	140	F74G-4A	F74G-4M
3/4"	140	F74G-6A	F74G-6M

**Metal Bowl and Sight Glass**

Port Size	Flow (SCFM)	Automatic Drain Part #	Manual Drain Part #
3/8"	112	F74G-3A-MB	F74G-3M-MB
1/2"	140	F74G-4A-MB	F74G-4M-MB
3/4"	140	F74G-6A-MB	F74G-6M-MB



with transparent bowl



with metal bowl

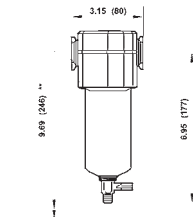

\*\* Minimum clearance required to remove bowl.

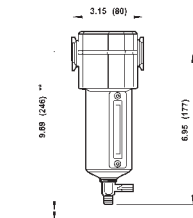

\*\* Minimum clearance required to remove bowl.

NOTE: See pages 333 to 338 for accessories.  
 FRLs are designed for air service only, unless otherwise indicated.  
 SCFM ratings at 90 PSIG inlet pressure.



### Series 1 FRLs

#### F17-Series Jumbo Airline Filters

**Features**

- General purpose with low pressure drop and excellent water removal characteristics
- 40 micron element
- 1 qt. reservoir

**Specifications**

- Inlet pressure: 250 PSI and 175°F (79°C)

**Metal Bowl and Sight Glass**

Port Size	Flow (SCFM)	Automatic Drain Part #	Manual Drain Part #
3/4"	325	F17-600A	F17-600M
1"	425	F17-800A	F17-800M
1-1/4"	425	F17-A00A	F17-A00M
1-1/2"	425	F17-B00A	F17-B00M

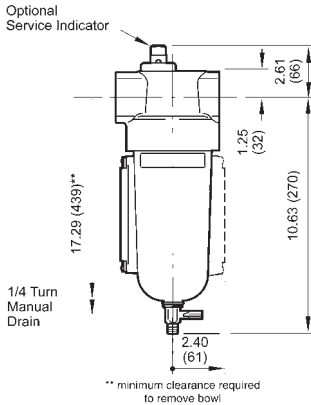

**Features**

- 40 micron element
- Quick-release bayonet bowl
- Prismatic lens liquid level indicator
- 7 oz. reservoir

**Specifications**

- Inlet pressure: 250 PSI and 175°F (79°C)

**Metal Bowl and Sight Glass**

Port Size	Flow (SCFM)	Automatic Drain Part #	Manual Drain Part #
2"	1400	F18-C00A	F18-C00M

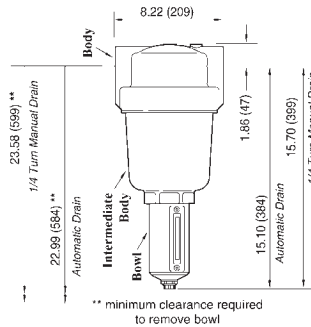

#### F74-Series Oil Removal Filters

**Features**

- Provides air quality class 2 hydrocarbon and class 1 particulate removal per ISO 8573-1
- Element removes particles down to 0.01mm. Maximum remaining oil content of air leaving the filter is 0.01 ppm at 70°F (21°C) with an inlet concentration of 8 ppm
- For maximum service life install a general purpose filter upstream of the oil removal filter
- Service life indicator turns from green to red when element needs to be replaced
- In-line or modular installation
- Quick-release bayonet bowl
- Prismatic lens liquid level indicator

**Specifications**

- Inlet pressure: 250 PSI and 150°F (66°C)

Port Size	Flow (SCFM) Saturated	SCFM Dry	Automatic Drain Part #
3/8"	35	70	F74C-3A-MB
1/2"	35	75	F74C-4A-MB
1/2"	60	100	F74H-4A-MB
3/4"	60	120	F74H-6A-MB

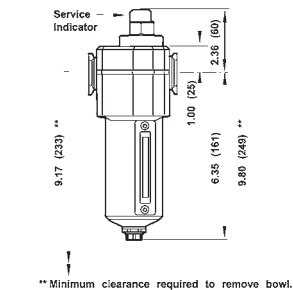

NOTE: See pages 333 to 338 for accessories.  
 FRLs are designed for air service only, unless otherwise indicated.  
 SCFM ratings at 90 PSIG inlet pressure.



## Series 1 FRLs

### F74-Series Oil Vapor Removal Filters

#### Features

- Provides air quality class 1 particulate removal per ISO 8573-1, when used with the F74C series
- For maximum service life install a general purpose filter and an oil removal filter upstream of the oil vapor removal filter
- Carbon cartridge element provides long service life
- Activated carbon cartridge filter element absorbs oil vapors and removes most hydrocarbon odors
- In-line or modular installation
- Quick-release bayonet bowl
- Metal bowl

#### Specifications

- Inlet pressure: **250 PSI** and **150°F (66°C)**
- Filter and element designs optimizes air velocity and contact time to reduce oil content of air leaving the filter to 0.003 ppm at **70°F (21°C)**
- Minimum service life of 400 hours can be expected if the vapor removal filter is protected upstream by an oil removal (coalescing) filter and if the filtration temperature is in the region of **70° to 80°F (21° to 26°C)**, above this range, oil vapor content of compressed air increases substantially and element service life is reduced

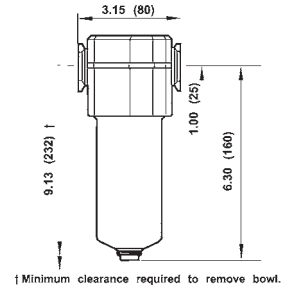

Port Size	Flow (SCFM)	Automatic Drain with Metal Bowl Part #
3/8"	21	F74V-3A-MB
1/2"	21	F74V-4A-MB

NOTE: SCFM ratings at 90 PSIG inlet pressure.

F

## Series 1 FRLs

### R72-Series Sub-Compact Regulators

#### Features

- In-line or modular installation
- Two full flow 1/8" NPT gauge ports
- RG models supplied with GC620 gauge

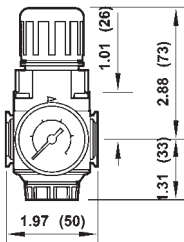

#### Specifications

- To order **0-60 PSI** range consult Dixon®
- Pressure range: **5-150 PSI**
- Inlet pressure: **300 PSI**
- Maximum temperature: **150°F (66°C)**

Port Size	Flow (SCFM)	with Gauge Part #	without Gauge Part #
1/4"	70	R72G-2RG	R72G-2R
3/8"	70	R72G-3RG	R72G-3R



F

### R73-Series Compact Regulators

#### Features

- In-line or modular installation
- Relieving type
- Two full flow 1/4" NPT gauge ports
- RG models supplied with GC230 gauge

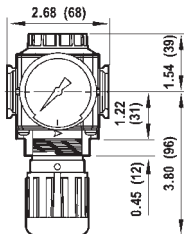

#### Specifications

- To order **0-60 PSI** range consult Dixon
- Pressure range: **5-150 PSI**
- Inlet pressure: **300 PSI**
- Maximum temperature: **150°F (66°C)**

Port Size	Flow (SCFM)	with Gauge Part #	without Gauge Part #
1/4"	91	R73G-2RG	R73G-2R
3/8"	144	R73G-3RG	R73G-3R
1/2"	144	R73G-4RG	R73G-4R



NOTE: SCFM ratings given at 150 PSIG inlet pressure  
 FRLs are designed for air service only, unless otherwise indicated.   
 See pages 333 to 338 for accessories.

## Series 1 FRLs

### R74-Series Standard Regulators



#### Features

- In-line or modular installation
- Relieving type
- Two full flow 1/4" NPT gauge ports
- RG models supplied with GC230 gauge

#### Specifications

- Pressure range: **5-150 PSI**
- Inlet pressure: **300 PSI**
- Maximum temperature: **150°F (66°C)**
- To order **0-60 PSI** range consult Dixon®.

Port Size	Flow (SCFM)	with Gauge Part #	without Gauge Part #
3/8"	208	R74G-3RG	R74G-3R
1/2"	220	R74G-4RG	R74G-4R
3/4"	220	R74G-6RG	R74G-6R

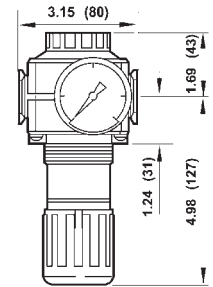

### R17, R18-Series Jumbo Regulators



#### Features

- In-line or modular installation
- Relieving type
- Two full-flow 1/4" NPT gauge ports
- RG models supplied with GC230 gauge

#### Specifications

- Pressure range: **5-125 PSI**
- Inlet pressure: **300 PSI**
- Maximum temperature: **175°F (79°C)**

Port Size	Flow (SCFM)	with Gauge Part #	without Gauge Part #
3/4"	440	R17-600RG	R17-600R
1"	480	R17-800RG	R17-800R
1-1/4"	400	R17-A00RG	R17-A00R
1-1/2"	440	R17-B00RG	R17-B00R

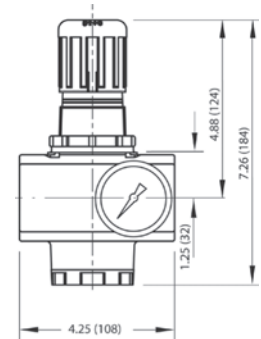

NOTE: SCFM ratings given at 150 PSIG inlet pressure



#### Features

- Relieving type
- Two full flow 1/4" NPT gauge ports
- RG model supplied with GC230 gauge

#### Specifications

- **5-125 PSI** range
- Inlet pressure: **450 PSI**
- Maximum temperature: **175°F (79°C)**

Port Size	Flow (SCFM)	with Gauge Part #	without Gauge Part #
2"	2000	R18-C05RG	R18-C05R

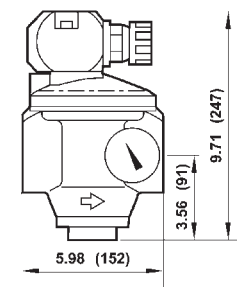

NOTE: SCFM ratings given at 100 PSIG inlet pressure

### R11-Series General T-Handle Regulators

Floating valve pin provides positive seating and dependability. Large diaphragm provides quick response to flow demands and line pressure changes. Balanced valve reduces inlet pressure variations on outlet pressure.



#### Features

- T-handle adjustment
- Supplied with GC620 gauge

#### Specifications

- Pressure range: **5-125 PSI**
- Inlet pressure: **400 PSI**
- Maximum temperature: **175°F (79°C)**

Port Size	Flow (SCFM)	with Gauge Part #
1/4"	110	R11-013RG
3/8"	110	R11-037RG
1/2"	260	R11-061RG

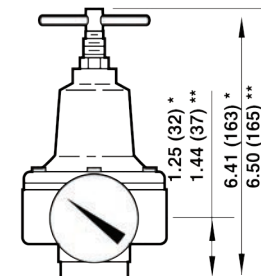

NOTE: SCFM ratings given at 150 PSIG inlet pressure

FRLs are designed for air service only, unless otherwise indicated. See pages 333 to 338 for accessories.



## Series 1 FRLs

### R72-Series Manifold Regulators

Manifold up to six regulators on a single air supply. Design allows in-line installation with hex nipple or modular installation with 72 series accessories.

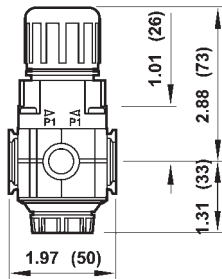

**Feature**

- RG models supplied with GC620 gauge

**Specifications**

- Pressure range: **5-150 PSI**
- Inlet pressure: **300 PSI**
- Maximum temperature: **150°F (66°C)**

Port Size	Flow (SCFM)	with Gauge Part #	without Gauge Part #
1/4"	83	R72M-2RG	R72M-2R
3/8"	83	R72M-3RG	R72M-3R

NOTE: SCFM ratings at 150 PSIG.



F

### R83-Series Cylinder Gas Regulator

**Applications**

- UL listed for service with carbon dioxide, water, pumped air, nitrogen, argon, helium, krypton, neon, and xenon
- *Not to be used with flammable gases*



**Features**

- Relieving type
- Two ports for high pressure and two ports for service

**Specifications**

- Pressure range: **5-125 PSI**
- Inlet pressure: **3,000 PSI**
- Maximum temperature: **140°F (60°C)**

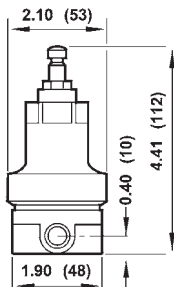

Port Size	Flow (SCFM)	without Gauge Part #
1/4"	10	R83-200R

NOTE: SCFM ratings given at 1000 PSIG inlet pressure.



### R91-Series Miniature Water Regulator

**Application**

- Designed for use with deionized water and potable water systems, plastic and metal components in contact with fluid are approved by the National Sanitation Foundation (NSF) or meet Food and Drug Administration (FDA) recommendations for use in potable water systems

**Features**

- Non-relieving type
- Supplied with GC620 gauge
- Food grade elastomers

**Specifications**

- Inlet pressure: **150 PSI**
- Maximum temperature: **125°F (52°C)**
- Pressure range **5-50 PSIG**

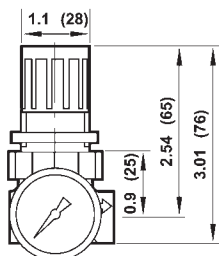

Port Size	Flow (GPM)	with Gauge Part #
1/4"	<b>1.75</b>	R91-221RG

NOTE: SCFM ratings given at 100 PSIG inlet pressure  
 FRLs are designed for air service only, unless otherwise indicated.  
 See pages 333 to 338 for accessories.



Series 1 FRLs

R43-Series Water Pressure Regulators

Application

- Used in water systems to reduce and maintain pressure at a nearly constant level despite changes in the inlet pressure and changes in downstream flow requirements

Features

- T-handle adjustment
- Brass body and aluminum bonnet
- Non-relieving type
- Gauge port is full-flow and can be used as an outlet port
- Supplied with GC230 gauge

Specifications

- Pressure range: 5-125 PSI
- Inlet pressure: 400 PSI
- Temperature range:
  - water service: 35° to 200°F (2°C to 93°C)
  - air service: -30° to 200°F (-34°C to 93°C)

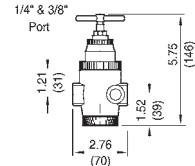
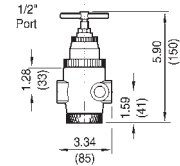

Port Size	Flow (GPM)	with Gauge Part #
1/4"	5	R43-201RG
3/8"	5	R43-301RG
1/2"	10	R43-406RG

11-009-Series Water Regulators

Application

- Balanced valve minimizes effects of the inlet pressure variations on outlet pressure

Features

- T-handle adjustment
- Non-relieving type
- Body, valve, and bottom plug are brass; bonnet is aluminum and steel
- Elastomers are nitrile

Specifications

- Inlet pressure: 400 PSI
- Temperature range:
  - water service: 35° to 200°F (2° to 93°C)
  - air service: -30° to 200°F (-34° to 93°C)
- Pressure range: 5-125 PSIG

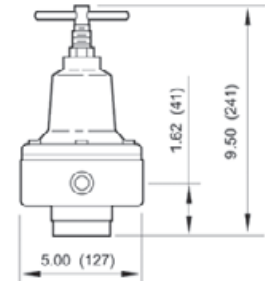

Port Size	Flow (GPM)	without Gauge Part #
3/4"	27.5	11-009-065
1"	27.5	11-009-081

B72-Series Sub-Compact Filter / Regulators

Features

- Particle removal per ISO 8573-1, Class 5, and Class 3
- In-line or modular installation
- 40 micron element
- 2 oz. reservoir
- Quick-release bayonet bowl
- Prismatic lens liquid level indicator
- Supplied with GC620 gauge

Specifications

- Pressure range: 5-150 PSI
- Inlet pressure:
  - transparent bowl: 150 PSI and 125°F (52°C)
  - metal bowl: 250 PSI and 150°F (66°C)



with transparent bowl

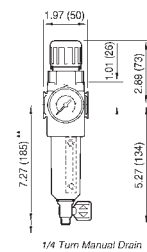

\*\* minimum clearance required to remove bowl

Transparent Bowl

Port Size	Flow (SCFM)	Semi-Automatic Drain Part #	Manual Drain Part #
1/4"	80	B72G-2AG	B72G-2MG

Metal Bowl and Sight Glass

Port Size	Flow (SCFM)	Semi-Automatic Drain Part #	Manual Drain Part #
1/4"	80	B72G-2AG-MB	B72G-2MG-MB
3/8"		B72G-3AG-MB	B72G-3MG-MB

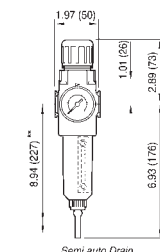

\*\* minimum clearance required to remove bowl



with metal bowl

NOTE: SCFM ratings given at 150 PSIG inlet pressure  
 FRLs are designed for air service only, unless otherwise indicated.  
 See pages 333 to 338 for accessories.





## Series 1 FRLs

### B73-Series Compact Filters / Regulators

#### Features

- Particle removal per ISO 8573-1, Class 5, and Class 3
- In-line or modular installation
- 40 micron element
- 3.5 oz. reservoir
- Quick-release bayonet bowl
- Prismatic lens liquid level indicator
- Supplied with GC230 gauge

#### Specifications

- Pressure range: **5-150 PSI**
- Inlet pressure:
  - transparent bowl: **150 PSI and 125°F (52°C)**
  - metal bowl: **250 PSI and 175°F (79°C)**

#### Transparent Bowl

Port Size	Flow (SCFM)	Automatic Drain Part #	Manual Drain Part #
1/4"	78	B73G-2AG	B73G-2MG
3/8"	123	B73G-3AG	B73G-3MG
1/2"	123	B73G-4AG	B73G-4MG

#### Metal Bowl and Sight Glass

Port Size	Flow (SCFM)	Automatic Drain Part #	Manual Drain Part #
1/4"	78	B73G-2AG-MB	B73G-2MG-MB
3/8"	123	B73G-3AG-MB	B73G-3MG-MB
1/2"	123	B73G-4AG-MB	B73G-4MG-MB

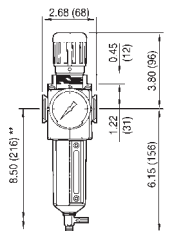

1/4 Turn Manual Drain  
\*\* minimum clearance required to remove bowl

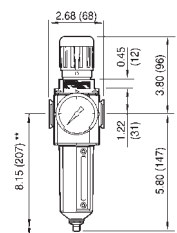

Automatic Drain  
\*\* minimum clearance required to remove bowl

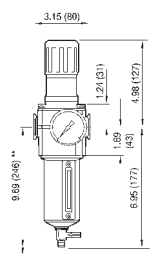

Manual Drain  
\*\* minimum clearance required to remove bowl

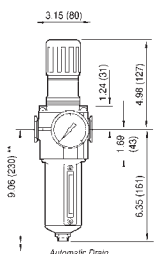

Automatic Drain  
\*\* minimum clearance required to remove bowl

### B74-Series Standard Filters / Regulators

#### Features

- 40 micron element
- 7 oz. reservoir
- Relieving type
- Supplied with GC230 gauge

#### Specifications

- Pressure range: **5-150 PSI**
- Inlet pressure:
  - transparent bowl: **5-150 PSI and 125°F (52°C)**
  - metal bowl: **5-250 PSI and 175°F (79°C)**

#### Transparent Bowl and Guard

Port Size	Flow (SCFM)	Automatic Drain Part #	Manual Drain Part #
1/2"	212	B74G-4AG	B74G-4MG
3/4"	212	B74G-6AG	B74G-6MG

#### Metal Bowl and Sight Glass

Port Size	Flow (SCFM)	Automatic Drain Part #	Manual Drain Part #
3/8"	163	B74G-3AG-MB	B74G-3MG-MB
1/2"	212	B74G-4AG-MB	B74G-4MG-MB
3/4"	212	B74G-6AG-MB	B74G-6MG-MB

NOTE: SCFM ratings given at 150 PSIG inlet pressure

FRLs are designed for air service only, unless otherwise indicated.  
See pages 333 to 338 for accessories.



with transparent bowl



with metal bowl



with guard



with metal bowl

F



Automatic

**Series 1 FRLs**

**B17-Series Filter / Regulator**

**Features**

- 5 micron
- 1 qt. reservoir
- Supplied with gauge

**Specification**

- Adjusting pressure range 5-125 PSI

Port Size	Flow (SCFM)	Automatic Part #	Manual Part #
1"	650	B17-08AGMB	B17-08MGMB

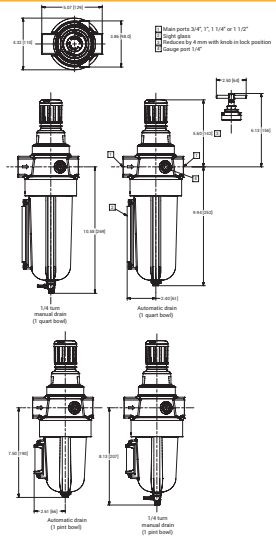

**L72-Series Sub-Compact Micro-Fog Lubricators**

**Application**

- Micro-fog lubricators, identified by a red adjusting screw, are used for applications containing one or more points of lubrication, cylinders, and multiple or single tools
- Air flow through the lubricator lifts oil from the reservoir to the sight-feed dome; oil is dropped into the fog generator and atomized into a fine mist; lightweight particles are delivered downstream for lubrication; heavier particles fall back into the reservoir
- The micro-fog lubricator delivers 10% of the oil drops visible through the transparent sight-feed dome
- Micro-fog lubricators cannot be filled under pressure



with transparent bowl

**Features**

- 2 oz. reservoir
- In-line or modular installation
- Quick release bayonet bowl
- Micro-fog design delivers aerosol mist

**Specifications**

- Recommended lubricants: misting type oil rated 50 to 200 SSU (ISO Grade 7 to 46) at 100°F (38°C)
- Maximum operating conditions:
  - transparent bowl: 150 PSI and 125°F (52°C)
  - metal bowl: 250 PSI and 175°F (79°C)

Port Size	Flow (SCFM)	Transparent Bowl Part #	Metal Bowl Part #
1/4"	51	L72M-2	L72M-2MB

NOTE: SCFM ratings given at 90 PSIG inlet pressure.

**L73-Series Compact Micro-Fog Lubricators**

**Features**

- 4 oz. reservoir
- In-line or modular installation
- Quick release bayonet bowl
- Micro-fog design delivers aerosol mist

**Specifications**

- Recommended lubricants: misting type oil rated 50 to 200 SSU (ISO Grade 7 to 46) at 100°F (38°C)
- Maximum operating conditions:
  - transparent bowl: 150 PSI and 125°F (52°C)
  - metal bowl: 250 PSI and 175°F (79°C)

Port Size	Flow (SCFM)	Transparent Bowl Part #	Metal Bowl Part #
1/4"	70	L73M-2	L73M-2MB
3/8"	70	L73M-3	L73M-3MB
1/2"	70	L73M-4	L73M-4MB

NOTE: SCFM ratings given at 90 PSIG inlet pressure  
 FRLs are designed for air service only, unless otherwise indicated.  
 See pages 333 to 338 for accessories.

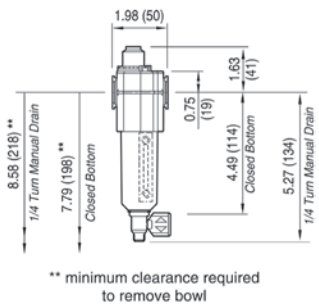

\*\* minimum clearance required to remove bowl



with transparent bowl

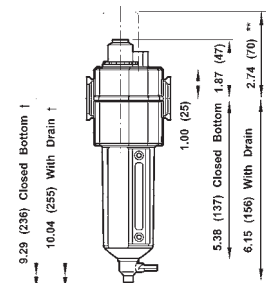

## Series 1 FRLs

### Applications

- Micro-fog lubricators, identified by a red adjusting screw, are used for applications containing one or more points of lubrication, cylinders, and multiple or single tools

### Features

- Air flow through the lubricator lifts oil from the reservoir to the sight-feed dome; oil is dropped into the fog generator and atomized into a fine mist; lightweight particles are delivered downstream for lubrication; heavier particles fall back into the reservoir
- The micro-fog lubricator delivers 10% of the oil drops visible through the transparent sight-feed dome
- Micro-fog lubricators cannot be filled under pressure



### L74-Series Standard Micro-Fog Lubricators

#### Features

- 7 oz. reservoir
- In-line or modular installation
- Quick release bayonet bowl
- Micro-fog design delivers aerosol mist

#### Specifications

- Recommended lubricants: misting type oil rated 50 to 200 SSU (ISO Grade 7 to 46) at 100°F (38°C)
- Maximum operating conditions:
  - transparent bowl: 150 PSI and 125°F (52°C)
  - metal bowl: 250 PSI and 175°F (79°C)

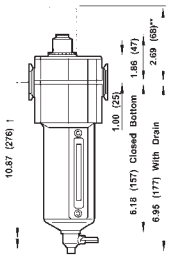

\*\* Optional pyrex sight-feed dome.  
1 Minimum clearance required to remove bowl.

Port Size	Flow (SCFM)	Transparent Bowl Part #	Metal Bowl Part #
3/8"	114	L74M-3	L74M-3MB
1/2"	154	L74M-4	L74M-4MB
3/4"	142	L74M-6	L74M-6MB



transparent bowl

NOTE: SCFM ratings given at 90 PSIG inlet pressure.

### L17-Series Jumbo Micro-Fog Lubricators

#### Features

- 1 qt. reservoir
- Oil level sight gauge
- One turn threaded bowl attachment permits easy maintenance

#### Specifications

- Inlet pressure: 250 PSI
- Maximum temperature: 175°F (79°C)

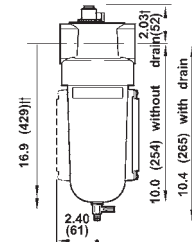

1 quart US (1 liter) reservoir  
1/4 turn drain

Port Size	Flow (SCFM)	Metal Bowl with Sight Glass Part #
3/4"	160	L17-600A
1"	275	L17-800A
1-1/4"	275	L17-A00A
1-1/2"	275	L17-B00A



NOTE: SCFM ratings given at 90 PSIG inlet pressure.

### 10-076-Series Jumbo General Purpose Oil-Fog Lubricators

#### Features

- 2 gallon reservoir
- Oil flow can be positively set
- Reservoir is ASME constructed
- Oil level sight gauge

#### Specifications

- Inlet pressure: 250 PSI
- Maximum temperature: 175°F (79°C)



2 and 5 gallon (8 and 20 liter) reservoir  
\*\* Optional pyrex sight-feed dome.  
1 Minimum clearance required to remove bowl

Port Size	Flow (SCFM)	Metal Bowl with Sight Glass Part #
2"	1000	10-076-004



NOTE: SCFM ratings given at 100 PSIG inlet pressure.

See pages 333 to 338 for accessories.

See page 267 for air tool lubricant.

FRLs are designed for air service only, unless otherwise indicated.



## Series 1 FRLs

### Micro-Fog Lubricator with Pyrex Sight Feed Dome

**Applications**

- Designed for use with alcohol or other anti-freeze agents when units are installed in cold temperature environments
- Micro-fog lubricators are used for applications containing one or more points of lubrication, cylinders, and multiple or single tools
- Air flow through the lubricator lifts oil from the reservoir to the sight-feed dome; oil is dropped into the fog generator and atomized into a fine mist; lightweight particles are delivered downstream for lubrication; heavier particles fall back into the reservoir

**Features**

- High-pressure sight feed dome with aluminum case and fluorocarbon O-rings and seals; high pressure sight glass on bowls and metal petcock drain
- The micro-fog lubricator delivers 10% of the oil drops visible through the transparent sight-feed dome
- Micro-fog lubricators cannot be filled under pressure



#### L73-Series Compact

**Features**

- 4 oz. reservoir
- In-line or modular installation
- Quick release bayonet bowl
- Micro-fog design delivers aerosol mist

**Specifications**

- Recommended lubricants: misting type oil rated 50 to 200 SSU (ISO Grade 7 to 46) at **100°F (37°C)**
- Inlet pressure: **250 PSI**
- Maximum temperature: **175°F (79°C)**



Port Size	Flow (SCFM)	Metal Bowl with Sight Glass Part #
3/8"	60	L73M-3MBPX
1/2"	60	L73M-4MBPX

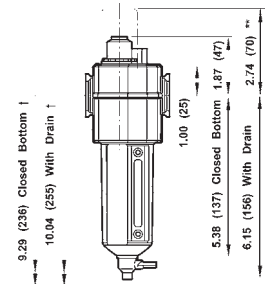

#### L74-Series Standard

**Features**

- 7 oz. reservoir
- In-line or modular installation
- Quick release bayonet bowl
- Micro-fog design delivers aerosol mist

**Specifications**

- Recommended lubricants: misting type oil rated 50 to 200 SSU (ISO Grade 7 to 46) at **100°F (37°C)**
- Inlet pressure: **250 PSI**
- Maximum temperature: **175°F (79°C)**



Port Size	Flow (SCFM)	Metal Bowl with Sight Glass Part #
3/8"	114	L74M-3MBPX
1/2"	154	L74M-4MBPX
3/4"	142	L74M-6MBPX

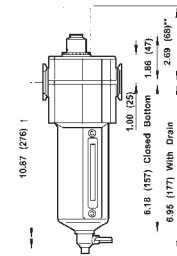

\*\* Optional pyrex sight-feed dome.  
† Minimum clearance required to remove bowl.

#### L17-Series Jumbo

**Features**

- 1 qt. reservoir
- Oil level sight gauge
- Particle removal per ISO 8573-1, class 5 and class 3
- One turn threaded bowl attachment permits easy maintenance

**Specifications**

- Inlet pressure: **250 PSI**
- Maximum temperature: **175°F (79°C)**



Port Size	Flow (SCFM)	Metal Bowl with Sight Glass Part #
1"	275	L17-800APX

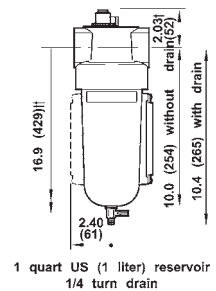

1 quart US (1 liter) reservoir  
1/4 turn drain

NOTE: SCFM ratings given at 90 PSIG inlet pressure.  
See pages 333 to 338 for accessories.  
See page 267 for air tool lubricant.  
FRLs are designed for air service only, unless otherwise indicated.



F

## Series 1 FRLs

### L74-Series Standard Oil-Fog Lubricators

#### Application

- Oil-fog lubricators, identified by a green adjusting screw, are used for lubricating a single air tool or air motor and should be installed as near the device as possible

#### Features

- All the oil visible dropping through the transparent sight-feed dome goes to the airstream
- L72C, L73C, and L74C OIL-FOG lubricators can be filled under pressure
- In-line or modular installation
- Quick-release bayonet bowl
- Can be filled under pressure
- 7 oz. reservoir

#### Specifications

- Maximum operating conditions:
  - transparent bowl: **150 PSI and 125°F (52°C)**
  - metal bowl: **250 PSI and 175°F (79°C)**
- Recommended lubricants: misting type oil rated 50 to 200 SSU (ISO Grade 7 to 46) at **100°F (37°C)**

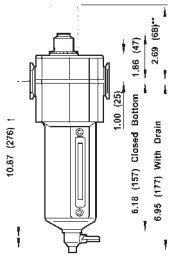

\*\* Optional pyrex sight-feed dome.  
† Minimum clearance required to remove bowl.



metal bowl

Port Size	Flow (SCFM)	Transparent Bowl Part #	Metal Bowl Part #
3/8"	118	L74C-3	L74C-3MB
1/2"	192	L74C-4	L74C-4MB
3/4"	186	L74C-6	L74C-6MB

### L17-Series Jumbo Oil-Fog Lubricators

#### Application

- Oil-fog lubricators, identified by a green adjusting screw, are used for lubricating a single air tool or air motor and should be installed as close to the device as possible

#### Features

- 1 qt. reservoir
- Oil level sight gauge
- All the oil visible dropping through the transparent sight-feed dome goes to the airstream
- One-turn threaded bowl attachment permits easy maintenance

#### Specifications

- Inlet pressure: **250 PSI**
- Maximum temperature: **175°F (79°C)**

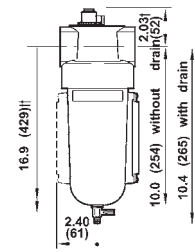

1 quart US (1 liter) reservoir  
1/4 turn drain



metal bowl

Port Size	Flow (SCFM)	Metal Bowl with Sight Glass Part #
3/4"	160	L17-600D
1"	275	L17-800D
1-1/2"	275	L17-B00D

NOTE: SCFM ratings given at 90 PSIG inlet pressure.

See pages 333 to 338 for accessories.

See page 267 for air tool lubricant.

FRLs are designed for air service only, unless otherwise indicated.



**Series 1 FRLs**

**E73-Series Compact Combination Units**

**Features**

- 4 oz. reservoir
- Supplied with a G230 gauge
- Connected modularly
- Includes (2) clamps and wall mounting brackets # 4314-52, (2) clamps # 4314-51, and (2) NPT pipe adapters #4315-01.

**Specifications**

- 5-150 PSI range
- Inlet pressure:
  - transparent bowl: 150 PSI and 125°F (52°C)
  - metal bowl: 250 PSI and 175°F (79°C)

**Transparent Bowl**

Port Size	Flow (SCFM)	Automatic Drain Part #	Manual Drain Part #
1/4"	70	E73-2A	E73-2M
3/8"	70	E73-3A	E73-3M
1/2"	70	E73-4A	E73-4M

**Metal Bowl**

Port Size	Flow (SCFM)	Automatic Drain Part #	Manual Drain Part #
3/8"	70	E73-3A-MB	E73-3M-MB
1/2"	70	E73-4A-MB	E73-4M-MB

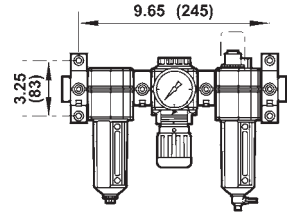

metal bowls

F

**E74-Series Standard Combination Units**

**Features**

- 7 oz. reservoir
- Models supplied with a GC230 gauge
- Connected modularly
- Includes (2) clamps and wall mounting brackets # 4314-52, (2) clamps # 4314-51, and (2) NPT pipe adapters

**Specifications**

- Inlet pressure:
  - transparent bowl: 150 PSI and 125°F (52°C)
  - metal bowl: 250 PSI and 175°F (79°C)
- Pressure range: 5-150 PSI

**Transparent Bowl and Guard**

Port Size	Flow (SCFM)	Automatic Drain Part #	Manual Drain Part #
1/2"	150	E74-4A	E74-4M
3/4"	140	E74-6A	E74-6M

**Metal Bowl and Sight Glass**

Port Size	Flow (SCFM)	Automatic Drain Part #	Manual Drain Part #
3/8"	110	E74-3A-MB	E74-3M-MB
1/2"	150	E74-4A-MB	E74-4M-MB
3/4"	140	E74-6A-MB	E74-6M-MB

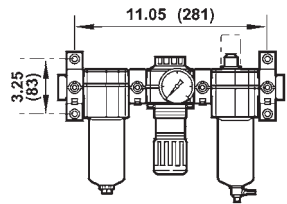

transparent bowl with guard

**P8A Jumbo Combination Units**

**Features**

- 1 qt. reservoir

**Specifications**

- Pressure range: 5-125 PSI
- Inlet pressure: 250 PSI
- Maximum temperature: 175°F (79°C)

**Metal Bowl and Sight Glass**

Port Size	Flow (SCFM)	Automatic Drain Part #	Manual Drain Part #
1"	275	P8A-860A	P8A-860M

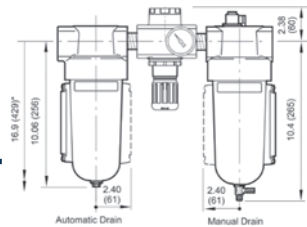

\* Minimum clearance required to remove bowl.



with metal bowls

NOTE: SCFM ratings given at 90 PSIG inlet pressure.  
FRLs are designed for air service only, unless otherwise indicated.



### Series 1 FRLs

#### 17-016-Series Drip Leg Automatic Drain

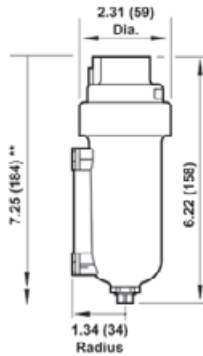

\*\* Minimum clearance to remove bowl.

**Application**

- Used in compressed air systems to automatically expel liquids from piping systems, installed at low points in piping and at end of pipe network where water is likely to accumulate

**Features**

- Metal bowl
- Drain is ported to 1/8" NPT

**Specifications**

- Inlet pressure: 250 PSIG
- Maximum temperature: 175°F (79°C)



Port Size	Part #
1/2"	17-016-107

#### Filter Elements

Used On	Description	Part #
F07	5 micron	3652-11
F08	5 micron	3161-16
	40 micron	3161-18
F17	5 micron bronze	5311-01
	25 micron bronze	5311-02
	40 micron bronze	5311-03
F18	5 micron bronze	5882-11
	25 micron bronze	5882-12
	50 micron bronze	5882-13
F72	5 micron	5925-03
	40 micron	5925-02
F73	5 micron	4438-01
	40 micron	4438-03
F74	5 micron	4338-04
	40 micron	4338-05



5 micron element  
5925-03

#### Filter Bowl / Bowl Guards

Used On	Description	Part #
F07	polycarbonate bowl with auto drain	3646-51
	polycarbonate bowl with manual drain	3646-53
F08	transparent bowl with manual drain	3776-50
F17	metal bowl with petcock drain	5390-77
F72	transparent bowl with manual drain	4266-50RF
	transparent bowl with semi-automatic drain	4266-52RF
F73	transparent bowl with manual drain, 1/4 turn	4425-50RF
	transparent bowl with auto drain	4425-51RF
F74	plastic bowl assembly with guard and 1/4 turn manual drain	4325-51R
	plastic bowl assembly with guard and automatic drain	4325-52R



transparent bowl and guard  
4325-51R

Series 1 FRLs Accessories

Filter Drains



Used On	Description	Part #
F17, F74	auto drain	3000-10
	manual drain	619-50
	manual drain assembly	2796-52
F72, F73	auto drain	4000-51R
F72, F73 F74	manual drain	619-50

Filter Lens Kits



Used On	Description	Part #
F72	liquid level lens kit	4380-020
F73	liquid level lens kit	4380-030
F74	high pressure dome sight glass kit	4380-051

Filter Indicator Conversion Kit

Features

- Allows addition of service life indicator in the field
- For general purpose and oil removal filters



Used On	Description	Part #
F72, F73, F74	service life indicator	5797-50

Filter Service Kit

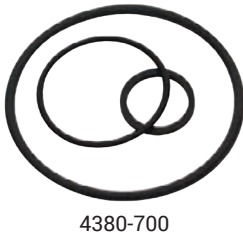

Used On	Description	Part #
F17	O-rings, seals, and gaskets	5578-05
F18		5945-50
F73		4380-600
F74		4380-700

Filter Oil / Vapor Removal Filters



Used On	Description	Part #
F74C	oil removal filter	4344-01
F74H	oil removal filter	4344-02
F74V	vapor removal filter	4341-01



## Series 1 FRLs Accessories

### Regulator Springs

Used On	Pressure Ratings	Part #
R74	5-60 PSI	4332-01
	5-150 PSI	4332-02



4432-02

### Tamper-Resistant Covers

#### Features

- Helps prevent unauthorized pressure adjustment setting
- Cover can be locked in place with up to four padlocks
- Installs on adjusting knob

Used On	Description	Part #
R72	tamper-resistant cover with seal wire	4255-51
R73		4455-51
R74		4355-51



F

### Regulator Panel Nuts

Used On	Description	Part #
R07	plastic panel nut	2962-89
R08	plastic panel nut	5191-89
R17	metal panel nut	5226-97
R72	plastic panel nut	4248-89
R73	zinc panel nut	5191-88
R74	zinc panel nut	4348-89



4248-89

### Regulator Diaphragm Relieving Kits

Used On	Description	Part #
R07	diaphragm, relieving	3407-02
R08		5298-14
R11		529-03
R17		5578-02
R72		4381-500
R73		4381-600
R74		4381-700



3407-02



4381-700

**Series 1 FRLs Accessories**

**Lubricator Bowl / Bowl Guards**



3646-54

Used On	Description	Part #
L07	polycarbonate bowl with manual drain	3646-54
L73	transparent bowl with manual drain	4425-50RL
L74	metal bowl with liquid level indicator and 1/4 turn manual drain	4303-77R
	transparent bowl with manual drain	4325-50R

**Seal Wire**

**Feature**

- Provides tamper-resistant protection of the lubricator drip rate setting



seal wire

Used On	Description	Part #
L73, L74	metal wire	2117-01

**Domes, Caps, and Plugs**



18-011-021



5605-50

Used On	Description	Part #
L08	quick-fill cap	18-011-024
L17, L74	quick-fill cap	18-011-021
L73, L74	aluminum fill plug	5301-55
L17, L72, L73, L74	sight feed dome (micro-fogging design)	4055-50
L72, L74	sight feed dome (oil-fogging design)	4055-51
L74	high pressure sight feed dome	5605-50
	liquid level indicator repair kit	4380-050

**Lubricator Seal Kits**



5771-02

Used On	Description	Part #
L17	O-rings, seals, and gaskets	5771-02
L73		4382-600
L74		4382-700

## Series 1 FRLs Quick Clamps and Brackets

**Features**

**Quick-clamp**

- Provides modular installation capability
- Flanges designated to slide into V grooves in clamp
- Face-sealing O-rings provide a positive seal when clamp is closed and screw tightened

**Bracket for quick-clamp**

- Provides secure mounting to a wall, machine panel or other flat surface

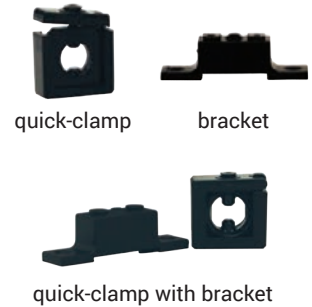

Used On Filter/ Regulator/ Lubricator Series	Description	Part #
L72	quick-clamp	4214-51
F72	quick-clamp service kit (2 O-rings)	4384-570
R72	quick-clamp and bracket assembly	4214-52
F73, F74, R73, R74, L72, L73	quick-clamp	4314-51
	quick-clamp service kit (2 O-rings)	4384-770
	wall bracket for quick-clamp (uses 7/32" screws)	4313-50
	quick-clamp and bracket assembly	4314-52

### Blocks

**Features**

- Installed with quick-clamps
- Provides additional outlets and manifolding capability

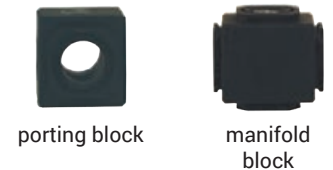

Used On Filter/ Regulator/ Lubricator Series	Description	Part #
F73, F74, R73, R74, L73, L74	porting block, three 1/4" PTF outlets	4316-50
	manifold block, three 3/4" PTF outlets	4328-50

### Pipe Adapters

**Features**

- Installed with quick-clamps
- Provides PTF connections to system piping
- Sold individually



Used On Filter/ Regulator/ Lubricator Series	Description	Part #
L72, F72, R72	1/4" PTF connections	4215-02
	3/8" PTF connections	4215-03
	1/4" PTF connections	4315-01
F73, F74, R73, R74, L73, L74	3/8" PTF connections	4315-02
	1/2" PTF connections	4315-03
	3/4" PTF connections	4315-04

NOTE: Used on filters / regulators / lubricator series

**Series 1 FRLs  
Mounting Brackets**



mounting bracket  
6212-50

Used On	Description	Part #
F07	mounting bracket only	5939-06
L07	mounting bracket only	5095-17
F17, L17	mounting bracket kit for 3/4" and 1" ported units	6212-50

**Wall Mounting Brackets**

**Features**

- Alternate to quick-clamps and pipe adapters
- Used to secure to a wall, machine panel, or other flat surface
- Use close nipples on page 928 to connect combination unit and then place in bracket.



4324-50

Used On Filter/ Regulator/ Lubricator Series	Description	Part #
L72, F72, R72	wall mounting bracket for all F72 series	4224-50
L73, F73, R72	wall mounting bracket for all F73 series	4424-50
L74, F74, R74	wall mounting bracket for all F74 series	4324-50



18-025-003



5203-06

**Regulator Mounting Brackets**

Used On Filter/ Regulator/ Lubricator Series	Description	Part #
B07, R07		18-025-003
B08, R08	mounting bracket with plastic panel nut	5203-06
R17		5570-04

## Watts Filters

### F602-Series Hi-Flow

#### Features

- 40 micron polypropylene element

#### Specifications

- Automatic drain operating conditions:
  - temperature range: 40°F (4°C) to 120°F (49°C)
  - maximum operating: 175 PSIG (12 bar)
- Manual drain operating conditions:
  - temperature range: 40°F (4°C) to 150°F (66°C)
  - maximum operating: 250 PSIG (17 bar)

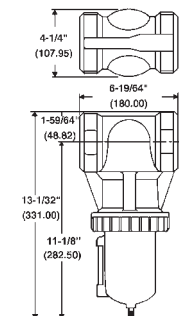
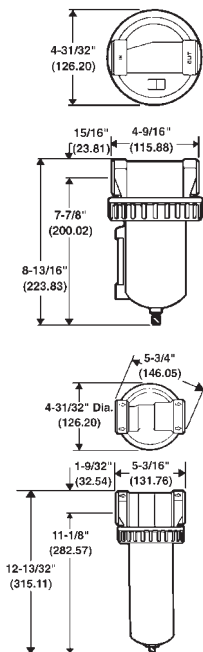

#### Zinc Body with Sight Glass and 16" Bowl

Size	Flow (SCFM)	Automatic Drain Part #	Manual Drain Part #
3/4"	270	F602-06WJR	F602-06WJ
1"	300	F602-08WJR	F602-08WJ
1-1/2"	450	F602-12WJR	F602-12WJ

#### Aluminum Body with 26" Bowl

Size	Flow (SCFM)	Automatic Drain Part #	Manual Drain Part #
2"	1200	F602-16WJR	F602-16WJ

NOTE: See pages 343 - 344 for accessories.  
 SCFM ratings given at 90 PSIG inlet pressure.  
 FRLs are designed for air service only, unless otherwise indicated. Obsolete once stock is depleted.



## Watts Regulators

### R643-Series Miniature

#### Features

- Relieving type
- Diaphragm operated
- Non-rising adjusting knob
- 1/8" gauge port

#### Specifications

- Pressure range 2 - 125 PSIG (.15 - 8.5 bar)
- Inlet pressure: 300 PSIG (20.4 bar) maximum
- Temperature range: **40°F (4°C) to 120°F (49°C)**

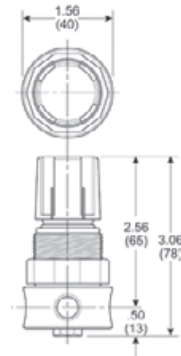

F



R374-02CG

R364-02C

Size	Flow (SCFM)	Body Material	With Gauge Part #	Without Gauge Part #
1/4"	10	brass	R364-02CG	R364-02C
		aluminum	R374-02CG	R374-02C

NOTE: SCFM ratings given at 100 PSIG inlet pressure.

NOTE: See pages 343 - 344 for accessories.

FRLs are designed for air service only, unless otherwise indicated.

SCFM ratings given at 100 PSIG inlet pressure.



## Watts Regulators

### R119-Series Standard

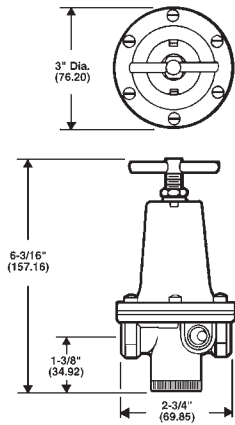

#### Features

- Zinc body
- Relieving type
- Diaphragm operated
- Spring adjustment mechanism
- T-handle design
- Brass bottom plug
- Aluminum spring cage
- Uses a GC230 gauge

#### Specifications

- Pressure range 2 - 125 PSIG (.15 - 8.5 bar)
- Inlet pressure: 300 PSIG (20.4 bar) maximum
- Temperature range: 40°F (4°C) to 120°F (49°C)

Size	Flow (SCFM)	With Gauge Part #	Without Gauge Part #
1/4"	100	R119-02CG	R119-02C
3/8"	110	R119-03CG	R119-03C
1/2"	150	R119-04CG	R119-04C

NOTE: SCFM ratings given at 100 PSIG inlet pressure.



F

### R119-Series High-Flow

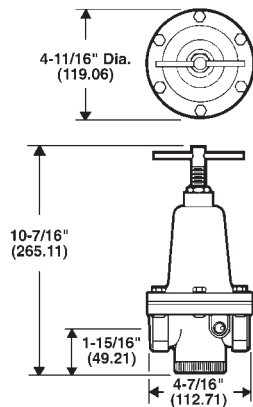

#### Features

- Zinc body
- Relieving type
- Diaphragm operated
- Spring adjustment mechanism
- T-handle design
- Acetal bottom plug
- Aluminum spring cage
- Uses a GC230 gauge

#### Specifications

- Pressure range 2 - 125 PSIG (.15 - 8.5 bar)
- Inlet pressure: 300 PSIG (20.4 bar) maximum
- Temperature range: 40°F (4°C) to 120°F (49°C)

Size	Flow (SCFM)	With Gauge Part #	Without Gauge Part #
3/4"	300	R119-06CG	R119-06C
1"	400	R119-08CG	R119-08C
1-1/2"	500	R119-12CG	R119-12C



NOTE: See pages 343 - 344 for accessories.  
 SCFM ratings given at 100 PSIG inlet pressure.  
 FRLs are designed for air service only, unless otherwise indicated. 

## Watts Lubricators

### L606-Series Standard

#### Features

- 16 oz. bowl
- Zinc body
- 3/4", 1", and 1-1/2" are fillable while under pressure

#### Specifications

- Maximum operating conditions:
  - temperature range: **40°F (4°C) to 150°F (66°C)**
  - maximum operating pressure: 250 PSIG (17 bar)

Size	Flow (SCFM)	Zinc Bowl with Sight Glass Part #
3/4"	325	L606-06W
1"	350	L606-08W
1-1/2"	400	L606-12W



L606-12W

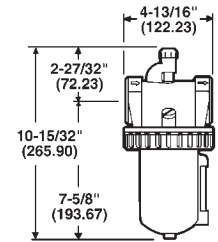
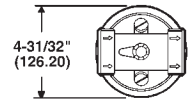
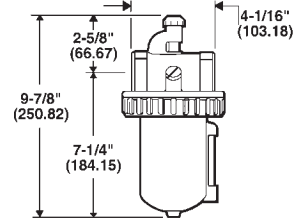
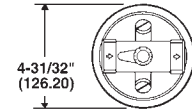

F

NOTE: See pages 343 - 344 for accessories.

See page 267 for air tool lubricant.

FRLs are designed for air service only, unless otherwise indicated.

SCFM ratings given at 90 PSIG inlet pressure.





## Watts Combination Units

### C119-Series Standard

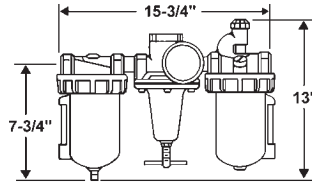

#### Features

- 16 oz. bowl
- 40 micron polypropylene element
- Zinc body

#### Specifications

- Maximum operating conditions:
  - temperature range: 40°F to 150°F (4°C to 66°C)
  - maximum operating pressure: 250 PSIG (17 bar)



### Zinc Bowl with Sight Glass

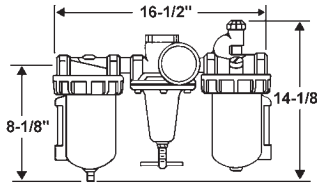

Size	Flow (SCFM)	Automatic Drain Part #	Manual Drain Part #
3/4"	275	C119-06AMB	C119-06MMB
1"	320	C119-08AMB	C119-08MMB
1-1/2"	550	C119-12AMB	C119-12MMB



**F**

NOTE: FRLs are designed for air service only, unless otherwise indicated.  SCFM ratings given at 90 PSIG inlet pressure.

## Watts Kits & Accessories

### Filter Elements

Used On	Description	Part #
F602-06	5 micron	EK602VB
F602-08		
F602-12		
F602-06	40 micron	EK602B
F602-08		
F602-12		
F602-16		

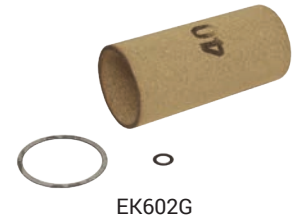

### Filter Drains

Used On	Description	Part #
F602, F602-03, F602-04	auto float drain	PS506



PS506

**Watts Kits & Accessories**

**Regulator Repair Kits**



RK119B

Used On	Description	Part #
R119-02	relieving diaphragm, valve assembly	RK119Y
R119-03		RK119A
R119-04		RK119B
R119-06		RK119D
R119-08		
R119-12		
R364-02		RKR164Y
R374-02		

**Lubricant Repair Kit**



Used On	Description	Part #
L606-06	sight glass	RKB605WB
L606-08		
L606-12		

**Lubricator Mounting Brackets**



SA200AW57

Used On	Description	Part #
L606-02, F602-02, L606-03, F602-03, L606-04, F602-04	mounting bracket	PS743
L606-06, F602-06	mounting bracket (2 required)	SA200AW57
L606-08, F602-08	mounting bracket (2 required)	SA200CW57

**Regulator Mounting Brackets**



SAR10Y57



SA15Y57

Used On	Description	Part #
R11, B11	mounting bracket with panel nut	SAR10Y57
R119-02	mounting bracket	SA15Y57
R119-03		
R119-04	mounting bracket	18A57
R119-06	mounting bracket	18B57
R119-08		
R119-12		
R364-02	mounting bracket with panel nut	SA161X57
R374-02		

## Dixon® Gauges

### Application

- All of the gauges supplied by Dixon are designed for long, reliable service under rugged conditions. Typical applications include those on pumps, hydraulic and pneumatic systems, compressors, machine tools, and many other installations where it is necessary to have a gauge with a non-corrosive movement. The gauges available include standard dry and liquid-filled pressure gauges, compound pressure gauges, vacuum gauges, and welding gauges. Materials available include brass, stainless steel, and plastic

**Figure Interval** - Figure Interval (Increments between PSI numbers on gauge face)

**Gradient Interval** - Graduation Interval (Fractional increments between PSI numbers on gauge face)

### ABS Standard Dry Gauges

#### Features

- ASME B40.1, Grade B ( $\pm 3\text{-}2\text{-}3\%$  accuracy)
- PowerFlex™ movement with polyester segment, designed to resist the effects of shock, vibration and pulsation

#### Materials

- ABS plastic case, corrosion resistant
- Polycarbonate window
- Black aluminum pointer

#### Specifications

- C-shaped bronze safety bourdon tube (600 PSI and lower)
- Helical wound bronze safety bourdon tube (1000 PSI and higher)
- Ambient temperature range:  $-40^{\circ}\text{F}$  to  $150^{\circ}\text{F}$  ( $-40^{\circ}\text{C}$  to  $66^{\circ}\text{C}$ )

### Center Back Mounts

PSI Range	Figure Interval	Minor Gradient	1-1/2" Face 1/8" Center Back Mount Part #	2" Face 1/4" Center Back Mount Part #
0-15	1	.5	---	GC200
0-30	5	.5	GC605	GC215
0-60	5	1	GC610	GC220
0-100	10	2	GC615	GC225
0-160	20	5	GC620	GC230
0-200	20	5	GC625	GC235
0-300	30	5	---	GC240



GC230

### Lower Mounts

PSI Range	Figure Interval	Minor Gradient	2" face, 1/4" lower mount Part #	2-1/2" face 1/4" lower mount Part #	3-1/2" face 1/4" lower mount Part #
0-15	1	.5	GL100	GL300	GS15-4
0-30	5	.5	GL115	GL320	GS30-4
0-60	5	1	GL120	GL325	GS60-4
0-100	10	2	GL125	GL330	GS100-4
0-160	20	5	GL130	GL335	GS160-4
0-200	20	5	GL135	GL340	GS200-4
0-300	30	5	GL140	GL345	GS300-4
0-400	50	10	---	GL347	GS400-4
0-600	50	10	---	GL350	GS600-4
0-1000	200	20	---	GL355	GS1000-4
0-1500	300	50	---	GL360	---
0-2000	400	50	---	GL365	---
0-3000	500	100	---	GL370	---
0-5000	1000	100	---	GL375	---



GL140



## Stainless Steel Dry Gauges

### Application

- Designed for severe service applications, providing the corrosion resistance and durability of a permanently sealed gauge

### Feature

- ± 2-1-2% accuracy

### Materials

- 304 stainless steel case and crimp ring
- Polycarbonate window
- 1/4" NPT lower mount stainless connector
- 316 stainless bourdon tube and socket

### Specification

- Ambient temperature range: -40°F to 140°F (-40°C to 60°C)



GSS100

PSI Range	Figure Interval	Minor Gradient	2-1/2" Face 1/4" Lower Mount Part #
0-15	3	.2	GSS15
0-30	5	.5	GSS30
0-60	10	1	GSS60
0-100	20	2	GSS100
0-160	20	2	GSS160
0-200	50	5	GSS200
0-300	50	5	GSS300
0-400	100	10	GSS400
0-600	100	10	GSS600
0-1000	200	20	GSS1000
0-1500	300	20	GSS1500
0-2000	500	50	GSS2000
0-3000	500	50	GSS3000
0-5000	1000	100	GSS5000
0-10000	2000	200	GSS10000

### Feature

- 1.6% accuracy, exceeds ASME B.40.100 Grade B

### Materials

- 304 series stainless case
- Polycarbonate window, 3-1/2" across
- 1/4" NPT lower mount stainless connector
- 316L stainless bourdon tube and socket, polyester segment

### Specification

- Temperature range: -40°F to 140°F (-40°C to 60°C)



GSS160-4

PSI Range	Figure Interval	Minor Gradient	4" Face 1/4" Lower Mount Part #
0-15	3	.5	GSS15-4
0-30	5	.5	GSS30-4
0-60	10	1	GSS60-4
0-100	20	2	GSS100-4
0-160	20	2	GSS160-4
0-200	40	5	GSS200-4
0-300	50	5	GSS300-4
0-400	50	10	GSS400-4
0-600	100	10	GSS600-4
0-1000	200	10	GSS1000-4
0-1500	200	20	GSS1500-4
0-3000	500	50	GSS3000-4
0-5000	1000	100	GSS5000-4
0-10000	2000	200	GSS10000-4

## Brass Standard Dry Gauges

### Features

- ASME B40.100 Grade B ( $\pm 3/2/3\%$  accuracy)
- Dual PSI / kPa scale dial

### Materials

- Polished brass case and ring
- Copper alloy bourdon tube

### Specification

- Temperature range  $-40^{\circ}\text{F}$  to  $140^{\circ}\text{F}$  ( $-40^{\circ}\text{C}$  to  $60^{\circ}\text{C}$ )

PSI Range	Figure Interval	Minor Gradient	2-1/2" Face 1/4" Lower Mount Part #
0-15	3	.2	GBR15
0-30	5	.5	GBR30
0-60	10	1	GBR60
0-100	20	2	GBR100
0-160	20	2	GBR160
0-200	50	5	GBR200
0-300	50	5	GBR300
0-400	100	10	GBR400
0-600	100	10	GBR600
0-1000	200	20	GBR1000
0-1500	300	20	GBR1500
0-2000	500	50	GBR2000
0-3000	500	50	GBR3000
0-5000	1000	100	GBR5000



F

## Process Gauges

### Application

- Specifically designed for process, chemical, and petroleum industries, process gauges are engineered to deliver years of accurate service while withstanding vibration, corrosive media, and corrosive atmosphere

### Features

- Accuracy:  $\pm 0.5\%$  ANSI/ASME Grade 2A
- Scale: single scale **PSI** only

### Materials

- Case: black impact resistant thermoplastic, with safety blowout back, solid front, integral back flange (dry)
- Ring: ethylene propylene
- Wetted parts: 316L stainless steel
- Window: polycarbonate
- Dial: white aluminum
- Pointer: black aluminum

### Specification

- Temperature range: dry  $-40^{\circ}\text{F}$  to  $200^{\circ}\text{F}$  ( $-40^{\circ}\text{C}$  to  $93^{\circ}\text{C}$ )

PSI Range	Figure Interval	Minor Gradient	4-1/2" Face 1/2" Lower Mount Part #
0-30	5	.2	PGS30
0-60	10	.5	PGS60
0-100	10	1	PGS100
0-160	20	1	PGS160
0-200	20	2	PGS200
0-300	50	2	PGS300
0-600	10	5	PGS600
0-1000	100	10	PGS1000



## FlutterGuard™ Dry Gauges

### Features

- FlutterGuard™ virtually eliminates pointer flutter, making the gauge easier to read and reducing excessive movement wear, liquid-free casing results in lighter weight and eliminates the chance of gauge leakage
- ASME B40.1, Grade B ( $\pm$  3-2-3% accuracy)
- PowerFlex™ movement with polyester segment, designed to resist the effects of shock, vibration, and pulsation

### Materials

- Polycarbonate window
- Black aluminum pointer
- ABS plastic case, corrosion resistant

### Specifications

- Ambient temperature range of -40°F to 150°F (-40°C to 66°C)
- C-shaped bronze safety bourdon tube (600 PSI gauges and lower)
- Helical wound bronze safety bourdon tube (1,000 PSI gauges and higher)



PSI Range	Figure Interval	Minor Gradient	2-1/2" Face 1/4" Lower Mount Part #
0-15	1	.5	GL300FG
0-30	5	.5	GL320FG
0-60	5	1	GL325FG
0-100	10	2	GL330FG
0-160	20	5	GL335FG
0-200	20	5	GL340FG
0-300	30	5	GL345FG
0-400	50	10	GL347FG
0-600	50	10	GL350FG
0-1000	200	20	GL355FG
0-1500	300	50	GL360FG
0-2000	400	50	GL365FG
0-3000	500	100	GL370FG
0-5000	1000	100	GL375FG

F

## Stainless Panel Builder Gauges

### Applications

- Fits industry standard 2.56" panel hole cutout
- Suitable for corrosive environments
- Used in gaseous and liquid media

### Feature

- ASME B40.100 Grade A  $\pm$  2-1-2% full scale accuracy

### Materials

- 316L stainless steel wetted parts
- 304 stainless steel case and ring
- White aluminum with black lettering; stop pin
- Black aluminum pointer
- Glycerin filled case
- Laminated safety glass window lens

### Specifications

- Ambient temperature range: -4°F to 140°F (-20°C to 60°C)
- Maximum media temperature 212°F maximum

PSI Range	Figure Interval	Minor Gradient	2-1/2" Face 1/4" Lower Back Mount Part #
0-15	3	.2	PBLSS15
0-30	5	.5	PBLSS30
0-60	10	1	PBLSS60
0-100	20	2	PBLSS100
0-160	20	2	PBLSS160
0-200	50	5	PBLSS200
0-300	50	5	PBLSS300
0-400	100	10	PBLSS400
0-600	100	10	PBLSS600
0-800	200	20	PBLSS800
0-1000	200	20	PBLSS1000
0-1500	300	20	PBLSS1500
0-2000	500	50	PBLSS2000
0-3000	500	50	PBLSS3000
0-5000	1000	100	PBLSS5000



F

## Contractor Pressure Gauges

### Feature

- Accuracy class:  $\pm$  1% of span

### Materials

- Wetted parts: copper alloy
- Window: acrylic, snap in
- Dial: aluminum, white
- Pointer: aluminum, black, adjustable
- Mounting flanged/bracket; rear flange: stainless steel
- Case: stainless steel

PSI Range	4-1/2" face, 1/4" Lower Mount Part #
0-15	4277750-0001
0-30	4277768-0001
0-60	4277776-0003



### Compound Gauges

**Feature**

- ASME B40.1, Grade B accuracy ( $\pm 3-2-3$  % accuracy)

**Materials**

- ABS plastic case, corrosion resistant
- Bronze bourdon tube / brass socket
- Polycarbonate window
- Black aluminum pointer
- Powerflex movement with polyester segment, designed for extended wear

**Specification**

- Temperature range of  $-40^{\circ}\text{F}$  to  $150^{\circ}\text{F}$  ( $-40^{\circ}\text{C}$  to  $66^{\circ}\text{C}$ )



F

Mercury (Hg)	PSI Range	Figure Interval (Hg / PSI)	Minor Gradient (Hg / PSI)	2-1/2" Face 1/4" Center Back Mount Part #	2-1/2" Face 1/4" Lower Mount Part #
30"	0-100	30 / 10	5 / 2	---	GL310
	0-160	30 / 20	5 / 5	GC210	---
	0-160	30 / 20	10 / 10	---	GL110
	0-200	30 / 20	10 / 10	---	GL315

### Vacuum Gauges

**Features**

- ASME B40.1, Grade B accuracy ( $\pm 3-2-3$  % accuracy)

**Materials**

- ABS plastic case
- Bronze bourdon tube
- Polycarbonate crystal
- Black aluminum pointer
- Powerflex movement with polyester segment, designed for extended wear

**Specification**

- Temperature range:  $-40^{\circ}\text{F}$  to  $150^{\circ}\text{F}$  ( $-40^{\circ}\text{C}$  to  $66^{\circ}\text{C}$ )



Mercury (Hg)	Figure Interval (Hg / PSI)	Minor Gradient (Hg / PSI)	2" Face 1/4" Lower Mount Part #	2" Face 1/4" Center Back Mount Part #	2-1/2" Face 1/4" Lower Mount Part #
30"	5"	.5"	GL105	GC205	GL305



### ABS Case Liquid Filled Gauges

**Feature**

- ASME B40.100, Grade B ( $\pm$  3-2-3% accuracy)

PSI Range	Figure Interval	Minor Gradient	2-1/2" Face 1/4" Lower Mount Part #
0-15	3	.2	GLP500
0-30	5	.5	GLP505
0-60	10	1	GLP510
0-100	20	2	GLP515
0-160	20	2	GLP517
0-200	50	5	GLP520
0-300	50	5	GLP525
0-400	100	10	GLP527
0-600	100	10	GLP530
0-1000	200	20	GLP535
0-1500	300	20	GLP540
0-2000	500	50	GLP545
0-3000	500	50	GLP550
0-5000	1000	100	GLP555



**F**

### Stainless Case Liquid Filled Gauges

**Features**

- PowerFlex™ movement with polyester segment designed to resist the effects of shock, vibration, and pulsation
- ASME B40.100, Grade A ( $\pm$  2-1-2% accuracy)
- 1/4" NPT brass connection

**Materials**

- Copper alloy bourdon tube
- White aluminum dial with black numbers and black aluminum pointer
- Glycerin filled
- Polycarbonate window

**Specification**

- Temperature range: -4°F to 150°F (-20°C to 65°C)

PSI Range	Figure Interval	Minor Gradient	2-1/2" Face 1/4" Center Back Mount Part #	2-1/2" Face, 1/8" Lower Mount Part #
0-15	3	.5	GLSC400	GLS400
0-30	5	.5	GLSC405	GLS405
0-60	10	1	GLSC410	GLS410
0-100	20	2	GLSC415	GLS415
0-160	20	2	GLSC417	GLS417
0-200	40	5	GLSC420	GLS420
0-300	50	5	GLSC425	GLS425
0-400	50	5	GLSC427	GLS427
0-600	100	10	GLSC430	GLS430
0-1000	200	10	GLSC435	GLS435
0-1500	300	50	GLSC440	GLS440
0-2000	400	20	GLSC445	GLS445
0-3000	500	50	GLSC450	GLS450
0-5000	1000	100	GLSC455	GLS455



GLSC420



GLS430

### Stainless Steel Liquid Filled Gauges

**Application**

- Designed for severe service applications, providing the corrosion resistance and durability of a permanently sealed gauge

**Features**

- ± 2-1-2% accuracy
- 1/4" NPT lower mount stainless connector

**Materials**

- Polycarbonate window
- 304 stainless case and crimp ring
- Glycerin filled

**Specification**

- Ambient temperature range: -4°F to 140°F (-20°C to 60°C)



GLSS1500

PSI Range	Figure Interval	Minor Gradient	2-1/2" Face 1/4" Lower Mount Part #
0-15	3	.2	GLSS15
0-30	5	.5	GLSS30
0-60	10	1	GLSS60
0-100	20	2	GLSS100
0-160	20	2	GLSS160
0-200	50	5	GLSS200
0-300	50	5	GLSS300
0-400	100	10	GLSS400
0-600	100	10	GLSS600
0-1000	200	20	GLSS1000
0-1500	300	20	GLSS1500
0-2000	500	50	GLSS2000
0-3000	500	50	GLSS3000
0-5000	1000	100	GLSS5000
0-10000	2000	200	GLSS10000

### All Stainless Steel Liquid Filled Gauges

**Application**

- Designed for severe service applications, providing the corrosion resistance and durability of a permanently sealed gauge

**Features**

- ± 2-1-2% accuracy
- 1/4" NPT center back mount stainless connector

**Materials**

- Polycarbonate window
- 304 stainless case and crimp ring
- Glycerin filled

**Specification**

- Ambient temperature range: -4°F to 140°F (-20°C to 60°C)



PSI Range	Figure Interval	Minor Gradient	2-1/2" Face 1/4" Center Back Mount Part #
0-100	20	2	GLSSC100
0-160	20	2	GLSSC160
0-200	50	5	GLSSC200

## Brass Liquid Filled Gauges

### Features

- ± 2-1-2% accuracy on 2-1/2"; ±1% accuracy on 4"
- Brass movement with highly polished bearing surfaces

### Materials

- Acrylic window with membrane assembly
- Copper alloy bourdon tube
- Glycerin filled
- 2-1/2" face gauges: solid cast brass case with polished ABS cover ring
- 4" face gauges: cast brass, silver painted case with chrome plated brass cover ring

### Specification

- Ambient temperature range: -4°F to 140°F (-20°C to 60°C)

PSI Range	Figure Interval	Minor Gradient	2-1/2" Face 1/4" Lower Mount Part #	2-1/2" Face 1/4" Center Back Mount Part #	4" Face 1/2" Lower Mount Part #
0-15	3	.2	GLBR15	GLBRC15	GLBR15-4
0-30	5	.5	GLBR30	GLBRC30	GLBR30-4
0-60	10	1	GLBR60	GLBRC60	GLBR60-4
0-100	10	1	GLBR100	GLBRC100	GLBR100-4
0-160	20	2	GLBR160	GLBRC160	GLBR160-4
0-200	20	2	GLBR200	GLBRC200	GLBR200-4
0-300	50	5	GLBR300	GLBRC300	GLBR300-4
0-400	50	5	GLBR400	GLBRC400	GLBR400-4
0-600	100	10	GLBR600	GLBRC600	GLBR600-4
0-1000	100	10	GLBR1000	GLBRC1000	GLBR1000-4
0-1500	300	20	GLBR1500	GLBRC1500	GLBR1500-4
0-2000	200	20	GLBR2000	GLBRC2000	GLBR2000-4
0-3000	500	50	GLBR3000	GLBRC3000	GLBR3000-4
0-5000	500	50	GLBR5000	GLBRC5000	GLBR5000-4
0-10000	1000	100	---	---	GLBR100004



F

## Welding Gauges

### Features

- ± 3-2-3% accuracy according to ASME B40.100 Grade B
- "USE NO OIL" written in red on face

### Materials

- Polished drawn stainless steel case
- Twist-lock polycarbonate window
- Copper alloy bourdon tube

### Specification

- Ambient temperature range: -40°F to 140°F (-20°C to 60°C)

PSI Range	Figure Interval	Minor Gradient	2-1/2" Face 1/4" Lower Mount Part #
0-30	5	.5	GBRW30
0-30	5	.5	GBRW30R <sup>1</sup>
0-60	10	1	GBRW60
0-100	20	2	GBRW100
0-200	50	5	GBRW200
0-400	100	10	GBRW400
0-600	100	10	GBRW600
0-4000	500	100	GBRW4000



<sup>1</sup> Red band between 15 to 30 PSI on GBRW30R

## General Purpose Digital Gauges

### Applications

- General purpose digital gauges are suitable for dry air applications and other media; gauge offers selectable units of measure so rather than purchasing one gauge for each unit of measure required; one gauge can be used for multiple units of measure
- Ideal for test applications and for use in technicians' tool kits

### Features

- 0.5% terminal point accuracy
- Five-digit LCD display with large size .48" characters
- Bar graph display (20 segment)
- Nine engineering units (accessed through keypad): PSI, in. HG, cm Hg, mm Hg, KPA, Mpa, BAR, KG/cm2, ft H2O
- IP67 weatherproof enclosure, polycarbonate / ABS
- Two AA alkaline batteries included
- 2,000 hour minimum battery life

### Material

- Wetted parts: 17-4 PH stainless steel sensor with 316L stainless steel socket

### Specifications

- Operating temperature: -4°F to 140°F (-20°C to 60°C)
- Polycarbonate window
- Other pressure and compound ranges available



PSI Range	2-1/2" Face 1/4" Lower Mount Part #
0-100	DG100
0-300	DG300
0-1000	DG1000
0-10,000	DG10000

## 180° Steam Gauge Siphons

### Application

- In steam service, the siphon will prevent hot steam from entering a pressure gauge, diaphragm seal or transmitter; recommended for applications involving temperatures above 100°F (37°C); also use siphons whenever condensing hot vapors (not just steam) are present

### Features

- Red brass pipe
- Complies with ASTM B-43



### Specification

- Pressure rating: 200 PSI at 406°F (208°C)



Male IPS	Red Brass Part #
1/4"	401-01

### Features

- Steel pipe
- 1/4" NPT schedule 40 steel, welded

### Specification

- Pressure rating: 175 PSI at 340°F (171°C)



Male IPS	Steel Part #
1/4"	401-01S

## Bi-Metal Thermometers

### Features

- Case: sturdy, corrosion-resistant series 304 stainless steel
- Bezel crystal: optically clear, strong glass, gasketed to maintain weather-tight integrity is standard
- Stem: 304 series stainless steel, welded at tip and case connector to prevent leakage, 1/4" (6.35 mm) diameter
- ASME B40.200 compliant
- Slotted-hex adjustment head offers screwdriver or wrench use to field calibrate the thermometer
- Bi-metal element: an extremely responsive temperature sensing helix which has been carefully sized and tested, heat treated and aged to relieve inherent stresses and insure continued accuracy
- Dampening: bi-metal helix is coated with a viscous silicone to minimize pointer oscillation and to improve temperature transmission
- Immersion: for accurate temperature readings, immerse stem a minimum of 2" (50 mm) in agitated liquids or 4" (100 mm) in moving air or gas
- Over range: temporary over or under range of 50% of scale up to **260°C** or **500°F** will not affect the instrument accuracy
- Accuracy: guaranteed to be accurate to within 1% of full scale
- Standard connection is 1/2" male NPT



### Model 30 Back Connected

Stem Length	Temperature Range	3" Face Part #
2-1/2"	0-250°F/-20-120°C	30025064
	50-500°F/10-260°C	30025104
4"	0-250°F/-20-120°C	30040064
	50-500°F/10-260°C	30040104
6"	0-250°F/-20-120°C	30060064
	50-500°F/10-260°C	30060104
9"	0-250°F/-20-120°C	30090064
	50-500°F/10-260°C	30090104



### Model 31 Bottom Connected 90° Angle

Stem Length	Temperature Range	3" Face Part #
2-1/2"	0-250°F/-20-120°C	31025064
4"	50-500°F/10-260°C	31040104



### Model 50 Back Connected

Stem Length	Temperature Range	5" Face Part #
2-1/2"	50-500°F/10-260°C	50025104
4"	0-250°F/-20-120°C	50040064



### Model 52 Adjustable Angle

Stem Length	Temperature Range	5" Face Part #
2-1/2"	0-250°F/-20-120°C	52025064
4"	0-250°F/-20-120°C	52040064
4"	50-500°F/10-260°C	52040104



### Bi-Metal Pocket Thermometers

**Features**

- External reset with hex nut on back of case
- Bi-metal element: responsive actuation by bi-metal helix
- Dampening: bi-metal helix is coated with a viscous silicone to minimize pointer oscillation
- Scale length: approximately 2-1/8" (54mm)
- Accuracy: 1%



**Materials**

- Case: 304 stainless steel hermetically sealed
- Crystal: extra heavy polycarbonate
- Stem: 304 series stainless steel
- Polyethylene carrying case with clip

Temperature Range	Part #
0°F to 220°F (-18°C to 104°C)	PT220
50°F to 550°F (10°C to 288°C)	PT550

### Magnetic Surface Mount Thermometers

**Features**

- Case: steel, 2" x 1/2"
- Dial: polished aluminum
- Bi-metal element: responsive actuation by bi-metal helix
- Accuracy: ± 2%



Temperature Range	2" Face Part #
0°F to 250°F (-18°C to 121°C)	MT250
0°F to 500°F (-18°C to 260°C)	MT500

### Threaded Thermowells

**Feature**

- 3/4" male NPT process connection

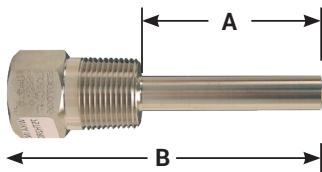

'A' dimension	'B' dimension	316 Stainless Steel Part #
1-5/8"	2-1/2"	75TH2R015SS
2-1/2"	4"	75TH2R025SS
4-1/2"	6"	75TH2R045SS
7-1/2"	9"	75TH2R075SS

F

<b>King Combination Nipples.....</b>	<b>358 - 363</b>	<b>Polyethylene Crimp Bauer Style .....</b>	<b>387 - 388</b>
NPT threaded .....	358	Type A .....	387
Beveled end .....	359	Type B .....	388
Grooved end .....	359		
BSPT end .....	359	<b>Strainers, Skimmers &amp; Foot Valves..</b>	<b>389 - 391</b>
Jump size NPT threaded .....	360	Strainers .....	389
Global NPT threaded.....	360	Skimmers.....	390
For plastic pipe NPT threaded.....	361	Flexible strainers.....	390
150# ASA flange .....	361	Foot valves .....	391
Turned back.....	361		
Notched turned back .....	362		
Notched ferrules.....	362		
PF shank.....	363		
External swage notched .....	363		
Notched NOS ferrules .....	363		
<b>Short Crimp Sleeves .....</b>	<b>364</b>		
<b>King Nipples.....</b>	<b>365</b>		
Steel round .....	365		
Steel hex .....	365		
<b>Plastic Barbs and Inserts .....</b>	<b>366</b>		
Hose shank x male NPT.....	366		
Tuff-Lite® .....	366		
<b>Hose Menders .....</b>	<b>367 - 369</b>		
Dixon® menders.....	367		
King menders .....	368		
Barbed menders .....	368		
Short shank menders.....	368		
Tuff-Lite menders .....	369		
<b>Shank Couplings .....</b>	<b>370 - 377</b>		
Suction couplings .....	370 - 371		
Short shank .....	370, 371, 373		
Long shank.....	372, 374, 375		
Spanner wrenches .....	372		
Spray hose.....	376		
Gaskets.....	377		
<b>Agri-Lock Style Couplings .....</b>	<b>378 - 381</b>		
Type A .....	378 - 381		
<b>Bauer Style Couplings .....</b>	<b>382 - 386</b>		
Type B .....	382 - 386		

### King Combination Nipples



**Applications**

- Recommended for low-pressure discharge and suction service for compatible liquids, sizes 1-1/4" and above are not for compressible products such as air or nitrogen
- King combination nipples are not recommended for steam
- The working pressure may vary with the construction of the hose, the type of clamping system used, and the application, consult Dixon® for recommendations
- In accordance with the Association for Rubber Products Manufacturers (ARPM) bulletin for oil suction and discharge hose, a coupled length of hose in any size, should be tested to 1-1/2 times the working pressure and held for fifteen minutes without leaking or coupling movement, for additional information and detailed instruction on testing procedures, see the Association for Rubber Products Manufacturers (ARPM) handbook

### NPT Threaded End with Knurled Wrench Grip



Size	Opt Qty	Unplated Steel Part #	Plated Steel Part #	Brass Part #	Aluminum Part #
1/2"	50	ST1	STC1	BST1	AST1
3/4"	50	ST5	STC5	BST5	AST5
1"	50	ST10	STC10	BST10	AST10
1-1/4"	50	ST15	STC15	---	---
1-1/2"	50	ST20	STC20	---	---
2"	25	ST25	STC25	---	---

NOTE: For additional information on pipe dimensions please reference [dixonvalve.com](http://dixonvalve.com).

### NPT Threaded End No Knurl



Size	Opt Qty	Unplated Steel Part #	Plated Steel Part #	Brass Part #	Aluminum Part #
1-1/4"	50	---	---	BST15	AST15
1-1/2"	50	---	---	BST20	AST20
2"	25	---	---	BST25	AST25
2-1/2"	10	ST30	STC30	BST30	AST30
3"	10	ST35	STC35	BST35	AST35
4"	4	ST40	STC40	BST40	AST40
5"	4	ST50	STC50	---	AST50
6"	2	ST60	STC60	---	AST60
8"	2	ST80	STC80	---	---
10"	1	ST100	STC100	---	---
12"	1	ST120	STC120	---	---



Size	Opt Qty	316 Stainless Steel Part #	Hastelloy® Part #
1/2"	50	RST1 <sup>1</sup>	---
3/4"	50	RST5 <sup>1</sup>	---
1"	50	RST10	---
1-1/4"	50	RST15	---
1-1/2"	50	RST20	---
2"	25	RST25	HST25
2-1/2"	10	RST30	---
3"	10	RST35	HST35
4"	4	RST40	---
5"	4	RST50	---
6"	4	RST60	---
8"	2	RST80	---

<sup>1</sup> Made from investment casting

NOTE: For additional information on pipe dimensions please reference [dixonvalve.com](http://dixonvalve.com). King Crimp® fittings, ferrules, and sleeves can be found on pages 5 - 17.



## King Combination Nipples

### Beveled End

#### Feature

- Beveled ends (in brass) are available in select sizes. Consult Dixon® for prices and availability

Hose I.D.	Unplated Steel Part #	Opt Qty	316 Stainless Steel Part #	Opt Qty	Aluminum Part #
1/2"	STB1	50	---	--	---
3/4"	STB5	50	RSTB5	50	---
1"	STB10	50	RSTB10	50	ASTB10
1-1/4"	STB15	50	RSTB15	50	ASTB15
1-1/2"	STB20	50	RSTB20	50	ASTB20
2"	STB25	25	RSTB25	25	ASTB25
2-1/2"	STB30	10	RSTB30	10	ASTB30
3"	STB35	10	RSTB35	10	ASTB35
4"	STB40	4	RSTB40	4	ASTB40
5"	STB50	4	---	--	ASTB50
6"	STB60	2	RSTB60	4	ASTB60
8"	STB80	2	RSTB80	2	ASTB80
10"	STB100	1	---	--	ASTB100
12"	STB120	1	---	--	---

NOTE: For additional information on pipe dimensions please reference [dixonvalve.com](http://dixonvalve.com).



G

## King Combination Nipples

### Grooved End

#### Features

- Grooved ends (in brass and aluminum) are available in select sizes. Consult Dixon for prices and availability
- See pages 962, 965 for our complete line of groove style fittings

Hose I.D.	Unplated Steel Part #	Opt Qty	316 Stainless Steel Part #	Opt Qty
1"	STV10	50	---	---
1-1/4"	STV15	50	---	---
1-1/2"	STV20	50	RSTV20	50
2"	STV25	25	RSTV25	25
2-1/2"	STV30	10	---	---
3"	STV35	10	RSTV35	10
4"	STV40	4	RSTV40	5
5"	STV50	4	---	---
6"	STV60	4	---	---
8"	STV80	2	---	---
10"	STV100	1	---	---
12"	STV120	1	---	---

NOTE: For additional information on pipe dimensions please reference [dixonvalve.com](http://dixonvalve.com).



## King Combination Nipples

### BSPT End

Size	Plated Steel Part #	Opt Qty	316 Stainless Steel Part #	Opt Qty
1"	STC10A	50	RST10A	50
1-1/4"	STC15A	50	RST15A	50
1-1/2"	STC20A	50	RST20A	50
2"	STC25A	50	RST25A	25
2-1/2"	STC30A	10	RST30A	10
3"	STC35A	10	RST35A	10
4"	STC40A	4	RST40A	4
6"	STC60A	2	RST60A	2

NOTE: King Crimp® fittings, ferrules, and sleeves can be found on pages 5 - 17.



### Jump Size King Combination Nipples

NPT Threaded End



reducer



increaser

Hose Shank	Male NPT	Plated Steel Part #	316 Stainless Steel Part #
3/4"	1/2"	---	RST0501
	1"	STC0510	RST0510
1"	3/4"	STC1005	RST1005
	1 1/4"	STC1015	RST1015
1-1/4"	1"	STC1510	RST1510
	1-1/2"	STC1520	RST1520
1-1/2"	1-1/4"	STC2015	RST2015
	2"	STC2025	RST2025
1-3/4"	2"	STC175200	---
	1-1/2"	STC2520	RST2520
2"	2-1/2"	STC2530	---
	3"	STC2535	RST2535
	2"	STC3025	RST3025
2-1/2"	3"	STC3035	---
	2"	STC3525	RST3525
3"	2-1/2"	STC3530	---
	4"	STC3540	---
	3"	STC4035	---

NOTE: For additional information on pipe dimensions please reference dixonvalve.com.

### Global King Combination Nipples

NPT Threaded End



**Features**

- Combination nipples are recommended for low-pressure discharge and suction service for compatible liquids, sizes 1-1/4" and above are not for compressible products such as air or nitrogen
- Global King combination nipples are not recommended for steam.
- The working pressure may vary with the construction of the hose, the type of clamping system used, and the application. Consult Dixon® for recommendations.
- In accordance with the Association for Rubber Products Manufacturers (ARPM) bulletin for oil suction and discharge hose, a coupled length of hose in any size, should be tested to 1-1/2 times the working pressure and held for fifteen minutes without leaking or coupling movement, for additional information and detailed instruction on testing procedures, see the Association for Rubber Products Manufacturers (ARPM) handbook



Size	Plated Steel Part #	Opt Qty
1/2"	GSTC1	100
3/4"	GSTC5	100
1"	GSTC10	50
1-1/4"	GSTC15	50
1-1/2"	GSTC20	50
2"	GSTC25	25
2-1/2"	GSTC30	10
3"	GSTC35	10
4"	GSTC40	4
5"	GSTC50	4
6"	GSTC60	4

NOTE: King Crimp® fittings, ferrules, and sleeves can be found on pages 5 - 17.

G

### King Combination Nipples for Plastic Pipe

#### NPT Threaded End

Size	Plated Steel Part #	Optional Qty
1/2"	SAP1	50
3/4"	SAP6	50
1"	SAP11	50
1-1/4"	SAP16	50
1-1/2"	SAP21	50
2"	SAP26	25

NOTE: For additional information on pipe dimensions please reference [dixonvalve.com](http://dixonvalve.com).



### Flanged King Combination Nipples

#### 150# ASA

Size	Steel Part #	316 Stainless Steel Part #
1-1/2"	FST20	RFST20
2"	FST25	RFST25
3"	FST35	RFST35
4"	FST40	RFST40
6"	FST60	RFST60
8"	FST80	RFST80
10"	FST100	RFST100
12"	FST120	RFST120

NOTE: For flange dimensions, diagrams, and additional information please reference [dixonvalve.com](http://dixonvalve.com).



G

### King Turned Back Hose Nipples for Floating Flanges

#### Features

- A turned back nipple, when used in a floating flange assembly, allows the flange to be aligned without stressing (twisting) the hose, this generally increases the hose's service life by eliminating a common cause of premature hose failure
- For use with lap joint flanges shown on page 956

Size	Plated Carbon Steel Part #	316 Stainless Steel Part #
1"	N10	RN10
1-1/4"	N15	RN15
1-1/2"	N20	RN20
2"	N25	RN25
2-1/2"	N30	RN30
3"	N35	RN35
4"	N40	RN40
6"	N60	RN60
8"	N80	RN80
10"	N100	RN100
12"	N120	RN120

NOTE: For additional information on pipe dimensions please reference [dixonvalve.com](http://dixonvalve.com).  
King Crimp® fittings, ferrules, and sleeves can be found on pages 5 - 17.



## Notched Turned Back Nipples

### Features

- When used with an appropriate notched ferrule, these fittings can be swaged or crimped onto hose providing improved shank retention
- When used with double bolt or band clamps, notched turn back nipples provide shank retention similar to that of the King® turned back nipples
- The stem can be removed from a damaged hose by cutting away the ferrule without necessarily damaging the fitting
- For use with lap joint flanges on page 956



Special pushers required:  
 1-1/2" stem - RN150NOPUSH  
 2" stem - RN200NOPUSH  
 2-1/2" stem - RN250NOPUSH  
 3" stem - RN300NOPUSH  
 4" stem - RN400NOPUSH

Size	Carbon Steel Part #	316 Stainless Steel Part #
1-1/2"	N150NO	RN150NO
2"	N200NO	RN200NO
2-1/2"	N250NO	RN250NO
3"	N300NO	RN300NO
4"	N400NO	RN400NO

NOTE: For additional information on pipe dimensions please reference dixonvalve.com.

## Notched Ferrules

### Features

- Reference notched shanks above and adapters on page 47
- Dixon stems and ferrules are specifically designed to be used together as a coupling system, due to differences in dimensions and tolerances for safety reasons, do not use other manufacturers' stems or ferrules with Holedall® products



Size	Hose O.D.		304 Stainless Steel Part #
	From	To	
1-1/2"	1-60/64"	2-12/64"	GAS2334NO
	2-4/64"	2-22/64"	GAS2370NO
2"	2-30/64"	2-44/64"	GAS2709NO
	2-42/64"	2-54/64"	GAS2885NO
2-1/2"	2-54/64"	3"	GAS3012NO
	3-1/64"	3-13/64"	GAS3260NO
3"	3-30/64"	3-46/64"	GAS3760NO
	3-47/64"	3-54/64"	GAS3885NO
4"	4-40/64"	4-47/64"	GAS5010NO

NOTE: King Crimp® fittings, ferrules, and sleeves can be found on pages 5 - 17.

## PF Shank King Combination Nipples NPT Threaded End

**Application**

- This shank design was developed specifically for chemical transport hoses having crosslinked polyethylene (XLPE) or ultra high molecular weight polyethylene (UHMW) tubes, where shank retention can be a problem when using conventional band clamps

**Features**

- PF shank King combination nipples have the same shank pattern as found on the PF style cam and groove fittings sold on page 43
- Recommended for discharge and suction service
- Not intended for compressed air

**Specifications**

- Working pressure is given at 70°F (21°C) maximum
- The working pressure may vary with the construction of the hose, the type of clamping system used, and the application, consult Dixon® for recommendations



Size	Working PSI	Plated Steel Part #	316 Stainless Steel Part #
2"	250	ST25PF	RST25PF
3"	125	ST35PF	RST35PF
4"	100	ST40PF	RST40PF
6"	75	ST60PF	RST60PF

NOTE: Beveled ends for welding are also available. Contact Dixon for further information. For additional information on pipe dimensions, please reference dixonvalve.com.

### External Swage Notched NOS Stems



The notched system allows you to better manage your inventories. You can stock one stem and two ferrules and cover the same hose range with less inventory. You must purchase a fitting and the matching ferrule to create an assembly.

**Features**

- For hose outside diameters of 2-4/64" and below, couplings are crimp only
- For hose outside diameters of 2-5/64" and above, couplings can be crimped or swaged
- See page 36 for cam and groove style notched NOS fittings
- Only use the NOS shank with the NOS ferrules, due to differences in dimensions and tolerances for safety reasons, do not use other manufacturers' stems or ferrules with Dixon Holedall® products



Size	PSI	316 Stainless Steel Part #
1-1/2"	250	RST150NOS
2"	250	RST200NOS
3"	250	RST300NOS
4"	1	RST400NOS

<sup>1</sup> Contact Dixon for pressure information

### Notched NOS Ferrules

**Feature**

- Reference notched shanks above and adapters on page 45

Size	Hose O.D.		304 Stainless Steel Part #
	From	To	
1-1/2"	1-60/64"	2-12/64"	GAS2334NOS
	2-4/64"	2-22/64"	GAS2370NOS
2"	2-30/64"	2-44/64"	GAS2709NOS
	2-42/64"	2-54/64"	GAS2885NOS
3"	3-30/64"	3-46/64"	GAS3760NOS
	3-47/64"	3-54/64"	GAS3885NOS
4"	4-40/64"	4-47/64"	GAS5010NOS



NOTE: King Crimp® fittings, ferrules, and sleeves can be found on pages 5 - 17.

### Short Crimp Sleeves

**Features**

- For use with King combination nipples only
- A reliable alternative to band clamps
- Not for use with Dixon® King Crimp® Style shanks



Hose I.D.	Hose O.D.		Sleeve I.D.	Sleeve Wall Thickness	Sleeve Overall Length	Carbon Steel Part #
	From	To				
3/4"	1-5/64"	1-8/64"	1.1875"	.060"	1-1/4"	CSS075-3CS
	1-9/64"	1-12/64"	1.250"	.060"	1-1/4"	CSS075-4CS
	1-17/64"	1-20/64"	1.375"	.060"	1-1/4"	CSS075-6CS
1"	1-21/64"	1-24/64"	1.438"	.060"	1-1/2"	CSS100-3CS
	1-25/64"	1-28/64"	1.500"	.060"	1-1/2"	CSS100-4CS
	1-29/64"	1-32/64"	1.563"	.060"	1-1/2"	CSS100-5CS
	1-33/64"	1-36/64"	1.625"	.060"	1-1/2"	CSS100-6CS
	1-37/64"	1-40/64"	1.688"	.060"	1-1/2"	CSS100-7CS
	1-41/64"	1-44/64"	1.750"	.060"	1-1/2"	CSS100-8CS
	1-1/2"	1-41/64"	1-44/64"	1.750"	.060"	1-3/4"
1-45/64"		1-48/64"	1.813"	.060"	1-3/4"	CSS150-2CS
1-49/64"		1-52/64"	1.875"	.060"	1-3/4"	CSS150-3CS
1-53/64"		1-56/64"	1.938"	.060"	1-3/4"	CSS150-4CS
1-57/64"		1-60/64"	2.000"	.060"	1-3/4"	CSS150-5CS
1-61/64"		2"	2.063"	.060"	1-3/4"	CSS150-6CS
2-1/64"		2-4/64"	2.125"	.060"	1-3/4"	CSS150-7CS
2-5/64"		2-8/64"	2.188"	.060"	1-3/4"	CSS150-8CS
2-9/64"		2-12/64"	2.250"	.060"	1-3/4"	CSS150-9CS
2"	2-21/64"	2-24/64"	2.438"	.060"	2"	CSS200-3CS
	2-25/64"	2-28/64"	2.500"	.060"	2"	CSS200-4CS
	2-29/64"	2-32/64"	2.563"	.060"	2"	CSS200-5CS
	2-33/64"	2-36/64"	2.625"	.060"	2"	CSS200-6CS
	2-37/64"	2-40/64"	2.688"	.060"	2"	CSS200-7CS
	2-41/64"	2-44/64"	2.750"	.060"	2"	CSS200-8CS
	2-45/64"	2-48/64"	2.813"	.060"	2"	CSS200-9CS
	2-49/64"	2-52/64"	2.875"	.060"	2"	CSS200-10CS
	2-53/64"	2-56/64"	2.938"	.060"	2"	CSS200-11CS
	2-57/64"	2-60/64"	3.000"	.060"	2"	CSS200-12CS
	3"	3-13/64"	3-16/64"	3.313"	.090"	2-5/8"
3-17/64"		3-20/64"	3.375"	.090"	2-5/8"	CSS300-2CS
3-21/64"		3-24/64"	3.438"	.090"	2-5/8"	CSS300-3CS
3-25/64"		3-28/64"	3.500"	.090"	2-5/8"	CSS300-4CS
3-29/64"		3-32/64"	3.563"	.090"	2-5/8"	CSS300-5CS
3-33/64"		3-36/64"	3.625"	.090"	2-5/8"	CSS300-6CS
3-37/64"		3-40/64"	3.688"	.090"	2-5/8"	CSS300-7CS
3-41/64"		3-44/64"	3.750"	.090"	2-5/8"	CSS300-8CS
3-45/64"		3-48/64"	3.813"	.090"	2-5/8"	CSS300-9CS
3-49/64"		3-52/64"	3.875"	.090"	2-5/8"	CSS300-10CS
3-53/64"		3-56/64"	3.938"	.090"	2-5/8"	CSS300-11CS
3-57/64"		3-60/64"	4.000"	.090"	2-5/8"	CSS300-12CS
4"	4-29/64"	4-32/64"	4.563"	.090"	3-15/32"	CSS400-5CS
	4-33/64"	4-36/64"	4.625"	.090"	3-15/32"	CSS400-6CS
	4-37/64"	4-40/64"	4.688"	.090"	3-15/32"	CSS400-7CS
	4-41/64"	4-44/64"	4.750"	.090"	3-15/32"	CSS400-8CS
	4-45/64"	4-48/64"	4.813"	.090"	3-15/32"	CSS400-9CS
	4-49/64"	4-52/64"	4.875"	.090"	3-15/32"	CSS400-10CS
	4-53/64"	4-56/64"	4.938"	.090"	3-15/32"	CSS400-11CS
	4-57/64"	4-60/64"	5.000"	.090"	3-15/32"	CSS400-12CS



G

### King Steel Round Nipples For One Clamp

Hose Size	NPT Size	Unplated Steel Part #	Optional Qty
5/8"	1/2"	KRN541	100
3/4"	1/2"	KRN641	50
1"	3/4"	KRN861	25

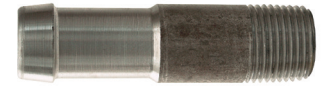

### King Steel Round Nipples For Two Clamps

Hose Size	NPT Size	Unplated Steel Part #	Optional Qty
1/2"	1/4"	KRN422	100
	3/8"	KRN432	100
5/8"	1/2"	KRN542	100
3/4"	1/2"	KRN642	50
	3/4"	KRN662	50
1"	3/4"	KRN862	50
	1"	KRN882	50
1-1/4"	1"	KRN1082	25
1-1/2"	1-1/4"	KRN1210	25
2"	1-1/2"	KRN1612	20



G

### King Steel Hex Nipples For One Clamp

Hose Size	NPT Size	Plated Steel Part #	Optional Qty
1/4"	1/4"	KHN221	50
	1/4"	KHN321	100
3/8"	3/8"	KHN331	100
	1/2"	KHN341	100
1/2"	1/4"	KHN421	50
	3/8"	KHN431	50
	1/2"	KHN441	50
3/4"	3/4"	KHN461	50
	1/2"	KHN641	50
3/4"	3/4"	KHN661	50
	3/4"	KHN861	25
1"	1"	KHN881	25



### King Steel Hex Nipples For Two Clamps

Hose Size	NPT Size	Plated Steel Part #	Optional Qty
1/4"	1/4"	KHN222	100
	1/4"	KHN322	100
3/8"	3/8"	KHN332	50
	1/2"	KHN342	100
1/2"	1/4"	KHN422	100
	3/8"	KHN432	100
	1/2"	KHN442	50
3/4"	3/4"	KHN462	50
	1/2"	KHN642	50
3/4"	3/4"	KHN662	50
	3/4"	KHN862	25
1"	1"	KHN882	25



Hose Shank x Male NPT Inserts



nylon



polypropylene

Size	Nylon Part #	Pkg Qty	Polypropylene Part #	Pkg Qty
1-1/4"	THN15	25	---	---
1-1/2"	THN20	25	HB150	25
2"	THN25	20	HB200	24
3"	THN35	10	HB300	10
4"	---	---	HB400	12



**Tuff-Lite®**

Hose Shank x Male NPT Insert

**Features**

- Additional material and sizes on page 1004
- Polypropylene fittings should not be used with aromatic hydrocarbons, carbon tetra-chloride, gasoline, hexane, kerosene, nitric acid, sodium hydrochlorite, toluene, trichloroethylene, or xylene
- Polypropylene should not be used with compressed gas
- Fittings are black



polypropylene

Hose Size	Male NPT	Pkg Qty	Polypropylene Part #	Pkg Qty
1/2"	1/2"	50	PPN44	50
3/4"	3/4"	50	PPN66	50
1"	1"	25	PPN88	25



## Dixon® Hose Menders

### Features

- Not for compressible products such as air, nitrogen, or steam
- The working pressure may vary with the construction of the hose, the type of clamping system used, and the application, consult Dixon for recommendations.
- In accordance with the ARPM bulletin for oil suction and discharge hose, a coupled length of hose in any size, should be tested to 1-1/2 times the working pressure and held for fifteen minutes without leaking or coupling movement; for additional information and detailed instruction on testing procedures, see the Association for Rubber Products Manufacturers' (ARPM) handbook or visit ARPMINC.com



Size	Zinc Plated Steel Part #	Optional Qty	316 Stainless Steel Part #	Optional Qty
1/4"	DMA	200	RDMA	100
3/8"	DMB	100	RDMB	100
1/2"	DM1	50	RDM1	50
5/8"	DM5	50	---	---
3/4"	DM6	50	RDM6	50
1"	DM11	50	RDM11	50
1-1/4"	DM16	50	RDM16	5
1-3/8"	DM18	50	---	---
1-1/2"	DM21	50	RDM21	50
1-1/2"	DMXL21 <sup>1</sup>	25	---	---
2"	DM26	50	RDM26	10
2"	DMXL26 <sup>1</sup>	25	---	---
2-1/2"	DM31	25	---	---
3"	DM36	20	RDM36	5
4"	DM46	10	RDM46	5
5"	DM51	5	---	---
6"	DM66	4	---	---
8"	DM86	1	---	---
10"	DM100	1	---	---
12"	DM120	1	---	---



zinc plated steel



316 stainless steel

G

<sup>1</sup> XL series has extra long shank

## King Hose Menders

### Features

- Not for compressible products such as air, nitrogen, or steam
- The working pressure may vary with the construction of the hose, the type of clamping system used, and the application, consult Dixon® for recommendations
- In accordance with the ARPM bulletin for oil suction and discharge hose, a coupled length of hose in any size, should be tested to 1-1/2 times the working pressure and held for fifteen minutes without leaking or coupling movement; for additional information and detailed instruction on testing procedures, see the Association for Rubber Products Manufacturers' (ARPM) handbook or visit ARPMINC.com



### For One Clamp

Size	Steel Part #
1/4"	KM21
5/16"	KM251
1/2"	KM41
5/8"	KM51
3/4"	KM61
1"	KM81
1-1/4"	KM101
1-1/2"	KM121

### For Two Clamps

Size	Steel Part #
1/2"	KM42
5/8"	KM52
3/4"	KM62
1"	KM82
1-1/4"	KM102
1-1/2"	KM122
2"	KM162

## Barbed Hose Menders

Hose I.D.	Lead Free Brass <sup>1</sup> Part #	Brass	
		Previous Part #	Part #
1/8"	---	BM1	1780202C
3/16"	---	BM15	1780303C
1/4" x 1/8"	---	BM2-1	1780402C
1/4"	1780404CLF	BM2	1780404C
5/16"	---	BM25	1780505C
3/8" x 1/4"	---	BM3-2	1780604C
3/8"	1780606CLF	BM3	1780606C
1/2" x 1/4"	---	---	1780804C
1/2" x 3/8"	---	BM4-3	1780806C
1/2"	1780808CLF	BM4	1780808C
5/8" x 3/8"	---	BM5-3	1781006C
5/8" x 1/2"	---	BM5-4	1781008C
5/8"	---	BM5	1781010C
3/4" x 1/2"	---	BM6-4	1781208C
3/4"	---	BM6	1781212C
1" x 3/4"	---	---	1781612C
1"	---	BM8	1781616C

<sup>1</sup> NSF®/ANSI 61 certified Lead Free Brass <=0.25% lead, Alloy C2745

## Short Shank Menders

Size	Length	Previous Part #	316 Stainless Steel Part #
1/4"	2-1/32"	1780404SS	RM2
3/8"	2-1/16"	1780606SS	RM3
1/2"	2-1/16"	1780808SS	RM4
3/4"	2-1/2"	1781212SS	RM6

G



**Tuff-Lite®**  
Menders

**Specification**

- Maximum working temperature: 150°F (66°C)

Size	Nylon Part #	Polypropylene Part #	Pkg Qty
1/4"	TM2	PPM2	50
5/16"	TM25	---	---
3/8"	TM3	PPM3	50
1/2"	TM4	PPM4	50
5/8"	TM5	PPM5	50
3/4"	TM6	PPM6	50
1"	TM8	PPM8	50
1-1/4"	TM16	---	---
1-1/2"	TM21	---	---
2"	TM26	---	---
4"	TM46	---	---
6"	TM66	---	---



nylon



polypropylene

G

NOTE: Sold in package quantities only

**Push-On Hose Menders**

**Feature**

- No clamps needed when used with push-on hose

Size	Nylon Part #	Pkg Qty
1/4"	TPM2	50
3/8"	TPM3	50
1/2"	TPM4	50



NOTE: Sold in package quantities only

## King Short Shank Suction Hose Couplings

NPSM Thread

### Application

- For suction or discharge of water

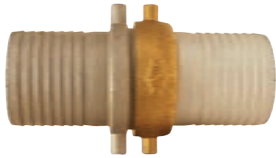

complete



female



1" - 2-1/2"  
male

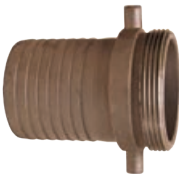

3" - 6"  
male

Size	Aluminum Shank with Brass Nut Complete Part #	Opt Qty	Aluminum Shank with Brass Nut Female Part #	Aluminum Male Part #
1-1/2"	CAB150	60	FAB150	MA150
2"	CAB200	40	FAB200	MA200
2-1/2"	CAB250	30	FAB250	MA250
3"	CAB300	18	FAB300	MA300
4"	CAB400	8	FAB400	MA400
6"	CAB600	6	FAB600	MA600

Size	Brass Shank with Brass Nut Complete Part #	Brass Shank with Brass Nut Female Part #	Brass Male Part #
1-1/4"	CBB125	FBB125	MB125
1-1/4"	CBB150	FBB150	MB150
2"	CBB200	FBB200	MB200
2-1/2"	CBB250	FBB250	MB250
3"	CBB300	FBB300	MB300
4"	CBB400	FBB400	MB400

Size	Plated Iron Shank with Plated Iron Nut Complete Part #	Plated Iron Shank with Plated Iron Nut Female Part #	Plated Iron Male Part #
1"	S33 <sup>1</sup>	S12 <sup>1</sup>	S10
1-1/4"	S48	S17	S15
1-1/2"	S63	S22	S20
2"	S78	S27	S25
2-1/2"	S93	S32	S30
3"	S111	S38	S36
4"	S123	S42	S40
5"	---	S57	S55
6"	S183	S62	S60

Size	Plated Iron Shank with Brass Nut Complete Part #	Plated Iron Shank with Brass Nut Female Part #	Plated Iron Male Part #
1"	SB33 <sup>1</sup>	SB12 <sup>1</sup>	S10
1-1/2"	SB48	SB17	S15
1-1/2"	SB63	SB22	S20
2"	SB78	SB27	S25
2-1/2"	SB93	SB32	S30
3"	SB111	SB38	S36
4"	SB123	SB42	S40
5"	---	SB57	S55
6"	SB183	SB62	S60

<sup>1</sup> 1" fittings have a hex nut design

NOTE: Complete couplings supplied with rubber gaskets

Replacement gaskets (KRW standard) are available. See page 377.

G

## King Short Shank Suction Hose Couplings

### NST Couplings

**Application**

- For suction or discharge of water

Size	Aluminum Shank with Brass Nut Complete Part #	Aluminum Shank with Brass Nut Female Part #	Aluminum Male Part #
1-1/2"	CAB150N	FAB150N	MA150N
2-1/2"	CAB250N	FAB250N	MA250N

Size	Brass Shank with Brass Nut Complete Part #	Brass Shank with Brass Nut Female Part #	Brass Male Part #
1-1/2"	BS63N	BS22N	BS201
2-1/2"	BS93N	BS32N	BS301

Size	Plated Iron Shank with Plated Iron Nut Complete Part #	Plated Iron Shank with Plated Iron Nut Female Part #	Plated Iron Male Part #
1-1/2"	S63N	S22N	S201
2-1/2"	S93N	S32N	S301

Size	Plated Iron Shank with Brass Nut Complete Part #	Plated Iron Shank with Brass Nut Female Part #	Plated Iron Male Part #
1-1/2"	SB63N	SB22N	S201
2-1/2"	SB93N	SB32N	S301

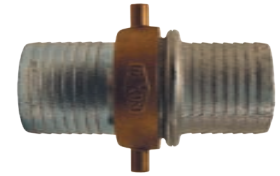

complete



female



male



NOTE: NST (Common Fire Hose thread) is also known as NH  
Replacement gaskets (KRW standard) are available. See page 377.

## Steel King Short Shank Suction Couplings

### NPSM Couplings

**Application**

- For suction or discharge of water

Size	Plated Steel Shank with Plated Iron Nut Complete Part #	Plated Steel Shank with Plated Iron Nut Female Part #	Plated Steel Male Part #
1-1/4"	CSM125	FCSM125	MCS125
1-1/2"	CSM150	FCSM150	MCS150
2"	CSM200	FCSM200	MCS200
2-1/2"	CSM250	FCSM250	MCS250
3"	CSM300	FCSM300	MCS300
4"	CSM400	FCSM400	MCS400
6"	CSM600	FCSM600	MCS600

Size	Plated Steel Shank with Brass Nut Complete Part #	Plated Steel Shank with Brass Nut Female Part #	Plated Steel Male Part #
1-1/4"	CSB125	FCSB125	MCS125
1-1/2"	CSB150	FCSB150	MCS150
2"	CSB200	FCSB200	MCS200
2-1/2"	CSB250	FCSB250	MCS250
3"	CSB300	FCSB300	MCS300
4"	CSB400	FCSB400	MCS400
6"	CSB600	FCSB600	MCS600



complete



female

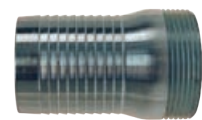

male

NOTE: Replacement gaskets (KRW standard) are available. See page 377.

## Super King Long Shank Hose Couplings

### Female NPSM Couplings

**Application**

- For liquid transfer where steel and stainless are preferred



pin lug nut



hex nut

Size	Shank Length	Plated Steel Shank with Brass Pin Lug Nut <sup>1</sup> Part #	Plated Steel Shank with Iron Pin Lug Nut <sup>1</sup> Part #
1-1/4"	4-1/8"	SD15	SDMP15
1-1/2"	4-1/8"	SD20	SDMP20
2"	5"	SD25	SDMP25
2-1/2"	5"	SD30	SDMP30
3"	5"	SD35	SDMP35
4"	5"	SD40	SDMP40

Size	Shank Length	316 Stainless Shank with Iron Pin Lug Nut <sup>1</sup> Part #	316 Stainless Shank with Stainless Hex Nut <sup>2</sup> Part #
1-1/2"	4-1/8"	---	RSHR20
2"	5"	RSDM25	RSDR25
3"	5"	RSDM35	---

<sup>1</sup> K LW leather gaskets standard

<sup>2</sup> PTFE gaskets standard

### Male NPT Couplings



Size	Shank Length	Plated Steel Part #	316 Stainless Part #
1-1/4"	4-3/8"	SK16	RSK16
1-1/2"	4-5/32"	SK21	---
2"	5-5/16"	SK26	RSK26
2-1/2"	5-5/16"	SK31	---
3"	5-1/2"	SK36	RSK36
4"	5-1/2"	SK46	---

NOTE: All Super King long shank couplings accept three band clamps

## Pin Lug Spanner Wrenches

### Single End



Size	Plated Iron Part #
2"	SW20
2-1/2"	SW25
3"	SW30
4"	SW40
6"	SW60

### Double End



Size	Plated Iron Part #
1-1/2", 2" x 2-1/2", 3"	SW153

NOTE: Additional spanner wrenches are available on pages 828 - 831

## Short Shank Hose Couplings

## Complete NPSM Couplings

Size	316 Stainless Steel Part #
1/2"	RES404
3/4"	RES606
1"	RES808
1-1/4"	RES48
1-1/2"	RES63
2"	RES78

NOTE: Standard gasket is rubber (KRW); for FKM gaskets (KVW) see page 377.



## Female NPSM Couplings

Size	316 Stainless Steel Part #
1/2"	RES444
3/4"	RES646
1"	RES848
1-1/4"	RES33
1-1/2"	RES43
2"	RES53

NOTE: Standard gasket is rubber (KRW); for FKM gaskets (KVW) see page 377.



G

## Machined Short Shank Hose Couplings

## Complete NPSM Couplings

Hose I.D.	NPSM Thread	Previous Part #	Brass Part #
1/2"	3/4"	---	BS406
3/4"	3/4"	---	BS606
1"	1"	BS808 <sup>1</sup>	5921616K <sup>1,2</sup>

<sup>1</sup> NPSH threads

<sup>2</sup> Washer is 5911212W

NOTE: Use with KRW washers on page 377



## Female NPSM Couplings

Hose I.D.	NPSM Thread	Previous Part #	Brass Part #
1/2"	3/4"	---	BS446
5/8"	3/4"	---	BS546
3/4"	3/4"	---	BS646
1"	1"	BS848 <sup>1</sup>	5911616C <sup>1,2,3</sup>

<sup>1</sup> NPSH threads

<sup>2</sup> Washer is 5911212W

<sup>3</sup> Lead-free option available on page 420 of catalog

NOTE: Use with KRW washers on page 377

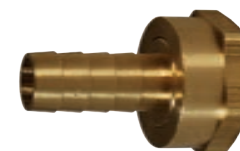

## Male NPSM Couplings

Hose I.D.	NPSM Thread	Previous Part #	Brass Part #
1/2"	3/4"	---	BS416
3/4"	3/4"	---	BS616
1"	1"	BS818 <sup>1</sup>	5901616C <sup>1,2</sup>

<sup>1</sup> NPSH threads

<sup>2</sup> Lead-free option available on page 420 of catalog

NOTE: Use with KRW washers on page 377



## Long Shank Hose Couplings

### Complete NPSM Couplings

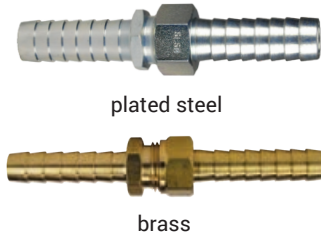

Hose I.D.	NPSM Thread	Plated Steel Part #	Plated Iron Part #	Previous Part #	Brass Part #
1/2"	1/2"	SLS404	---	---	BLS404
1/2"	3/4"	---	---	---	BLS406
5/8"	3/4"	---	---	---	BLS506
3/4"	3/4"	SLS606	---	---	BLS606
1"	1"	SLS808	---	BLS808	5951616K <sup>1,2</sup>
1-1/4"	1-1/4"	---	MLS48	---	BLS48
1-1/2"	1-1/2"	---	MLS63	---	BLS63
2"	2"	---	MLS78	---	BLS78

<sup>1</sup> NPSH thread

<sup>2</sup> Washer is 5911616W

NOTE: Sizes 1/2" to 1" are machined; 1-1/4" to 2" are cast

Replacement gaskets (KRW standard) available on page 377

### Female NPSM Couplings

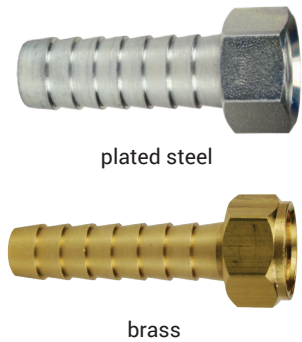

Hose I.D.	NPSM Thread	Plated Steel Part #	Plated Iron Part #	Previous Part #	Brass Part #
1/2"	1/2"	SLS444	---	---	BLS444
1/2"	3/4"	---	---	---	BLS446
5/8"	3/4"	---	---	---	BLS546
3/4"	3/4"	SLS646	---	---	BLS646
1"	1"	SLS848	---	BLS848	5941616C <sup>1,2</sup>
1-1/4"	1-1/4"	---	MLS33	---	BLS33
1-1/2"	1-1/2"	---	MLS43	---	BLS43
2"	2"	---	MLS53	---	BLS53

<sup>1</sup> NPSH thread

<sup>2</sup> Washer is 5911616W

NOTE: 1/2" to 1" are machined; 1-1/4" to 2" are cast

Replacement gaskets (KRW standard) available on page 377

### Male NPSM Couplings

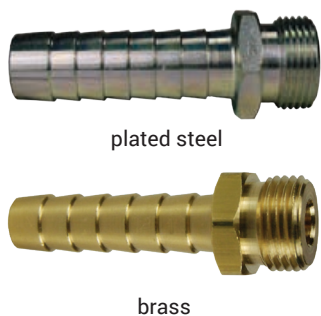

Hose I.D.	NPSM Thread	Plated Steel Part #	Plated Iron Part #	Previous Part #	Brass Part #
1/2"	1/2"	SLS414	---	---	BLS414
1/2"	3/4"	---	---	---	BLS416
5/8"	3/4"	---	---	---	BLS516
3/4"	3/4"	SLS616	---	---	BLS616
1"	1"	SLS818	---	BLS818	5931616C <sup>1</sup>
1-1/4"	1-1/4"	---	MLS15	---	BLS15
1-1/2"	1-1/2"	---	MLS20	---	BLS20
2"	2"	---	MLS25	---	BLS25

<sup>1</sup> NPSH thread

NOTE: 1/2" to 1" are machined; 1-1/4" to 2" are cast



## Long Shank Hose Couplings

### Complete NST Couplings

Hose I.D.	NST Thread	Brass Part #
1-1/2"	1-1/2"	BLS63NST
2-1/2"	2-1/2"	BLS93NST



NOTE: Replacement gaskets (KRW standard) available on page 377  
 For GHT long shank complete couplings, see page 422

### Female NST Couplings

Hose I.D.	NST Thread	Brass Part #
1-1/2"	1-1/2"	BLS150NST
2-1/2"	2-1/2"	BLS250NST

**G**

NOTE: Replacement gaskets (KRW standard) available on page 377  
 For GHT long shank female coupling, see page 422

### Male NST Couplings

Hose I.D.	NST Thread	Brass Part #
1-1/2"	1-1/2"	BLS20NST
2-1/2"	2-1/2"	BLS30NST



NOTE: For GHT long shank male coupling, see page 422

## Spray Hose Couplings

### Complete NPSM Couplings



Hose I.D.	NPSM Thread	Plated Steel Part #
3/8"	3/4"	SS306
1/2"	1/2"	SS404
1/2"	3/4"	SS406
3/4"	3/4"	SS606
1"	1"	SS808

NOTE: For GHT spray hose complete coupling, see page 420  
Replacement KLW (leather gaskets) standard, can be found on page 377

### Female NPSM Couplings

G



Hose I.D.	NPSM Thread	Plated Steel Part #
3/8"	3/4"	SS346
1/2"	1/2"	SS444
1/2"	3/4"	SS446
3/4"	3/4"	SS646
1"	1"	SS848

NOTE: For GHT spray hose female coupling, see page 420  
Replacement KLW (leather gaskets) standard, can be found on page 377

### Male NPSM Couplings



Hose I.D.	NPSM Thread	Plated Steel Part #
3/8"	3/4"	SS316
1/2"	1/2"	SS414
1/2"	3/4"	SS416
3/4"	3/4"	SS616
1"	1"	SS818

NOTE: For GHT spray hose male coupling, see page 420

## Gaskets for Suction, Short, Long, and Spray Hose Couplings

### Feature

- For use on NPSM threaded couplings

Hose I.D.	Rubber (Styrene Butadiene) Part #	Neoprene Part #	FKM Part #
1/2"	KRW1	---	---
3/4"	KRW5	KNW5	---
1"	KRW10	KNW10	KVW10
1-1/4"	KRW15	KNW15	---
1-1/2"	KRW20	KNW20	KVW20
2"	KRW25	KNW25	KVW25
2-1/2"	KRW30	KNW30	---
3"	KRW35	KNW35	KVW35
4"	KRW40	KNW40	---
5"	KRW50	---	---
6"	KRW60	KNW60	---
8"	KRW80	KNW80	---

Hose I.D.	Leather Part #	Rubber Part #
1/2"	KLW1	---
3/4"	KLW5	---
1"	KLW10	---
1-1/4"	KLW15	---
1-1/2"	KLW20	KRW2075 <sup>1</sup>
2"	KLW25	---
2-1/2"	KLW30	KRW3075 <sup>1</sup>
3"	KLW35	---
4"	KLW40	---

<sup>1</sup> NST only threaded couplings



rubber



neoprene



FKM



leather



rubber

G

## Type A

### Application

- Used primarily on irrigation and suction lines

### Features

- Hot dipped, galvanized
- Has a double pin locking lever for smooth closing action
- Type A Agri-Lock style locks on female style
- Each coupler is equipped with a safety pin to prevent accidental openings.
- These fittings are not recommended for chemicals or any hazardous type materials where the possibility of leakage would result in health or environmental concerns, consult Dixon® for recommendations



### Female with Hose Shank

#### Feature

- Supplied with gasket

Size	Galvanized Steel Part #
10"	FC21210
12"	FC21212 <sup>1</sup>

<sup>1</sup> 12" supplied with M20412 lever assist bar found on page 381

### Female with Machined Hose Shank

#### Features

- Dixon combination nipple style hose shank machined from Schedule 40 pipe
- Recommended for use with steel King Crimp® sleeves
- Supplied with gasket

Size	Galvanized Steel Part #
10"	FC21210ST100
12"	FC21212ST120 <sup>1</sup>

<sup>1</sup> 12" supplied with M20412 lever assist bar found on page 381

### Female with 150# ASA Flange

#### Feature

- Supplied with gasket

Size	Galvanized Steel Part #
10"	FC22310
12"	FC22312 <sup>1</sup>

<sup>1</sup> 12" supplied with M20412 lever assist bar found on page 381

NOTE: For flange dimensions, diagrams, and additional information, please reference [dixonvalve.com](http://dixonvalve.com).

G



10"



12"



12"

## Type A

### Male with Hose Shank

Size	Galvanized Steel Part #
10"	MC21110
12"	MC21112



### Male with Machined Hose Shank

**Features**

- Dixon® combination nipple style hose shank machined from Schedule 40 pipe
- Recommended for use with steel King Crimp® sleeves

Size	Galvanized Steel Part #
10"	MC21110ST100
12"	MC21112ST120



G

### Male with 150# ASA Flange

Size	Galvanized Steel Part #
10"	MC22210
12"	MC22212



NOTE: For flange dimensions, diagrams, and additional information, please reference [dixonvalve.com](http://dixonvalve.com).

**Type A**

**Male x Female 90° Elbows**



12"

**Feature**

- Supplied with gasket

Size	Galvanized Steel Part #
10"	EL21510-90
12"	EL21512-90 <sup>1</sup>

<sup>1</sup> 12" supplied with M20412 lever assist bar on page 381

**Female for Welding to Pipe**



12"

Size	Unplated Steel Part #
10"	20410
12"	20412

**Males with Ring for Welding**



Size	Unplated Steel Part #
10"	21010
12"	21012

**Female Plugs**

**Feature**

- Supplied with gasket



10"

Size	Galvanized Steel Part #
10"	FP20910
12"	FP20912 <sup>1</sup>

<sup>1</sup> 12" supplied with M20412 lever assist bar on page 381

G

**Type A**

**Male Plugs with Ring**

Size	Galvanized Steel Part #
10"	MP21010
12"	MP21012



**Gaskets**

Size	Rubber Part #	EPDM Part #
10"	RG20510	RG20610
12"	RG20512	RG20612



**G**

**Lever Assist Bar**

Size	Galvanized Steel Part #
12"	M20412



**Quick Connect Safety Pin**

Size	Galvanized Steel Part #
12"	SP290



**Type B**

**Application**

- Used primarily on irrigation and suction lines

**Features**

- Hot dipped, galvanized
- Has a double pin locking lever for smooth closing action
- Type B (Bauer style) locks on the male side
- Each coupler is equipped with a safety pin to prevent accidental openings.
- These fittings are not recommended for chemicals or any hazardous type materials where the possibility of leakage would result in health or environmental concerns, consult Dixon for recommendations



**Male x Hose Shank**

G



Size	Galvanized Steel Part #
2"	MC3092
3"	MC3093
4"	MC3094
6"	MC3096
8"	MC3098
10"	MC30910 <sup>1</sup>
12"	MC30912 <sup>1</sup>

<sup>1</sup> 10" and 12" supplied with ACB304 lever assist bar on page 386

**Male with Male NPT**



Size	Galvanized Steel Part #
2"	MCM3112
3"	MCM3113
4"	MCM3114
6"	MCM3116
8"	MCM3118

**Female x Hose Shank**

**Feature**

- Supplied with gasket



Size	Galvanized Steel Part #
2"	FC3102
3"	FC3103
4"	FC3104
6"	FC3106
8"	FC3108
10"	FC31010
12"	FC31012

**Female with Male NPT**

**Feature**

- Supplied with gasket



Size	Galvanized Steel Part #
2"	FCM3122
3"	FCM3123
4"	FCM3124
6"	FCM3126
8"	FCM3128



## Type B

### Male with Machined Hose Shank

#### Features

- Dixon® combination nipple style hose shank machined from Schedule 40 pipe
- Recommended for use with steel King Crimp® sleeves

Size	Galvanized Steel Part #
2"	MC3092ST25
3"	MC3093ST35
4"	MC3094ST40
6"	MC3096ST60
8"	MC3098ST80



### Male x 150# ASA Flange

Size	Galvanized Steel Part #
4"	MC3134
6"	MC3136
8"	MC3138
10"	MC31310 <sup>1</sup>
12"	MC31312 <sup>1</sup>

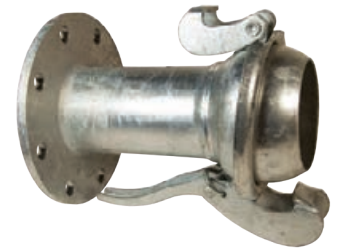

<sup>1</sup> 10" and 12" supplied with ACB304 lever assist bar on page 386

NOTE: For flange dimensions, diagrams, and additional information please reference [dixonvalve.com](http://dixonvalve.com).

### Male Weld-On

Size	Unplated Steel Part #
2"	3032
3"	3033
4"	3034
6"	3036
8"	3038
10"	30310
12"	30312



NOTE: Female and male fittings are commonly used for butt-welding to pipe

### Heavy Duty Female x Dixon Combination Nipple Hose Shank

Size	Galvanized Steel Part #
2"	FC3102ST25
3"	FC3103ST35
4"	FC3104ST40
6"	FC3106ST60
8"	FC3108ST80

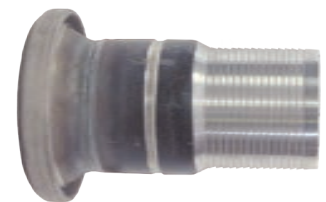

**Type B**

**Female x 150# ASA Flange**



**Feature**

- Supplied with gasket

Size	Galvanized Steel Part #
4"	FC3144
6"	FC3146
8"	FC3148
10"	FC31410
12"	FC31412

NOTE: For flange dimensions, diagrams and additional information please reference [dixonvalve.com](http://dixonvalve.com).

**Female Weld-On with Gasket**

**Feature**

- Supplied with gasket



Size	Unplated Steel Part #
2"	3022
3"	3023
4"	3024
6"	3026
8"	3028
10"	30210
12"	30212

**Male x Female 90° Elbow**

**Feature**

- Supplied with gasket



Size	Galvanized Steel Part #
4"	EL3154-90
6"	EL3156-90
8"	EL3158-90
10"	EL31510-90 <sup>1</sup>
12"	EL31512-90 <sup>1</sup>

<sup>1</sup> 10" and 12" supplied with ACB304 lever assist bar on page 386

**Male x Female 45° Elbow**

**Feature**

- Supplied with gasket



Size	Galvanized Steel Part #
4"	EL3154-45
6"	EL3156-45
8"	EL3158-45
10"	EL31510-45 <sup>1</sup>
12"	EL31512-45 <sup>1</sup>

<sup>1</sup> 10" and 12" supplied with ACB304 lever assist bar on page 386

G

## Type B

### Female x Male Reducer

**Feature**

- Supplied with gasket

Female Size	Male Size	Galvanized Steel Part #
6"	4"	FMR31864
8"	6"	FMR31886
10"	8"	FMR318108 <sup>1</sup>
12"	10"	FMR3181210 <sup>1</sup>



<sup>1</sup> 10" and 12" supplied with ACB304 lever assist bar on page 386

### Female x Male Increaser

**Feature**

- Supplied with gasket

Female Size	Male Size	Galvanized Steel Part #
4"	6"	FMI31946
6"	8"	FMI31968
8"	10"	FMI319810
10"	12"	FMI3191012 <sup>1</sup>



**G**

<sup>1</sup> 10" and 12" supplied with ACB304 lever assist bar on page 386

### Male with Male NPT- extra long

Size	Galvanized Steel Part #
2"	MCM3112XL
3"	MCM3113XL
4"	MCM3114XL
6"	MCM3116XL
8"	MCM3118XL

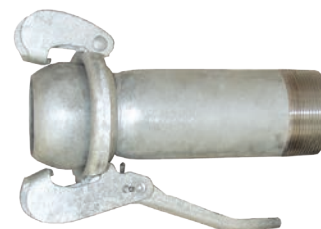

### Male Plugs

Size	Galvanized Steel Part #
2"	MP3232
3"	MP3233
4"	MP3234
6"	MP3236
8"	MP3238
10"	MP32310 <sup>1</sup>
12"	MP32312 <sup>1</sup>



<sup>1</sup> 10" and 12" supplied with ACB304 lever assist bar on page 386

**Type B**

**Female Plugs**

**Feature**

- Supplied with gasket



Size	Galvanized Steel Part #
2"	FP3082
3"	FP3083
4"	FP3084
6"	FP3086
8"	FP3088
10"	FP30810
12"	FP30812

**Lever Rings**

G



Size	Galvanized Steel Part #
2"	LR3042
3"	LR3043
4"	LR3044
6"	LR3046
8"	LR3048
10"	LR30410
12"	LR30412

**Lever Assist Bar**



Size	Description	Galvanized Steel Part #
10" and 12"	lever assist bar for type B fittings	ACB304

**Gaskets**



Size	Rubber Part #	EPDM Part #
2"	RG3052	RG3062
3"	RG3053	RG3063
4"	RG3054	RG3064
6"	RG3056	RG3066
8"	RG3058	RG3068
10"	RG30510	RG30610
12"	RG30512	RG30612

**Quick Connect Safety Clips**

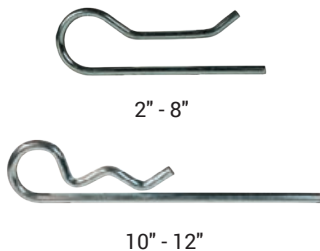

Size	Galvanized Steel Part #
2"	SP59
3"	SP76
4"	SP89
6"	SP159
8"	SP159
10"	SP390
12"	SP390

## Polyethylene Crimp Bauer Style - Type A

### Male

**Application**

- The primary application for these fittings are irrigation and suction lines

**Features**

- Pins sold separately
- Locks are on the female size

Size	Galvanized in Centrifugation Part #
12"	MC21112-PC



### Female

**Application**

- The primary application for these fittings are irrigation and suction lines

**Feature**

- Includes gasket

Size	Galvanized in Centrifugation Part #
12"	FC21212-PC



## Polyethylene Crimp Bauer Style - Type B

### Male

**Application**

- The primary application for these fittings are irrigation and suction lines

**Feature**

- Pins sold separately



Size	Galvanized in Centrifugation Part #
4"	MC3094-PC
6"	MC3096-PC
8"	MC3098-PC
12"	MC30912-PC

### Female

**Application**

- The primary application for these fittings are irrigation and suction lines

**Features**

- Locks on the female size
- Includes gasket



Size	Galvanized in Centrifugation Part #
4"	FC3104-PC
6"	FC3106-PC
8"	FC3108-PC
12"	FC31012-PC

G

## Strainers

### Application

- Used on the submersed end of suction hose to prevent debris from entering the pump during operation

### Round Hole Strainers

NPSM Size	Zinc Plated Steel Part #	304 Stainless Steel Part #
3/4"	RHS5	---
1"	RHS10	---
1-1/2"	RHS20	RRHS20
2"	RHS25	RRHS25
2-1/2"	RHS30	---
3"	RHS35	RRHS35
4"	RHS40	RRHS40
6"	RHS60	RRHS60
8"	RHS80	---
10"	RHS100	---
12"	RHS120	---



zinc plated steel



304 stainless steel

G

### Square Hole Strainers

NPSM Size	Zinc Plated Steel Part #
2"	SHS25
3"	SHS35
4"	SHS40
6"	SHS60
8"	SHS80
10"	SHS100
12"	SHS120



### Polypropylene Strainers

NPT Size	Black Polypropylene with 30% fiberglass Part #
1-1/2"	TSS20
2"	TSS25
3"	TSS35
4"	TSS40



### Round Hole Long Strainers

NPSM Size	Zinc Plated Steel Part #
1-1/2"	RSS20
2"	RSS25
3"	RSS35
4"	RSS40



## Skimmers

### Round Hole Bottom Skimmers



NPSM Size	Zinc Plated Steel Part #
1-1/2"	DSB20
2"	DSB25
3"	DSB35



### Round Hole Top Skimmers

NPSM Size	Zinc Plated Steel Part #
1-1/2"	DST20
2"	DST25
3"	DST35

## Flexible Strainers



### Applications

- Used on the submerged end of the suction hose to prevent debris from entering the pump during operation
- Open or underground areas, roadways, mining, or any area affected by excess water where pumping is required

### Features

- Keeps your pumps running longer, saving you time and money
- Advanced flexible dewatering and filtration devices for harsh environments
- Designed to survive in hostile and high traffic environments
- Can withstand extreme conditions such as being run over by vehicles and machinery
- Costs less than conventional strainers, saving time in cleaning and replacements
- Vulcanised polymers eliminates sharp edges
- Lightweight and flexible design provides less impact when in contact with personnel or machinery
- Quick and easy to clean
- Protect the pump leading to less downtime, personnel intervention, and repair and maintenance
- For other end configurations: NPT and NST, contact Dixon

### Material

- Elastomeric polymers

### Specifications

- Flow rate: **224 GPM**
- Minimum temperature: **-87°F (-66°C)**
- Maximum temperature: **212°F (100°C)**

### Approval

- Manufactured in accordance to ISO:9001



FLSS200



FLSS200-A

Size	Hose Barb	Hole	Width	Length	Description	Part #
2"	2"	8 mm	3-1/2"	14.57"	flexible strainer	FLSS200
	---				flexible strainer without hose barb	FLSS200-A

### BSP Filters

Size	Thread Size	Hole	Width	Length	Description	Part #
2"	1-1/2"	3 mm	63 mm	370 mm	flexible strainer with female BSP	FLSS200-BSP3
		5 mm				FLSS200-BSP5
		8 mm				FLSS200-BSP8

### NPT Filters

Size	Thread Size	Hole	Width	Length	Description	Part #
2"	1-1/2"	3 mm	63 mm	370 mm	flexible strainer with female NPT	FLSS200-NPT3
		5 mm				FLSS200-NPT5
		8 mm				FLSS200-NPT8



## Foot Valves

### Application

- For use on water suction hose to prevent pump from losing its prime
- Must be installed in the vertical position
- For water service only
- Not for compressed air or other compressible gases



NPT Size	Painted Cast Iron Part #
1-1/2"	DFVS20
2"	DFVS25
2-1/2"	DFVS30
3"	DFVS35
4"	DFVS40
6"	DFVS60
8"	DFVS80



### Strainers

Size	Painted Cast Iron Part #
1-1/2"	FVS20
2"	FVS25
2-1/2"	FVS30
3"	FVS35
4"	FVS40
6"	FVS60
8"	FVS80



### Flapper Assemblies

Size	Painted Cast Iron / Rubber Part #
1-1/2"	FVFA20
2"	FVFA25
2-1/2"	FVFA30
3"	FVFA35
4"	FVFA40
6"	FVFA60
8"	FVFA80



### Flapper Gaskets

Size	Rubber Part #
1-1/2"	FVL20
2"	FVL25
2-1/2"	FVL30
3"	FVL35
4"	FVL40
6"	FVL60
8"	FVL80



### Seat Plates

Size	Painted Cast Iron Part #
1-1/2"	FVSP20
2"	FVSP25
2-1/2"	FVSP30
3"	FVSP35
4"	FVSP40
6"	FVSP60
8"	FVSP80



### Washdown / Mixing Stations .....393 - 394

Water-steam washdown station .....	393
Bronze hot and cold water mixing station.....	393
Rack for mixing station.....	393
Steam and cold water mixing station .....	394
Stainless steel hot and cold water mixing station.....	394
Hot or cold water mixing station.....	394

### Washdown Nozzles.....395 - 398

Thermal-Gard™ elevated temperature spray .....	395
Swivel connectors for washdown spray guns.....	395
Ball type swivel x hose shank.....	395
Straight swivel x hose shank .....	395
Straight swivel x GHT thread .....	395
Hot water washdown spray.....	396
Lite washdown spray .....	396
Mini spray .....	397
Spray .....	397
Washdown wand.....	397
Temperature indicating spray .....	398
Stainless steel industrial grade spray.....	398
Brass industrial grade front lever spray.....	398

### Pressure Washing .....399 - 409

E-Series hydraulic couplings .....	399 - 401
Spray guns.....	402
Anti-fatigue .....	402
Pressure.....	402
Heavy duty anti-fatigue.....	402
Pressure with extension .....	402
Pressure with hose, nozzle & lance.....	402
Spray lances and extensions for pressure gun.....	403
Spray lances .....	403
Dual spray lances .....	403
Molded grip extensions.....	403
Vented grip lances.....	403
Telescoping lance and belt for pressure gun .....	404
Swiveling quick couplings .....	404
Fixed plugs .....	405
Sewer nozzles .....	405
Injector nozzles .....	405
Line strainer.....	405
High pressure spray soap nozzles .....	406
High pressure spray nozzles .....	406
Quick connect soap nozzle .....	406
Quick connect spray nozzle .....	406
Multi-pack quick connect nozzles.....	406
Multi-pack high pressure spray nozzles .....	406
Spray nozzle selection guidelines.....	407

Turbo nozzles .....	408
Nozzle holders.....	408
Inlet filter for turbo nozzles .....	408
Balance release valve .....	408
Water broom.....	408
Unloader valves.....	409
Thermal relief valve.....	409
Safety release valve .....	409
Braided hose.....	409
Hand crank hose reel.....	409

### Garden Hose and Fittings.....410 - 424

Hose.....	410 - 411
Fog nozzles .....	412
Hydrant adapters .....	412
Washers .....	412
Sweeper .....	413
Water .....	413
Flexible.....	413
Brass / rubber power flow .....	413
Heavy duty hot water .....	413
Insulated .....	413
Pistol-grip.....	413
Twist .....	413
Adjust-A-Power.....	414
Constant flow nozzle displays .....	414
Constant flow nozzle with bumper .....	414
Plain hose nozzle .....	414
Compression bibb faucet .....	415
Quick connect assembly .....	415
Valves .....	416
Y .....	416
Manifold.....	417
Back flow preventer .....	417
Radiator bibb.....	417
Gooseneck.....	417
GHT zinc .....	418
Spray valve and hose assembly.....	418
Spray hose.....	419
Standard shanks .....	419 - 420
Short shanks .....	421
Long shank .....	422
Garden hose cap .....	422
Garden hose round nut with knurl.....	422
Garden hose hex nut with knurl.....	422
GHT adapters .....	423 - 424

### Water-Steam Washdown Station

**Application**

- Fail-safe mixing station safely blends steam and cold water for hot water on demand. Should cold water fail, the steam is instantly shut-off

**Features**

- Globe style control valves
- Dial thermometer
- In-line check valves
- 3/4" inlet and outlet
- Mounting plate and hardware for wall mounting

**Material**

- Stainless steel hose rack

**Specifications**

- Maximum operating pressure: **150 PSI**
- Maximum temperature: **200°F (93°C)**

**Bronze  
Part #**

SWDS

#### Pressure Requirements

Steam Pressure		Water Pressure	
Minimum 80 PSI	Maximum 90 PSI	Minimum 50 PSI	Maximum 80 PSI



Station is not supplied with hose and nozzle



### Hot and Cold Water Mixing Station

**Features**

- Globe style control valves
- In-line check valves
- 3/4" inlet and outlet
- Mounting plate and hardware for wall mounting

**Material**

- Stainless steel hose rack

**Specifications**

- Maximum operating pressure: **150 PSI**
- Maximum temperature: **200°F (93°C)**

**Bronze  
Part #**

WDS1



Station is not supplied with hose and nozzle

### Rack for Mixing Station

**Features**

- Supplied with mounting hardware
- Rack fits SWDS and WDS1 mixing stations
- Holds 50' of 3/4" heavy duty industrial grade hose

**Materials**

- Stainless steel lag screws
- Solid brass mounting crowns

**Stainless Steel  
Part #**

WDSR



### Steam and Cold Water Mixing Station



**Application**

- Front line mixing unit

**Features**

- New innovative design that provides secondary outlet for piping
- Unit is convenient and safe and allows easy maintenance
- Operates with as little as **30 PSI**
- Control valves (globe style)
- 3/4" inlet and outlet
- Temperature gauge (optional, stainless steel)
- Stainless steel mixer body, check valves, and hose rack
- Mounting plate and hardware for wall mounting

**Specifications**

- Maximum operating pressure: **150 PSI**
- Maximum temperature: **200°F (93°C)**

---

**304 Stainless Steel Part #**

SWDS-SS

### Hot and Cold Water Mixing Station



**Features**

- Control valves (globe style)
- 3/4" inlet and outlet
- Temperature gauge (optional, stainless steel)
- Stainless steel hose rack
- Mounting plate and hardware for wall mounting

**Specifications**

- Maximum operating pressure: **150 PSI**
- Maximum temperature: **200°F (93°C)**

---

**304 Stainless Steel Part #**

WDS1-SS

### Hot or Cold Water Mixing Station



**Features**

- Control valves (globe style)
- 3/4" inlet and outlet
- Temperature gauge (optional, stainless steel)
- Stainless steel hose rack
- Mounting plate and hardware for wall mounting

**Specifications**

- Maximum operating pressure: **150 PSI**
- Maximum temperature: **200°F (93°C)**

---

**304 Stainless Steel Part #**

WDS0-SS

H

## Thermal-Gard™ Elevated Temperature Spray Nozzle

### Features

- Thermal-Gard™ elevated temperature spray nozzle protects the operator from extreme hot water temperatures that exceed the comfort zone of standard hot water nozzles
- Assembly includes required special rigid, stainless steel adapter, (3/8" male NPT x 1/2" female NPT)
- Thermal insulating sleeve reduces overall heat during elevated temperature conditions.
- Stainless steel lever handle is coated for additional thermal protection and operator comfort
- Lightweight aluminum alloy body reduces overall weight
- Aluminum alloy body is electroless nickel plated for additional corrosion protection
- 3/8" female NPT inlet
- Black cover
- See pages 409 - 411 for washdown hose



### Specifications

- Recommended for water temperatures above 140°F (60°C) to a maximum temperature of 200°F (93°C)
- 12.5 GPM flow capacity
- Working pressure: 150 PSI

Aluminum  
Part #

AWSG-TG

H

## Swivel Connectors for Washdown Spray Guns

### Ball Type Swivel x Hose Shank

### Features

- Swivel connector for stainless spray nozzles
- 360° ball type swivel adapter helps prevent hose kinking

NPT	Hose I.D.	Brass Part #	300 Stainless Steel Part #
1/2"	1/2"	---	SSA44
	5/8"	---	SSA54
	3/4"	---	SSA64
3/8"	1/2"	BSA34	---

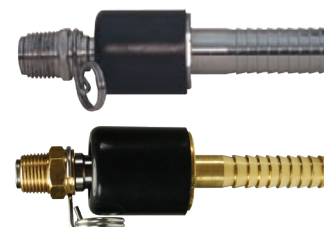

### Straight Swivel x Hose Shank

### Features

- Swivel body
- Gasket: EPDM

NPT	Hose I.D.	Brass Part #	Stainless Steel Part #
1/2"	1/2"	BNS44	BNS44SS
	3/4"	BNS64	BNS64SS



### Straight Swivel x GHT Thread

NPT	Female GHT	Brass Part #
1/2"	3/4"	BMAS974



### Hot Water Washdown Spray Nozzles

**Application**

- For low pressure cleaning, tank and drum cleaning, and chemical manufacturing

**Features**

- Designed for operator comfort
- Variable spray pattern from conical spray to solid stream
- Hose connects at base of gun for easy maneuvering
- 1/2" female NPT inlet
- Do not use with steam lines 

**Specifications**

- Rubber coated handle protects hands from water temperatures to **150°F (66°C)**
- **12.5 GPM** flow capacity at **150 PSI**



Cover Color	Brass Part #	Aluminum Part #
black	BWSG	AWSG
white	BWSG-W	AWSG-W

### Lite Washdown Spray Nozzles

**Application**

- For use where reduced size and / or flow rate is preferred

**Features**

- More compact and lighter than standard nozzle
- Special formulated rubber cover for durability and easy replacement
- 3/8" female NPT inlet

**Specifications**

- **9.0 GPM** flow capacity at **100 PSI**
- Pressure rating: **150 PSI**
- Temperature rating **200°F (93°C)**



LWSG-W



LWSG-B

Cover Color	Brass Part #
blue	LWSG-B
white	LWSG-W

H

### Mini Spray Nozzle

**Features**

- 1/2" female NPT inlet
- Not for use with steam
- Designed as an industrial lightweight nozzle with heavyweight performance
- Durable dark blue cover protects user from hot surfaces produced by high temperature wash down applications
- Reduces hand fatigue and provides smooth lever action
- Variable spray patterns from fan spray to solid stream
- Drip-free automatic shutoff feature



**Specifications**

- Pressure rating **150 PSI** at **200°F (93°C)**
- Flow: **9.6 GPM** at 100 PSIG

**Stainless Steel**  
**Part #**

DM150SDB

### Spray Nozzle

**Features**

- 1/2" female NPT inlet
- Designed to prevent accidental spray
- Durable dark blue cover prevents front-mounted lever from being accidentally activated if nozzle is dropped
- Reduces hand fatigue and provides smooth lever action
- Trigger locking mechanism provides safe and secure method of keeping the nozzle open during any spray pattern
- Variable spray patterns from fan spray to solid stream
- Drip-free automatic shut-off feature
- Can be used with D150S-WAND



**Specifications**

- Rated to **150 PSI** at **200°F (93°C)**
- **9.6 GPM** flow capacity at 100 PSIG

**Stainless Steel**  
**Part #**

D150SDB

### Washdown Wand

**Features**

- Designed to provide user with a means of reaching desired washdown locations previously deemed unreachable by extending the nozzle by 3'
- Adjustable spray tip can be changed from fan to solid spray by twisting the tip until the desired flow pattern is achieved
- Quick disconnect feature allows user to quickly connect wand to the nozzles above
- Designed to only fit the D150SDB nozzle
- Wand is not for use with steam



**Specification**

- Minimum pressure is **75 PSI**

**300 Series Stainless Steel**  
**Part #**

D150S-WAND



### Temperature Indicating Spray Nozzle

**Features**

- Easy-to-read dial thermometer at rear of the nozzle provides accurate and continual monitoring of water temperature
- Plastic sight window
- Gauge assembly is recessed into the rubber cover for complete protection
- Alerts the operator to shut-down the steam valve upon cold water failure, preventing scalding and steam burn injuries ensuring operator safety
- Ensures a more accurate discharge water temperature reading
- 1/2" female NPT inlet
- Black cover

**Specifications**

- Recommended for water temperatures to **200°F (93°C)**
- Maximum operating pressure: **150 PSI**
- **12.5 GPM** flow capacity



**Bronze**  
**Part #**

BWSG-TI

H

### Stainless Steel Industrial Grade Spray Nozzle

**Application**

- Recommended for use in corrosive applications where bronze and aluminum nozzles are not suitable

**Features**

- Heavy duty 300 series stainless steel body and barrel
- Variable spray pattern adjusts from a soft spray to a solid stream
- Replaceable rubber cover is specially formulated to resist a wide range of oils and chemicals and protect surrounding equipment
- 1/2" female NPT inlet

**Specifications**

- Maximum operating pressure: **150 PSI**
- Maximum flow: **12.5 GPM at 150 PSI**
- Maximum temperature: **200°F (93°C)**



**300 Stainless Steel**  
**Part #**

300SSSG

### Brass Industrial Grade Front Lever Spray Nozzle

**Features**

- Provides effortless one hand operation; by actuating the operating lever the valve is opened/closed and the jet power is regulated from spray to concentrated jet
- Adjusting screw on back of gun allows you to fix the desired form of jet, fixing clamp for the operating lever allows lockable position for service
- 1/2" female NPT inlet
- Durable blue rubber cover

**Specifications**

- Maximum operating pressure: **350 PSI**
- Suitable for hot water up to **122°F (50°C)**
- Flow: **6.6 GPM at 72 PSI**



**Brass**  
**Part #**

DWG050



## E-Series Hydraulic Couplings

### Features

- Couplers have no internal valves, which provide maximum flow with minimum pressure drop
- Contact Dixon® for additional seal material options, pressure ratings, and other technical information
- Interchanges with Parker ST, Hannifin SST/BST, Foster FST, Hansen ST, and Tomco ST couplings
- Do not disconnect with pressure in line 

### Specification

- Nitrile rubber seals are standard, providing a temperature range of -40°F to 250°F (-40°C to 121°C)

### Straight-Through Female Threaded Couplers

Body Size	Threads	Brass		303 Stainless Steel	
		Previous Part #	Part #	Previous Part #	Part #
1/8"	1/8" - 27 NPTF	---	1EF1-B	---	1EF1-S
1/4"	1/4" - 18 NPTF	STFC2	2EF2-B	STFC2SS	2EF2-S
	1/4" - 19 BSPP	---	2EBF2-B	---	---
3/8"	3/8" - 18 NPTF	STFC3	3EF3-B	STFC3SS	3EF3-S
	3/8" - 19 BSPP	---	3EBF3-B	---	---
1/2"	1/2" - 14 NPTF	STFC4	4EF4-B	STFC4SS	4EF4-S
	1/2" - 14 BSPP	---	4EBF4-B	---	---
3/4"	3/4" - 14 NPTF	STFC6	6EF6-B	STFC6SS	6EF6-S
	3/4" - 14 BSPP	---	6EBF6-B	---	---
1"	1" - 11-1/2 NPTF	STFC8	8EF8-B	STFC8SS	8EF8-S
	1" - 11 BSPP	---	8EBF8-B	---	---
1-1/4"	1-1/4" - 11-1/2 NPTF	STFC10	10EF10-B	---	10EF10-S
1-1/2"	1-1/2" - 11-1/2 NPTF	STFC12	12EF12-B	---	12EF12-S
2"	2" - 11-1/2 NPTF	STFC16	16EF16-B	---	16EF16-S



brass



303 stainless

H

### Straight-Through Male Threaded Couplers

Body Size	Threads	Brass		303 Stainless Steel	
		Previous Part #	Part #	Previous Part #	Part #
1/8"	1/8" - 27 NPTF	---	1EM1-B	---	1EM1-S
1/4"	1/4" - 18 NPTF	STMC2	2EM2-B	STMC2SS	2EM2-S
3/8"	3/8" - 18 NPTF	STMC3	3EM3-B	STMC3SS	3EM3-S
1/2"	1/2" - 14 NPTF	STMC4	4EM4-B	STMC4SS	4EM4-S
3/4"	3/4" - 14 NPTF	STMC6	6EM6-B	STMC6SS	6EM6-S
1"	1" - 11-1/2 NPTF	STMC8	8EM8-B	STMC8SS	8EM8-S
1-1/4"	1-1/4" - 11-1/2 NPTF	STMC10	10EM10-B	---	---
1-1/2"	1-1/2" - 11-1/2 NPTF	STMC12	12EM12-B	---	---
2"	2" - 11-1/2 NPTF	STMC16	16EM16-B	---	---



brass



303 stainless

### Straight-Through Hose Barb Couplers

Body Size	Hose I.D.	Brass Part #
1/4"	1/4"	2ES2-B
3/8"	3/8"	3ES3-B
1/2"	1/2"	4ES4-B
3/4"	3/4"	6ES6-B
1"	1"	8ES8-B



### E-Series Hydraulic Couplings

#### Straight-Through Female Threaded Plugs

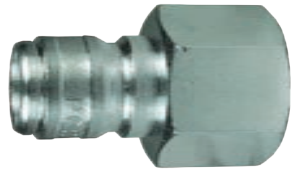

steel



brass

Body Size	Threads	Steel		Brass	
		Previous Part #	Part #	Previous Part #	Part #
1/8"	1/8" - 27 NPTF	---	E1F1	---	E1F1-B
1/4"	1/4" - 18 NPTF	STFP2	E2F2	STFP2B	E2F2-B
	1/4" - 19 BSPP	---	---	---	E2BF2-B
3/8"	3/8" - 18 NPTF	STFP3	E3F3	STFP3B	E3F3-B
	3/8" - 19 BSPP	---	---	---	E3BF3-B
1/2"	1/2" - 14 NPTF	STFP4	E4F4	STFP4B	E4F4-B
	1/2" - 14 BSPP	---	---	---	E4BF4-B
3/4"	3/4" - 14 NPTF	---	E6F6	---	E6F6-B
	3/4" - 14 BSPP	---	---	---	E6BF6-B
1"	1" - 11-1/2 NPTF	STFP8	E8F8	STFP8B	E8F8-B
	1" - 11 BSPP	---	---	---	E8BF8-B
1-1/4"	1-1/4" - 11-1/2 NPTF	STFP10	E10F10	---	E10F10-B
1-1/2"	1-1/2" - 11-1/2 NPTF	STFP12	E12F12	---	E12F12-B
2"	2" - 11-1/2 NPTF	STFP16	E16F16	---	E16F16-B

H



Body Size	Threads	303 Stainless Steel	
		Previous Part #	Part #
1/8"	1/8" - 27 NPTF	---	E1F1-S
1/4"	1/4" - 18 NPTF	STFP2SS	E2F2-S
3/8"	3/8" - 18 NPTF	STFP3SS	E3F3-S
1/2"	1/2" - 14 NPTF	STFP4SS	E4F4-S
3/4"	3/4" - 14 NPTF	---	E6F6-S
1"	1" - 11-1/2 NPTF	STFP8SS	E8F8-S
1-1/4"	1-1/4" - 11-1/2 NPTF	---	E10F10-S
1-1/2"	1-1/2" - 11-1/2 NPTF	---	E12F12-S
2"	2" - 11-1/2 NPTF	---	E16F16-S

#### Straight-Through Male Threaded Plugs



steel



brass

Body Size	Threads	Steel		Brass	
		Previous Part #	Part #	Previous Part #	Part #
1/8"	1/8" - 27 NPTF	---	E1M1	---	E1M1-B
1/4"	1/4" - 18 NPTF	STMP2	E2M2	STMP2B	E2M2-B
3/8"	3/8" - 18 NPTF	STMP3	E3M3	STMP3B	E3M3-B
1/2"	1/2" - 14 NPTF	STMP4	E4M4	STMP4B	E4M4-B
3/4"	3/4" - 14 NPTF	STMP6	E6M6	STMP6B	E6M6-B
1"	1" - 11-1/2 NPTF	STMP8	E8M8	STMP8B	E8M8-B
1-1/4"	1-1/4" - 11-1/2 NPTF	STMP10	E10M10	---	E10M10-B
1-1/2"	1-1/2" - 11-1/2 NPTF	STMP12	E12M12	---	E12M12-B
2"	2" - 11-1/2 NPTF	STMP16	E16M16	---	E16M16-B



Body Size	Threads	303 Stainless Steel	
		Previous Part #	Part #
1/8"	1/8" - 27 NPTF	---	E1M1-S
1/4"	1/4" - 18 NPTF	STMP2SS	E2M2-S
3/8"	3/8" - 18 NPTF	STMP3SS	E3M3-S
1/2"	1/2" - 14 NPTF	STMP4SS	E4M4-S
3/4"	3/4" - 14 NPTF	STMP6SS	E6M6-S
1"	1" - 11-1/2 NPTF	STMP8SS	E8M8-S

## E-Series Hydraulic Couplings

### Straight-Through Hose Barb Plugs

Body Size	Hose I.D.	Steel Part #	Brass Part #
1/4"	1/4"	E2S2	E2S2-B
3/8"	3/8"	E3S3	E3S3-B
1/2"	1/2"	E4S4	E4S4-B
3/4"	3/4"	E6S6	E6S6-B
1"	1"	E8S8	E8S8-B



steel



brass

### Straight-Through Coupler Seal Kits

Body Size	Coupler Style	Seal Kit Contents	Nitrile Part #	FKM Part #	EPDM Part #
1/4"	all	body O-ring	2E-SKIT	F-2E-SKIT	P-2E-SKIT
3/8"	all	body O-ring	3E-SKIT	F-3E-SKIT	P-3E-SKIT
1/2"	all	body O-ring	4E-SKIT	F-4E-SKIT	P-4E-SKIT
3/4"	all	body O-ring	6E-SKIT	F-6E-SKIT	P-6E-SKIT
1"	all	body O-ring	8E-SKIT	F-8E-SKIT	P-8E-SKIT
1-1/4"	all	body O-ring	10E-SKIT	F-10E-SKIT	P-10E-SKIT
1-1/2"	all	body O-ring	12E-SKIT	F-12E-SKIT	P-12E-SKIT
2"	all	body O-ring	16E-SKIT	F-16E-SKIT	P-16E-SKIT

H

### Plug Profiles

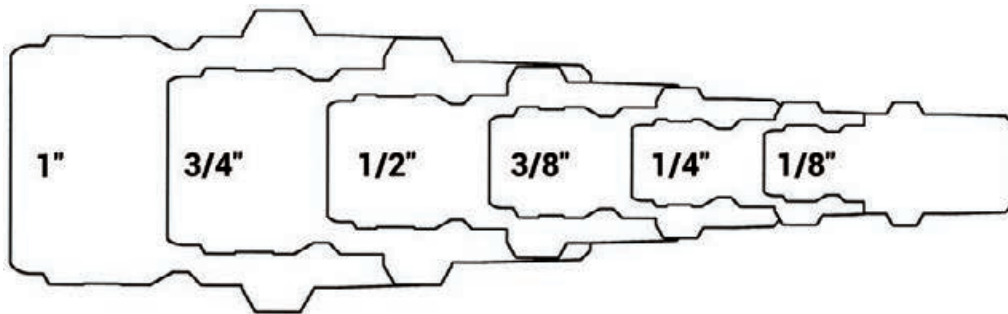

### Industry/Competitor Interchange

Foster FST  
Parker ST  
Hansen ST

**Spray Guns**  
**Anti-Fatigue Spray Gun**



**Features**

- 3/8" female inlet
- 1/4" female outlet
- Anti-fatigue pressure compensating design

**Specification**

- Temperatures to: 320°F (160°C)

Maximum PSI	GPM	Part #
5075	12.0	HPSG
5000	10.6	HPSGW <sup>1</sup>

<sup>1</sup> W = weeping, for the car wash industry, allows a small stream of water / leak

**Pressure Spray Gun**



**Features**

- 3/8" female inlet
- 1/4" female outlet

**Specifications**

- Working pressure: 4500 PSI
- Maximum temperature: 320°F (160°C)

GPM	Part #
8	HPSGL

**Heavy Duty Anti-Fatigue Spray Gun**



**Features**

- 3/8" female inlet
- 1/4" female outlet
- Heavy duty anti-fatigue design
- Stainless inner tube
- Zytel® housing

**Specifications**

- Working pressure: 5800 PSI
- Maximum temperature: 320°F (160°C)

GPM	Part #
8	HPSGHD

**Pressure Spray Gun with Extension**



**Features**

- 3/8" female inlet
- 22 mm x 1.5 mm female outlet
- Extension length: 19"

**Specifications**

- Working pressure: 3700 PSI
- Maximum temperature: 140°F (60°C)

GPM	Part #
8	AL9

**Pressure Spray Gun Kit with Hose, Nozzle & Lance**



**Features**

- Lance: 18" with vari-spray nozzle 1.25 mm with 22 mm male inlet
- Hose: 25', 1/4" I.D. with 22 mm x 14 mm female ends
- Nozzle: 4.0 variable nozzle 0° to 80°

**Specification**

- Gun: 22 mm male inlet, 22 mm x 1.5 mm female outlet end, working pressure 2500 PSI

Part #
BIT-KIT

H

## Spray Lances and Extensions for Pressure Gun

### Spray Lance

**Feature**

- For use with AL9 spray gun only on page 402

**Specifications**

- Maximum operating pressure: **5000 PSI**
- Maximum temperature: **300°F (149°C)**



Length	Description	Zinc Part #
24"	22 mm x 1.4 mm male inlet x 1/4" male outlet	AL248

### Dual Spray Lances

**Features**

- For use with HPSG, HPSGC, HPSGHD, and HPSGW
- For soap and water
- Requires (1) high pressure nozzle and (1) soap nozzle on page 406
- Allows quick adjustment from high to low pressure with a twist of the handle; low pressure setting allows for use of soap

**Specifications**

- Maximum temperature: **300°F (149°C)**
- **10.5 GPM**



AL333



AL344

Length	Description	Maximum Operating PSI	Part #
40"	zinc, 1/4" male inlet (2) each 1/4" female outlets	<b>3,650</b>	AL333
	stainless steel, 1/4" male inlet, (2) each 1/4" female outlets	<b>4,000</b>	AL344

### Molded Grip Extensions

**Feature**

- For use with HPSG, HPSGC, HPSGHD, and HPSGW

**Specifications**

- Maximum operating pressure: **5000 PSI**
- Temperature: **302°F (150°C)**
- **10.5 GPM** maximum



AL323

AL324

AL325 & AL326

Length	Description	Zinc Part #
24"	1/4" male inlet x 1/4" male outlet	AL323XX
36"	1/4" male inlet x 1/4" male outlet, 4" space from the end	AL324XX
48"	1/4" male inlet x 1/4" male outlet, 2 grips	AL325XX
59"	1/4" male inlet x 1/4" male outlet, 2 grips	AL326XX

### Vented Grip Lances

**Features**

- For use with HPSG, HPSGC, HPSGHD, and HPSGW
- For hot water

**Specifications**

- Maximum operating pressure: **5000 PSI**
- Maximum temperature: **300°F (149°C)**
- **10.5 GPM** maximum



AL361



AL362

Length	Description	Zinc Part #
36"	1/4" male inlet x 1/4" female outlet, straight	AL361
48"	1/4" male inlet x 1/4" female outlet, bent	AL362

### Telescoping Lance and Belt for Pressure Gun



**Features**

- 3/8" female (pipe thread) inlet
- 1/4" female (quick connect) outlet
- Length is in three sections
- 1/4" steel braided hose

**Specifications**

- Maximum operating pressure: **4000 PSI**
- **7 GPM**
- Maximum temperature: **300°F (149°C)**

Length	Aluminum Part #
6' - 18'	ARTEL18A

### Telescoping Lance Belt

**Feature**

- Adjusts to fit a 33" to 58" waist

Nylon Part #
ARTEL-BELT

### Swiveling Quick Couplings

**Specifications**

- Working pressure: **3650 PSI**
- **7.8 GPM**
- Maximum temperature: **300°F (149°C)**

#### 1/4" swiveling quick couplings



Description	Part #
1/4" female x 22 mm x 1.5 mm swivel	AL450 <sup>1</sup>

<sup>1</sup> For use with AL456 only



Description	Part #
1/4" male x 22 mm x 1.5 mm swivel	AL451 <sup>2</sup>

<sup>2</sup> For use with AL464 only

#### 3/8" swiveling quick couplings



Description	Part #
3/8" female x 22 mm x 1.5 mm swivel	AL453 <sup>1</sup>

<sup>1</sup> For use with AL456 only



Description	Part #
3/8" female inlet x 1/2" female outlet swivel	AL462 <sup>2</sup>

<sup>2</sup> For use with AL464 only

H

### Fixed Plugs

**Specifications**

- Working pressure: **3650 PSI**
- **7.8 GPM**
- Maximum temperature: **300°F (149°C)**

#### 1/4" fixed quick coupling plugs

Description	Part #
1/4" female x 22 mm x 1.5 mm male	AL454 <sup>1</sup>

<sup>1</sup> For use with AL453 and AL9

Description	Part #
1/4" male x 22 mm x 1.5 mm male	AL455F <sup>2</sup>

<sup>2</sup> For use with AL462 only

#### 3/8" fixed quick coupling plugs

Description	Part #
3/8" female x 22 mm x 1.5 mm male	AL456 <sup>1</sup>

<sup>1</sup> For use with AL453 and AL9

Description	Nickel Plated Brass Part #
3/8" female x 1/2" male plug	AL464 <sup>2</sup>

<sup>2</sup> For use with AL462 only



### Sewer Nozzles

**Specifications**

- Working pressure: **3625 PSI**
- Maximum temperature: **300°F (149°C)**

Size	Orifice	303 Stainless Steel Part #
3/8"	4.5 mm	SWNZ380-045
	5 mm	SWNZ380-050



### Injector Nozzles

**Features**

- Designed to inject cleaning solutions into high pressure discharge lines
- 3/8" male inlet and outlet

**Specification**

- Maximum working pressure: **4500 PSI**

Description	Orifice	Flow (GPM)	Part #
adjustable	1.8 mm	<b>2 - 8</b>	AL472
adjustable	2.1 mm	<b>3 - 8</b>	AL477
adjustable	2.3 mm	<b>4 - 8</b>	AL478



AL477

### Line Strainer

**Features**

- 1/2" female inlet, 1/2" male outlet
- .60 mesh cuffed filter
- 2 additional 1/4" side ports

**Specifications**

- Working pressure: **100 PSI**
- **8 GPM** maximum



**Aluminum Part #**

AR3000-A2

### High Pressure Spray Soap Nozzles



Description	Brass Part #
1/4" male inlet, 40° spray angle, size #40	NZ4040S
1/4" male inlet, 80° spray angle, size #40	NZ8040S

### High Pressure Spray Nozzles



Description	Steel Part #
1/4" male NPT inlet, 15° spray angle, size 4	NZ1504
1/4" male NPT inlet, 25° spray angle, size 4	NZ2504
1/4" male NPT inlet, 40° spray angle, size 4	NZ4004

### Quick Connect Soap Nozzle



Description	Brass Part #
1/4" straight-through plug inlet, 65° spray angle, size #40	NZ6540QCS

NOTE: Use with 1/4" couplers on page 498

### Quick Connect Spray Nozzles



Description	Part #
1/4" straight-through plug inlet, 0° spray angle, size #4, red	MSP400
1/4" straight-through plug inlet, 15° spray angle, size #4, yellow	MSP415
1/4" straight-through plug inlet, 25° spray angle, size #4, green	MSP425
1/4" straight-through plug inlet, 40° spray angle, size #4, white	MSP440

NOTE: Use with 1/4" couplers on page 498

### Multi-Pack Quick Connect Nozzles



Description	Nozzles Included	Part #
1/4", 65° spray angle, size #40	NZ6540QCS	MSP4PAK
1/4", 15° spray angle, size #4, yellow	MSP415	
1/4", 25° spray angle, size #4, green	MSP425	
1/4", 40° spray angle, size #4, white	MSP440	

### Multi-Pack High Pressure Spray Nozzles

**Features**

- 1/4" quick connect nozzle multi-packs include: 0° red, 15° yellow, 25° green, 40° white and 50° black soap nozzles
- 1/4" MEG nozzle multi-packs include: 0°, 15°, 25°, 40°, and 65° soap nozzles



Nozzle Size	GPM @ PSI									Part #
	800	1000	1500	2000	2500	3000	3500	4000	5000	
3.0	1.34	1.50	1.84	2.12	2.37	2.60	2.81	3.00	3.35	NZMQC5P-030
3.5	1.57	1.75	2.14	2.47	2.77	3.03	3.27	3.50	3.91	NZMQC5P-035
4.0	1.79	2.00	2.45	2.83	3.16	3.46	3.74	4.00	4.47	NZMQC5P-040
4.5	2.01	2.25	2.76	3.18	3.56	3.90	4.21	4.50	5.03	NZMQC5P-045
5.0	2.24	2.50	3.06	3.54	3.95	4.33	4.68	5.00	5.59	NZMQC5P-050
5.5	2.46	2.75	3.37	3.89	4.35	4.76	5.14	5.50	6.15	NZMQC5P-055
6.5	2.91	3.25	3.98	4.60	5.14	5.63	6.08	6.50	7.27	NZMQC5P-065
8.0	3.58	4.00	4.90	5.66	6.32	6.93	7.48	8.00	8.94	NZMQC5P-080



Nozzle Size	GPM @ PSI									Part #
	800	1000	1500	2000	2500	3000	3500	4000	5000	
3.5	1.57	1.75	2.14	2.47	2.77	3.03	3.27	3.50	3.91	NZMMEG5P-035
4.0	1.79	2.00	2.45	2.83	3.16	3.46	3.74	4.0	4.47	NZMMEG5P-040
4.5	2.01	2.25	2.76	3.18	3.56	3.90	4.21	4.50	5.03	NZMMEG5P-045
5.0	2.24	2.50	3.06	3.54	3.95	4.33	4.68	5.00	5.59	NZMMEG5P-050
5.5	2.46	2.75	3.37	3.89	4.35	4.76	5.14	5.50	6.15	NZMMEG5P-055



### Spray Nozzle Selection Guidelines

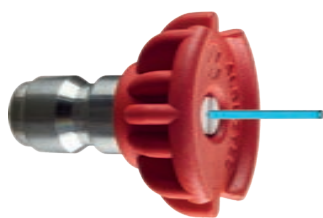

**0°  
Blasting Nozzle**

- Removing caked on mud from heavy construction, farm or lawn equipment.
- Cleaning tar, glue, or stubborn stains from concrete
- Cleaning overhead areas
- Removing rust from steel and oxidation from aluminum

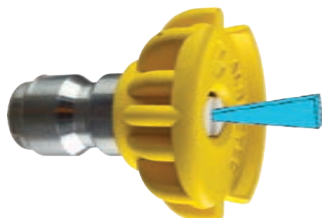

**15°  
Stripping Nozzle**

- Removing paint from wood, masonry or metal
- Removing grease or dirt from equipment
- Removing heavy mildew stains
- Removing marine growth from boats and marine equipment
- Removing rust from steel and oxidation from aluminum



**25°  
Cleaning Nozzle**

- General cleaning of dirt, mud and grime
- Cleaning roofs, gutters, and downspouts
- Removing light mildew stains
- Removing algae and bacteria build-up from pools
- Rinsing surfaces in preparation for painting

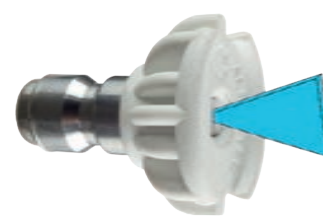

**40°  
Washing Nozzle**

- Light cleaning and washing
- Washing and rinsing of automobiles and boats
- Cleaning roofs, windows, patios, and driveways



Caution: The spray force from these nozzles can cause injuries if pointed directly at yourself or others. Before observing directly always disconnect from spray wand. Make sure spray nozzle is properly locked in place with its quick coupler. If the collar is not in the locking position, the nozzle will become a dangerous projectile. The O-ring from your quick coupler socket will also be blown out of place.

### Nozzle Spray Chart

Nozzle Orifice Size	Gallons per Minute	1000 PSI	1200 PSI	1250 PSI	1300 PSI	1500 PSI	1800 PSI	2000 PSI	2100 PSI	2200 PSI	2300 PSI	2400 PSI	2500 PSI	3000 PSI	3200 PSI	3500 PSI	4000 PSI	5000 PSI
		3.0	1.50	1.64	1.68	1.71	1.84	2.01	2.12	2.17	2.22	2.27	2.32	2.37	2.60	2.68	2.81	3.00
3.5	1.75	1.92	1.96	2.00	2.14	2.35	2.47	2.54	2.60	2.65	2.71	2.77	3.03	3.13	3.27	3.50	3.91	
4.0	2.00	2.19	2.24	2.28	2.45	2.68	2.83	2.90	2.97	3.03	3.10	3.16	3.46	3.58	3.74	4.00	4.47	
4.5	2.25	2.46	2.52	2.57	2.76	3.02	3.18	3.26	3.34	3.41	3.49	3.56	3.90	4.02	4.21	4.50	5.03	
5.0	2.50	2.74	2.80	2.85	3.06	3.35	3.54	3.62	3.71	3.79	3.87	3.95	4.33	4.47	4.68	5.00	5.59	
5.5	2.75	3.01	3.07	3.14	3.37	3.69	3.89	3.99	4.08	4.17	4.26	4.35	4.76	4.92	5.14	5.50	6.15	
6.5	3.25	3.56	3.63	3.71	3.98	4.36	4.60	4.71	4.82	4.93	5.03	5.14	5.63	5.81	6.08	6.50	7.27	
8.0	4.00	4.38	4.47	4.56	4.90	5.37	5.66	5.80	5.93	6.07	6.20	6.32	6.93	7.16	7.48	8.00	8.94	

### Turbo Nozzles

**Features**

- 20° spray angle
- Ceramic orifice

**Specification**

- Maximum temperature: 212°F (100°C)



Nozzle Size	Description	Orifice	Maximum Working PSI	Part #
4.0	1/4" female inlet	1.30 mm	3,700	AL-TPR25-30
6.0	1/4" female inlet	1.50 mm	3,700	AL-TPR25-50
7.0	1/4" female inlet	1.70 mm	3,700	AL-TPR25-70
4.0	1/4" female inlet	1.30 mm	5,075	AL-TPR35-30
6	1/4" female inlet	1.50 mm	5,075	AL-TPR35-50
7	1/4" female inlet	1.70 mm	5,075	AL-TPR35-70

### Nozzle Holders

**Specification**

- Maximum temperature: 320°F (160°C)



AL414



AL416

Description	Flow (GPM)	Working PSI	Part #
adjustable hi/low nozzle holder with nozzle protector, 1/4" female inlet and outlet	8	3,650	AL414
change over nozzle, 1/4" female inlet, 2 each 1/4" female outlets	8	2,900	AL416

### Inlet Filter for Turbo Nozzles

**Features**

- 1/4" female inlet, 1/4" male outlet
- 100 mesh filter

**Specification**

- Maximum temperature: 212°F (100°C)



Description	Flow (GPM)	Working PSI	Part #
stainless steel, inlet water filter	8	5,000	AR3500

### Balance Release Valve

**Features**

- Inlet/outlet: 3/8" female NPT
- Bypass: 3/8" female NPT

**Specifications**

- Working PSI: 4,000 PSI
- Maximum temperature: 195°F (90.6°)
- GPM: 6.6



Brass  
Part #

AL702

### Water Broom

**Features**

- 1/4" quick connect plug

**Specification**

- Working PSI: 4,000 PSI



Description	Length	Stainless Steel Part #
4-nozzle broom	16"	AR-BROOM16

H

### Unloader Valves

**Features**

- Automatically relieves pressure from the pump at shut-off
- Inlet: (2) each, 3/8" female NPT
- Outlet: 3/8" female NPT
- Bypass: (2) each, 3/8" female NPT

**Specification**

- Maximum temperature: 190°F (88°C)

Description	Maximum Flow (GPM)	Working PSI	Part #
yellow spring	8	2,320	AL605
blue spring	8	3,650	AL606
black spring	8	4,500	AL607



**Features**

- Inlet: 3/8" female
- Outlet: 3/8" male
- Bypass: 3/8" female

**Specification**

- Maximum temperature: 190°F (88°C)

Description	Flow (GPM)	Working PSI	Part #
VR-35 unloader valve	9	5,100	AR20831



### Thermal Relief Valve

**Features**

- Inlet: 1/2" male

**Specifications**

- Operating PSI: 200 PSI
- Maximum temperature: 140°F (60°C)

Brass  
Part #

TPP140



### Safety Release Valve

**Features**

- Inlet: 3/8" male

**Specifications**

- Pressure range: 1,000 to 4,000 PSI
- Maximum temperature: 200°F (93°C)
- GPM: 6

Part #

AR5000-1



### Pressure Washer Braided Hose

**Specification**

- Maximum temperature: 250°F (121°C)

I.D.	Male Swivel Inlet	Male Swivel Outlet	Pressure Rating (PSI)	Length	Rubber Part #
3/8"	3/8"	3/8"	4,000	50'	AR503830SSP



### Hand Crank Hose Reel

**Features**

- 3/8" outlet, 3/8" inlet
- Includes jumper hose, mounting bracket and crank handle
- Holds 100' of 3/8" pressure hose

**Specifications**

- Working PSI: 3,000 PSI
- Maximum temperature: 160°F (71°C)

Steel  
Part #

AR-REEL100



### Contractors EPDM Water Hose



**Features**

- Heavy-duty, crush-proof solid brass couplings with wrench grips
- Spiral synthetic cord reinforcement
- Black cover

**Specifications**

- Working pressure: **150 PSI**
- Temperature range: **-20°F to 180°F (-29°C to 82°C)**

Size	EPDM Part #	Optional Qty
3/4" x 50'	CWH50	3

### Rubber Vinyl Garden Hose

H



**Features**

- Extra tough, five-ply construction
- Exclusive, soft textured, abrasion-resistant green cover
- Dual reinforced, heavy-duty, flexibility, kink resistance
- Combines durability of rubber, easy handling of vinyl
- SEAL-TITE® leakproof coupling

**Specifications**

- Working pressure: **400 PSI**
- Temperature range: **0°F to 140°F (-18°C to 60°C)**

Size	Rubber Vinyl Part #	Optional Qty
5/8" x 25'	SGH25	5
5/8" x 50'	SGH50	5
5/8" x 75'	SGH75	3
5/8" x 100'	SGH100	3

### Premium EPDM Hose



**Features**

- Professional grade reinforcement provides maximum strength
- Heavy-duty flexibility
- Ultimate kink resistance
- SEAL-TITE® leakproof coupling
- Lead-free drinking water safe
- 40% lighter than standard rubber hose
- Black cover

**Specifications**

- Working pressure: **400 PSI**
- Temperature range: **-40°F to 165°F (-40°C to 74°C)**

Size	EPDM Part #	Optional Qty
5/8" x 50'	PGH50	4
5/8" x 100'	PGH100	4

### Flexogen® Hose



**Features**

- Heavy-duty, crush-resistant, full-flow brass couplings with a built-in washer for tight sealing
- Coils and handles easily in all weather
- Lightweight patented 8-ply construction
- Maximum kink resistance
- Flow guard plus protective collar resists kinks at faucet
- Polished surface resists abrasions, stains, and mildew
- Grey cover

Size	Flexogen® Part #
5/8" x 25'	FGH25
5/8" x 50'	FGH50

### Top Level PVC Hose

**Features**

- Heavy-duty 3/4" brass couplings
- Kink resistant
- Green cover

**Specifications**

- Working pressure: **100 PSI**
- Temperature range: **15°F to 150°F (-9°C to 66°C)**

Size	PVC Part #
5/8" x 75'	GGH75



### Hot Water Rubber Reinforced Hose

**Features**

- Industrial style reinforcing for flexibility, high burst strength
- Extra heavy-duty, crush-proof, machined brass couplings
- Maximum wear, abrasion-resistant red cover
- Lead-free drinking water safe
- 40% lighter than standard rubber hose

**Specifications**

- Withstands extensive hot water up to **-40°F to 165°F (-40°C to 74°F)**
- Working pressure: **400 PSI**

Size	Rubber Part #	Optional Qty
5/8" x 50'	HWH50	4
3/4" x 50'	HWH50-75	4



### Marine, Camper, Patio & Pool Hose

**Features**

- Lightweight to handle, easy to store
- USFDA - approved tube materials for food contact use
- Nickel plated couplings
- Lead-free drinking water safe
- White cover

**Specification**

- Working pressure: **300 PSI** at ambient temperature **70°F (21°C)**

Size	Part #	Optional Qty
5/8" x 50'	MCH50	5



### Hot Water Washdown Hose

**Features**

- Smooth extruded chlorobutyl tube
- White, wrapped Hypalon cover (.075" thick) with braided textile reinforcement
- Furnished with internal stainless steel spring guards at both ends
- 3/4" male on one end and 1/2" male on the other

**Specifications**

- Working pressure: **250 PSI**
- Maximum temperature: **200°F (93°C)**

Hose I.D. x Length	Part #
5/8" x 25'	SWDSHOSE25
5/8" x 50'	SWDSHOSE50



### Fog Nozzles

**Features**

- Shutoff - straight stream - fog
- Brass stem
- Standard flow

**Specifications**

- Maximum operating pressure: **100 PSI** (water only) at 70°F (21°C)
- 120° spray **GPM @100 PSI**



Size	Thread	90° Spray GPM @ 100 PSI	Polycarbonate Part #
3/4"	GHT	8.0	FNB75GHT

### Hydrant Adapters - Pin Lug



Female Thread	Male Thread	Cast Brass Part #
2-1/2" NST (NH)	3/4" GHT	HA2576

### Black SBR Washers



I.D.	O.D.	Duro	Part #	Optional Qty
0.63"	1.00"	80	5911212W	100
0.86"	1.27"	60	5911616W	100

### Black EPDM Garden Hose Washer



Description	I.D.	O.D.	Duro	Part #
black peroxide cure EPDM NSF®	0.63"	1.00"	70	5911212WEPDM
	0.86"	1.27"	70	5911616WEPDM

### Garden Hose Filter Washer



Description	FDA black 70a duro PVC		Optional Qty
	Previous Part #	Part #	
304 stainless steel mesh, FDA black 70a duro PVC	TVS7-30	5911212F	100

### Red Vinyl GHT Washer



Red Vinyl Part #	Optional Qty
TVW7	100

### White Rubber GHT Washer



White Rubber (Styrene Butadiene) Part #	Optional Qty
TRW7	100

H

### Sweeper Nozzle

Thread Size	Discharge	Length	Brass	
			Previous Part #	Part #
3/4" GHT	3/16"	2"	500SN2	PSN76



### Flexible Water Nozzle

**Feature**

- Bends for water flow, shuts off when released

Thread Size	Part #
3/4" GHT	8005



### Brass / Rubber Power Flow Water Nozzle

**Features**

- All metal body and handle
- Curved design to fit the contour of your hand
- Overmold for comfortable handling
- Built in flow control to regulate the amount of water flow
- Locking feature to make extended watering easy
- Large easy-turn dial

Thread Size	Part #
3/4" GHT	PNB75GHT



### Heavy Duty Hot Water Nozzle

**Features**

- Hot water rated
- ThermoGuard overmold protects hands from heat and remains comfortable even with heavy use
- Durable brass spray tip for added durability in extreme conditions
- Adjustable front tip alters spray from powerful jet to light rinse
- Flow control dial customizes force of the water stream

**Material**

- Heavy-duty die-cast zinc construction

Thread Size	Part #
3/4" GHT	PHDN75



### Insulated Water Nozzles

**Features**

- Clip locks to any spray pattern
- Industrial strength nylon handle
- Rubber handle guard
- GHT thread on head
- Heavy duty brass valve and adjusting nut

**Specifications**

- For use with hot water up to 140°F (60°C)

Thread Size	Chrome Plated Zinc Part #
3/4" GHT	SN75



### Pistol-Grip Water Nozzle

**Features**

- Clip locks to any spray pattern
- Easy squeeze on/off lever
- Brass valve and adjusting nut
- Stainless steel spring with lifetime packing
- Rubber handle guard

Thread Size	Zinc Metallized Part #
3/4" GHT	CSN75



### Twist Nozzles

**Specification**

- Maximum operating pressure 150 PSI (water only)

Thread Size	Length	Extruded Brass	
		Previous Part #	Part #
3/4" GHT	4"	---	BTN75
	4"	---	500AN4 <sup>1</sup>
	6-3/4"	500-AN7	500AN7 <sup>1</sup>



<sup>1</sup> Imported

### Adjust-A-Power Nozzle



**Features**

- Ideal for patio, auto and boat, driveway, and garden
- Produces 50% more power than twist nozzles
- Does not require a washer
- Leave nozzle in the open position when not in use
- Brass construction with stainless steel bearings

**Specifications**

- Maximum operating pressure: **100 PSI** (water only) at ambient temperature **70°F (21°C)**

Thread Size	Brass Part #
3/4" GHT	AAPN75GHT

### Constant Flow Nozzle Displays



FNB75GHT-GD

CNB75GHT-GD

**Features**

- Shatterproof and UV resistant polycarbonate withstands tough environmental conditions
- Seals used for true water shut off
- Easy twist spray pattern adjustment
- Sold in case quantity only (25 per case), with display

Thread	45° Spray GPM @ 100 PSI	Color	Global Part #
3/4" GHT	25.1	green	FNB75GHT-GD
	25.1	clear	CNB75GHT-GD

### Constant Flow Nozzles with Bumper



GNB75GHT



CNB75GHT

**Feature**

- Can be used as a replacement nozzle in the display case FNB75GHT-GD

Thread	45° Spray GPM @ 100 PSI	Color	Plastic Part #
3/4" GHT	8.0	green	GNB75GHT (domestic)
	25.1	clear	CNB75GHT (global)

### Plain Hose Nozzles



**Feature**

- Finish: satin

**Specification**

- Maximum operating pressure: **100 PSI** (water only) at **70°F (21°C)**

Size	Thread	Overall Length	Orifice	Replacement Gasket	Brass	
					Previous Part #	Part #
3/4"	GHT	6"	1/4"	KRW5	500SN6	BN6



### Compression Bibb Faucets

**Features**

- Rough brass finish
- Nozzle end is GHT
- For water use only

Male NPT Inlet Size	Brass Part #
1/2"	35-201-10
3/4"	35-202-10



### Garden Hose Quick Connects

**Features**

- Easy push-pull ring for long lasting and quick hose attachments

**Specifications**

- Maximum operating pressure: **150 PSI** at ambient temperature 70°F (21°C)
- Maximum temperature **140°F (60°C)**

#### Complete Assembly

Description	Brass		303 Stainless Steel	
	Previous Part #	Part #	Previous Part #	Part #
complete assembly	DGH7	500QCK	DGH7SS	500QCKSS
complete valved assembly	DGH7V	500QCKV	---	---



#### Female Couplers

Description	Brass		303 Stainless Steel	
	Previous Part #	Part #	Previous Part #	Part #
coupler	DGH7C	500QCF	DGH7CSS	500QCFSS
valved coupler-water shutoff	DGH7CV	500QCFV	---	---



#### Replacement Parts for 500QCFV

Description	Part #
replacement rubber seal gasket for 500QCFV (DGH7CV)	500QCFVSG
replacement NBR O-ring for 500QCFV (DGH7CV)	500QCFVOR



#### Replacement Seal for 500QCF

Nitrile Butadiene Rubber	
Previous Part #	Part #
DGHW7	500QCSG



#### Male Plugs

Description	Brass		303 Stainless Steel	
	Previous Part #	Part #	Previous Part #	Part #
male plug	DGH7P	500QCM	DGH7PSS	500QCMSS



### Straight GHT Valve

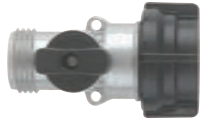

**Material**

- Powder-coated zinc shut-off valve

**Specifications**

- Maximum temperature: **160°F (71°C)** (hot water)
- Recommended usage: **100°F (38°C)**
- Working pressure: **60 PSI**

---

**Part #**

GHV

### GHT Ball Valve



**Material**

- Forged brass

**Specifications**

- Maximum temperature: **140°F (60°C)** (hot water)
- Working pressure: **100 PSI**

---

**Part #**

500GHV

### GHT Twin Valve



**Material**

- Powder-coated zinc with twin shut-off valves

**Specifications**

- Maximum temperature: **160°F (71°C)** (hot water)
- Recommended usage: **100°F (38°C)**
- Working pressure: **60 PSI**

---

**Part #**

GHYV

### Garden Hose Y Valve



**Feature**

- Double Y valve, swivel inlet - with Higbie cut threads (capped) to prevent cross threading

**Specifications**

- Maximum temperature: **140°F (60°C)** (hot water)
- Working pressure: **100 PSI**

**Material**

- Forged brass

---

**Part #**

500GHY

### Garden Hose Y Coupler



**Material**

- Nickel plated brass

**Specifications**

- Maximum working pressure: **100 PSI**
- Maximum temperature: **140°F (60°C)**

---

**Part #**

500YC

### GHT Y



**Feature**

- Includes one end cap

**Specifications**

- Maximum temperature: **160°F (71°C)** (hot water)
- Recommended usage: **100°F (38°C)**
- Working pressure: **60 PSI**

**Material**

- Powder-coated zinc with twin outlet

---

**Part #**

GHY

H

### GHT 4-Valve Manifold

**Features**

- Swivel inlet

**Materials**

- Forge brass body, TPR Handle, POM Internal valve, NBR seals

**Specifications**

- Maximum temperature: 120°F (49°C)
- Maximum operating pressure: 100 PSI



---

**Part #**

500GH4VBK

### GHT Back Flow Preventer

**Features**

- Manual drain
- Corrosion resistant

**Materials**

- Brass extruded stock
- Gasket: nitrile rubber
- Components: stainless steel

**Specifications**

- Maximum operating pressure: 125 PSI
- Temperature range: 33°F to 180°F (.5°C to 82°C)



---

**Part #**

500BFP

### Radiator Bibb

**Feature**

- 1/4" female pipe thread connection



---

**Vinyl Part #**

8013

### Garden Hose Gooseneck

**Features**

- Angles hose away from hose bibb

**Specifications**

- Recommended usage: 100°F (38°C)
- Working pressure: 60 PSI



---

**Powder Coated Zinc  
Part #**

GHGN

### GHT Zinc Fittings

**Features**

- Premium brass and zinc construction for maximum strength and durability
- Patented impact resistant clamp design
- Non-corroding high grade 410 stainless steel screws will not strip when tightened
- Leakproof, reusable
- For use with rubber or plastic hose
- Fits all 5/8" and 3/4" hose

**Female Hose Fitting**



Part #	Optional Qty
M5834F	48

**Male Hose Fitting**



Part #	Optional Qty
M5834M	48

**Mender**



Part #	Optional Qty
M5834HM	48

### Spray Valve and Hose Assembly

**Valves**

**Features**

- Even spray valve mist provides proper moisture on paper roll ends
- Helps eliminate wrinkles and folder delivery problems, increasing pressroom production and reducing waste
- A slight flex of the hose in any direction (360°) activates the spray
- Quick action with no protruding levers, thumb depressors, triggers or other devices utilized
- Positive water seal when hose is released causes the internal valve to close and immediately shut off spray
- Sealed mechanism with no packing gland



83304



83306H

Female NPT Size	Description	Part #
1/4"	valve only	83304
3/8"		83306
1/4"	valve with hook	83304H
3/8"		83306H

**Hose Assembly**



Male NPT Inlet	Description	Part #
3/8"	5' hose	8320605

NOTE: Additional hose lengths are available contact Dixon®

H

### Spray Hose Fittings Complete Couplings - GHT

Hose I.D.	GHT Thread	Plated Steel Part #
3/8"	3/4"	SS307
1/2"	3/4"	SS407
5/8"	3/4"	SS507
3/4"	3/4"	SS607



### Female Couplings - GHT

Hose I.D.	GHT Thread	Plated Steel Part #
3/8"	3/4"	SS347
1/2"	3/4"	SS447
5/8"	3/4"	SS547
3/4"	3/4"	SS647



### Male Couplings - GHT

Hose I.D.	GHT Thread	Plated Steel Part #
3/8"	3/4"	SS317
1/2"	3/4"	SS417
5/8"	3/4"	SS517
3/4"	3/4"	SS617



H

### Short Shank Couplings with Octagon Nut

Hose Size	Shank Length	Aluminum Part #
3/8"	13/16"	ABC73
3/4"	1-1/8"	ABC76



NOTE: Sold in complete sets only  
NOTE: Stock quantities only

### Standard Shank Cast Coupling with Hex Nut

**Features**

- Use with washers on page 377
- Sold in complete sets only

Hose Size	Brass Part #
1/2"	CBC74
5/8"	CBC75
3/4"	CBC76
1"	CBC88 <sup>1</sup>



<sup>1</sup> NPSM thread

### Garden Hose Menders

Hose I.D.	Brass	
	Previous Part #	Part #
1/2"	5780808C	1780808C
5/8"	5781010C	1781010C
3/4"	5781212C	1781212C
1"	5781616C	1781616C



NOTE: More sizes available on page 428

### Standard Shank Fittings

#### GHT Complete Couplings with Hex Nut

**Feature**

- Extended male GHT - deeper thread

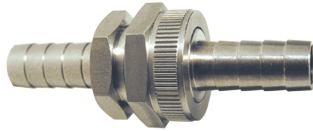

Hose Size	Brass		Lead-Free Brass <sup>2</sup> Part #	303 Stainless	
	Previous Part #	Part #		Previous Part #	Part #
3/8"	BC73	5920606K	---	---	---
1/2"	BC74	5920808K	5920808KLF	SSC74	5920808KSS
5/8"	BC75	5921010K	5921010KLF	SSC75	5921010KSS
3/4"	BC76	5921212K	5921212KLF	SSC76	5921212KSS
1"	BC78	5921612K	---	---	---
1"	BS808	5921616K <sup>1</sup>	---	---	---

<sup>1</sup> 1" NPSH thread

<sup>2</sup> NSF®/ANSI 61 certified lead-free brass <=0.25% lead, Alloy C2745 and NSF®/ANSI 61 certified 5911212WEPDM washer included

NOTE: Complete coupling set is not shipped assembled

#### GHT Female Fittings with Swivel Nut



Hose Size	Brass		Lead-Free Brass <sup>2</sup> Part #	303 Stainless		Pkg Qty
	Previous Part #	Part #		Previous Part #	Part #	
3/8"	BCF73	5910612C	---	---	---	25
1/2"	BCF74	5910812C	---	SSCF74	5910812SS	25
	---	---	5910812CLF	---	---	25
5/8"	BCF75	5911012C	---	SSCF75	5911012SS	25
	---	---	5911012CLF	---	---	25
3/4"	BCF76	5911212C	---	SSCF76	5911212SS	25
	---	---	5911212CLF	---	---	25
1"	BCF78	5911612C	---	---	---	10
	BS848	5911616C <sup>1,3</sup>	5911616CLF	---	---	10

<sup>1</sup> 1" NPSH thread

<sup>2</sup> NSF®/ANSI 61 certified lead-free brass <=0.25% lead, Alloy C2745 and NSF®/ANSI 61 certified 5911212WEPDM washer included

<sup>3</sup> Washer included, part # 5911616W on page 412

NOTE: SBR black rubber washer part # 5911212W included, found on page 412

#### GHT Male Fittings

**Feature**

- Extended male GHT - deeper thread



Hose Size	Brass		Lead-Free Brass <sup>2</sup> Part #	303 Stainless		Pkg Qty
	Previous Part #	Part #		Previous Part #	Part #	
3/8"	BCM73	5900612C	---	---	---	25
1/2"	BCM74	5900812C	---	SSCM74	5900812SS	25
	---	---	5900812CLF	---	---	25
5/8"	BCM75	5901012C	---	SSCM75	5901012SS	25
	---	---	5901012CLF	---	---	25
3/4"	BCM76	5901212C	---	SSCM76	5901212SS	25
	---	---	5901212CLF	---	---	25
1"	BCM78	5901612C	---	---	---	10
	BS818	5901616C <sup>1</sup>	5901616CLF	---	---	10

<sup>1</sup> 1" NPSH thread

<sup>2</sup> NSF®/ANSI 61 certified lead-free brass <=0.25% lead, Alloy C2745

H

## Short Shank Fittings

**Feature**

- Female couplings include 5911212W SBR washer; additional washers on page 412

### GHT Complete Couplings with Hex Nut

**Features**

- Extended male GHT - deeper thread
- Complete coupling set is not shipped assembled

Hose Size	Brass	
	Previous Part #	Part #
1/2"	HNBGH74	5890808K
5/8"	HNBGH75	5891010K
3/4"	HNBGH76	5891212K



### GHT Complete Couplings with Round Nut

Hose Size	Brass	
	Previous Part #	Part #
1/2"	BGH74	5870808K
5/8"	BGH75	5871010K
3/4"	BGH76	5871212K



H

### GHT Female Couplings with Round Nut

Hose Size	Shank Length	Brass	
		Previous Part #	Part #
1/2"	1"	BGHF74	5860812C
5/8"	1"	BGHF75	5861012C
3/4"	1"	BGHF76	5861212C



### GHT Female Swivels with Hex Nut

Hose Size	Shank Length	Brass	
		Previous Part #	Part #
1/2"	1"	HNBGHF74	5880812C
5/8"	1"	HNBGHF75	5881012C
3/4"	1"	HNBGHF76	5881212C



### GHT Male Couplings with Hex

**Feature**

- Extended male GHT - deeper thread

Hose Size	Shank Length	Brass	
		Previous Part #	Part #
1/2"	1"	BGHM74	5850812C
5/8"	1"	BGHM75	5851012C
3/4"	1"	BGHM76	5851212C



### Long Shank Fittings

#### Complete Couplings - GHT

**Features**

- Extended male GHT, deeper thread
- Brass female couplings include 5911212W washer; plated steel includes KRW5 washer



Hose I.D.	GHT Thread	Plated Steel Part #	Brass	
			Previous Part #	Part #
3/8"	3/4"	SLS307	---	---
1/2"	3/4"	SLS407	BLS407	5950808K
5/8"	3/4"	SLS507	BLS507	5951010K
3/4"	3/4"	SLS607	BLS607	5951212K

#### Female Couplings - GHT

**Feature**

- Brass female couplings include 5911212W washer; plated steel includes KRW5 washer

H

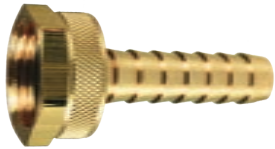

Hose I.D.	GHT Thread	Plated Steel Part #	Brass		Pkg Qty	Lead-Free Brass Part #
			Previous Part #	Part #		
3/8"	3/4"	SLS347	---	---	---	---
1/2"	3/4"	SLS447	BLS447	5940812C	25	---
5/8"	3/4"	SLS547	BLS547	5941012C	25	---
3/4"	3/4"	SLS647	BLS647	5941212C	25	5941212CLF <sup>1</sup>

#### Male Couplings - GHT

**Feature**

- Extended male GHT, deeper thread



Hose I.D.	GHT Thread	Plated Steel Part #	Brass		Pkg Qty	Lead-Free Brass Part #
			Previous Part #	Part #		
3/8"	3/4"	SLS317	---	---	50	---
1/2"	3/4"	SLS417	BLS417	5930812C	25	---
5/8"	3/4"	SLS517	BLS517	5931012C	25	---
3/4"	3/4"	SLS617	BLS617	5931212C	10	5931212CLF <sup>1</sup>

<sup>1</sup> NSF®/ANSI 61 certified lead-free brass <=0.25% lead, Alloy C2745 and NSF®/ANSI 61 certified 5911212WEPDM washer included with female coupling

#### Garden Hose Cap



Size	Brass		Optional Qty
	Previous Part #	Part #	
3/4"	GHC7	5131212C	25

#### Garden Hose Round Nut with Knurl



Size	Brass Part #
3/4"	5861012N

#### Garden Hose Hex Nut with Knurl



Size	Brass Part #	Lead-Free Brass <sup>1</sup> Part #
3/4" GHT	5911212N	5911212NLF
1" NPSH	5911616N	5911616NLF

<sup>1</sup> NSF®/ANSI 61 certified lead free brass <=0.25% lead, Alloy C2745



### Male GHT Adapters

**Feature**

- Extended male GHT, deeper thread

#### Male Hose x Male Hose x Female Pipe

Male GH x Male GH x Female NPT	Lead-Free Brass Part #
3/4" x 3/4" x 1/2"	5091212CLF



#### Male GHT x Male NPTF



brass



lead-free brass



303 stainless

Male GHT	Male NPTF	Brass		Lead-Free Brass <sup>2</sup> Part #	Male Thread	303 Stainless		Pkg Qty
		Previous Part #	Part #			Previous Part #	Part #	
3/4"	3/8"	BA73	5081206C	---	---	---	---	25
	1/2"	BA74	5081208C	5081208CLF	NPT	RA74	5081208SS	25
	3/4"	---	5081212C	---	NPT	RA776	5081212SS	25
	3/4" x 1/2"	BA776	5141212C <sup>1</sup>	5141212CLF <sup>1,2</sup>	NPT	---	5141212SS <sup>1</sup>	25
	1"	BA78	5081216C	---	---	---	---	10

<sup>1</sup> Has 1/2" female NPT on I.D. of 3/4" male NPT side

<sup>2</sup> NSF®/ANSI 61 certified lead-free brass <=0.25% lead, Alloy C2745

### Male GHT Adapters

#### Male GHT

Male GHT	Male GHT	Brass		Male GHT	303 Stainless		Pkg Qty
		Previous Part #	Part #		Previous Part #	Part #	
3/4"	3/4"	BA777	5091212C	NPT	RA777	5091212SS	25
	1" <sup>1</sup>	509-1612	5091612C	---	---	---	20



brass



303 stainless

<sup>1</sup> NPSH thread

#### Female NPTF

Male GHT	Female NPTF	Brass		Lead-Free Brass Part #	Pkg Qty
		Previous Part #	Part #		
3/4"	1/4"	507-1204	5071204C	---	25
	3/8"	507-1206	5071206C	---	25
	1/2"	BA794	5071208C	---	25
	3/4"	BA796	5071212C	5071212CLF <sup>1</sup>	25



brass

Male GHT	Female NPT	303 Stainless		Pkg Qty
		Previous Part #	Part #	
3/4"	1/2"	RA794	5071208SS	25
	3/4"	RA796	5071212SS	25



303 stainless

<sup>1</sup> NSF®/ANSI 61 certified lead-free brass <=0.25% lead, Alloy C2745

### Female GHT Adapters

**Feature**

- All female GH include washer, 5911212W SBR rubber for standard brass and 5911212WEPDM for lead-free brass



brass



lead free brass

**Swivel**

Female x Female	Brass		Optional Qty
	Previous Part #	Part #	
3/4" x 3/4"	BA977	5061212C	25
	---	5061212CLF <sup>1</sup>	25

<sup>1</sup> NSF®/ANSI 61 certified lead-free brass <=0.25% lead, Alloy C2745

#### Female GHT Swivel x Female NPTF



Female GHT x Female NPTF	Brass		Lead-Free Brass Part #	303 Stainless		Pkg Qty
	Previous Part #	Part #		Previous Part #	Part #	
3/4"x 1/2"	BAS974	5021208C	5021208CLF <sup>1</sup>	RAS974	5021208SS <sup>2</sup>	25
3/4" x 3/4"	BAS976	5021212C	5021212CLF <sup>1</sup>	RAS976	5021212SS <sup>2</sup>	10

<sup>1</sup> NSF®/ANSI 61 certified lead-free brass <=0.25% lead, Alloy C2745

<sup>2</sup> NPT threads

#### Female GHT Swivel x Male NPTF



Female GHT	Male NPTF	Brass		Male NPT	303 Stainless		Pkg Qty
		Previous Part #	Part #		Previous Part #	Part #	
3/4"	1/4"	504-1204	5041204C	---	---	---	25
	3/8"	504-1206	5041206C	---	---	---	25
	1/2"	504-1208	5041208C	1/2"	R504-1208	5041208SS	25
	3/4"	504-1212	5041212C	3/4"	R504-1212	5041212SS	20

#### Rigid Female GHT x Male NPTF



Female GHT	Male Thread NPTF	Brass		Male Thread NPT	303 Stainless		Pkg Qty
		Previous Part #	Part #		Previous Part #	Part #	
3/4"	3/8"	BMA973	5031206C	---	---	---	25
	1/2"	BMA974	5031208C	1/2"	RMA974	5031208SS	25
	3/4"	BMA976	5031212C <sup>1</sup>	3/4"	RMA976	5031212SS <sup>2</sup>	25

<sup>1</sup> Has 1/2" female NPTF on I.D. of 3/4" male NPTF side

<sup>2</sup> Has 1/2" female NPT on I.D. of 3/4" male NPT side

#### Rigid Female GHT x Female NPTF



Female GHT	Female Thread NPTF	Brass		Female Thread NPT	303 Stainless		Pkg Qty
		Previous Part #	Part #		Previous Part #	Part #	
3/4"	1/8"	BA971	5011202C	---	---	---	50
	1/4"	BA972	5011204C	---	---	---	25
	3/8"	BA973	5011206C	---	---	---	25
	1/2"	BA974	5011208C	1/2"	RA974	5011208SS	25
	3/4"	BA976	5011212C	3/4"	RA976	5011212SS	25

**Hose Barbs and Inserts.....426 - 445**

Male x hose barbs ..... 426 - 427, 429, 431  
 Female x hose barbs ..... 427 - 429  
 Elbows ..... 429 - 431  
 Splicers ..... 428, 430  
 SAE / JIC ..... 431 - 432  
 Ferrules for air and fluid ..... 433  
 Ferrules for fluid ..... 433  
 Ribbed and plain dies ..... 434  
 Crimpers ..... 435 - 437  
 Crimp dies ..... 436 - 437  
 Push-on ..... 438 - 445  
 Hose assembly tool ..... 445  
 Lok-on caps ..... 445

**Reusable.....446 - 448**

**Pipe Fittings.....449 - 455**

Adapters ..... 449 - 450  
 Couplings ..... 449  
 Bushings ..... 449  
 Close nipples ..... 450  
 Nipples ..... 451 - 452  
 Elbows ..... 452 - 453  
 Tees ..... 453 - 454  
 Crosses ..... 454  
 Caps ..... 454  
 Plugs ..... 455

**Grease Whip Hose .....456 - 457**

Hose assemblies and fittings ..... 456  
 Zerk fittings ..... 457

**Oxy-Acetylene ..... 458**

## Hose Fittings

### Male NPTF x Hose Barb

**Feature**

- Optional package quantity

Hose I.D.	Male NPTF	Brass		Lead-Free Brass <sup>3</sup> Part #	316 Stainless Steel <sup>1</sup> Part #	Pkg Qty
		Previous Part #	Part #			
1/8"	1/8"	BN11	1020202C	---	RN11	100
	1/4"	BN122	1020204C	---	---	100
3/16"	1/8"	BN151	1020302C	1020302CLF	RN151	100
	1/4"	BN152	1020304C	---	RN152	100
1/4"	1/8"	BN21	1020402C	1020402CLF	RN21	100
	1/4"	BN22	1020404C	1020404CLF	RN22	100
	3/8"	BN23	1020406C	---	RN23	100
	1/2"	BN24	1020408C	---	---	50
5/16"	1/8"	BN251	1020502C	1020502CLF	RN251	100
	1/4"	BN252	1020504C	1020504CLF	RN252	50
	3/8"	BN253	1020506C	---	RN253	50
3/8"	1/8"	BN31	1020602C	1020602CLF	RN31	100
	1/4"	BN32	1020604C	1020604CLF	RN32	100
	3/8"	BN33	1020606C	1020606CLF	RN33	50
	1/2"	BN34	1020608C	1020608CLF	RN34	25
	3/4"	BN36	1020612C	---	---	25
1/2"	1/4"	BN42	1020804C	1020804CLF	RN42	50
	3/8"	BN43	1020806C	1020806CLF	RN43	50
	1/2"	BN44	1020808C	1020808CLF	RN44	25
	3/4"	BN46	1020812C	---	RN46	25
5/8"	3/8"	BN53	1021006C	---	RN53	50
	1/2"	BN54	1021008C	1021008CLF	RN54	25
	3/4"	BN56	1021012C	---	RN56	25
3/4"	3/8"	---	1021206C	---	---	25
	1/2"	BN64	1021208C	1021208CLF	RN64	25
	3/4"	BN66	1021212C	1021212CLF	RN66	20
1"	1/2"	---	1021608C	---	---	20
	3/4"	BN86	1021612C	---	RN86	20
	1"	BN88	1021616C <sup>2</sup>	---	1021616SS <sup>2,4</sup>	10
	1-1/4"	---	1021620C <sup>2</sup>	---	---	10
1-1/4"	3/4"	BN106	1022012C	---	---	10
	1"	BN108	1022016C <sup>2</sup>	---	---	5
1-1/2"	1"	---	1022416C <sup>2</sup>	---	---	5
	---	---	1022420C <sup>2</sup>	---	---	5

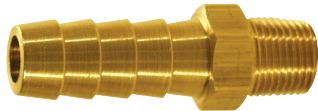

brass



316 stainless steel

<sup>1</sup> NPT thread

<sup>2</sup> Capped

<sup>3</sup> NSF®/ANSI 61 certified Lead-Free Brass <=0.25% lead, Alloy C2745

<sup>4</sup> Part is 316SS cast

### Male NPTF Swivel x Hose Barb

**Feature**

- Optional package quantity

Hose I.D.	Male NPTF	Brass		Pkg Qty
		Previous Part #	Part #	
1/4"	1/8"	103-0402	1030402C	100
	1/4"	103-0404	1030404C	100
	3/8"	---	1030406C	100
5/16"	1/4"	---	1030504C	100
3/8"	1/4"	103-0604	1030604C	100
	3/8"	103-0606	1030606C	50
1/2"	3/8"	103-0806	1030806C	50
	1/2"	103-0808	1030808C	25
5/8"	1/2"	---	1031008C	25
	1/4"	---	1031204C	20
3/4"	1/2"	---	1031208C	20
	3/4"	103-1212	1031212C	20
1"	1-11-1/2"	103-1616	1031616C <sup>1</sup>	10



<sup>1</sup> Capped threads

NOTE: Swivel for assembly convenience only, not for live swivel applications; operational PSI is 80

### Hose Fittings

#### Male NPTF x Beaded Hose Barb

Hose I.D.	Male NPTF	Brass Part #	Pkg Qty
1/4"	1/8"	268B0402	100
	1/4"	268B0404	100
5/16"	1/8"	268B0502	100
	1/4"	268B0504	50
3/8"	1/8"	268B0602	100
	1/4"	268B0604	100
	3/8"	268B0606	50
1/2"	3/8"	268B0806	50
	1/2"	268B0808	50
5/8"	1/2"	268B1008	25
3/4"	1/2"	268B1208	50
	3/4"	268B1212	25



#### Male BSPT x Hose Barb

Hose I.D.	Male BSPT	Brass		Pkg Qty
		Previous Part #	Part #	
1/4"	1/8"	BN21BSPT	1020402BSPT	100
	1/4"	BN22BSPT	1020404BSPT	100
3/8"	1/4"	BN32BSPT	1020604BSPT	100
	3/8"	BN33BSPT	1020606BSPT	50
	1/2"	BN34BSPT	1020608BSPT	25
1/2"	3/8"	BN43BSPT	1020806BSPT	50
	1/2"	BN44BSPT	1020808BSPT	50
3/4"	3/4"	BN66BSPT	1021212BSPT	25
1"	1"	BN88BSPT	1021616BSPT	10



#### Female NPTF x Hose Barb

Hose I.D.	Female NPTF	Brass		Lead-Free Brass <sup>2</sup> Part #	303 Stainless Steel <sup>1</sup>		Pkg Qty
		Previous Part #	Part #		Previous Part #	Part #	
1/8"	1/8"	BF11	1040202C	---	---	---	100
	1/4"	BF12	1040204C	---	---	---	100
3/16"	1/8"	BF151	1040302C	---	---	---	100
	1/4"	BF152	1040304C	---	---	---	100
1/4"	1/8"	BF21	1040402C	---	---	---	100
	1/4"	BF22	1040404C	1040404CLF	BF22SS	1040404SS	100
	3/8"	BF23	1040406C	---	---	---	50
	1/2"	BF24	1040408C	---	---	---	50
5/16"	1/8"	BF251	1040502C	---	---	---	100
	1/4"	BF252	1040504C	---	---	---	100
	3/8"	BF253	1040506C	---	---	---	100
3/8"	1/8"	BF31	1040602C	---	---	---	100
	1/4"	BF32	1040604C	1040604CLF	BF32SS	1040604SS	50
	3/8"	BF33	1040606C	1040606CLF	BF33SS	1040606SS	50
	1/2"	BF34	1040608C	1040608CLF	---	---	50
	3/4"	BF36	1040612C	---	---	---	25
1/2"	1/4"	BF42	1040804C	---	---	---	50
	3/8"	BF43	1040806C	---	---	---	50
	1/2"	BF44	1040808C	1040808CLF	BF44SS	1040808SS	50
	3/4"	BF46	1040812C	---	---	---	25
5/8"	3/8"	BF53	1041006C	---	---	---	50
	1/2"	BF54	1041008C	---	---	---	25
	3/4"	BF56	1041012C	---	---	---	25
3/4"	1/2"	BF64	1041208C	---	---	---	25
	3/4"	BF66	1041212C	---	---	---	20
1"	3/4"	BF86	1041612C	---	---	---	20
	1"	BF88	1041616C	1041616CLF	---	---	10
1-1/4"	1"	BF108	1042016C	---	---	---	10



brass



303 stainless steel

<sup>1</sup> NPT threads

<sup>2</sup> NSF®/ANSI 61 certified Lead-Free Brass <=0.25% lead, Alloy C2745

**Hose Fittings**

**Female NPSM Swivel x Hose Barb Ball Seat**



Hose I.D.	Female NPSM	Brass		Pkg Qty
		Previous Part #	Part #	
1/8"	1/8"	BFS11	1240202K	100
3/16"	1/8"	BFS151	1240302K	100
	1/4"	BFS152	1240304K	100
1/4"	1/8"	BFS21	1240402K	100
	1/4"	BFS22	1240404K	100
	3/8"	BFS23	1240406K	100
5/16"	1/4"	BFS252	1240504K	100
	3/8"	BFS253	1240506K	50
3/8"	1/4"	BFS32	1240604K	100
	3/8"	BFS33	1240606K	100
	1/2"	BFS34	1240608K	100
1/2"	3/8"	BFS43	1240806K	50
	1/2"	BFS44	1240808K	100
3/4"	3/4"	BFS66	1241212K	50

**Female NPSM Swivel x Hose Barb Gasket Seat**



Hose I.D.	Female NPSM	Brass		Pkg Qty
		Previous Part #	Part #	
1/8"	1/8"	126-0202	1260202C	100
3/16"	1/8"	126-0302	1260302C	100
	1/4"	126-0304	1260304C	100
1/4"	1/8"	126-0402	1260402C	100
	1/4"	126-0404	1260404C	100
	3/8"	126-0406	1260406C	100
5/16"	1/4"	126-0504	1260504C	100
3/8"	1/4"	126-0604	1260604C	100
	3/8"	126-0606	1260606C	50
	1/2"	126-0608	1260608C	50
1/2"	3/8"	126-0806	1260806C	50
	1/2"	126-0808	1260808C	50
3/4"	3/4"	126-1212	1261212C	25

NOTE: Parts include 80 duro neoprene Washer

**Barbed Hose Menders (Splicers)**



Hose I.D.	Lead-Free Brass <sup>1</sup> Part #	Brass		Pkg Qty
		Previous Part #	Part #	
1/8"	---	BM1	1780202C	100
3/16"	---	BM15	1780303C	100
1/4" x 1/8"	---	BM2-1	1780402C	100
1/4"	1780404CLF	BM2	1780404C	100
5/16"	---	BM25	1780505C	100
3/8" x 1/4"	---	BM3-2	1780604C	100
3/8"	1780606CLF	BM3	1780606C	100
1/2" x 1/4"	---	---	1780804C	50
1/2" x 3/8"	---	BM4-3	1780806C	50
1/2"	1780808CLF	BM4	1780808C	50
5/8" x 3/8"	---	BM5-3	1781006C	50
5/8" x 1/2"	---	BM5-4	1781008C	50
5/8"	---	BM5	1781010C	50
3/4" x 1/2"	---	BM6-4	1781208C	25
3/4"	---	BM6	1781212C	25
1" x 3/4"	---	---	1781612C	10
1"	---	BM8	1781616C	10

<sup>1</sup> NSF®/ANSI 61 certified Lead-Free Brass <=0.25% lead, Alloy C2745

### Hose Fittings

#### Male NPTF x Hose Barb 90° Elbow

Hose I.D.	Male NPTF	Brass		Lead-Free Brass <sup>2,3</sup> Part #	Pkg Qty
		Previous Part #	Part #		
3/16"	1/8"	EL15H1M	1290302C	---	50
	1/8"	EL2H1M	1290402C	---	50
1/4"	1/4"	EL2H2M	1290404C	1290404CLF	50
	3/8"	EL2H3M	1290406C	---	50
5/16"	1/8"	EL25H1M	1290502C	---	25
	1/4"	EL25H2M	1290504C	---	50
	3/8"	EL25H3M	1290506C	---	50
3/8"	1/8"	EL3H1M	1290602C	---	50
	1/4"	EL3H2M	1290604C	1290604CLF	50
	3/8"	EL3H3M	1290606C	1290606CLF	50
	1/2"	EL3H4M	1290608C	---	25
1/2"	1/4"	EL4H2M	1290804C	---	50
	3/8"	EL4H3M	1290806C	---	50
	1/2"	EL4H4M	1290808C	---	25
5/8"	3/8"	EL5H3M	1291006C	---	25
	1/2"	EL5H4M	1291008C	---	25
3/4"	1/2"	EL6H4M	1291208C	---	25
	3/4"	EL6H6M	1291212C	---	25
1"	3/4"	EL8H6M	1291612C	---	10
	1"	EL8H8M	1291616C <sup>1</sup>	---	10



- <sup>1</sup> Capped
- <sup>2</sup> Lead-free brass <=0.25% lead; Alloy CA2745; Alloy C46400
- <sup>3</sup> NPT thread

Hose I.D.	Male NPT	316 Stainless Steel		Pkg Qty
		Previous Part #	Part #	
1/4"	1/8"	EL2H1MSS	1290402SS	50
	1/4"	EL2H2MSS	1290404SS	50
3/8"	1/4"	EL3H2MSS	1290604SS	50
	3/8"	EL3H3MSS	1290606SS	50
1/2"	1/4"	EL4H2MSS	1290804SS	50
	3/8"	EL4H3MSS	1290806SS	50
	1/2"	EL4H4MSS	1290808SS	25
3/4"	1/2"	EL6H4MSS	1291208SS	25
	3/4"	EL6H6MSS	1291212SS	25



#### Female NPTF x Hose Barb 90° Elbow

Hose I.D.	Female NPTF	Brass		Pkg Qty
		Previous Part #	Part #	
1/4"	1/8"	134-0402	1340402C	50
	1/4"	134-0404	1340404C	50
3/8"	1/4"	134-0604	1340604C	50
	3/8"	134-0606	1340606C	50
1/2"	1/4"	134-0804	1340804C	25
	3/8"	134-0806	1340806C	25
	1/2"	134-0808	1340808C	25
3/4"	3/4"	134-1212	1341212C	25



Hose Fittings

Barbed 90° Elbow Splicers



brass



304 stainless steel

Hose I.D.	Brass		304 Stainless Steel		Pkg Qty
	Previous Part #	Part #	Previous Part #	Part #	
1/8"	177-0202	1770202C	---	---	25
3/16"	177-0303	1770303C	---	---	25
1/4" x 1/8"	177-0402	1770402C	---	---	25
1/4"	177-0404	1770404C	177-0404SS	1770404SS	25
5/16"	177-0505	1770505C	---	---	25
3/8" x 1/4"	177-0604	1770604C	---	---	25
3/8"	177-0606	1770606C	177-0606SS	1770606SS	25
1/2" x 3/8"	177-0806	1770806C	---	---	25
1/2"	177-0808	1770808C	177-0808SS	1770808SS	25
5/8"	177-1010	1771010C	---	---	25
3/4" x 1/2"	177-1208	1771208C	---	---	25
3/4"	177-1212	1771212C	---	---	25

Barbed Tee Splicers



brass



brass with male NPTF



lead-free brass



304 stainless steel

Hose I.D.	Brass		Lead-Free Brass Part #	Pkg Qty
	Previous Part #	Part #		
1/8"	179-0202	1790202C	---	25
3/16"	179-0303	1790303C	---	100
1/4" x 1/8"	179-0402	1790402C	---	25
1/4"	179-0404	1790404C	1790404CLF	25
5/16"	179-0505	1790505C	---	25
3/8" x 1/4"	179-0604	1790604C <sup>1</sup>	---	25
3/8" x 1/4"	---	1790604BARB	---	25
3/8"	179-0606	1790606C	1790606CLF	25
1/2" x 3/8"	179-0806	1790806C	---	25
1/2"	179-0808	1790808C	---	25
5/8"	179-1010	1791010C	---	25
3/4" x 1/2"	179-1208	1791208C	---	25
3/4"	179-1212	1791212C	---	20

<sup>1</sup> Drop leg has 1/4"-18 male NPTF thread

Hose I.D.	304 Stainless Steel		Pkg Qty
	Previous Part #	Part #	
1/4"	179-0404SS	1790404SS	25
3/8"	179-0606SS	1790606SS	25
1/2"	179-0808SS	1790808SS	25



### Hose Fittings

#### Male NPTF x Hose Barb 45° Elbow

Hose I.D.	Male NPTF	Brass		Pkg Qty
		Previous Part #	Part #	
1/4"	1/8"	139-0402	1390402C	100
	1/4"	139-0404	1390404C	25
3/8"	1/8"	139-0602	1390602C	100
	1/4"	139-0604	1390604C	100
	3/8"	139-0606	1390606C	25
1/2"	1/4"	139-0804	1390804C	25
	3/8"	139-0806	1390806C	25
	1/2"	139-0808	1390808C	25
3/4"	1/2"	139-1208	1391208C	25



#### Male 45° SAE x Hose Barb

Hose I.D.	Tube O.D.	Male UNF	Brass		Pkg Qty
			Previous Part #	Part #	
3/16"	1/4"	7/16"-20	142-0307	1420307C	100
1/4"	1/4"	7/16"-20	142-0407	1420407C	100
	3/8"	5/8"-18	142-0410	1420410C	100
5/16"	5/16"	1/2"-20	142-0508	1420508C	100
3/8"	3/8"	5/8"-18	142-0610	1420610C	50
	1/2"	3/4"-16	142-0612	1420612C	50
1/2"	1/2"	3/4"-16	142-0812	1420812C	50



#### Female 45° SAE/37° JIC Swivel x Hose Barb

Hose I.D.	Tube O.D.	Female UNF	Brass		Pkg Qty
			Previous Part #	Part #	
3/16"	1/4"	7/16"-20	143-0307	1430307K	100
1/4"	1/4"	7/16"-20	143-0407	1430407K	100
			---	1430407KLF <sup>1</sup>	100
	5/16"	5/16"	1/2"-20	143-0408	1430408K
5/16"	5/16"	1/2"-20	143-0508	1430508K	50
3/8"	1/2"	3/4"-16	143-0612	1430612K	100
1/2"	1/2"	3/4"-16	143-0812	1430812K	100
	5/8"	7/8"-14	143-0814	1430814K	50



<sup>1</sup> NSF®/ANSI 61 certified Lead-Free Brass <=0.25% lead, Alloy C2745

Hose Fittings

Female 45° SAE Swivel x Hose Barb



Hose I.D.	Tube O.D.	Female UNF	Brass		Pkg Qty
			Previous Part #	Part #	
3/16"	3/16"	3/8"-24	144-0306	1440306K	100
1/4"	3/8"	5/8"-18	144-0410	1440410K	100
5/16"	3/8"	5/8"-18	144-0510	1440510K	100
3/8"	3/8"	5/8"-18	144-0610	1440610K	100
1/2"	1/2"	3/4"-16	144-0812	1440812K	100
3/4"	3/4"	1-1/16"-14	144-1217	1441217K <sup>1</sup>	25

<sup>1</sup> Notch in nut for SAE identification

Female 37° JIC Swivel x Hose Barb



Hose I.D.	Tube O.D.	Female UNF	Brass		Pkg Qty
			Previous Part #	Part #	
3/8"	3/8"	9/16"-18	145-0609	1450609K	100
3/4"	3/4"	1-1/16"-12	145-1217	1451217K	25

Female PTF-SAE Short Swivel x Hose Barb<sup>1</sup>



Hose I.D.	Female PTF-SAE Short	Brass		Pkg Qty
		Previous Part #	Part #	
1/4"	1/4"	105-0404	1050404C	50
	3/8"	---	1050406C	100
5/16"	1/4"	---	1050504C	50
	3/8"	105-0604	1050604C	50
3/8"	3/8"	105-0606	1050606C	50
	1/2"	105-0806	1050806C	50
1/2"	1/2"	105-0808	1050808C	25
	5/8"	---	1051008C	25
3/4"	1/4"	---	1051204C	25
	1/2"	---	1051208C	25

<sup>1</sup> Swivel is for assembly convenience only, not for live swivel application; operational PSI is 80

### Hose Fittings

#### Brass Ferrules for Air & Fluid

**Feature**

- Sold in package quantities only

Ferrule I.D.	Ferrule Length	End Hole Size	Metal Gauge	Std Ind Part #	Bore/Crimp Diameter <sup>1</sup>	Previous Part #	Brass Part #	Pkg Qty
.478"	.688	.328	.024"	4750	0.450	2004750C	BFM478	50
.500"	1	.344	.024"	7322	0.475	2005005C	BFM500	50
.528"	1	.375	.024"	7323	0.500	2005255C	BFM525	50
.528"	1	.438	.024"	7324	0.500	2005310C	BFM531	50
.562"	1	.438	.024"	7325	0.525	2005620C	BFM562	50
.593"	1	.438	.024"	7326	0.550	2005930C	BFM593	50
.625"	1	.438	.024"	7327	0.575	2006255C	BFM625	50
.656"	1	.438	.024"	7328	0.600	2006560C	BFM656	50
.687"	1	.500	.024"	7329	0.625	2006900C	BFM687	50
.718"	1	.625	.024"	7330	0.675	2007180C	BFM718	50
.718"	1	.500	.024"	7330B	0.675	---	BFM718B	50
.750"	1	.625	.024"	7331	0.700	2007505C	BFM750	50
.750"	1	.500	.024"	7331B	0.700	---	BFM750B	50
.781"	1	.625	.024"	7332	0.725	2007810C	BFM781	50
.781"	1	.500	.024"	7332B	0.725	---	BFM781B	50
.812"	1	.625	.024"	7333	0.750	2008120C	BFM812	50
.380"	.500	.266	.016"	622	0.350	---	BFL380	50
.400"	.469	.266	.020"	619	0.375	2004000C	BFL400	50
.410"	.500	.266	.016"	620	0.375	---	BFL410	50
.450"	.469	.344	.016"	769	0.425	2004530C	BFL450	50
.500"	.500	.344	.016"	624	0.450	2005000C	BFL500	50
.525"	.500	.344	.016"	625	0.475	2005250C	BFL525	50
.548"	.484	.375	.016"	626	0.500	2005500C	BFL548	50
.564"	.750	.375	.019"	3588	0.525	---	BFL564	50
.575"	.484	.469	.019"	KK	0.525	---	BFL575	50
.600"	.500	.500	.019"	JJ	0.550	---	BFL600	50
.625"	.500	.500	.019"	II	0.575	2006250C	BFL625	50
.650"	.500	.500	.019"	HH	0.600	2006500C	BFL650	50
.675"	.516	.500	.019"	GG	0.625	2006750C	BFL675	50
.725"	.531	.500	.019"	EE	0.675	2007250C	BFL725	50
.750"	.531	.500	.019"	DD	0.675	2007500C	BFL750	50
.775"	.531	.500	.016"	CC	0.700	2007750C	BFL775	50



BFM



BFL

<sup>1</sup> Plain die bore diameter can be used as crimp spec ±.005

NOTE: For use with ribbed and plain dies on page 434

#### Brass Ferrules for Fluid

**Feature**

- Sold in package quantities only

Ferrule I.D.	Ferrule Length	End Hole Size	Metal Gauge	Std Ind Part #	Ribbed Die*	Plain Die*	Bore/Crimp Diameter <sup>1</sup>	Previous Part #	Brass Part #	Pkg Qty
.800"	.844"	.688"	.024"	---	R28	P29	0.750	---	BF800	25
.825"	.844"	.688"	.024"	---	R27	P28	0.775	---	BF825	25
.850"	.563"	.688"	.019"	Z	R26	P27	0.800	---	BF850	25
.875"	.844"	.688"	.024"	7244A	R25	P26	0.825	2008750C	BFW875	25
.900"	.844"	.688"	.024"	5029A	R24	P25	0.850	---	BFW900	25
.937"	.844"	.688"	.024"	7242A	R23	P24	0.875	2009250C	BFW925	25
.975"	.844"	.688"	.024"	5028A	R21	P22	0.925	2009750C	BFW975	25
1.025"	.844"	.693"	.024"	7114A	R19	P20	0.975	2001025C	BFW1025	25
1.175"	.844"	.875"	.024"	7088A	R13	P14	1.125	2001175C	BFW1175	25
1.050"	.625"	.750"	.025"	3605	R18	P19	1.000	---	BFMW1050	25
1.100"	.844"	.812"	.024"	5027A	R16	P17	1.050	2001100C	BFMW1100	25
1.150"	.844"	.875"	.024"	7104A	R15	P15	1.100	2009950C	BFMW1150	25
1.225"	.875"	.875"	.025"	875-K	R11	P12	1.175	2001225C	BFMW1225	25
1.275"	.875"	1.000"	.025"	875-I	R9	P10	1.225	---	BFMW1275	25
1.400"	.687"	1.125"	.019"	D	R4	P5	1.350	---	BFMW1400	25
1.500"	.875"	1.125"	.025"	1500	---	P1	1.450	2001500C	BFMW1500	25



BFMW

<sup>1</sup> Plain die bore diameter can be used as crimp spec ±.005

NOTE: For use with ribbed and plain dies on page 434

Ribbed and Plain Dies

Ferrule I.D.	Std Ind Part #	Bore/Crimp Diameter <sup>1</sup>	Ribbed Die	Plain Die
.478"	4750	0.450	R41	P42
.500"	7322	0.475	R40	P40
.528"	7323	0.500	R39	P39
.528"	7324	0.500	R39	P39
.562"	7325	0.525	R37	P38
.593"	7326	0.550	R36	P37
.625"	7327	0.575	R35	P36
.656"	7328	0.600	R34	P35
.687"	7329	0.625	R33	P34
.718"	7330	0.675	R31	P32
.718"	7330B	0.675	R31	P32
.750"	7331	0.700	R30	P31
.750"	7331B	0.700	R30	P31
.781"	7332	0.725	R29	P30
.781"	7332B	0.725	R29	P30
.812"	7333	0.750	R28	P29
.380"	622	0.350	R44	P45
.400"	619	0.375	R44	P44
.410"	620	0.375	R43	P44
.450"	769	0.425	R41	P42
.500"	624	0.450	R40	P41
.525"	625	0.475	R39	P40
.548"	626	0.500	R38	P39
.564"	3588	0.525	R37	P38
.575"	KK	0.525	R37	P38
.600"	JJ	0.550	R36	P37
.625"	II	0.575	R35	P36
.650"	HH	0.600	R34	P35
.675"	GG	0.625	R34	P34
.725"	EE	0.675	R31	P32
.750"	DD	0.675	R30	P32
.775"	CC	0.700	R31	P31
.800"	--	0.750	R28	P29
.825"	--	0.775	R27	P28
.850"	Z	0.800	R26	P27
.875"	7244A	0.825	R25	P26
.900"	5029A	0.850	R24	P25
.937"	7242A	0.875	R23	P24
.975"	5028A	0.925	R21	P22
1.025"	7114A	0.975	R19	P20
1.175"	7088A	1.125	R13	P14
1.050"	3605	1.000	R18	P19
1.100"	5027A	1.050	R16	P17
1.150"	7104A	1.100	R15	P15
1.225"	875-K	1.175	R11	P12
1.275"	875-I	1.225	R9	P10
1.400"	D	1.350	R4	P5
1.500"	1500	1.450	--	P1



P29



R28

<sup>1</sup> Plain die bore diameter can be used as crimp spec ±.005  
 NOTE: Dies for use with 5111A and 1765A ferrule machines on page 436.

## Manually - Operated Brass Ferrule Crimper

**Sizes**

- Height: 27" with handle upright
- Base: 8" x 3"
- Body: 7-3/8"

**Features**

- Crimps all brass ferrules shown on page 433
- Does not include dies
- Dies for ferrule machines are available in standard sets for all ferrules as tabulated
- (4 segments to a set), supplied with plain or ribbed crimping surface

---

**Part #**

5111A



## Air-Operated Brass Ferrule Crimper

**Application**

- Provides efficient mass production assembly of hose, ferrules, and fittings

**Features**

- The foot pedal permits the use of both hands, reduces fatigue, and speeds production
- Complete with air cylinder, ferrule machine (less dies), fitted hose lengths, and necessary control valves
- Ready for work bench installation
- Crimps all brass ferrules shown on page 433

---

**Part #**

1765A



NOTE: Die sizes for ferrules and machine numbers 1765A and 5111A are on page 434.

## Small Hose Crimpers

### Application

- Hose crimper provides "big tool" crimping advantages at a fraction of the cost



### Feature

- Rugged, portable, and easy to use

### Specifications

- 855 crimper with (5) dies for 31/64" (0.484") to 45/64" (0.703") O.D. hose
- 855A crimper with (5) dies for 28/64" (0.437") to 43/64" (0.671") O.D. hose
- Optional dies up to 52/64" O.D. available

Previous Part #	Part #
200FC	855
---	855A

## Small Hose Crimper Dies



Die Bore	Hose O.D.		Crimper # 855	Crimper # 855A	Previous Part #	Die Part #
	from	to				
.375"	.385"	.406"	optional	optional	200FC3	856-10
.437"	.447"	.468"	optional	standard	---	856-7
.484"	.490"	.520"	standard	standard	200FC4A	856-4
.531"	.540"	.562"	standard	standard	200FC4B	856-3
.578"	.590"	.625"	standard	standard	200FC5	856-2
.625"	.640"	.671"	standard	standard	200FC6A	856-1
.687"	.690"	.710"	standard	optional	200FC6B	856-5
.750"	.760"	.781"	optional	optional	200FC8A	856-8
.812"	.820"	.843"	optional	optional	200FC8B	856-9

## Large Hose Crimper

### Application

- For crimping 1/2" to 1" I.D. hoses with larger O.D.s, from 11/16" to 1-1/2"

### Features

- Crimps standard brass or aluminum ferrules
- Order separate dies for each hose diameter
- Dies sold separately



### Crimper Part #

860

## Large Hose Crimper Dies

Hose O.D./ Finished Crimp Dimension	Hose O.D.		Die Part #
	From	To	
11/16"	.687"	.765"	861-22
23/32"	.718"	.796"	861-23
3/4"	.750"	.828"	861-24
25/32"	.781"	.860"	861-25
13/16"	.812"	.890"	861-26
27/32"	.843"	.921"	861-27
7/8"	.875"	.953"	861-28
29/32"	.906"	.985"	861-29
15/16"	.937"	1.010"	861-30
31/32"	.968"	1.040"	861-31
1"	1.000"	1.070"	861-32
1-1/32"	1.031"	1.110"	861-33
1-1/16"	1.062"	1.114"	861-34
1-1/8"	1.125"	1.208"	861-36
1-3/16"	1.187"	1.265"	861-38
1-1/4"	1.250"	1.321"	861-40
1-5/16"	1.312"	1.390"	861-42
1-3/8"	1.375"	1.453"	861-44
1-7/16"	1.437"	1.551"	861-46
1-1/2"	1.500"	1.578"	861-48

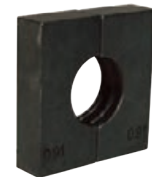

Push-On Hose Barb Fittings

Assembly Instructions

1. Trim hose end with smooth square cut
2. Lubricate either push-on fitting, hose, or both.
3. Insert push-on fitting into hose until first barb is in hose.
4. Place end of fitting against a flat object (bench, wall, etc.) and grip the hose one inch from end. Push with a steady force until end of hose is covered by yellow plastic cap.

Disassembly Instructions

1. Leaving push-on fitting in place, make a 1" cut in the hose along the barbed end of the fitting. Note: Be careful not to nick barbs when cutting the hose.
  2. With firm grip on hose, give a sharp downward pull to release the fitting from the hose.
- Intended for use with Lok-On (push-on style) hose only
  - No hose clamps or ferrules are needed for installation
  - Properly grips push-on hose only when pushed all the way in, with the cut end of the hose completely concealed by the plastic cap.



Male NPTF x Hose Barb

Hose I.D.	Male NPTF	Brass			Brass Cap Option		Lead-Free Brass <sup>1</sup>	Pkg Qty
		Previous Part #	Part #	Pkg Qty	Part #	Pkg Qty	Part #	
1/4"	1/8"	BPN21	2720402C	100	2720402CBC	100	2720402CLF	100
	1/4"	BPN22	2720404C	100	2720404CBC	100	2720404CLF	100
	3/8"	BPN23	2720406C	50	2720406CBC	50	---	---
5/16"	1/8"	BPN251	2720502C	100	---	---	---	---
	1/4"	BPN252	2720504C	50	---	---	---	---
3/8"	1/8"	BPN31	2720602C	100	2720602CBC	100	---	---
	1/4"	BPN32	2720604C	50	2720604CBC	50	2720604CLF	50
	3/8"	BPN33	2720606C	50	2720606CBC	50	2720606CLF	50
	1/2"	BPN34	2720608C	25	2720608CBC	25	---	---
	3/4"	BPN36	2720612C	25	2720612CBC	25	---	---
1/2"	1/4"	BPN42	2720804C	25	2720804CBC	25	---	---
	3/8"	BPN43	2720806C	25	2720806CBC	25	2720806CLF	50
	1/2"	BPN44	2720808C	50	2720808CBC	50	2720808CLF	25
5/8"	3/4"	BPN46	2720812C	50	2720812CBC	50	---	---
	3/8"	BPN53	2721006C	25	2721006CBC	25	---	---
	1/2"	BPN54	2721008C	25	2721008CBC	25	---	---
3/4"	3/4"	BPN56	2721012C	25	2721012CBC	25	---	---
	1/2"	BPN64	2721208C	25	2721208CBC	25	---	---
	3/4"	BPN66	2721212C	25	2721212CBC	25	---	---
1"	3/4"	BPN86	2721612C	10	---	---	---	---
	1"	BPN88	2721616C <sup>2</sup>	10	---	---	---	---



brass



brass cap



303 stainless steel

Hose I.D.	Male NPT	303 Stainless Steel		Pkg Qty
		Previous Part #	Part #	
1/4"	1/8"	RPN21	2720402SS	100
	1/4"	RPN22	2720404SS	100
3/8"	1/4"	RPN32	2720604SS	50
	3/8"	RPN33	2720606SS	50
1/2"	1/4"	RPN42	2720804SS	25
	3/8"	RPN43	2720806SS	50
	1/2"	RPN44	2720808SS	25
3/4"	1/2"	RPN64	2721208SS	25
	3/4"	RPN66	2721212SS	20
1"	1"	RPN88	2721616SS <sup>2</sup>	5

<sup>1</sup> NSF®/ANSI 61 certified Lead-Free Brass <=0.25% lead, Alloy C2745

<sup>2</sup> Capped

NOTE: Refer to page 441 for push-on garden hose thread fittings

NOTE: Optional package quantity

Male NPTF Swivel x Hose Barb

Hose I.D.	Male NPTF	Brass		Pkg Qty
		Previous Part #	Part #	
1/4"	1/8"	271-0402	2710402C	100
	1/4"	271-0404	2710404C	50
3/8"	1/4"	271-0604	2710604C	50
	3/8"	271-0606	2710606C	50
1/2"	3/8"	271-0806	2710806C	25
	1/2"	271-0808	2710808C	20
3/4"	3/4"	271-1212	2711212C	10

NOTE: Swivel for assembly convenience only, not for live swivel applications; operational PSI is 80



### Push-On Hose Barb Fittings

**Application**

- Intended for use with Lok-On (push-on style) hose only



**Features**

- No hose clamps or ferrules are needed for installation
- Properly grips push-on hose only when pushed all the way in, with the cut end of the hose completely concealed by the plastic cap

#### Male NPTF x Hose Barb 90° Elbow

Hose I.D.	Male NPTF	Brass		Pkg Qty
		Previous Part #	Part #	
1/4"	1/8"-27	273-0402	2730402C	100
	1/4"-18	273-0404	2730404C	50
3/8"	1/8"-27	273-0602	2730602C	50
	1/4"-18	273-0604	2730604C	50
	3/8"-18	273-0606	2730606C	25
1/2"	3/8"-18	273-0806	2730806C	25
	1/2"-14	273-0808	2730808C	25
3/4"	1/2"-14	273-1208	2731208C	10
	3/4"-14	273-1212	2731212C	10



#### Female NPTF x Hose Barb

**Feature**

- Refer to page 441 for push-on garden hose thread fittings

Hose I.D.	Female NPTF	Brass		Pkg Qty
		Previous Part #	Part #	
1/4"	1/8"	BPF21	2740402C	100
		---	2740402CBC <sup>1</sup>	100
	1/4"	BPF22	2740404C	100
		---	2740404CBC <sup>1</sup>	100
3/8"	3/8"	BPF23	2740406C	50
		---	2740406CBC <sup>1</sup>	50
5/16"	1/8"	BPF251	2740502C	100
	1/4"	BPF252	2740504C	50
3/8"	1/8"	BPF31	2740602C	50
		---	2740602CBC <sup>1</sup>	50
	1/4"	BPF32	2740604C	50
		---	2740604CBC <sup>1</sup>	50
	3/8"	BPF33	2740606C	50
		---	2740606CBC <sup>1</sup>	50
	1/2"	BPF34	2740608C	50
	3/4"	BPF36	2740612C	25
1/2"	1/4"	BPF42	2740804C	50
		---	2740804CBC <sup>1</sup>	50
	3/8"	BPF43	2740806C	50
		---	2740806CBC <sup>1</sup>	50
	1/2"	BPF44	2740808C	25
		---	2740808CBC <sup>1</sup>	25
	3/4"	BPF46	2740812C	25
		---	2740812CBC <sup>1</sup>	25
5/8"	3/8"	BPF53	2741006C	25
	1/2"	BPF54	2741008C	25
		---	2741008CBC <sup>1</sup>	25
	3/4"	BPF56	2741012C	25
3/4"	1/2"	BPF64	2741208C	25
		BPF66	2741212C	25
	3/4"	---	2741212CBC <sup>1</sup>	25
1"	3/4"	BPF86	2741612C	10
	1"	BPF88	2741616C	10

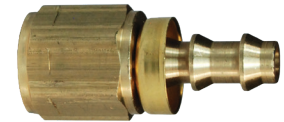

brass cap

<sup>1</sup> Brass cap on CBC parts

### Push-On Hose Barb Fittings

**Application**

- Intended for use with Lok-On (push-on style) hose only

**Features**

- No hose clamps or ferrules are needed for installation
- Properly grips push-on hose only when pushed all the way in, with the cut end of the hose completely concealed by the plastic cap



**Female NPSM Swivel x Hose Barb Ball Seat**



brass cap

Hose I.D.	Female NPSM	Brass		Pkg Qty
		Previous Part #	Part #	
1/4"	1/8"	BPFS21	2780402C	100
		---	2780402CBC <sup>1</sup>	100
	1/4"	BPFS22	2780404C	50
		---	2780404CBC <sup>1</sup>	50
3/8"	3/8"	BPFS23	2780406C	50
		---	2780406CBC <sup>1</sup>	50
	1/4"	BPFS32	2780604C	50
		---	2780604CBC <sup>1</sup>	50
1/2"	3/8"	BPFS33	2780606C	50
		---	2780606CBC <sup>1</sup>	50
	1/2"	BPFS34	2780608C	25
		---	2780608CBC <sup>1</sup>	25
3/4"	1/2"	BPFS44	2780808C	50
		---	2780808CBC <sup>1</sup>	50
	3/4"	BPFS46	2780812C	25
		---	2780812CBC <sup>1</sup>	20
5/8"	3/4"	BPFS56	2781012C	20
3/4"	3/4"	BPFS66	2781212C	20
		---	2781212CBC <sup>1</sup>	---

<sup>1</sup> Brass cap on CBC parts

**Female NPSM Swivel x Hose Barb Gasket Seat**



brass cap

Hose I.D.	Female NPSM	Brass		Pkg Qty
		Previous Part #	Part #	
1/4"	1/8"	280-0402	2800402C	100
		---	2800402CBC <sup>1</sup>	100
	1/4"	280-0404	2800404C	100
		---	2800404CBC <sup>1</sup>	100
3/8"	1/4"	280-0604	2800604C	50
		---	2800604CBC <sup>1</sup>	50
	3/8"	280-0606	2800606C	50
		---	2800606CBC <sup>1</sup>	50
1/2"	1/2"	280-0608	2800608C	50
		---	2800608CBC <sup>1</sup>	50
	1/2"	280-0808	2800808C	25
		---	2800808CBC <sup>1</sup>	25
5/8"	1/2"	280-1008	2801008C	25
3/4"	3/4"	280-1212	2801212C	20
		---	2801212CBC <sup>1</sup>	20

<sup>1</sup> Brass cap on CBC parts

NOTE: Parts include 80 duro neoprene washer

**Hose Menders**



brass cap

Hose I.D.	Brass		303 Stainless Steel		Pkg Qty
	Previous Part #	Part #	Previous Part #	Part #	
1/4"	BPM2	2960404C	SSPM2	2960404SS	100
	---	2960404CBC <sup>1</sup>	---	---	100
5/16"	BPM25	2960505C	---	---	100
3/8"	BPM3	2960606C	SSPM3	2960606SS	50
	---	2960606CBC <sup>1</sup>	---	---	50
1/2"	BPM4	2960808C	SSPM4	2960808SS	50
	---	2960808CBC <sup>1</sup>	---	---	50
5/8"	BPM5	2961010C	---	---	20
	---	2961010CBC <sup>1</sup>	---	---	20
3/4"	BPM6	2961212C	---	---	15
	---	2961212CBC <sup>1</sup>	---	---	15
1"	BPM8	2961616C	---	---	10

<sup>1</sup> Brass cap on CBC parts

NOTE: For Tuff-Lite® hose menders in nylon and polypropylene see page 369

## Push-On Hose Barb Fittings

### Application

- Intended for use with Lok-On (push-on style) hose only

### Features

- No hose clamps or ferrules are needed for installation 
- Properly grips push-on hose only when pushed all the way in, with the cut end of the hose completely concealed by the plastic cap

### Lok-On Male Garden Hose Fittings

Hose I.D.	GHT Thread	Brass	
		Previous Part #	Part #
1/2"	3/4"	572-0812	5720812C
5/8"	3/4"	572-1012	5721012C
3/4"	3/4"	572-1212	5721212C

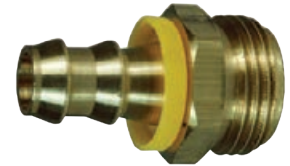

### Lok-On Female Swivel Garden Hose Fittings

Hose I.D.	GHT Thread	Brass	
		Previous Part #	Part #
1/2"	3/4"	574-0812	5740812C
5/8"	3/4"	574-1012	5741012C
3/4"	3/4"	574-1212	5741212C



### Lok-On Garden Hose Fitting Sets

#### Feature

- Washer included, part # 5911212W on page 412

Hose I.D.	GHT Thread	Brass	
		Previous Part #	Part #
1/2"	3/4"	575-0808	5750808K
5/8"	3/4"	575-1010	5751010K
3/4"	3/4"	575-1212	5751212K



### SAE Thread Size to UNF Thread Size Interchange

SAE Thread Number	SAE Tube O.D.	UNF Thread Size	SAE Thread Number	SAE Tube O.D.	UNF Thread Size
02	1/8"	5/16" - 24	07	7/16"	11/16" - 24
03	3/16"	3/8" - 24	08	1/2"	3/4" - 16
04	1/4"	7/16" - 20	10	5/8"	7/8" - 14
05	5/16"	1/2" - 20	12	3/4"	1-1/16" - 14
06	3/8"	5/8" - 18	---	---	---

### Male 45° SAE Swivel x Hose Barb

Hose I.D.	Tube O.D.	Male UNF	Brass		Pkg Qty
			Previous Part #	Part #	
1/4"	1/4"	7/16"-20	282-0407	2820407C	100
			---	2820407CBC <sup>2</sup>	100
	5/16"	1/2"-20	282-0408	2820408C	100
3/8"	3/8"	5/8"-18 <sup>1</sup>	---	2820408CBC <sup>2</sup>	100
			282-0610	2820610C	50
	---	2820610CBC <sup>2</sup>	100		
1/2"	1/2"	3/4"-16	282-0812	2820812C	50
			---	2820812CBC <sup>2</sup>	50
5/8"	5/8"	7/8"-14	282-1014	2821014C	25
			---	2821014CBC <sup>2</sup>	25
3/4"	3/4"	1-1/16"-14 <sup>1</sup>	282-1217	2821217C	25
			---	2821217CBC <sup>2</sup>	25



brass cap

<sup>1</sup> Notch in nut for SAE identification

<sup>2</sup> Brass cap on CBC parts

### Push-On Hose Barb Fittings

**Application**

- Intended for use with Lok-On (push-on style) hose only



**Features**

- No hose clamps or ferrules are needed for installation
- Properly grips push-on hose only when pushed all the way in, with the cut end of the hose completely concealed by the plastic cap

#### Female 45° SAE Swivel x Hose Barb

**Features**

- Notch in nut for SAE identification
- SAE thread size to UNF thread size interchange chart on previous page



brass cap

Hose I.D.	Tube O.D.	Female UNF	Brass		Pkg Qty
			Previous Part #	Part #	
1/4"	3/8"	5/8"-18	284-0410	2840410C	50
			---	2840410CBC <sup>1</sup>	
5/16"	3/8"	5/8"-18	284-0510	2840510C	50
3/8"	3/8"	5/8"-18	284-0610	2840610C	50
			---	2840610CBC <sup>1</sup>	
3/4"	3/4"	1-1/16"-14	284-1217	2841217C	25
			---	2841217CBC <sup>1</sup>	

<sup>1</sup> Brass cap on CBC parts

#### JIC Thread Size to UNF Thread Size Interchange

JIC Thread Number	JIC Tube O.D.	UNF Thread Size	JIC Thread Number	JIC Tube O.D.	UNF Thread Size
02	1/8"	5/16" - 24	12	3/4"	1-1/16" - 12
03	3/16"	3/8" - 24	14	7/8"	1-3/16" - 12
04	1/4"	7/16" - 20	16	1"	1-5/16" - 12
05	5/16"	1/2" - 20	20	1-1/4"	1-5/8" - 12
06	3/8"	9/16" - 18	24	1-1/2"	1-7/8" - 12
08	1/2"	3/4" - 16	28	1-3/4"	2-1/4" - 12
10	5/8"	7/8" - 14	32	2"	2-1/2" - 12

#### Male 37° JIC x Hose Barb



brass cap

Hose I.D.	Tube O.D.	Male UNF	Brass		Pkg Qty
			Previous Part #	Part #	
1/4"	1/4"	7/16"-20	286-0407	2860407C	100
	5/16"	1/2"-20	---	2860407CBC <sup>2</sup>	
			3/8"	9/16"-18	286-0408
3/8"	3/8"	9/16"-18	286-0409	2860409C	100
			---	2860409CBC <sup>2</sup>	
			286-0609	2860609C	50
---	2860609CBC <sup>2</sup>				
1/2"	1/2"	3/4"-16	286-0812	2860812C	25
			---	2860812CBC <sup>2</sup>	
5/8"	5/8"	7/8"-14	286-1014	2861014C	25
			---	2861014CBC <sup>2</sup>	
3/4"	3/4"	1-1/16"-12	286-1217	2861217C <sup>1</sup>	10
			---	2861217CBC <sup>1,2</sup>	

<sup>1</sup> UN Thread

<sup>2</sup> Brass cap on CBC parts

### Push-On Hose Barb Fittings

**Application**

- Intended for use with Lok-On (push-on style) hose only

**Features**

- No hose clamps or ferrules are needed for installation
- Properly grips push-on hose only when pushed all the way in, with the cut end of the hose completely concealed by the plastic cap

**Female 45° SAE/37° JIC Swivel x Hose Barb**

Hose I.D.	Tube O.D.	Female UNF	Brass			Lead-Free Brass <sup>1</sup> Part #
			Previous Part #	Part #	Pkg Qty	
1/4"	1/4"	7/16"-20	287-0407	2870407C	100	2870407CLF
			---	2870407CBC <sup>2</sup>	100	---
1/4"	5/16"	1/2"-20	287-0408	2870408C	100	---
			---	2870408CBC <sup>2</sup>	100	---
3/8"	5/16"	1/2"-20	287-0608	2870608C	25	---
	1/2"	3/4"-16	287-0612	2870612C	25	---
---			2870612CBC <sup>2</sup>	25	---	
1/2"	1/2"	3/4"-16	287-0812	2870812C	25	---
			---	2870812CBC <sup>2</sup>	25	---
1/2"	5/8"	7/8"-14	287-0814	2870814C	25	---
			---	2870814CBC <sup>2</sup>	25	---
5/8"	5/8"	7/8"-14	287-1014	2871014C	25	---
			---	2871014CBC <sup>2</sup>	25	---
3/4"	5/8"	7/8"-14	287-1214	2871214C	25	---
			---	2871214CBC <sup>2</sup>	25	---



plastic cap



brass cap



stainless steel

Hose I.D.	Tube O.D.	Female UNF	303 Stainless Steel	
			Previous Part #	Part #
1/4"	1/4"	7/16"-20	287-0407SS	2870407SS
1/2"	1/2"	3/4"-16	287-0812SS	2870812SS

<sup>1</sup> NSF®/ANSI 61 certified Lead-Free Brass <=0.25% lead, Alloy C2745

<sup>2</sup> Brass cap on CBC parts

**Female 37° JIC Swivel x Hose Barb**

Hose I.D.	Tube O.D.	Female UNF	Brass		Pkg Qty
			Previous Part #	Part #	
1/4"	3/8"	9/16"-18	288-0409	2880409C	50
			---	2880409CBC <sup>1</sup>	50
5/16"	3/8"	9/16"-18	288-0509	2880509C	50
			288-0609	2880609C	50
3/8"	3/8"	9/16"-18	---	2880609CBC <sup>1</sup>	100
			288-0809	2880809C	25
1/2"	3/8"	9/16"-18	288-1217	2881217C	10
			---	2881217CBC <sup>1</sup>	10
1"	1"	1-5/16"-12 <sup>2</sup>	288-1621	2881621C	10
			---	2881621C	10



brass



303 stainless steel

<sup>1</sup> Brass cap on CBC parts

Hose I.D.	Tube O.D.	Female UNF	303 Stainless Steel	
			Previous Part #	Part #
3/8"	3/8"	9/16"-18	288-0609SS	2880609SS
3/4"	3/4"	1-1/16"-12 <sup>2</sup>	288-1217SS	2881217SS
1"	1"	1-5/16"-12 <sup>2</sup>	288-1621SS	2881621SS

<sup>2</sup> UN Thread

**Female 37° JIC / 45° SAE Swivel x 90° Elbow**

Hose I.D.	Tube O.D.	Female UNF	Plated Steel		Pkg Qty
			Previous Part #	Part #	
1/4"	1/4"	7/16"-20	289-0407	2890407C <sup>2</sup>	25
			289-0407SAE	2890407CSAE <sup>1</sup>	25
3/8"	3/8"	9/16"-18	289-0609	2890609C <sup>2</sup>	25
		5/8"-18	289-0610SAE	2890610CSAE <sup>1</sup>	25
1/2"	1/2"	3/4"-16	289-0812	2890812C <sup>2</sup>	10
		1-1/16"-12 <sup>3</sup>	289-1217	2891217C <sup>2</sup>	5



<sup>1</sup> Notch in nut for SAE identification

<sup>2</sup> JIC only, may substitute dual angle

<sup>3</sup> UN thread

### Push-On Hose Barb Fittings

**Application**

- Intended for use with Lok-On (push-on style) hose only

**Features**

- No hose clamps or ferrules are needed for installation
- Properly grips push-on hose only when pushed all the way in, with the cut end of the hose completely concealed by the plastic cap



**Male SAE Inverted Flare Swivel x Hose Barb**

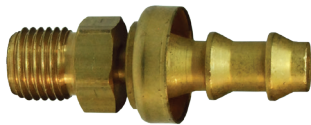

brass cap

Hose I.D.	Tube O.D.	Male UNF	Brass		Pkg Qty
			Previous Part #	Part #	
1/4"	3/16"	3/8"-24	290-0406	2900406C	100
			---	2900406CBC <sup>2</sup>	100
	1/4"	7/16"-24 <sup>1</sup>	290-0407	2900407C	100
			---	2900407CBC <sup>2</sup>	100
5/16"	5/16"	1/2"-20	290-0408	2900408C	100
			---	2900408CBC <sup>2</sup>	100
	3/8"	5/8"-18	290-0508	2900508C	50
			290-0510	2900510C	50
3/8"	5/16"	1/2"-20	290-0608	2900608C	100
			---	2900608CBC <sup>2</sup>	100
	3/8"	5/8"-18	290-0610	2900610C	50
			---	2900610CBC <sup>2</sup>	50
1/2"	1/2"	3/4"-18 <sup>1</sup>	290-0812	2900812C	50
			---	2900812CBC <sup>2</sup>	50
5/8"	5/8"	7/8"-18 <sup>1</sup>	290-1014	2901014C	25
			---	2901014CBC <sup>2</sup>	25

<sup>1</sup> UNS thread

<sup>2</sup> Brass cap on CBC parts

**Female SAE Inverted Flare Rigid x Hose Barb**



Hose I.D.	Tube O.D.	Female UNF	Brass		Pkg Qty
			Previous Part #	Part #	
1/4"	3/16"	3/8"-24	292-0406	2920406C	100
			---	2920406CBC <sup>2</sup>	100
	1/4"	7/16"-24 <sup>1</sup>	292-0407	2920407C	100
			---	2920407CBC <sup>2</sup>	100
5/16"	5/16"	1/2"-20	292-0408	2920408C	100
			---	2920408CBC <sup>2</sup>	100
	3/8"	5/8"-18	292-0508	2920508C	100
			292-0608	2920608C	100
3/8"	5/16"	1/2"-20	---	2920608CBC <sup>2</sup>	100
			292-0610	2920610C	50
	3/8"	5/8"-18	---	2920610CBC <sup>2</sup>	50
			292-0812	2920812C	25
1/2"	1/2"	3/4"-18 <sup>1</sup>	---	2920812CBC <sup>2</sup>	25

<sup>1</sup> UNS Thread

<sup>2</sup> Brass cap on CBC parts

**Rigid Tube x Hose Barb**



Hose I.D.	Tube O.D.	Brass		303 Stainless Steel		Pkg Qty	
		Previous Part #	Part #	Previous Part #	Part #		
1/4"	3/16"	294-0403	2940403C	---	---	100	
		---	2940403CBC <sup>1</sup>	---	---	100	
	1/4"	5/16"	294-0404	2940404C	294-0404SS	2940404SS	100
			---	2940404CBC <sup>1</sup>	---	---	100
3/8"	3/8"	294-0405	2940405C	---	---	100	
		---	2940405CBC <sup>1</sup>	---	---	100	
	3/8"	3/8"	294-0606	2940606C	294-0606SS	2940606SS	50
			---	2940606CBC <sup>1</sup>	---	---	50
1/2"	1/2"	294-0808	2940808C	294-0808SS	2940808SS	50	
		---	2940808CBC <sup>1</sup>	---	---	50	
5/8"	5/8"	294-1010	2941010C	---	---	25	
		---	2941010CBC <sup>1</sup>	---	---	25	
3/4"	3/4"	294-1212	2941212C	294-1212SS	2941212SS	25	

<sup>1</sup> Brass cap on CBC parts

### Push-On Fittings Tool

**Size**

- Overall size is 13-1/2" long x 2-3/8" wide x 7" height

**Features**

- Cuts push-on style hose and inserts the fitting
- Built-in cutter slices through 1/4" - 3/4" I.D. reinforced push-on hose without fraying
- Clamp hose into tools vice and apply light pressure on handle to drive in the fitting

**Specification**

- Tool has four 7/16" diameter mounting holes for bench mounting

**Installation Instructions**

1. To cut your hose, retract the handle, place the hose in the cutter area and pull the handle.
2. After cutting the hose to the desired length, place the hose under the cam handle locking it in place with the hose end aligned with the appropriate mark on the label.
3. Place the barbed end of the fitting against the end of the hose and then pull the handle forward to complete the installation.



Size	Part #
1/4" - 3/4"	270AT

**!** Caution: Push-on fittings will properly grip push-on hose only when pushed all the way in, with the cut end of the hose completely concealed by the plastic cap.

### Hose Assembly Tool

**Application**

- Installs 1/4", 5/16", and 3/8" hose fittings

**Features**

- Lightweight, portable, comfortable cushioned grip
- Economical



Part #
HHCI

### Yellow Lok-on Caps

**Application**

- Intended for use with Lok-On (push-on style) hose only

**Features**

- No hose clamps or ferrules are needed for installation
- Properly grips push-on hose only when pushed all the way in, with the cut end of the hose completely concealed by the plastic cap



Hose I.D.	Plastic Part #	Pkg Qty
1/4"	2720400W	25
5/16"	2720500W	25
3/8"	2720600W	25
1/2"	2720800W	25
5/8"	2721000W	25
3/4"	2721200W	25
1"	2721600W	5



NOTE: Sold in package quantities only.

Reusable Fittings

**⚠ WARNING**

Except as specifically noted as to a specific fitting, NO hose fittings manufactured and/or sold by any Dixon® company can be safely used in life dependency applications such as diving, for oxygen, air, or other breathing applications. Our fittings are NOT designed and NOT recommended for such use and should NOT BE USED for that purpose. Use of non-approved hose fittings in such applications can result in death or grave personal injuries.

**Application**

- Recommended for low pressure air hose

**Features**

- Durable, easily repaired hose connection
- Caution: check hose O.D. and I.D. accurately before ordering

**Specification**

- Maximum working pressure: 250 PSI at ambient temperature 70°F (21°C)



**Male Stem and Ferrule Set - Unassembled**

Hose I.D.	Hose O.D.	Male NPTF	Brass		Pkg Qty	
			Previous Part #	Part #		
1/4"	1/2"	1/8"	BN21RU50	1834082K	100	
	9/16"		BN21RU56	1834092K	100	
	5/8"		BN21RU62	1834102K	100	
	1/4"	1/2"	1/4"	BN22RU50	1834084K	50
		9/16"		BN22RU56	1834094K	50
		5/8"		BN22RU62	1834104K	50
		1/2"		BN23RU50	1834086K	50
5/16"	9/16"	3/8"	BN23RU56	1834096K	50	
	5/8"		BN23RU62	1834106K	50	
	1/2"		BN252RU56	1835094K	50	
	3/8"	5/8"	1/4"	BN252RU62	1835104K	50
		11/16"		BN252RU68	1835114K	50
		9/16"		BN253RU56	1835096K	50
		5/8"		BN253RU62	1835106K	50
		11/16"		BN253RU68	1835116K	50
		5/8"		BN32RU62	1836104K	50
		11/16"		BN32RU68	1836114K	50
1/2"	3/4"	1/4"	BN32RU75	1836124K	50	
	5/8"		BN33RU62	1836106K	50	
	11/16"		BN33RU68	1836116K	50	
	3/4"	3/8"	BN33RU75	1836126K	50	
	5/8"		BN34RU62	1836108K	50	
	11/16"		BN34RU68	1836118K	50	
	3/4"		BN34RU75	1836128K	50	
	7/8"		BN42RU87	1838144K	25	
	15/16"		BN42RU93	1838154K	25	
	1"		BN42RU99	1838164K	25	
3/8"	7/8"	1/4"	BN43RU87	1838146K	25	
	15/16"		BN43RU93	1838156K	25	
	1"		BN43RU99	1838166K	25	
	7/8"		BN44RU87	1838148K	20	
	15/16"		BN44RU93	1838158K	20	
	1"		BN44RU99	1838168K	20	



Hose I.D.	Hose O.D.	Male NPT	303 Stainless Steel		Pkg Qty	
			Previous Part #	Part #		
1/4"	1/2"	1/8"	BN21RU50SS	1834082KSS	100	
	9/16"		BN21RU56SS	1834092KSS	100	
	5/8"		BN21RU62SS	1834102KSS	100	
	1/4"	1/2"	1/4"	BN22RU50SS	1834084KSS	50
		9/16"		BN22RU56SS	1834094KSS	50
		5/8"		BN22RU62SS	1834104KSS	50
		1/2"		BN252RU56SS	1835094KSS	50
5/16"	5/8"	1/4"	BN252RU62SS	1835104KSS	50	
	9/16"		BN32RU62SS	1836104KSS	50	
	11/16"		BN32RU68SS	1836114KSS	50	
	3/4"		BN32RU75SS	1836124KSS	50	
	5/8"		BN33RU62SS	1836106KSS	50	
	11/16"		BN33RU68SS	1836116KSS	50	
	3/4"		3/8"	BN33RU75SS	1836126KSS	50
	7/8"			BN43RU87SS	1838146KSS	25
	15/16"			BN43RU93SS	1838156KSS	25
	7/8"			BN44RU87SS	1838148KSS	20
15/16"	BN44RU93SS	1838158KSS		20		





Reusable Fittings

**⚠ WARNING**

Except as specifically noted as to a specific fitting, NO hose fittings manufactured and/or sold by any Dixon® company can be safely used in life dependency applications such as diving, for oxygen, air, or other breathing applications. Our fittings are NOT designed and NOT recommended for such use and should NOT BE USED for that purpose. Use of non-approved hose fittings in such applications can result in death or grave personal injuries.

Swivel Stems

Hose I.D.	Female NPSM	Brass Part #	Optional Qty
1/4"	1/4"-18	1840404A	50
	3/8"-18	1840406A	50
5/16"	1/4"-18	1840504A	50
3/8"	1/4"-18	1840604A	50
	3/8"-18	1840606A	50
1/2"	1/2"-14	1840808A	25

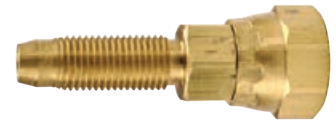

Female Swivel Stem and Ferrule Set - Unassembled

Hose I.D.	Hose O.D.	Female NPSM	Brass		Optional Qty
			Previous Part #	Part #	
1/4"	1/2"	1/4"	185-4084	1854084K	50
	9/16"		185-4094	1854094K	50
	5/8"		185-4104	1854104K	50
	1/2"	3/8"	185-4086	1854086K	50
	9/16"		185-4096	1854096K	50
	5/8"		185-4106	1854106K	50
5/16"	9/16"	1/4"	185-5094	1855094K	50
	5/8"		185-5104	1855104K	50
	11/16"		185-5114	1855114K	50
3/8"	5/8"	1/4"	185-6104	1856104K	50
	11/16"		185-6114	1856114K	50
	3/4"		185-6124	1856124K	50
	5/8"	3/8"	185-6106	1856106K	50
	11/16"		185-6116	1856116K	50
	3/4"		185-6126	1856126K	50
1/2"	7/8"	1/2"	185-8148	1858148K	20
	15/16"		185-8158	1858158K	20
	1"		185-8168	1858168K	20



Splicer Stems

Hose I.D.	Brass Part #	Optional Qty
1/4"	1860404S	100
3/8"	1860606S	50



Hose Splicers - Unassembled

Hose I.D.	Hose O.D.	Brass		Optional Qty
		Previous Part #	Part #	
1/4"	1/2"	187-0408	1870408K	50
	9/16"	187-0409	1870409K	50
	5/8"	187-0410	1870410K	50
3/8"	5/8"	187-0610	1870610K	25
	11/16"	187-0611	1870611K	25
	3/4"	187-0612	1870612K	25



Reusable Fittings



Except as specifically noted as to a specific fitting, NO hose fittings manufactured and/or sold by any Dixon® company can be safely used in life dependency applications such as diving, for oxygen, air, or other breathing applications. Our fittings are NOT designed and NOT recommended for such use and should NOT BE USED for that purpose. Use of non-approved hose fittings in such applications can result in death or grave personal injuries.

Ferrules



Hose I.D.	Hose O.D.	Brass Part #	303 Stainless Steel Part #	Opt Qty
1/4"	1/2"	1800408F	1800408FSS	100
	9/16"	1800409F	1800409FSS	50
	5/8"	1800410F	1800410FSS	50
5/16"	9/16"	1800509F	1800509FSS	100
	5/8"	1800510F	1800510FSS	50
	11/16"	1800511F	---	50
3/8"	5/8"	1800610F	1800610FSS	50
	11/16"	1800611F	1800611FSS	50
	3/4"	1800612F	1800612FSS	50
1/2"	7/8"	1800814F	1800814FSS	25
	15/16"	1800815F	1800815FSS	25
	1"	1800816F	---	20

Male Stems

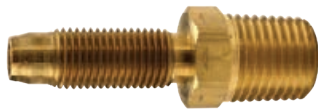

Hose I.D.	Male NPTF Thread <sup>1</sup>	Brass Part #	303 Stainless Steel <sup>1</sup> Part #	Opt Qty
1/4"	1/8"	1820402S	1820402SS	100
	1/4"	1820404S	1820404SS	100
	3/8"	1820406S	---	50
5/16"	1/4"	1820504S	1820504SS	50
	3/8"	1820506S	---	50
3/8"	1/4"	1820604S	1820604SS	100
	3/8"	1820606S	1820606SS	50
	1/2"	1820608S	---	25
1/2"	1/4"	1820804S	---	50
	3/8"	1820806S	1820806SS	50
	1/2"	1820808S	1820808SS	25

<sup>1</sup> Stainless steel parts have NPT threads

## Pipe Fittings

### Reducer Couplings Adapters

**Feature**

- Ref SAE 130138

Female NPTF	Brass		Optional Qty	Lead-Free Brass <sup>1,2</sup> Part #
	Previous Part #	Part #		
1/4" x 1/8"	RC2F1F	3770402C	50	---
3/8" x 1/8"	RC3F1F	3770602C	50	---
3/8" x 1/4"	RC3F2F	3770604C	50	---
1/2" x 1/4"	RC4F2F	3770804C	25	---
1/2" x 3/8"	RC4F3F	3770806C	10	3770806CLF
3/4" x 3/8"	RC6F3F	3771206C	10	---
3/4" x 1/2"	RC6F4F	3771208C	10	3771208CLF



<sup>1</sup> NSF®/ANSI 61 certified Lead-Free Brass <=0.25% lead, Alloy C2745

<sup>2</sup> Conforms To: Safe Water Drinking Act (SWDA) of Jan. 4, 2014; California AB1953; RoHS Compliant

### Female Hex Couplings

**Feature**

- Ref SAE 130138

NPTF	Brass		Pkg Qty	Lead-Free Brass <sup>1,2</sup> Part #
	Previous Part #	Part #		
1/8" x 1/8"	BA1F1F	3710202C	25	3710202CLF
1/4" x 1/4"	BA2F2F	3710404C	25	3710404CLF
3/8" x 3/8"	BA3F3F	3710606C	25	3710606CLF
1/2" x 1/2"	BA4F4F	3710808C	25	3710808CLF
3/4" x 3/4"	BA6F6F	3711212C	10	---



<sup>1</sup> NSF®/ANSI 61 certified Lead-Free Brass <=0.25% lead, Alloy C2745

<sup>2</sup> Conforms To: Safe Water Drinking Act (SWDA) of Jan. 4, 2014; California AB1953; RoHS Compliant

### Reducer Hex Bushings

**Feature**

- Ref SAE 130140

Male NPTF	Female NPTF	Brass		Optional Qty	Lead-Free Brass <sup>2,3</sup> Part #
		Previous Part #	Part #		
1/4"	1/8"	HB1F2M	3730402C	100	3730402CLF
	1/8"	HB1F3M	3730602C	100	---
3/8"	1/4"	HB2F3M	3730604C	100	3730604CLF
	1/8"	HB1F4M	3730802C	25	---
1/2"	1/4"	HB2F4M	3730804C	50	3730804CLF
	3/8"	HB3F4M	3730806C	50	3730806CLF
	1/8"	HB1F6M	3731202C <sup>1</sup>	25	---
3/4"	1/4"	HB2F6M	3731204C	25	---
	3/8"	HB3F6M	3731206C	25	---
	1/2"	HB4F6M	3731208C	25	3731208CLF
	1/4"	HB2F8M	3731604C <sup>1</sup>	10	---
1"	3/8"	HB3F8M	3731606C <sup>1</sup>	10	---
	1/2"	HB4F8M	3731608C	10	---
	3/4"	HB6F8M	3731612C	10	---



<sup>1</sup> SAE does not provide a standard for these sizes

<sup>2</sup> NSF®/ANSI 61 certified Lead-Free Brass <=0.25% lead, Alloy C2745

<sup>3</sup> Conforms To: Safe Water Drinking Act (SWDA) of Jan. 4, 2014; California AB1953; RoHS Compliant

## Pipe Fittings

### Female NPTF x Male NPTF Adapters

**Feature**

- Ref SAE 130139



Female NPTF	Male NPTF	Brass		Optional Qty	Lead-Free Brass <sup>1,2</sup> Part #
		Previous Part #	Part #		
1/8"	1/8"	RA1F1M	3750202C	100	---
1/4"	1/8"	RA2F1M	3750402C	50	3750402CLF
	1/4"	RA2F2M	3750404C	50	3750404CLF
3/8"	1/8"	RA3F1M	3750602C	50	---
	1/4"	RA3F2M	3750604C	50	3750604CLF
	3/8"	RA3F3M	3750606C	50	---
1/2"	1/4"	RA4F2M	3750804C	25	---
	3/8"	RA4F3M	3750806C	25	---
	1/2"	RA4F4M	3750808C	25	3750808CLF
3/4"	3/8"	RA6F3M	3751206C	10	---
	1/2"	RA6F4M	3751208C	10	---
	3/4"	RA6F6M	3751212C	10	3751212CLF

<sup>1</sup> NSF®/ANSI 61 certified Lead-Free Brass <=0.25% lead, Alloy C2745

<sup>2</sup> Conforms To: Safe Water Drinking Act (SWDA) of Jan. 4, 2014; California AB1953; RoHS Compliant

### Female NPTF x Male NPSM Adapters



Female NPTF	Male NPSM	Brass		Optional Qty
		Previous Part #	Part #	
1/4"	1/4"	174-0404	1740404C	100
3/8"	3/8"	174-0606	1740606C	50
1/2"	1/2"	174-0808	1740808C	50

NOTE: For additional information on pipe dimensions please reference dixonvalve.com.

### Close Pipe Nipples



NPT	Brass		Optional Qty	Lead-Free Brass <sup>1,2</sup> Part #
	Previous Part #	Part #		
1/8"	165-0202	1650202C	50	1650202CLF
1/4"	165-0404	1650404C	50	1650404CLF
3/8"	165-0606	1650606C	100	1650606CLF
1/2"	165-0808	1650808C	25	1650808CLF
3/4"	165-1212	1651212C	25	1651212CLF
1"	165-1616	1651616C	25	---
1-1/2"	---	CN150B	5	---
2"	---	CN200B	5	---
3"	---	CN300B	5	---

<sup>1</sup> Lead-free brass <=0.25% lead; Alloy CA2745; Alloy C46400

<sup>2</sup> Conforms To: Safe Water Drinking Act (SWDA) of Jan. 4, 2014; California AB1953; RoHS Compliant

NOTE: For additional information on pipe dimensions please reference dixonvalve.com.

## Pipe Fittings

### Long Pipe Nipples

**Feature**

- Carbon steel and stainless steel nipples are available on page 927

NPT	Length	Brass		Optional Qty	Lead-Free Brass <sup>1,2</sup> Part #
		Previous Part #	Part #		
1/8"	1-1/2"	166-0215	1660215C	25	---
	2"	166-0220	1660220C	25	---
	2-1/2"	166-0225	1660225C	25	---
	3"	166-0230	1660230C	25	---
	3-1/2"	166-0235	1660235C	10	---
	4"	166-0240	1660240C	10	---
1/4"	1-1/2"	166-0415	1660415C	25	1660415CLF
	2"	166-0420	1660420C	25	---
	2-1/2"	166-0425	1660425C	25	---
	3"	166-0430	1660430C	25	1660430CLF
	3-1/2"	166-0435	1660435C	10	---
	4"	166-0440	1660440C	10	1660440CLF
3/8"	1-1/2"	166-0615	1660615C	25	---
	2"	166-0620	1660620C	25	---
	2-1/2"	166-0625	1660625C	10	---
	3"	166-0630	1660630C	10	---
	3-1/2"	166-0635	1660635C	10	---
	4"	166-0640	1660640C	5	---
1/2"	1-1/2"	166-0815	1660815C	10	---
	2"	166-0820	1660820C	10	---
	2-1/2"	166-0825	1660825C	10	---
	3"	166-0830	1660830C	10	---
	3-1/2"	166-0835	1660835C	10	---
	4"	166-0840	1660840C	5	---
3/4"	2"	166-1220	1661220C	5	---
	2-1/2"	166-1225	1661225C	5	---
	3"	166-1230	1661230C	5	---
	3-1/2"	166-1235	1661235C	5	---
1"	2"	---	TN100X2B	---	---
	3"	---	TN100X3B	---	---
	4"	---	TN100X4B	---	---
1-1/2"	2"	---	TN150X2B	---	---
	3"	---	TN150X3B	---	---
2"	3"	---	TN200X3B	---	---
	4"	---	TN200X4B	---	---
	6"	---	TN200X6B	---	---



<sup>1</sup> Lead-free brass <=0.25% lead; Alloy CA2745; Alloy C46400

<sup>2</sup> Conforms To: Safe Water Drinking Act (SWDA) of Jan. 4, 2014; California AB1953; RoHS Compliant

### Hex Nipples

**Feature**

- Ref SAE 130137

NPTF	Brass		Optional Qty	Lead-Free Brass <sup>1,2</sup> Part #
	Previous Part #	Part #		
1/8" x 1/8"	BCN12	3700202C	100	3700202CLF
1/4" x 1/4"	BCN25	3700404C	100	3700404CLF
3/8" x 3/8"	BCN37	3700606C	50	3700606CLF
1/2" x 1/2"	BCN50	3700808C	25	3700808CLF
3/4" x 3/4"	BCN75	3701212C	20	---
1" x 1"	BCN100	3701616C	10	---



<sup>1</sup> NSF®/ANSI 61 certified Lead-Free Brass <=0.25% lead, Alloy C2745

<sup>2</sup> Conforms To: Safe Water Drinking Act (SWDA) of Jan. 4, 2014; California AB1953; RoHS Compliant

Pipe Fittings

Reducer Hex Nipples

Feature

- Ref SAE 130137



Male NPTF	Brass		Optional Qty
	Previous Part #	Part #	
1/4" x 1/8"	HN2M1M	3790402C	100
3/8" x 1/8"	HN3M1M	3790602C	50
3/8" x 1/4"	HN3M2M	3790604C	50
1/2" x 1/4"	HN4M2M	3790804C	50
1/2" x 3/8"	HN4M3M	3790806C	50
3/4" x 1/2"	HN6M4M	3791208C	25

Ball Seat to Male Pipe Adapters

NPSM	NPTF	Brass		Optional Qty
		Previous Part #	Part #	
1/8"	1/8"	BSM11	1720202C	100
1/4"	1/8"	BSM21	1720402C	100
	1/4"	BSM22	1720404C	100
3/8"	1/4"	BSM32	1720604C	100
	3/8"	BSM33	1720606C	50
	1/2"	BSM34	1720608C	50
1/2"	3/8"	BSM43	1720806C	50
	1/2"	BSM44	1720808C	50
3/4"	3/4"	BSM66	1721212C	25



Male Unions

NPSM	NPSM	Brass		Pkg Qty
		Previous Part #	Part #	
1/8"	1/8"	176-0202	1760202C	100
1/4"	1/4"	176-0404	1760404C	100
3/8"	3/8"	176-0606	1760606C	100
1/2"	1/2"	176-0808	1760808C	50



90° Female Pipe Elbows

Feature

- Ref SAE 130238

Female NPTF	Extruded Brass		Optional Qty	Forged Lead-Free Brass <sup>1,2,3</sup> Part #
	Previous Part #	Part #		
1/8"	EL1F1F	3020202C	25	---
1/4"	EL2F2F	3020404C	25	---
3/8"	EL3F3F	3020606C	25	3020606CLF
1/2"	EL4F4F	3020808C <sup>4</sup>	25	3020808CLF
3/4"	EL6F6F	3021212C <sup>4</sup>	10	---



brass



lead-free brass

<sup>1</sup> Lead-free brass <=0.25% lead; Alloy CA2745; Alloy C46400

<sup>2</sup> Conforms To: Safe Water Drinking Act (SWDA) of Jan. 4, 2014; California AB1953; RoHS Compliant

<sup>3</sup> NPT thread

<sup>4</sup> Product shape may vary

NOTE: For additional information on pipe dimensions please reference [dixonvalve.com](http://dixonvalve.com).

**Pipe Fittings**  
**90° Street Elbows**

**Feature**

- Ref SAE 130239

Female NPTF	Male NPTF	Extruded Brass		Optional Qty	Forged Lead-Free Brass <sup>1, 2, 3</sup> Part #
		Previous Part #	Part #		
1/8"	1/8"	SE1F1M	3040202C <sup>4</sup>	25	3040202CLF
1/4"	1/8"	SE2F1M	3040402C	25	---
	1/4"	SE2F2M	3040404C <sup>4</sup>	25	3040404CLF
3/8"	1/4"	SE3F2M	3040604C	25	---
	3/8"	SE3F3M	3040606C <sup>4</sup>	25	3040606CLF
1/2"	3/8"	SE4F3M	3040806C	25	---
	1/2"	SE4F4M	3040808C <sup>4</sup>	25	3040808CLF
3/4"	1/2"	SE6F4M	3041208C	25	---
	3/4"	SE6F6M	3041212C <sup>4</sup>	10	---

<sup>1</sup> Lead-free brass <=0.25% lead; Alloy CA2745; Alloy C46400

<sup>2</sup> Conforms To: Safe Water Drinking Act (SWDA) of Jan. 4, 2014; California AB1953; RoHS Compliant

<sup>3</sup> NPT thread

<sup>4</sup> Product shape may vary



brass



lead-free brass

**90° Male Pipe Elbows**

Male NPTF	Forged Brass		Optional Qty
	Previous Part #	Part #	
1/8"	169-0202	1690202C	25
1/4"	169-0404	1690404C	25
3/8"	169-0606	1690606C	25
1/2"	169-0808	1690808C	25



**NPT Threaded 45 Elbows**

**Feature**

- Ref SAE 130339

Female NPTF	Male NPTF	Extruded Brass		Optional Qty
		Previous Part #	Part #	
1/8"	1/8"	306-0202	3060202C	25
1/4"	1/4"	306-0404	3060404C	25
3/8"	3/8"	306-0606	3060606C	25
1/2"	1/2"	306-0808	3060808C	25
3/4"	3/4"	306-1212	3061212C	10



**Female Tees**

**Feature**

- Ref SAE 130438

NPTF Thread	Extruded Brass		Optional Qty	Forged Lead-Free Brass <sup>1, 2, 3</sup> Part #
	Previous Part #	Part #		
1/8"	322-0202	3220202C <sup>4</sup>	25	3220202CLF
1/4"	322-0404	3220404C <sup>4</sup>	25	3220404CLF
3/8"	322-0606	3220606C	25	3220606CLF
1/2"	322-0808	3220808C	25	3220808CLF
3/4"	322-1212	3221212C	10	---



brass



lead-free brass

<sup>1</sup> Lead-free brass <=0.25% lead; Alloy CA2745; Alloy C46400

<sup>2</sup> Conforms To: Safe Water Drinking Act (SWDA) of Jan. 4, 2014; California AB1953; RoHS Compliant

<sup>3</sup> NPT thread

<sup>4</sup> Product shape may vary

NOTE: For additional information on pipe dimensions please reference [dixonvalve.com](http://dixonvalve.com).

**Pipe Fittings**  
**Street Tees**

**Feature**

- Ref SAE 130424



Female NPTF	Male NPTF	Extruded Brass		Optional Qty	Lead-Free Brass <sup>1,2,3</sup> Part #
		Previous Part #	Part #		
1/8"	1/8"	326-0202	3260202C	25	---
1/4"	1/4"	326-0404	3260404C <sup>4</sup>	25	3260404CLF
3/8"	3/8"	326-0606	3260606C	25	---
1/2"	1/2"	326-0808	3260808C	25	---
3/4"	3/4"	326-1212	3261212C	10	---

<sup>1</sup> Lead-free brass <=0.25% lead; Alloy CA2745; Alloy C46400

<sup>2</sup> Conforms To: Safe Water Drinking Act (SWDA) of Jan. 4, 2014; California AB1953; RoHS Compliant

<sup>3</sup> NPT thread

<sup>4</sup> Product shape may vary

**Male Branch Tees**

**Feature**

- Ref SAE 130425



NPTF	Extruded Brass		Optional Qty
	Previous Part #	Part #	
1/8"	324-0202	3240202C	25
1/4"	324-0404	3240404C <sup>1</sup>	25
3/8"	324-0606	3240606C	25
1/2"	324-0808	3240808C	25
3/4"	324-1212	3241212C	10

<sup>1</sup> Product shape may vary

**Pipe Crosses**



Female NPTF	Extruded Brass		Optional Qty
	Previous Part #	Part #	
1/8"	228-0202	2280202C	25
1/4"	228-0404	2280404C	25
3/8"	228-0606	2280606C	25
1/2"	228-0808	2280808C	10
3/4"	228-1212	2281212C	10

NOTE: For additional information on pipe dimensions please reference [dixonvalve.com](http://dixonvalve.com).

**NPTF Pipe Caps**

**Feature**

- Lead-free per NSF/ANSI 372



Female NPTF	Optional Qty	Lead-Free Brass <sup>1,2</sup> Part #
1/8"	50	2130200CLF
1/4"	100	2130400CLF
3/8"	25	2130600CLF
1/2"	25	2130800CLF
3/4"	25	2131200CLF

<sup>1</sup> Lead-free Brass <= .25% lead, Alloy C2745

<sup>2</sup> Conforms To: Safe Water Drinking Act (SWDA) of Jan. 4, 2014; California AB1953; RoHS Compliant



## Pipe Fittings

### NPT Threaded Square Head Plugs

**Feature**

- Brass plugs are solid
- Lead-Free Brass per NSF/ANSI 372

Male NPF-SAE	Lead-Free Brass 260/270 Part #
1/8"	2110200C
1/4"	2110400C
3/8"	2110600C
1/2"	2110800C
3/4"	2111200C



### Hex Head Plugs

NPT	Brass		Pkg Qty	Lead-Free Brass <sup>1,2</sup> Part #
	Previous Part #	Part #		
1/8"	HHP1M	1630200C	50	1630200CLF
1/4"	HHP2M	1630400C	100	1630400CLF
3/8"	HHP3M	1630600C	25	---
1/2"	HHP4M	1630800C	25	---
3/4"	HHP6M	1631200C	25	---
1"	HHP8M	1631600C	10	---



<sup>1</sup> Lead-free brass <=0.25% lead; Alloy CA2745; Alloy C46400

<sup>2</sup> Conforms To: Safe Water Drinking Act (SWDA) of Jan. 4, 2014; California AB1953; RoHS Compliant

NOTE: Standard brass hex head plug is hollow; lead-free brass is solid

### Hex Socket Plugs

**Feature**

- Lead-free brass per NSF/ANSI 372

NPTF	Lead-Free Brass 260/270		Optional Qty
	Previous Part #	Part #	
1/8"	219-0200	2190200C	50
1/4"	219-0400	2190400C	100
3/8"	219-0600	2190600C	25
1/2"	219-0800	2190800C	25
3/4"	219-1200	2191200C	25



NOTE: For additional information on pipe dimensions please reference [dixonvalve.com](http://dixonvalve.com).

### Grease Whip Hose Assemblies

**Applicaton**

- For use with hand grease guns only

**Specifications**

- 1/8"-27 male NPT, solid base (0010260C)
- Working pressure: **3000 PSI**

**Features**

- One piece crimp couplings
- Add "S" to order carbon steel strain relief spring option

**Approval**

- US manufactured 3/16" I.D. hose - exceeds SAE 100R1-AT



Assembly Length	Brass		Strain Relief Option
	Previous Part #	Part #	
8"	GWH-0800	GWH0800	GWH0800S
12"	GWH-1200	GWH1200	GWH1200S
	---	GWH1200R <sup>1</sup>	---
18"	GWH-1800	GWH1800	GWH1800S
	---	GWH1800R <sup>1</sup>	---
24"	GWH-2400	GWH2400	GWH2400S
36"	GWH-3600	GWH3600	GWH3600S
48"	GWH-4800	GWH4800	GWH4800S
60"	GWH-6000	GWH6000	GWH6000S

<sup>1</sup> Retail packaging

### Grease Whip Hose Fittings

**Features**

- 0010055C, 0010260C, and 0010860C are designed to be crimped to 3/16" I.D. hose
- GWHC and GWHC-FF mate with Zerk fittings on the coupler side

#### Grease Hose Couplers

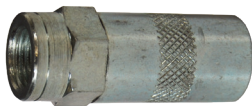

Description	Zinc Plated Steel		Optional Qty
	Previous Part #	Part	
1/8"-27 female NPT thread, grease hose coupler with ball check - valved shutoff	GWHC	GWHC	25
1/8"-27 female NPT thread, full flow grease hose coupler	---	GWHC-FF	25

NOTE: Add 'R' suffix to part number for retail pack option

#### Male NPT Thread - Chamfered Base



Description	Brass		Optional Qty
	Previous Part #	Part #	
1/8"-27 male NPT thread, drilled and chamfered base	001-0055	0010055C	100

#### Male NPT Thread - Solid Base

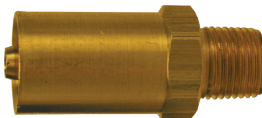

Description	Brass		Optional Qty
	Previous Part #	Part #	
1/8"-27 male NPT thread, solid base	001-0260	0010260C	100

#### Female NPT Thread

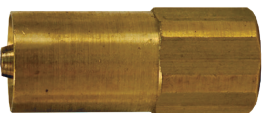

Description	Brass		Optional Qty
	Previous Part #	Part #	
1/8"-27 female NPT thread	001-0860	0010860C	100

### Grease Whip Fittings - Zerk

#### Straight

Thread	Description	Overall Length	Thread Length	Hex	Zinc Plated Steel Part #	Pkg Qty
1/8"-27 NPT	straight	.660"	.260"	.430	GWHZ000	100
1/4"-28 tapered SAE-LT	straight	.530"	.200"	.312	GWHZ400	100



#### 45°

Thread	Description	Overall Length	Thread Length	Hex	Zinc Plated Steel Part #	Pkg Qty
1/8"-27 NPT	45°	.860"	.280"	.430	GWHZ045	100
1/4"-28 tapered SAE-LT	45°	.800"	.200"	.375	GWHZ445	100



#### 90°

Thread	Description	Overall Length	Thread Length	Hex	Zinc Plated Steel Part #	Pkg Qty
1/8"-27 NPT	90°	.830"	.310"	.430	GWHZ090	100
1/4"-28 tapered SAE-LT	90°	1.20"	.200"	.375	GWHZ490	100



### Grease Whip Fittings - Zerk Retail Packaged

NOTE: All items sold in retail packets of 10: Order 1 for 1 retail pack of 10 pieces.

#### Straight

Thread	Description	Overall Length	Thread Length	Hex	Zinc Plated Steel Part #
1/8"-27 NPT	straight	.660"	.260"	.430	GWHZ000R
1/4"-28 tapered SAE-LT	straight	.530"	.200"	.312	GWHZ400R



#### 45°

Thread	Description	Overall Length	Thread Length	Hex	Zinc Plated Steel Part #
1/8"-27 NPT	45°	.860"	.280"	.430	GWHZ045R
1/4"-28 tapered SAE-LT	45°	.800"	.200"	.375	GWHZ445R



#### 90°

Thread	Description	Overall Length	Thread Length	Hex	Zinc Plated Steel Part #
1/8"-27 NPT	90°	.830"	.310"	.430	GWHZ090R
1/4"-28 tapered SAE-LT	90°	1.20"	.200"	.375	GWHZ490R



## Oxy-Acetylene Hose Couplings

### Acetylene Couplings

**Feature**

- Left-hand thread for acetylene line x hose shank

**Approval**

- Parts meet CGA-E-1 standards

**Specification**

- Maximum 200 PSI



Hose Size	Left UNF Thread	Hex	Brass		
			Previous Part #	CGA #	Part #
3/16"	3/8"-24	7/16"	OA69	021	1540306K
	9/16"-18	11/16"	OA70	023	1540309K
1/4"	9/16"-18	11/16"	OA71	023	1540409K
5/16"	9/16"-18	11/16"	OA72	023	1540509K
3/8"	9/16"-18	11/16"	OA73	023	1540609K

### Oxygen Couplings

**Feature**

- Right-hand thread for oxygen line x hose shank



Hose Size	Right UNF Thread	Hex	Brass		
			Previous Part #	CGA #	Part #
3/16"	3/8"-24	7/16"	OA59	020	1520306K
	9/16"-18	11/16"	OA60	022	1520309K
1/4"	9/16"-18	11/16"	OA61	022	1520409K
5/16"	9/16"-18	11/16"	OA62	022	1520509K
3/8"	9/16"-18	11/16"	OA63	022	1520609K

## Oxy-Acetylene Connecting Spuds

### Left-hand Thread x Left-hand Thread



Left UNF Thread	Hex	Brass		
		Previous Part #	CGA #	Part #
9/16"-18	11/16"	OA52	023	1580909C

### Right-hand Thread x Right-hand Thread



Right UNF Thread	Hex	Brass		
		Previous Part #	CGA #	Part #
9/16"-18	11/16"	OA50	022	1560909C

## Oxy-Acetylene Adapters

### Left-hand Thread x NPTF



Left UNF Thread	NPTF Thread	Hex	Brass		
			Previous Part #	CGA #	Part #
9/16"-18	1/8"	11/16"	158-0902	023	1580902C
	1/4"	11/16"	158-0904	023	1580904C
	3/8"	11/16"	158-0906	023	1580906C

### Right-hand Thread x NPTF

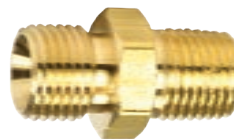

Right UNF Thread	NPTF Thread	Hex	Brass		
			Previous Part #	CGA #	Part #
9/16"-18	1/8"	11/16"	156-0902	022	1560902C
	1/4"	11/16"	156-0904	022	1560904C
	3/8"	11/16"	156-0906	022	1560906C

## Oxy-Acetylene Ferrules

**Feature**

- Sold in package quantities only



Inside Dimensions	Overall Length	Metal Gauge	Standard Ind. Part #	Brass Part #	Qty
.458" x 0.890"	15/32"	.019"	9116	BFO448	25
.474" x 0.943"	15/32"	.019"	9979	BFO474	25
.535" x 1.071"	3/4"	.024"	9940P	BFO535	25
.593" x 1.109"	3/4"	.024"	9593	BFO593	25
.700" x 1.325"	.719"	.025"	8337	BFO700	25

**Worm Gear Clamps ..... 460 - 465**

Dixon® HS and HSS styles .....460  
 Miniature MH and MAH styles .....460  
 Aero-Seal® style.....461  
 Marine grade .....461  
 Aero-Seal® style liner.....462  
 WaveSeal .....462  
 Constant torque .....463  
 HTM hi torque.....463  
 Assorted clamps .....464  
 Dixon worm gear clamp racks.....464  
 Quick release .....465  
 Make-A-Clamp kits .....465

**T-Bolt ..... 466 - 468**

TBC and STBC style T-bolt .....466  
 Heavy duty T-bolt.....467  
 Long T-bolt .....468

**Band ..... 469 - 476**

Center punch .....469  
     Pre-formed F-series .....469  
     Open end FO-series .....469  
 Universal pre-formed, K-series.....470  
 Dixon smooth I.D. ....471  
     Roll-over type .....471  
     Center punch .....471  
 Band and buckle.....472  
     Clamp buckles .....472  
     Strapping .....472  
     Set screw buckles .....472  
     Banding.....472  
 Band clamp tools ..... 473 - 474  
     Portable locking hand tool.....473  
     Intermediate hand tool.....473  
     Hand tool for 5/8" clamps.....473  
     Hand tool for 3/8" and 5/8" clamps.....473  
     Adapter for F100 tool .....473  
     Punching mallet .....474  
     Clamp cutter .....474  
 Clamping tool for band and buckles.....474  
     Band and buckle clamping tool .....474  
     Clamping tool adapter for 51960 tool .....474  
 Clamp safety caps .....474  
 Pinch-on single ear .....475  
 Pinch-on double ear .....475  
 Stepless® ear .....476  
 Clamp service kit.....476

**Band (cont.) ..... 469 - 476**

Standard jaw clamp tool.....476  
 Side jaw clamp tool.....476

**Bolted Clamps.....477 - 479**

Double bolt .....477  
     With saddles .....477  
 Single bolt.....478  
 Spiral clamps.....479  
     Clockwise.....479  
     Counter clockwise .....479



### Dixon® Worm Gear Clamps

**Size**

- Screw design: 5/16" slotted hex head

**Features**

- Four-piece construction
- Maximum recommended torque 50 in. lbs.
- All clamps sold 10 per box

**Materials**

- Band and housing: SAE 300-series stainless
- Screw: SAE 1018 case-hardened, hex-free chrome zinc-plated steel
- Band and housing: SAE 300-series stainless
- Screw: SAE 300-series stainless

**Approval**

- Clamp meets SAEJ1508 which supercedes Mil Spec WW-C-440B



style HSS

Band Width	Hose O.D.		Style HS Part #	Master Case Qty	Style HSS Part #	Master Case Qty
	from	to				
1/2"	7/16"	25/32"	HS6	200	HSS6	200
	1/2"	29/32"	HS8	200	HSS8	200
	9/16"	1-1/16"	HS10	500	HSS10	500
	11/16"	1-1/14"	HS12	500	HSS12	500
	13/16"	1-1/2"	HS16	500	HSS16	500
	13/16"	1-3/4"	HS20	500	HSS20	500
	1-1/16"	2"	HS24	500	HSS24	500
	1-5/16"	2-1/4"	HS28	500	HSS28	500
	1-9/16"	2-1/2"	HS32	500	HSS32	500
	1-13/16"	2-3/4"	HS36	500	HSS36	500
	2-1/16"	3"	HS40	200	HSS40	200
	2-5/16"	3-1/4"	HS44	200	HSS44	200
	2-9/16"	3-1/2"	HS48	200	HSS48	200
	2-13/16"	3-3/4"	HS52	200	HSS52	200
	3-1/16"	4"	HS56	200	HSS56	200
	9/16"	3-5/16"	4-1/4"	HS60	200	HSS60
3-9/16"		4-1/2"	HS64	200	HSS64	200
1-7/8"		5"	HS72	100	HSS72	100
2-1/2"		5-1/2"	HS80	100	HSS80	100
3-1/8"		6"	HS88	100	HSS88	100
3-5/8"		6-1/2"	HS96	100	HSS96	100
4-1/8"		7"	HS104	100	HSS104	100
5-5/8"		8-1/2"	HS128	100	HSS128	100
7-1/8"		10"	HS152	100	HSS152	100
9-3/8"		12-1/4"	HS188	100	HSS188	100
10-1/8"		13"	HS200	100	HSS200	100
10-7/8"		13-3/4"	HS212	100	HSS212	100
11-5/8"		14-1/2"	HS224	100	HSS224	100
12-3/8"		15-1/4"	HS236	100	HSS236	100
13-1/8"		16"	HS248	100	HSS248	100
17-1/8"		20"	HS312	100	HSS312	100

### Miniature Worm Gear Clamps

**Size**

- Screw design: 1/4" slotted hex head

**Features**

- Maximum recommended torque 15 in. lbs.
- All clamps sold 10 per box

**Materials**

- Band and housing: SAE 300-series stainless
- Screw: SAE 1018 case-hardened, hex-free chrome zinc-plated steel
- Band and housing: SAE 300-series stainless
- Screw: SAE 300-series stainless

**Approval**

- Meets SAE J1508



style MH

Band Width	Hose O.D.		Style MH Part #	Master Case Qty	Style MAH Part #	Master Case Qty
	from	to				
5/16"	7/32"	5/8"	MH4	500	MAH4	500
	7/16"	25/32"	MH6	500	MAH6	500
	1/2"	29/32"	MH8	200	MAH8	200
	9/16"	1-1/16"	MH10	200	MAH10	200
	11/16"	1-1/4"	MH12	200	MAH12	200
	15/16"	1-1/2"	MH16	200	MAH16	200
	1-3/16"	1-3/4"	MH20	200	MAH20	200

NOTE: Torque ratings correspond to the torque rating of the screw of the clamp and are not an indication of the working pressure of any hose assembly installed with this clamp

### Aero-Seal® Worm Gear Clamps

**Features**

- Four-piece construction
- Band slots designed for strength and smooth action
- Saddle interlocks into embossed band to form a true concentric circle
- Slotted hex head screw design
- Heat treated screws have buttress thread type
- Safety collar or thumb screw available on the style 200-series only
- Suggested installation torque 30-42 in. lbs.; maximum recommended torque 60 in. lbs.
- All clamps sold 10 per box
- Torque ratings correspond to the torque rating of the screw of the clamp and are not an indication of the working pressure of any hose assembly installed with this clamp

**Materials**

- Style 100
- Band and housing: 300 SS
  - Screw: plated carbon steel
- Style 200
- Band and housing: 300 SS
  - Screw: 410 stainless steel
- Style 300
- Band and housing: 300 SS
  - Screw: 305 stainless steel



Band Width	Hose O.D.		Style 100	Style 200	Style 300	Pkg Qty
	from	to	Part #	Part #	Part #	
9/16"	7/16"	25/32"	10006	20006	30006	10
	1/2"	29/32"	10008	20008	30008	10
	9/16"	1-1/16"	10010	20010	30010	10
	11/16"	1-1/4"	10012	20012	30012	10
	13/16"	1-1/2"	10016	20016	30016	10
	13/16"	1-3/4"	10020	20020	30020	10
	1-1/16"	2"	10024	20024	30024	10
	1-5/16"	2-1/4"	10028	20028	30028	10
	1-9/16"	2-1/2"	10032	20032	30032	10
	1-13/16"	2-3/4"	10036	20036	30036	10
	2-1/16"	3"	10040	20040	30040	10
	2-5/16"	3-1/4"	10044	20044	30044	10
	2-9/16"	3-1/2"	10048	20048	30048	10
	2-13/16"	3-3/4"	10052	20052	30052	10
	3-1/16"	4"	10056	20056	30056	10
	3-5/16"	4-1/4"	10060	20060	30060	10



style 300



### Marine Grade Worm Gear Clamps

**Size**

- Screw design: 5/16" slotted hex head

**Features**

- Three-piece construction
- Suggested installation torque 30-42 in. lbs.; maximum recommended torque 60 in. lbs.
- All clamps sold 10 per box
- Torque ratings correspond to the torque rating of the screw of the clamp and are not an indication of the working pressure of any hose assembly installed with this clamp

**Material**

- 316 stainless steel marine grade: band, screw, housing

**Approval**

- Clamp meets SAEJ1508 which supercedes Mil Spec WW-C-440B



Band Width	Hose O.D.		316 Stainless Steel
	from	to	Part #
1/2"	3/8"	7/8"	MGC6
	7/16"	1"	MGC8
	9/16"	1-1/16"	MGC10
	9/16"	1-5/16"	MGC12
	11/16"	1-1/2"	MGC16
	3/4"	1-3/4"	MGC20
	1-1/16"	2"	MGC24
	1-5/16"	2-1/4"	MGC28
	1-9/16"	2-1/2"	MGC32
	1-13/16"	2-3/4"	MGC36
	2-11/16"	3"	MGC40
	2-5/16"	3-1/4"	MGC44
	2-9/16"	3-1/2"	MGC48
	2-13/16"	3-3/4"	MGC52
	3-1/16"	4"	MGC56
	2-1/2"	4-1/2"	MGC64
	3-1/16"	5"	MGC72
	3-1/2"	5-1/2"	MGC80
	4-3/32"	6"	MGC88
	4-1/2"	6-1/2"	MGC96
5"	7"	MGC104	



## Aero-Seal® Liner Worm Gear Clamps

**Size**

- Screw design: 5/16" hex slotted hex head

**Features**

- The integral extension of the band as a liner (no rivets or welds) protects soft surface hose (silicone and others) from damage caused by extrusion or shearing through the band slots
- All clamps sold 10 per box

**Materials**

- Band, saddle, housing: stainless steel Style DL
- Screw: plated carbon steel Style DLS
- Screw: 410 stainless steel



style DLS

Band Width	Hose O.D.		Style DL Part #	Pkg Qty	Style DLS Part #	Pkg Qty
	from	to				
1/2"	7/16"	25/32"	DL9206	10	DLS9406	10
	1/2"	29/32"	DL9208	10	DLS9408	10
	9/16"	1-1/16"	DL9210	10	DLS9410	10
	11/16"	1-1/4"	DL9212	10	DLS9412	10
	13/16"	1-1/2"	DL9216	10	DLS9416	10
	13/16"	1-3/4"	DL9220	10	DLS9420	10
	1-1/16"	2"	DL9224	10	DLS9424	10
	1-5/16"	2-1/4"	DL9228	10	DLS9428	10
	1-9/16"	2-1/2"	DL9232	10	DLS9432	10
	1-13/16"	2-3/4"	DL9236	10	DLS9436	10
	2-1/16"	3"	DL9240	10	DLS9440	10
	2-5/16"	3-1/4"	DL9244	10	DLS9444	10
	2-9/16"	3-1/2"	DL9248	10	DLS9448	10

## WaveSeal Clamps

**Application**

- Provides optimal retention in applications involving thermal cycling and / or high vibration

**Size**

- 5/16" head screw

**Features**

- Produces a sealing O-ring effect that prevents leakage
- Suggested installation torque 50-70 in. lbs.
- All clamps sold 10 per box
- Torque ratings correspond to the torque rating of the screw of the clamp and are not an indication of the working pressure of any hose assembly installed with this clamp

**Materials**

- Band: 300 stainless steel
- Liner and housing: 300 stainless steel
- Screw: 410 stainless steel



Band Width	Hose O.D.		Part #	Pkg Qty
	from	to		
9/16"	1-3/32"	1-5/16"	WSS16	10
	1-1/8"	1-1/2"	WSS19	10
	1-1/8"	1-9/16"	WSS20	10
	1-7/16"	1-11/16"	WSS22	10
	1-1/2"	1-13/16"	WSS24	10
	1-3/4"	2-1/16"	WSS28	10
	1-15/16"	2-5/16"	WSS32	10
	2"	2-7/16"	WSS34	10
	2-1/8"	2-9/16"	WSS36	10
	2-5/16"	2-13/16"	WSS40	10
	2-1/2"	3-1/16"	WSS44	10
	2-11/16"	3-5/16"	WSS48	10
	2-7/8"	3-9/16"	WSS52	10
	3-1/16"	3-13/16"	WSS56	10
	3-1/4"	4-1/16"	WSS60	10
	3-7/16"	4-5/16"	WSS64	10
	3-3/4"	4-13/16"	WSS72	10
	4-3/16"	5-5/16"	WSS80	10
	4-1/2"	5-13/16"	WSS88	10



## Constant Torque Worm Gear Clamps

### Feature

- A patented Belleville spring mechanism permits the clamp to automatically increase or decrease its own diameter due to changes in operational or environmental temperatures

### Materials

- 3/8" hex, carbon steel screw
- 5/8" wide 300 stainless steel band

Band Width	Hose O.D.		Part #
	from	to	
5/8"	1"	1-3/4"	CT175L
	1-1/4"	2-1/8"	CT200L
	1-3/4"	2-5/8"	CT250L
	2-1/4"	3-1/8"	CT300L
	2-3/4"	3-5/8"	CT350L
	3-1/4"	4-1/8"	CT400L
	3-3/4"	4-5/8"	CT450L
	4-1/4"	5-1/8"	CT500L
	4-3/4"	5-5/8"	CT550L
	5-1/4"	6-1/8"	CT600L
	5-3/4"	6-5/8"	CT650L
	6-1/4"	7-1/8"	CT700L
	6-3/4"	7-5/8"	CT750L
	7-1/4"	8-1/8"	CT800L
	7-3/4"	8-5/8"	CT850L
	8-1/4"	9-1/8"	CT900L
8-3/4"	9-5/8"	CT950L	



## HTM Hi Torque Worm Gear Clamps

### Features

- Withstands more than three times the SAE torque requirements for worm-driven clamps
- Eight screw threads are engaged in the band simultaneously for incredible torquing drive (over 90 in. lbs.), sealing pressure and vibration resistance
- Slotted hex head screw design
- Torque ratings correspond to the torque rating of the screw of the clamp and are not an indication of the working pressure of any hose assembly installed with this clamp 

### Materials

- Band and housing: 300-series half hard stainless<sup>1</sup>
- Screw: 410 stainless steel screw

Band Width	Hose O.D.		Stainless Steel Part #
	from	to	
5/8"	1-1/4"	2-1/8"	HTM200
	1-1/4"	2-5/8"	HP2 <sup>1</sup>
	1-3/4"	2-5/8"	HTM250
	2-1/8"	4-1/8"	HP3 <sup>1</sup>
	2-1/4"	3-1/8"	HTM300
	2-3/4"	3-5/8"	HTM350
	3-1/2"	4-1/8"	HTM400
	3-3/4"	4-5/8"	HTM450
	4"	6-1/8"	HP4 <sup>1</sup>
	4-1/4"	5-1/8"	HTM500
	4-3/4"	5-5/8"	HTM550
	5-1/4"	6-1/8"	HTM600
	5-3/4"	6-5/8"	HTM650
	6-1/8"	9-1/8"	HP5 <sup>1</sup>
	6-1/4"	7-1/8"	HTM700
	6-3/4"	7-5/8"	HTM750
	7-1/4"	8-1/8"	HTM800
	7-3/4"	8-5/8"	HTM850
	8-1/4"	9-1/8"	HTM900



style HTM



style HP

<sup>1</sup> Extended hose O.D. range

## Assorted Clamps

### Features

- Resealable bag of 10 pieces
- Contains:
  - 2 - Micro-Gear® Size 4
  - 1 - Hy-Gear® Size 6
  - 3 - Hy-Gear Size 12
  - 3 - Hy-Gear Size 20
  - 1 - Hy-Gear Size 36



### Approval

- Uniform Plumber Code (UPC), certified (1/2" Hy-Gear clamps)

Hose O.D.		Stainless Steel Part #
from	to	
1/4"	2-3/4"	MGC-10PC

## Dixon® Worm Gear Clamp Racks

### Size

- Rack with clamps contains (9) clamp sizes with diameter ranges from 7/32" - 2-3/4"

### Features

- Sign identifies each clamp size and diameter range
- CRWC, Clamps included are:
  - 30 of part# MH4
  - 30 of part# MH6
  - 20 of part# HS10
  - 20 of part# HS12
  - 20 of part# HS20
  - 20 of part# HS24
  - 20 of part# HS28
  - 20 of part# HS32
  - 20 of part# HS36

### Material

- Top load metal rack made of nickel plated steel rods with enameled steel sign



CRWC



CR

Description	Part #
with 200 clamps	CRWC
without clamps	CR

## 19-Piece Assortment Pack

### Application

- Applications include plumbing, industrial, marine, hardware, automotive, and household use

### Features

- Reusable plastic case for easy identification and organization
- Contains:
 

5/16" band includes: <ul style="list-style-type: none"> <li>6 pcs of 5/16"-5/8" O.D.</li> <li>4 pcs of 5/16"-7/8" O.D.</li> <li>2 pcs of 7/16"-1" O.D.</li> </ul>	1/2" band includes: <ul style="list-style-type: none"> <li>2 pcs of 1/2"-1-1/6" O.D.,</li> <li>2 pcs of 1/2"-1-1/4" O.D.,</li> <li>1 pc of 3/4"-1-1/34" O.D.,</li> <li>1 pc of 1-1/4"-2-1/4" O.D.,</li> <li>1 pc 3/4"- 2-3/4" O.D.</li> </ul>
---	---



HCVP-19

### Specifications

- SAE Sizes 4, 6, 8, 10, 12, 20, 28, 36
- Corrosion-resistant with all 300-series stainless steel construction

Description	Part #
19-piece assortment clamp pack	HCVP-19

## Quick-Release Worm Gear Clamps

### Size

- Screw design: 5/16" slotted hex head

### Features

- Suggested installation torque 25-35 in. lbs., maximum recommended torque 50 in. lbs.
- Parts showing package quantities are sold in package quantities only
- Torque ratings correspond to the torque rating of the screw of the clamp and are not an indication of the working pressure of any hose assembly installed with this clamp



### Materials

- Band and housing: 201-series stainless
- Style LS Screw: plated hardened carbon steel
- Style LSS Screw: SAE 410-series stainless



style LS



style LSS

Band Width	Hose O.D.		Style LS Part #	Pkg Qty	Style LSS Part #	Pkg Qty
	from	to				
1/2"	1-1/2"	3-1/2"	LS48	10	LSS48	10
	1"	4"	LS56	10	---	---
	2"	5"	LS72	10	LSS72	10
	2"	6"	LS88	10	LSS88	10
	3-1/2"	6-1/2"	LS96	---	---	---
	2-7/8"	7"	LS104	10	LSS104	10
	1-3/4"	8-1/2"	LS128	---	LSS128	---
	2"	10"	LS152	---	---	---
	2"	12-1/4"	LS188	---	LSS188	---
	10-3/16"	14"	---	---	LSS216	---
	1-3/4"	16"	---	---	LSS248	---
	1-7/8"	20"	---	---	LSS312	---

## Worm Gear Make-A-Clamp Kits

### Application

- A maintenance clamp system in a box; by simply cutting off a piece of banding from a continuous roll, you can make any size stainless steel worm-driven clamp from 2" diameter and up, perfect applications requiring for varying sized large clamps

### Sizes

- Band width: 1/2"
- Band thickness: .023"
- Screw design: 5/16" slotted hex head

### Feature

- Reusable

### Materials

- Band and housing material: 300 stainless
- Screw material: 410 stainless

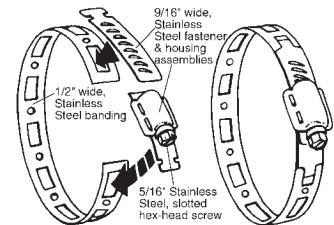

Contents	Stainless Steel Part #
mini kit: 8-1/2' band, 3 adjustable fasteners, 1 band splice	4000
kit with 100' band, 25 adjustable fasteners, 10 band splices	4001
kit with 50' band, 10 adjustable fasteners, 5 band splices	4002
box with 10 adjustable fasteners: priced per box	4004
box with 100' band, 10 band splices	4005
box with 50' band, 5 band splices	4006
6" demonstrator kit with clamps	4007
box with 10 band splices: priced per box	4008

## T-Bolt Clamps

### Style TBC

**Size**

- 3/4" wide, .025" thick,

**Features**

- Can be applied with a standard 7/16" socket wrench
- Not for use with pneumatic tools 

**Materials**

- 300-series stainless steel band
- Alloy steel bolt, torque rating: 70 in. lbs.

### Style STBC

**Size**

- 3/4" wide, .025" thick,

**Features**

- Can be applied with a standard 7/16" socket wrench
- Not for use with pneumatic tools 

**Materials**

- 300-series stainless steel band
- 300-series stainless steel bolt, torque rating: 50 in/lbs



style TBC



style STBC

Hose O.D.		Style TBC Part #	Hose O.D.		Style STBC Part #	Optional Qty
from	to		from	to		
1.25"	1.406"	TBC131	1.25"	1.4063"	STBC131	25
1.34"	1.56"	TBC150	1.31"	1.56"	STBC150	25
1.56"	1.81"	TBC175	1.44"	1.69"	STBC163	25
1.69"	1.94"	TBC188	1.56"	1.81"	STBC175	25
1.81"	2.06"	TBC200	1.69"	1.94"	STBC188	25
2.06"	2.31"	TBC225	1.81"	2.06"	STBC200	25
2.19"	2.5"	TBC238	1.93"	2.18"	STBC212	25
2.31"	2.62"	TBC250	2.06"	2.31"	STBC225	25
2.31"	2.62"	TBC256	2.19"	2.5"	STBC238	25
2.37"	2.68"	TBC263	2.31"	2.62"	STBC250	25
2.50"	2.81"	TBC275	2.31"	2.62"	STBC256	25
2.63"	2.94"	TBC288	2.37"	2.68"	STBC263	25
2.75"	3.06"	TBC300	2.50"	2.81"	STBC275	25
2.88"	3.19"	TBC312	2.63"	2.94"	STBC288	25
3.00"	3.31"	TBC325	2.75"	3.06"	STBC300	25
3.25"	3.56"	TBC350	2.88"	3.19"	STBC312	25
3.50"	3.81"	TBC375	3.00"	3.31"	STBC325	25
3.56"	3.87"	TBC382	3.25"	3.56"	STBC350	25
3.75"	4.06"	TBC400	3.38"	3.69"	STBC362	25
4.00"	4.30"	TBC425	3.50"	3.81"	STBC375	25
4.25"	4.56"	TBC450	3.56"	3.87"	STBC382	25
4.50"	4.81"	TBC475	3.75"	4.06"	STBC400	25
4.75"	5.06"	TBC500	4.00"	4.30"	STBC425	25
5.00"	5.31"	TBC525	4.25"	4.56"	STBC450	25
5.25"	5.56"	TBC550	4.50"	4.81"	STBC475	25
5.50"	5.81"	TBC575	4.75"	5.06"	STBC500	25
5.75"	6.06"	TBC600	5.00"	5.31"	STBC525	25
6.00"	6.31"	TBC625	5.25"	5.56"	STBC550	25
6.25"	6.56"	TBC650	5.50"	5.81"	STBC575	25
6.50"	6.81"	TBC675	5.75"	6.06"	STBC600	25
6.75"	7.06"	TBC700	6.00"	6.31"	STBC625	25
7.25"	7.56"	TBC750	6.25"	6.56"	STBC650	25
			6.50"	6.81"	STBC675	25
			6.75"	7.06"	STBC700	25
			7.00"	7.31"	STBC725	25
			7.25"	7.56"	STBC750	25
			7.75"	8.06"	STBC800	25
			8.00"	8.31"	STBC825	25
			8.25"	8.56"	STBC850	25
			8.63"	8.94"	STBC888	25
			8.75"	9.06"	STBC900	25
			9.25"	9.56"	STBC950	25
			9.75"	10.06"	STBC1000	10
			10.63"	10.94"	STBC1088	10
			11.75"	12.06"	STBC1200	10
			12.63"	12.94"	STBC1288	10

## Heavy Duty T-Bolt Clamps

**Size**

- 7/8" wide, .040" thick

**Features**

- Can be applied with a standard 1/2" socket wrench
- Not for use with pneumatic tools



**Materials**

- 300-series stainless steel band
- Style HTBC carbon steel bolt, torque rating: 150 in/lbs
- Style HSTBC 300-series stainless steel bolt, torque rating: 150 in. lbs.



style HTBC



style HSTBC

Hose O.D.		Style HTBC Part #	Style HSTBC Part #
from	to		
2.125"	2.4375"	HTBC238	HSTBC238
2.250"	2.5625"	HTBC250	HSTBC250
2.750"	3.0625"	HTBC300	HSTBC300
3.250"	3.5625"	HTBC350	HSTBC350
3.750"	4.0625"	HTBC400	HSTBC400
4.250"	4.5625"	HTBC450	HSTBC450
4.750"	5.0625"	HTBC500	HSTBC500
5.250"	5.5625"	HTBC550	HSTBC550
5.750"	6.0625"	HTBC600	HSTBC600
6.250"	6.5625"	HTBC650	HSTBC650
6.750"	7.0625"	HTBC700	HSTBC700
7.250"	7.5625"	HTBC750	HSTBC750
7.750"	8.0625"	HTBC800	HSTBC800
8.266"	8.562"	---	HSTBC850
8.646"	8.942"	---	HSTBC888
8.766"	9.062"	---	HSTBC900
9.266"	9.562"	---	HSTBC950
9.766"	10.062"	---	HSTBC1000
10.646"	10.942"	---	HSTBC1088
12.646"	12.942"	---	HSTBC1288



## Long Bolt T-Bolt Clamps

**Size**

- 3/4" wide, .025" thick

**Features**

- Can be applied with a standard 7/16" socket wrench.
- Not for use with pneumatic tools

**Materials**

- 300-series stainless steel band
- 300-series stainless steel bolt, torque rating: 50 in. lbs.



Hose O.D.		300-Series Stainless Steel Part #	Optional Qty
from	to		
2.80"	3.37"	STBC325L	25
3.05"	3.62"	STBC350L	25
3.37"	3.94"	STBC382L	25
3.55"	4.12"	STBC400L	25
3.75"	4.32"	STBC420L <sup>1</sup>	25
3.87"	4.44"	STBC432L	25
4.05"	4.62"	STBC450L	25
4.37"	4.94"	STBC482L	25
4.55"	5.12"	STBC500L	25
4.87"	5.44"	STBC532L	25
5.05"	5.62"	STBC550L	25
5.37"	5.94"	STBC582L	25
5.55"	6.12"	STBC600L <sup>1</sup>	25
5.87"	6.44"	STBC632L	25
6.05"	6.62"	STBC650L	25
6.30"	6.87"	STBC675L	25
6.53"	7.10"	STBC698L	25
6.55"	7.12"	STBC700L <sup>1</sup>	25
6.62"	7.19"	STBC707L	25
8.05"	8.62"	STBC850L	25
8.30"	8.87"	STBC875L	25
8.43"	9.00"	STBC888L	25
8.62"	9.19"	STBC907L	25
10.25"	10.82"	STBC1070L	25
10.43"	11.00"	STBC1088L	25
10.62"	11.19"	STBC1107L <sup>1</sup>	25
10.72"	11.29"	STBC1117L	25
12.20"	12.77"	STBC1265L	25
12.43"	13.00"	STBC1288L	25
12.75"	13.32"	STBC1320L	25
14.20"	14.77"	STBC1465L	25
14.43"	15.00"	STBC1488L	25
14.75"	15.32"	STBC1520L	25
16.20"	16.77"	STBC1665L	25
16.43"	17.00"	STBC1688L	25

<sup>1</sup> Stock quantities only

## Center Punch Band Clamps

### Features

- Install with center punch tools F1, F38, F40, and F100 located on page 473 other manufacturers' punch style tools may also be used
- Sold in package quantities only

### Material

- On stainless clamps, bands are 300-series stainless steel, buckles are 302-series stainless steel

### Pre-formed F-Series

Band Width	Clamp I.D.	Band THK	Stainless Steel Part #	Pkg Qty	Band THK	Galvanized Steel Part #	Pkg Qty
3/8"	13/16"	.020"	FS3	100	.025"	F3	100
	1-3/8"	.020"	FS311	100	.025"	F311	100
5/8"	1"	.022"	FS4	100	.025"	F4	100
	1-1/4"	.022"	FS5	100	.025"	F5	100
	1-1/2"	.022"	FS6	100	.031"	F6	100
	1-3/4"	.022"	FS7	100	.031"	F7	100
	2"	.022"	FS8	100	.031"	F8	100
	2-1/4"	.022"	FS9	100	.031"	F9	100
	2-1/2"	.022"	FS10	50	.031"	F10	50
	2-3/4"	.022"	FS11	50	.031"	F11	50
5/8"	3"	.022"	FS12	50	.031"	F12	50
	3-1/2"	.022"	FS14	50	.031"	F14	50
	4"	.022"	FS16	25	.031"	F16	25
	4-1/2"	.022"	FS18	25	.031"	F18	25
	5"	.022"	FS20	25	.031"	F20	25
	6"	.022"	FS24	25	.031"	F24	25
	7"	.022"	FS28	25	.031"	F28	25
	8"	.022"	FS32	25	.031"	F32	25



J

### Open End FO-Series

Band Width	Clamp I.D.	Band THK	Stainless Steel Part #	Pkg Qty	Band THK	Galvanized Steel Part #	Pkg Qty
3/8"	13/16"	.020"	FOS3	100	.025"	F03	100
	1-3/8"	.020"	FOS311	100	.025"	F0311	100
	2"	.020"	FOS316	100	.025"	F0316	100
	3-1/8"	.020"	FOS325	100	.025"	F0325	100
5/8"	2"	.022"	FOS8	100	.025"	F08	100
	2-1/2"	.022"	FOS10	50	.025"	F010	50
	3"	.022"	FOS12	50	.031"	F012	50
	3-1/2"	.022"	FOS14	50	.031"	F014	50
	4"	.022"	FOS16	50	.031"	F016	50
	4-1/2"	.022"	FOS18	50	.031"	F018	50
	5"	.022"	FOS20	25	.031"	F020	25
	6"	.022"	FOS24	25	.031"	F024	25
	7"	.022"	FOS28	25	.031"	F028	25
	8"	.022"	FOS32	25	.031"	F032	25
5/8"	9"	.022"	---	---	.031"	F036	25
	10"	.022"	---	---	.031"	F040	25
	12"	.022"	---	---	.031"	F048	25
	14"	.022"	---	---	.031"	F056	10



## Universal Pre-formed K-Series

### Features

- Can be center punched or rolled over; install with the center punch or roll over tools located on page 473
- Fast-Lok™ tools: F1, F40, F100, page 473
- Super Strap Tools: 51960 screw action with 51970 adapter page 474
- Bandit®: S100 air tool with S180 Jr. head, C-001 hand tool with J001 Jr. adapter, S350 air tool with S260 Jr. head, T-240 for 3/8" only or T-250 for 3/8" and 5/8", S-38 for 3/8" and 5/8", J-102 Pok-It™ for 3/8" only
- Punch-Lok® tools: P-1000 for 3/8" and 5/8", P-3000 for 3/8" only, P-38 for 3/8" and 5/8"
- Sold in package quantities only

### Materials

- On stainless clamps, bands are 300-series stainless steel, buckles are 302-series stainless steel



Band Width	Clamp I.D.	Band THK	Stainless Steel Part #	Pkg Qty	Band THK	Galvanized Steel Part #	Pkg Qty
3/8"	13/16"	.025"	KS3	100	.025"	K3	100
	1-3/8"	.025"	KS311	100	.025"	K311	100
5/8"	1"	.030"	KS4	100	.031"	K4	100
	1-1/4"	.030"	KS5	100	.031"	K5	100
	1-1/2"	.030"	KS6	100	.031"	K6	100
	1-3/4"	.030"	KS7	100	.031"	K7	100
	2"	.030"	KS8	100	.031"	K8	100
	2-1/4"	.030"	KS9	100	.031"	K9	100
	2-1/2"	.030"	KS10	50	.031"	K10	50
	2-3/4"	.030"	KS11	50	.031"	K11	50
	3"	.030"	KS12	50	.031"	K12	50
	3-1/2"	.030"	KS14	50	.031"	K14	50
	4"	.030"	KS16	25	.031"	K16	25
	4-1/2"	.030"	KS18	25	.031"	K18	25
	5"	.030"	KS20	25	.031"	K20	25
	6"	.030"	KS24	25	.031"	K24	25
	7"	.030"	KS28	25	.031"	K28	25
	8"	.030"	KS32	25	.031"	K32	25

J



## Dixon® Smooth I.D. - Roll Over Type Clamps

### Application

- For use with industrial hose made of stiffer, thinner thermoplastics

### Features

- Provide a uniform, gap-free inside diameter and strong holding power
- Install with roll over type clamp tools and most common band clamp tools such as the 51960 and 51970 band tools on page 474
- Sold in package quantities only

Band Width	Clamp I.D.	Band THK	201 Stainless Steel Part #	Pkg Qty	Galvanized Steel Part #	Pkg Qty
3/8"	13/16"	.025"	JS201	100	JS301	100
	1"	.025"	JS243	100	JS343	100
	1-3/8"	.025"	JS202	100	JS302	100
	2"	.025"	JS245	100	---	---
1/2"	1"	.030"	JS203	100	JS303	100
	1-1/4"	.030"	JS204	100	JS304	100
	2-3/4"	.030"	JS230	100	JS330 <sup>1</sup>	100
5/8"	1-1/2"	.030"	JS205	100	JS305	100
	1-3/4"	.030"	JS206	100	JS306	100
	2"	.030"	JS207	100	JS307	100
	2-1/4"	.030"	JS208	100	JS308	100
	2-1/2"	.030"	JS209	100	JS309	100
3/4"	2-3/4"	.030"	JS210	50	---	---
	3"	.030"	JS211	50	JS311	50
	3-1/2"	.030"	JS212	50	JS312	50
	4"	.030"	JS213	25	JS313	25
	4-1/2"	.030"	JS214	25	JS314	25
	5"	.030"	JS215	25	JS315	25
	6"	.030"	JS216	25	---	---
	7"	.030"	JS218	25	---	---

<sup>1</sup> Stock quantities only



## Dixon Smooth I.D. Center Punch Clamps

### Application

- For use in applications where conditions are highly corrosive

### Features

- Double wrapped and locked with the conical punch of the F100 tool page 473
- Unique dimple design offers excellent sealing strength while maintaining radial compression
- Heavy buckle provides optimal holding power
- Ideal for thin wall hose
- Low profile
- Sold in package quantities only

Band Width	Clamp I.D.	Band THK	201 Stainless Steel Part #	Pkg Qty
5/8"	1"	.025"	HBC4S	100
	1-1/4"	.025"	HBC5S	100
	1-1/2"	.025"	HBC6S	100
	1-3/4"	.025"	HBC7S	100
	2"	.025"	HBC8S	100
	2-1/4"	.025"	HBC9S	100
	2-1/2"	.025"	HBC10S	50
	2-3/4"	.025"	HBC11S	50
	3"	.025"	HBC12S	50
	3-1/2"	.025"	HBC14S	50
	4"	.025"	HBC16S	25
	4-1/2"	.025"	HBC18S	25
	5"	.025"	HBC20S	25
	6"	.025"	HBC24S	25
	7"	.025"	HBC28S	25
8"	.025"	HBC32S	25	



### Band & Buckles System



**Features**

- Install with C2 or 51960 band clamp tools
- Sold in box quantities only

Band Width	201 Stainless Steel Part #	Pkg Qty	Galvanized Steel Part #	Pkg Qty
3/8"	CS375	100	CG375	100
1/2"	CS500	100	CG500	100
5/8"	CS625	100	CG625	100
3/4"	CS750	100	CG750	50

### Strapping

**Feature**

- Install with C2 or 51960 band clamp tools



Band Width	Band Thickness	Length	201 Stainless Steel Part #	Galvanized Steel Part #
3/8"	.025"	100'	SS375	SG375
1/2"	.031"	100'	SS500	SG500
5/8"	.031"	100'	SS625	SG625
3/4"	.031"	100'	SS750	SG750

### Set Screw Buckles

**Application**

- Used in applications when a temporary clamp is desired or space limitations do not allow for tool roll-over



**Features**

- Set screw locks band after tensioning
- Sold in box quantities only

Band Width	201 Stainless Steel Part #	Pkg Qty
1/2"	SSB500	25
3/4"	SSB750 <sup>1</sup>	25

<sup>1</sup> 3/4" buckle may be used with 5/8" band

### Stainless Steel Banding with Tote

**Features**

- Resistant to moisture
- Built-in handle
- Full view of available band
- Easy to dispense and recoil



Band Width	Band Thickness	Length	Package Description	201 Stainless Steel Part #
1/2"	.030"	100'	plastic blue tote	ST204B
5/8"	.030"	100'	plastic green tote	ST205G
3/4"	.030"	100'	plastic red tote	ST206R

## Band Clamp Hand Tools

### Locking Hand Tool

**Applications**

- For application of punch type 3/8" and 5/8" band clamps
- For use with F-series only

Part #
F38



### Intermediate Hand Tool

**Application**

- For application of 3/8" and 5/8" band clamps

Part #
F40



### Hand Tool for 5/8" Clamps

**Application**

- For application of 5/8" band clamps

**Feature**

- Imported

Part #
F1



### Hand Tool for 3/8" & 5/8" Clamps

**Application**

- For application of 3/8" and 5/8" band clamps

**Feature**

- Made in the USA

Part #
F100



### Adapter for F100 Tool

**Application**

- 3/8" clamp adapter for F100 tool only

Part #
F229

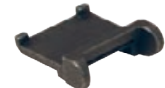

## Flexible Hose Clamp Driver

**Application**

- Flexible shaft and no-slip grip provide 90° access and work best in hard-to-reach places such as compact car and boat engines, as well as plumbing repair applications

**Features**

- Socket fits mini and standard hose clamp screw heads
- Flip the socket for the desired size of 1/4" or 5/16"

Socket Size	Part #
1/4" or 5/16"	FHCD



### Band Clamp Punching Mallet



Part #

F225

### Clamp Cutter



Part #

F550

### Band & Buckle Clamping Tools



Description

Clamping tool for band and buckles

Part #

51960

J



#### Application

- For 51960 tool above

Description

adapter for 51960 tool to install preformed clamps

Part #

51970

### Hose Clamp Safety Caps

#### Application

- Push onto the end of a hose clamp

#### Features

- Protects installers from cuts and scrapes
- Protects surrounding materials from abrasion and sharp edges
- Provides a clean, professional, and finished look for any application
- Installs quickly and easily



Width

1/2"

9/16"

Part #

SCAP12-25

SCAP12-100

SCAP916-25

SCAP916-100

## Pinch-On Clamps

### Single Ear

**Sizes**

- Band width: .275"
- Band thickness: .030"

**Feature**

- Sold in package quantities only

Nominal Size	Range		Zinc Plated Steel Part #	304 Stainless Steel Part #	Pkg Qty
	closed	open			
3/8"	.350"	.413"	105	105R	100
7/16"	.382"	.445"	113	113R	100
15/32"	.409"	.484"	123	123R	100
1/2"	.449"	.524"	133	133R	100
35/64"	.469"	.551"	140	140R	100
9/16"	.496"	.571"	145	145R	100
5/8"	.543"	.618"	157	157R	100
11/16"	.595"	.669"	170	170R	100
23/32"	.618"	.728"	185	185R	100
3/4"	.669"	.780"	198	198R	100
13/16"	.717"	.827"	210	210R	100
7/8"	.780"	.890"	226	226R	100
15/16"	.839"	.949"	241	241R	100
1"	.898"	1.008"	256	256R	100
1-1/16"	.945"	1.067"	271	271R	100
1-1/8"	1.004"	1.126"	286	286R	100
1-3/16"	1.063"	1.185"	301	301R	100
1-5/16"	1.181"	1.303"	331	331R	100
1-3/8"	1.240"	1.362"	346	346R	100
1-15/32"	1.358"	1.480"	376	376R	100
1-9/16"	1.437"	1.559"	396	396R	100
1-5/8"	1.492"	1.614"	410	410R	100
1-11/16"	1.551"	1.673"	425	425R	100
1-23/32"	1.610"	1.732"	440	440R	100
1-3/4"	1.669"	1.791"	455	455R	100
1-13/16"	1.728"	1.850"	470	470R	100
1-7/8"	1.787"	1.909"	485	485R	100
1-15/16"	1.847"	1.969"	500	500R	100
2"	1.906"	2.028"	515	515R	100



J

**Double Ear****Features**

- When ordering double ear clamps, select nominal clamp size nearest to, but always larger than, the O.D. of material to be clamped after insert has been fitted
- Sold in package quantities only

Nominal Size	Range		Band Width	Zinc Plated Steel Part #	304 Stainless Steel Part #	Pkg Qty
	closed	open				
3/16"	.134"	.197"	.197"	0305	0305R	100
1/4"	.197"	.276"	.236"	0507	0507R	100
5/16"	.276"	.354"	.275"	0709	0709R	100
3/8"	.319"	.433"	.275"	0811	0811R	100
1/2"	.425"	.512"	.275"	1113	1113R	100
9/16"	.492"	.591"	.295"	1315	1315R	100
19/32"	.551"	.669"	.315"	1517	1517R	100
5/8"	.591"	.709"	.315"	1518	1518R	100
3/4"	.638"	.787"	.335"	1720	1720R	100
13/16"	.709"	.866"	.354"	1922	1922R	100
7/8"	.748"	.906"	.354"	2023	2023R	100
15/16"	.827"	.984"	.394"	2225	2225R	100
1"	.886"	1.063"	.394"	2327	2327R	100
1-1/8"	1.035"	1.221"	.394"	2731	2731R	100
1-7/16"	1.260"	1.457"	.394"	3437	3437R	100
1-1/2"	1.378"	1.575"	.394"	3740	3740R	100



## Pinch-On Stepless® Ear Clamps

### Features

- Once installed and clamped, tampering is easily visible
- Clamps are not reusable; they should not be pried open, doing so renders the clamp nonfunctional
- Ensured clamping seal
- For low durometer or thin-walled hose/tubing
- For silicon, vinyl, polyurethane, or other high-tech materials
- Smooth inner band prevents damage to the hose while the tongue-in-groove design provides a 360° seal
- No steps or gaps inside the clamp
- Install clamps using 1098 or 1099 clamp tools below
- Clamps hold against pressure, vibration, and material shrinkage due to temperature changes or aging
- Built-in spring action permits the clamp to breathe without loosening
- When ordering, select the nominal size nearest to, but always larger than, the outside diameter of the material to be clamped, the outside diameter should be determined with connection fully assembled
- Sold in package quantities only



Nominal Size	Range (inches)		304 Stainless Steel Part #	Pkg Qty
	closed	open		
9/32"	.228"	.275"	0983	100
3/8"	.307"	.374"	0986	100
7/16"	.378"	.445"	0989	100
1/2"	.425"	.524"	0993	100
35/64"	.453"	.551"	0997	100
9/16"	.472"	.571"	0999	100
5/8"	.520"	.618"	1005	100
11/16"	.571"	.669"	1009	100
3/4"	.654"	.779"	1021	100
13/16"	.701"	.827"	1029	100

### Clamp Service Kit

#### Includes

- 15 of part #0709
- 15 of part #0811
- 15 of part #1113
- 15 of part #1315
- 15 of part #1518
- 12 of part #1720
- 12 of part #2023
- 12 of part #2225
- 12 of part #2327
- 1 pair of standard jaw pincers, part # 1098



#### Part #

SK1098

### Standard Jaw Clamp Tool



#### Part #

1098

### Side Jaw Clamp Tool



#### Part #

1099

## Double Bolt Clamps

### Features

- Inner surface has dual gripping ridges
- Bolt lugs are reinforced to prevent bending out of alignment
- Torque values for clamps are based on dry bolts
- The use of lubricant on bolts will adversely effect clamp performance
- Measure hose O.D. accurately before ordering clamps
- Consult Dixon® when using double bolt clamps on helical wire hose



Hose O.D.		Plated Iron Part #	Torque in ft. lbs.	Optional Qty
from	to			
1-8/64"	1-12/64"	J48	15	100
1-12/64"	1-24/64"	J49	21	50
1-28/64"	1-34/64"	JX49	21	25
1-40/64"	1-52/64"	DL14	40	25
1-48/64"	2-3/64"	DL20	27	25
2-7/64"	2-19/64"	DL24 <sup>1</sup>	27	25
2-20/64"	2-40/64"	DL32 <sup>1</sup>	40	25
2-32/64"	2-48/64"	DL275	40	25
2-48/64"	3-4/64"	DL306	60	20
3-4/64"	3-24/64"	DL328	60	20
3-16/64"	3-32/64"	DL350	60	20



<sup>1</sup> Investment cast carbon steel

## Double Bolt Clamps with Saddles

Hose O.D.		Plated Iron Part #	Torque in ft. lbs.	Optional Qty
from	to			
3-32/64"	3-52/64"	400	40	25
3-50/64"	4-4/64"	431	40	20
4-2/64"	4-18/64"	463	40	20
4-16/64"	4-60/64"	525	60	10
4-32/64"	5-16/64"	550	60	10
5-8/64"	5-44/64"	600	60	10
5-44/64"	5-60/64"	639	60	10
5-60/64"	6-32/64"	675	60	10
6-32/64"	7-36/64"	769	60	10
7-44/64"	8-12/64"	818	125	5
8-16/64"	8-56/64"	875	125	5
8-60/64"	9-56/64"	988	125	5
9-60/64"	11-24/64"	1125	125	5
11-12/64"	13"	1275	125	3
12-12/64"	14"	1360	200	2
13-12/64"	15"	1450	200	2
15-4/64"	17-32/64"	1700	260	2



## Single Bolt Clamps

**Features**

- Measure hose O.D. accurately before ordering clamps
- Torque values for clamps are based on dry bolts
- The use of lubricant on bolts will adversely effect clamp performance



Hose O.D.		Plated Iron Part #	Torque in ft. lbs.
from	to		
5/64"	1"	2	6
62/64"	1-8/64"	3	6
1-4/64"	1-12/64"	4	6
1-10/64"	1-16/64"	5	6
1-16/64"	1-24/64"	6	6
1-22/64"	1-28/64"	7	6
1-28/64"	1-36/64"	8	6
1-42/64"	1-48/64"	10	6
1-48/64"	1-56/64"	11	6
1-56/64"	2-2/64"	12	6
2"	2-8/64"	13	12
2-8/64"	2-18/64"	14	12
2-16/64"	2-26/64"	15	12
2-24/64"	2-32/64"	16	12
2-32/64"	2-40/64"	17	12
2-40/64"	2-56/64"	18	12
2-56/64"	3-4/64"	19	12
3-4/64"	3-16/64"	20	12
3-16/64"	3-28/64"	21	12
3-28/64"	3-40/64"	22	21
3-40/64"	3-52/64"	23	21
3-52/64"	4-8/64"	24	21
4-8/64"	4-20/64"	25	21
4-16/64"	4-32/64"	26	21
4-28/64"	4-40/64"	27	21
4-40/64"	4-56/64"	X27	21
4-56/64"	5-16/64"	28	21

NOTE: Single bolt clamps will become obsolete as inventory is depleted.





## Spiral Clamps

### Application

- For use on convoluted cover hose



### Features

- More than one clamp may be needed per size; contact the hose manufacturer for more information
- Due to fluctuations in the O.D. of hose each individual installation should be checked
- To determine which style clamp is needed for your hose look at the end of the hose; if the helix spirals in a clockwise direction away from you (along the hose), a clockwise clamp is needed. If the helix spirals in a counterclockwise direction away from you, a counterclockwise clamp is needed. Examples include, but are not limited to: Kuriyama convoluted hose uses counter clockwise clamps; Pacific Echo and Kana Flex use clockwise clamps; Goodyear uses both counter clockwise and clockwise.

### Clockwise

Size	Hose O.D.		Plated Steel, Right Hand Part #
	from	to	
1-1/2"	1-34/64"	1-52/64"	SC150
2"	2-18/64"	2-32/64"	SC200
2-1/2"	2-46/64"	3-8/64"	SC250
3"	3"	3-32/64"	SC300
4"	4"	4-32/64"	SC400
5"	5-6/64"	5-32/64"	SC500
6"	6-16/64"	7"	SC600
8"	8-32/64"	9-16/64"	SC800
10"	10-40/64"	11-16/64"	SC1000
12"	11-52/64"	12-61/64"	SC1200



J

### Counter Clockwise

Size	Hose O.D.		Plated Steel, Left Hand Part #
	from	to	
1-1/2"	1-34/64"	1-52/64"	SCCW150
2"	2-18/64"	2-32/64"	SCCW200
2-1/2"	2-46/64"	3-8/64"	SCCW250
3"	3"	3-32/64"	SCCW300
4"	4"	4-32/64"	SCCW400
5"	5-6/64"	5-32/64"	SCCW500
6"	6-16/64"	7"	SCCW600
8"	8-32/64"	9-16/64"	SCCW800
10"	10-40/64"	11-16/64"	SCCW1000
12"	11-52/64"	12-61/64"	SCCW1200



## Quick Disconnects.....481 - 538

H-series.....	481 - 487
H-BOP series.....	488
HS-series.....	489
K-series.....	490 - 491
AG-series.....	492 - 493
V-series.....	494 - 502
TR-series.....	503
HT-series Correct Connect®.....	504 - 508
HTE-series Correct Connect.....	509
HTZ-series Correct Connect.....	510
Flushface adapter.....	510
XK-series.....	511
ST-series.....	512 - 514
PD-series.....	515
VEP-series.....	516 - 518
VEP-BOP series.....	519
W-series.....	520 - 522
WS-series.....	523 - 525
WS-BOP series.....	526
T-series.....	527 - 528
CVV-series.....	529 - 530
TD-series.....	530
E-series.....	531 - 533
EA-series.....	534
CM-series.....	535 - 538

## Adapters.....539 - 558

Flat Face.....	539 - 540
Unions.....	539
Connectors.....	539
90° elbows.....	539-540
Tees.....	540
Caps.....	540
Plugs.....	540
O-ring Boss®.....	541 - 543
Reducers.....	541
Unions.....	541
Elbows.....	542 - 543
Tees.....	543
Plugs.....	543
37° JIC.....	544 - 550
Flare.....	544
Swivels.....	545
90° flare elbows.....	545 - 546, 549
45° elbows.....	547
Flare unions.....	547
Flare tees.....	547
Caps.....	548

## Adapters (cont.) .....539 - 558

Nuts.....	548 - 549
Plugs.....	548
Sleeves.....	548
Straight weld end metal hose fittings.....	550
45° elbow weld end metal hose fittings.....	550
90° elbow weld end metal hose fittings.....	550
NPTF.....	551 - 555
Pipe nipples.....	551
Hex reducer bushings.....	551
90° elbows.....	551
Swivels.....	552
Swivel nuts.....	552
Hex pipe couplings.....	552
90° elbow swivels.....	553
45° elbows.....	553
Tees.....	554
Hex caps.....	555
Hex plugs.....	555
Metric parallel thread.....	555
BSPP (British Standard Pipe Parallel).....	556
Flareless bite fittings.....	557 - 559

## Valves.....560 - 563

Flow control.....	560
Series C check.....	561
High pressure ball.....	561
Needle.....	562 - 563

## Hydraulic Hose Fittings.....564 - 568

Code 61 / 62 flanges.....	564 - 566
4-bolt NPTF ports.....	564
4-bolt SAE ports.....	564
4-bolt flange pipe socket welds.....	565
Split flange kits.....	566
Straight JIC.....	566
90° JIC elbows.....	566
45° JIC elbows.....	566
Suction and return line couplings.....	567
Double bolt clamps.....	567
Stems.....	568
Clamps for 1 or 2 wire.....	568
Inline hydraulic filters.....	568

## Pipe and Tubing Clamps ..... 569 - 570

Standard series.....	569
Twin series.....	569
Heavy duty series.....	570

## H-Series Hydraulic Couplings

### Features

- Poppet style shut-off valves in both coupler and plug
- Interchangeable with Parker-Hannifin 60 series, Hansen HK, Faster HNV and Stucchi IRB/IRBO/IRBX. See hydraulic profile chart on page 485
- Contact Dixon® for pressure ratings and other technical information
- Contact Dixon for additional seal material options

### Specification

- Nitrile seals standard providing temperature range of **-40°F to 250°F (-40°C to 121°C)**

### Approval

- Meets dimensional requirements of ISO7241 Series B

### ISO-B Female Threaded Couplers

Body Size	Threads	Steel Part #	Brass Part #
1/8"	1/8" - 27 NPTF	1HF1	1HF1-B
	7/16" - 20 ORB	1HOF2	---
1/4"	1/4" - 18 NPTF	2HF2	2HF2-B
	1/4" - 19 BSPP	2HBF2	2HBF2-B
	9/16" - 18 ORB	2HOF3	---
3/8"	3/8" - 18 NPTF	3HF3	3HF3-B
	3/8" - 19 BSPP	3HBF3	3HBF3-B
	3/4" - 16 ORB	3HOF4	---
1/2"	1/2" - 14 NPTF	4HF4	4HF4-B
	1/2" - 14 BSPP	4HBF4	4HBF4-B
	7/8" - 14 ORB	4HOF5	---
3/4"	3/4" - 14 NPTF	6HF6	6HF6-B
	3/4" - 14 BSPP	6HBF6	6HBF6-B
	1-1/16" - 12 ORB	6HOF6	---
1"	1" - 11-1/2 NPTF	8HF8	8HF8-B
	1" - 11 BSPP	8HBF8	8HBF8-B
	1-5/16" - 12 ORB	8HOF8	---



steel



brass

**K**

Body Size	Threads	303 Stainless Steel Part #	316 Stainless Steel Part #
1/8"	1/8" - 27 NPTF	1HF1-S	1HF1-SS
1/4"	1/4" - 18 NPTF	2HF2-S	2HF2-SS
	1/4" - 19 BSPP	2HBF2-S	2HBF2-SS
3/8"	3/8" - 18 NPTF	3HF3-S	3HF3-SS
	3/8" - 19 BSPP	3HBF3-S	3HBF3-SS
1/2"	1/2" - 14 NPTF	4HF4-S	4HF4-SS
	1/2" - 14 BSPP	4HBF4-S	4HBF4-SS
3/4"	3/4" - 14 NPTF	6HF6-S	6HF6-SS
	3/4" - 14 BSPP	6HBF6-S	6HBF6-SS
1"	1" - 11-1/2 NPTF	8HF8-S	8HF8-SS
	1" - 11 BSPP	8HBF8-S	8HBF8-SS



303 stainless

## H-Series Hydraulic Couplings

### ISO-B Female Threaded Plugs



steel

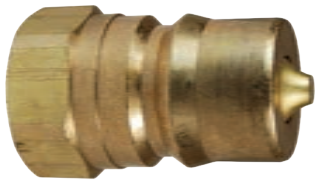

brass



303 stainless

Body Size	Threads	Steel Part #	Brass Part #
1/8"	1/8" - 27 NPTF	H1F1	H1F1-B
	7/16" - 20 ORB	H10F2	---
1/4"	1/4" - 18 NPTF	H2F2	H2F2-B
	1/4" - 19 BSPP	H2BF2	H2BF2-B
	9/16" - 18 ORB	H20F3	---
3/8"	3/8" - 18 NPTF	H3F3	H3F3-B
	3/8" - 19 BSPP	H3BF3	H3BF3-B
	3/4" - 16 ORB	H30F4	---
1/2"	1/2" - 14 NPTF	H4F4	H4F4-B
	1/2" - 14 BSPP	H4BF4	H4BF4-B
	7/8" - 14 ORB	H40F5	---
3/4"	3/4" - 14 NPTF	H6F6	H6F6-B
	3/4" - 14 BSPP	H6BF6	H6BF6-B
	1-1/16" - 12 ORB	H60F6	---
1"	1" - 11-1/2 NPTF	H8F8	H8F8-B
	1" - 11 BSPP	H8BF8	H8BF8-B
	1-5/16" - 12 ORB	H80F8	---

Body Size	Threads	303 Stainless Steel Part #	316 Stainless Steel Part #
1/8"	1/8" - 27 NPTF	H1F1-S	H1F1-SS
1/4"	1/4" - 18 NPTF	H2F2-S	H2F2-SS
	1/4" - 19 BSPP	H2BF2-S	H2BF2-SS
3/8"	3/8" - 18 NPTF	H3F3-S	H3F3-SS
	3/8" - 19 BSPP	H3BF3-S	H3BF3-SS
1/2"	1/2" - 14 NPTF	H4F4-S	H4F4-SS
	1/2" - 14 BSPP	H4BF4-S	H4BF4-SS
3/4"	3/4" - 14 NPTF	H6F6-S	H6F6-SS
	3/4" - 14 BSPP	H6BF6-S	H6BF6-SS
1"	1" - 11-1/2 NPTF	H8F8-S	H8F8-SS
	1" - 11 BSPP	H8BF8-S	H8BF8-SS

### ISO-B Male Threaded Plugs



Body Size	Threads	Steel Part #
1/4"	1/4" - 18 NPTF	H2M2
1/4"	3/8" - 18 NPTF	H2M3

Body Size	Threads	303 Stainless Steel Part #
1/2"	3/4" - 14 NPTF	H4M6-S

## H-Series Hydraulic Couplings

### ISO-B High Volume Female Threaded Couplers

Body Size	Threads	Steel Part #	Brass Part #	303 Stainless Steel Part #	316 Stainless Steel Part #
1-1/4"	1-1/4" - 11-1/2 NPTF	10HF10	10HF10-B	10HF10-S	10HF10-SS
	1-1/4" - 11 BSPP	10HBF10	---	---	10HBF10-SS
1-1/2"	1-1/4" - 11-1/2 NPTF	12HF10	12HF10-B	12HF10-S	---
	1-5/8" - 12 ORB	12HOF10	---	---	---
	1-1/2" - 11-1/2 NPTF	12HF12	12HF12-B	12HF12-S	12HF12-SS
2-1/2"	1-1/2" - 11 BSPP	12HBF12	12HBF12-B	12HBF12-S	12HBF12-SS
	1-7/8" - 12 ORB	12HOF12	---	---	---
	2" - 11-1/2 NPTF	20HF16	20HF16-B	---	---
2-1/2"	2-1/2" - 8 NPTF	20HF20	---	---	---
	3" - 8 NPTF	20HF24	---	---	---



steel



brass



316 stainless

### ISO-B High Volume Female Threaded Plugs

Body Size	Threads	Steel Part #	Brass Part #	303 Stainless Steel Part #	316 Stainless Steel Part #
1-1/4"	1-1/4" - 11-1/2 NPTF	H10F10	H10F10-B	H10F10-S	H10F10-SS
	1-1/4" - 11 BSPP	H10BF10	---	---	H10BF10-SS
1-1/2"	1-1/4" - 11-1/2 NPTF	H12F10	H12F10-B	H12F10-S	---
	1-5/8" - 12 ORB	H12OF10	---	---	---
	1-1/2" - 11-1/2 NPTF	H12F12	H12F12-B	H12F12-S	H12F12-SS
2-1/2"	1-1/2" - 11 BSPP	H12BF12	H12BF12-B	H12BF12-S	H12BF12-SS
	1-7/8" - 12 ORB	H12OF12	---	---	---
	2" - 11-1/2 NPTF	H20F16	H20F16-B	---	---
2-1/2"	2-1/2" - 8 NPTF	H20F20	---	---	---
	3" - 8 NPTF	H20F24	---	---	---



steel



brass



303 stainless



**H-Series Hydraulic Couplings**



**ISO-B Steel Mill 'Slide Gate' Female Threaded Couplers**

Body Size	Female Threads	Steel Part #
1/2"	1/2" - 14 NPTF	4HF4-HV



**ISO-B Steel Mill 'Slide Gate' Female Threaded Plugs**

Body Size	Female Threads	Steel Part #
1/2"	1/2" - 14 NPTF	H4F4-HV

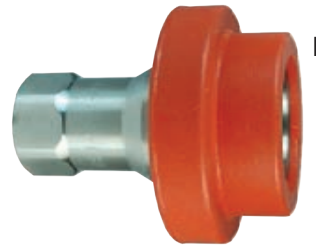

**ISO-B Food Grade Silicone Flanged Female Threaded Couplers**

Body Size	Female Threads	303 Stainless Steel Part #	316 Stainless Steel Part #
1/2"	1/2" - 14 NPTF	D-4HF4-S-FSB	D-4HF4-SS-FSB

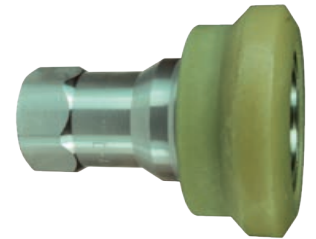

**ISO-B Food Grade Nylon Flanged Female Threaded Couplers**

Body Size	Female Threads	303 Stainless Steel Part #	316 Stainless Steel Part #
1/2"	1/2" - 14 NPTF	D-4HF4-S-FNS	D-4HF4-SS-FNS



**ISO-B Food Grade Female Threaded Plugs**

Body Size	Female Threads	Steel Part #	303 Stainless Steel Part #	316 Stainless Steel Part #
1/2"	1/2" - 14 NPTF	D-H4F4-SV-8	D-H4F4-S	D-H4F4-SS

K

## H-Series Hydraulic Couplings

### ISO-B Dust Caps / Plugs

Body Size	Nitrile Part #
1/8"	1HDP
	H1DC
1/4"	2HDP-H2DC
3/8"	3HDP-H3DC
1/2"	4HDP-H4DC
3/4"	6HDP-H6DC
1"	8HDP-H8DC <sup>1</sup>

<sup>1</sup> 8HDP-H8DC fits both 1" and 1-1/4" body sizes



### ISO-B Rigid Dust Plugs

Body Size	Aluminum body with steel cable Part #
1/4"	2HDP-A
3/8"	3HDP-A
1/2"	4HDP-A
3/4"	6HDP-A
1"	8HDP-A
1-1/2"	12HDP-A
2-1/2"	20HDP-A



### ISO-B Rigid Dust Caps

Body Size	Aluminum body with steel cable Part #
1/4"	H2DC-A
3/8"	H3DC-A
1/2"	H4DC-A
3/4"	H6DC-A
1"	H8DC-A
1-1/2"	H12DC-A
2-1/2"	H20DC-A



### Plug Profiles

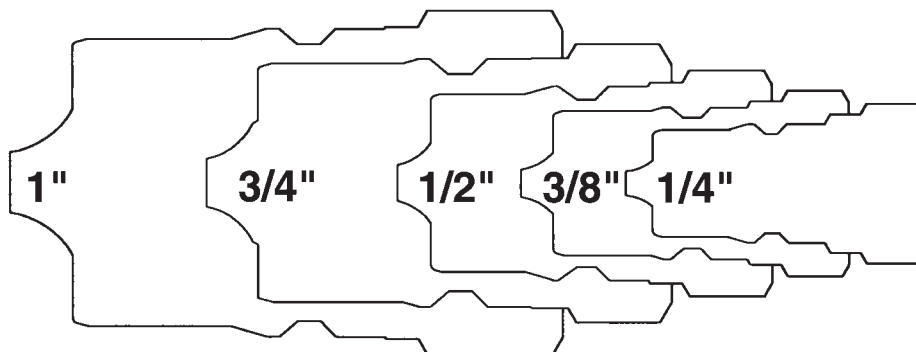

### Industry/Competitor Interchange

ISO7241-B  
 Hansen HK  
 Eaton/Aeroquip FD45  
 Parker 60  
 Faster HNV  
 Stucchi IRB/IRBO/IRBX

**H-Series Hydraulic Couplings**

**ISO-B Coupler Seal Kits**

Body Size	Coupler Material	Description	EPDM Part #	FKM Part #	Nitrile Part #
1/8"	brass, steel, 303 SS, 316 SS	two O-rings and one PTFE anti-extrusion ring	P-1H-SKIT	F-1H-SKIT	1H-SKIT
1/4"	brass, steel, 303 SS, 316 SS	two O-rings and one PTFE anti-extrusion ring	P-2H-SKIT	F-2H-SKIT	2H-SKIT
3/8"	brass, steel, 303 SS, 316 SS	two O-rings and one PTFE anti-extrusion ring	P-3H-SKIT	F-3H-SKIT	3H-SKIT
1/2"	brass, steel, 303 SS, 316 SS	two O-rings and one PTFE anti-extrusion ring	P-4H-SKIT	F-4H-SKIT	4H-SKIT
3/4"	brass, steel, 303 SS, 316 SS	two O-rings and one PTFE anti-extrusion ring	P-6H-SKIT	F-6H-SKIT	6H-SKIT
1"	brass, steel, 303 SS, 316 SS	two O-rings and one PTFE anti-extrusion ring	P-8H-SKIT	F-8H-SKIT	8H-SKIT
1-1/4"	brass, steel, 303 SS, 316 SS	adapter / valve O-ring and two body O-rings	P-10H-SKIT	F-10H-SKIT	10H-SKIT
1-1/2"	brass, steel, 303 SS, 316 SS	adapter / valve O-ring and two body O-rings	P-12H-SKIT	F-12H-SKIT	12H-SKIT





## H-Series Hydraulic Couplings

### ISO-B Repair Kits

Body Size	Coupler Material	Seal Material	Description	Part #
1/4"	steel	nitrile	steel valve assembly and retaining ring	2H-RKIT
	brass	nitrile	brass valve assembly and retaining ring	2H-BRKIT
	303 stainless	nitrile	303 SS valve assembly and retaining ring	2H-SRKIT
	316 stainless	nitrile	316 SS valve assembly and retaining ring	2H-SSRKIT
3/8"	steel	nitrile	steel valve assembly and retaining ring	3H-RKIT
	brass	nitrile	brass valve assembly and retaining ring	3H-BRKIT
	303 stainless	nitrile	303 SS valve assembly and retaining ring	3H-SRKIT
	316 stainless	nitrile	316 SS valve assembly and retaining ring	3H-SSRKIT
1/2"	steel	nitrile	steel valve assembly and retaining ring	4H-RKIT
	brass	nitrile	brass valve assembly and retaining ring	4H-BRKIT
	303 stainless	nitrile	303 SS valve assembly and retaining ring	4H-SRKIT
	316 stainless	nitrile	316 SS valve assembly and retaining ring	4H-SSRKIT
3/4"	steel	nitrile	steel valve assembly and retaining ring	6H-RKIT
	brass	nitrile	brass valve assembly and retaining ring	6H-BRKIT
	303 stainless	nitrile	303 SS valve assembly and retaining ring	6H-SRKIT
	316 stainless	nitrile	316 SS valve assembly and retaining ring	6H-SSRKIT
1"	steel	nitrile	steel valve assembly and retaining ring	8H-RKIT
	brass	nitrile	brass valve assembly and retaining ring	8H-BRKIT
	303 stainless	nitrile	303 SS valve assembly and retaining ring	8H-SRKIT
	316 stainless	nitrile	316 SS valve assembly and retaining ring	8H-SSRKIT
1-1/4"	steel	nitrile	steel valve assembly and adapter O-ring	10H-RKIT
	brass	nitrile	brass valve assembly and adapter O-ring	10H-BRKIT
	303 stainless	nitrile	303 SS valve assembly and adapter O-ring	10H-SRKIT
	316 stainless	nitrile	316 SS valve assembly and adapter O-ring	10H-SSRKIT
1-1/2"	steel	nitrile	steel valve assembly and adapter O-ring	12H-RKIT
	brass	nitrile	brass valve assembly and adapter O-ring	12H-BRKIT
	303 stainless	nitrile	303 SS valve assembly and adapter O-ring	12H-SRKIT
	316 stainless	nitrile	316 SS valve assembly and adapter O-ring	12H-SSRKIT

**K**

## H-BOP Series Hydraulic Couplings

### Application

- Designed specifically for blowout preventer systems on drilling rigs

### Features

- Steel coupler sleeves are hardened to resist deformation and maximize service life
- Individually marked with the BOP series designation
- Interchangeable with ISO7241 Series B, Eaton/Hansen HKFR-Series, DNP HNV-BOP Series

### Specification

- Pressure rating **5000 PSI** at 70°F (21°C)

### Approval

- Fire tested and Lloyd's certified to **1300°F (700°C)** in accordance with API 16D; certificate available upon request

### Blowout Preventer Safety Female Couplers



Body Size	Female Threads	Steel Part #	316 Stainless Steel Part #
3/8"	3/8" - 18 NPTF	3HF3-BOP	3HF3-SS-BOP
1/2"	1/2" - 14 NPTF	4HF4-BOP	4HF4-SS-BOP
3/4"	3/4" - 14 NPTF	6HF6-BOP	6HF6-SS-BOP
1"	1" - 11-1/2 NPTF	8HF8-BOP	8HF8-SS-BOP

### Blowout Preventer Safety Female Plugs



Body Size	Female Threads	Steel Part #	316 Stainless Steel Part #
3/8"	3/8" - 18 NPTF	H3F3-BOP	H3F3-SS-BOP
1/2"	1/2" - 14 NPTF	H4F4-BOP	H4F4-SS-BOP
3/4"	3/4" - 14 NPTF	H6F6-BOP	H6F6-SS-BOP
1"	1" - 11-1/2 NPTF	H8F8-BOP	H8F8-SS-BOP

K

## HS-Series Hydraulic Couplings

### Application

- Designed exclusively for steam applications

### Feature

- Coupler has a large plated steel sleeve designed for easier gripping with gloves

### Specifications

- Special high-temp EPDM O-rings designed for steam service providing a temperature range of -70°F to 400°F (-57°C to 204°C)
- Rated to 200 PSI gauge saturated steam 382°F (194°C)



**Warning: Do not disconnect under pressure!**

### ISO-B Steam Interchange Female Threaded Couplers

Body Size	Threads	Brass Part #	303 Stainless Steel Part #
1/4"	1/4" - 18 NPTF	2HSF2-B	2HSF2-S
	1/4" - 19 BSPP	2HSBF2-B	2HSBF2-S
3/8"	3/8" - 18 NPTF	3HSF3-B	3HSF3-S
	3/8" - 19 BSPP	3HSBF3-B	3HSBF3-S
1/2"	1/2" - 14 NPTF	4HSF4-B	4HSF4-S
	1/2" - 14 BSPP	4HSBF4-B	4HSBF4-S
3/4"	3/4" - 14 NPTF	6HSF6-B	6HSF6-S
	3/4" - 14 BSPP	6HSBF6-B	6HSBF6-S
1"	1" - 11-1/2 NPTF	8HSF8-B	8HSF8-S
	1" - 11 BSPP	8HSBF8-B	8HSBF8-S
1-1/2"	1-1/2" - 11-1/2 NPTF	PS-12HF12-B	---

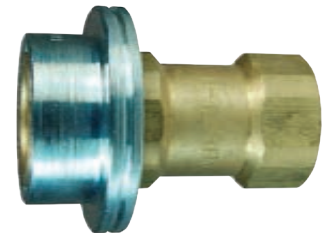

brass



303 stainless

**K**

### ISO-B Steam Interchange Female Threaded Plugs

Body Size	Threads	Steel Part #	Brass Part #	303 Stainless Steel Part #
1/4"	1/4" - 18 NPTF	HS2F2	HS2F2-B	HS2F2-S
	1/4" - 19 BSPP	HS2BF2	HS2BF2-B	HS2BF2-S
3/8"	3/8" - 18 NPTF	HS3F3	HS3F3-B	HS3F3-S
	3/8" - 19 BSPP	HS3BF3	HS3BF3-B	HS3BF3-S
1/2"	1/2" - 14 NPTF	HS4F4	HS4F4-B	HS4F4-S
	1/2" - 14 BSPP	HS4BF4	HS4BF4-B	HS4BF4-S
3/4"	3/4" - 14 NPTF	HS6F6	HS6F6-B	HS6F6-S
	3/4" - 14 BSPP	HS6BF6	HS6BF6-B	HS6BF6-S
1"	1" - 11-1/2 NPTF	HS8F8	HS8F8-B	HS8F8-S
	1" - 11 BSPP	HS8BF8	HS8BF8-B	HS8BF8-S
1-1/2"	1-1/2" - 11-1/2 NPTF	---	PS-H12F12-B	---



steel



brass



303 stainless

## K-Series Hydraulic Couplings

### Features

- Poppet style shut-off valves in both coupler and plug
- Interchangeable with Aeroquip/Eaton FD56 (5600), Parker 6600, and ISO-A 7241 interchange. See Hydraulic Profile Chart on page 491
- Contact Dixon® for additional seal material options, pressure ratings and other technical information

### Specification

- Nitrile rubber seal standard, providing a temperature range of -40°F to 250°F (-40°C to 121°C)

### ISO-A Interchange Female Threaded Couplers



4KF4 - steel



6KF6 - steel



10KF10 - steel

Body Size	Threads	Steel Part #	316 Stainless Steel Part #
1/4"	1/8" - 27 NPTF	2KF1	---
	1/4" - 18 NPTF	2KF2	2KF2-SS
	1/4" - 19 BSPP	2KBF2	2KBF2-SS
	7/16" - 20 ORB	2KOF2	---
3/8"	3/8" - 18 NPTF	3KF3	3KF3-SS
	3/8" - 19 BSPP	3KBF3	3KBF3-SS
	9/16" - 18 ORB	3KOF3	---
1/2"	1/2" - 14 NPTF	4KF4	4KF4-SS
	1/2" - 14 BSPP	4KBF4	4KBF4-SS
	3/4" - 16 ORB	4KOF4	---
	7/8" - 14 ORB	4KOF5	---
	3/4" - 14 NPTF	4KF6	---
3/4"	3/4" - 14 NPTF	6KF6	6KF6-SS
	3/4" - 14 BSPP	6KBF6	6KBF6-SS
	1-1/16" - 12 ORB	6KOF6	---
1"	1" - 11-1/2 NPTF	8KF8	8KF8-SS
	1" - 11 BSPP	8KBF8	8KBF8-SS
	1-5/16" - 12 ORB	8KOF8	---
1-1/4"	1-1/4" - 11-1/2 NPT	10KF10	---
	1-1/4" - 11 BSPP	10KBF10	---
1-1/2"	1-1/2" - 11-1/2 NPT	12KF12	---
	1-1/2" - 11 BSPP	12KBF12	---
2"	2" - 11-1/2 NPT	16KF16	---
	2" - 11 BSPP	16KBF16	---

### ISO-A Interchange Female Threaded Plugs



K4F4 - steel



K6F6 - steel

Body Size	Threads	Steel Part #	316 Stainless Steel Part #
1/4"	1/8" - 27 NPTF	K2F1	---
	1/4" - 18 NPTF	K2F2	K2F2-SS
	1/4" - 19 BSPP	K2BF2	K2BF2-SS
	7/16" - 20 ORB	K2OF2	---
3/8"	3/8" - 18 NPTF	K3F3	K3F3-SS
	3/8" - 19 BSPP	K3BF3	K3BF3-SS
	9/16" - 18 ORB	K3OF3	---
1/2"	1/2" - 14 NPTF	K4F4	K4F4-SS
	1/2" - 14 BSPP	K4BF4	K4BF4-SS
	3/4" - 16 ORB	K4OF4	---
	7/8" - 14 ORB	K4OF5	---
	3/4" - 14 NPTF	K4F6	---
3/4"	3/4" - 14 NPTF	K6F6	K6F6-SS
	3/4" - 14 BSPP	K6BF6	K6BF6-SS
	1-1/16" - 12 ORB	K6OF6	---
1"	1" - 11-1/2 NPTF	K8F8	K8F8-SS
	1" - 11 BSPP	K8BF8	K8BF8-SS
	1-5/16" - 12 ORB	K8OF8	---
1-1/4"	1-1/4" - 11-1/2 NPT	K10F10	---
	1-1/4" - 11 BSPP	K10BF10	---
1-1/2"	1-1/2" - 11-1/2 NPT	K12F12	---
	1-1/2" - 11 BSPP	K12BF12	---
2"	2" - 11-1/2 NPT	K16F16	---
	2" - 11 BSPP	K16BF16	---

### K-Series Hydraulic Couplings ISO-A Interchange Dust Caps / Plugs

Body Size	Nitrile Part #
1/4"	2KDP-K2DC
3/8"	3KDP-K3DC
3/4"	6KDP-K6DC
1"	8KDP-K8DC



### ISO-A Interchange Color Coded Dust Plugs

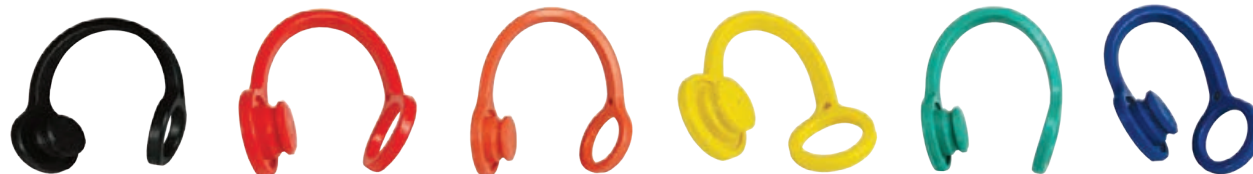

Body Size	Color	Nitrile Part #
1/2"	black	4KDP
	red	4K-R-DP
	orange	4K-O-DP
	yellow	4K-Y-DP
	green	4K-G-DP
	blue	4K-B-DP

### ISO-A Interchange Color Coded Dust Caps



Body Size	Color	Nitrile Part #
1/2"	black	K4DC
	red	K4-R-DC
	orange	K4-O-DC
	yellow	K4-Y-DC
	green	K4-G-DC
	blue	K4-B-DC

### ISO-A Interchange Coupler Seal Kits

Body Size	Coupler Style	Description	Nitrile Part #
1/4"	all	O-ring and PTFE anti-extrusion ring	2K-SKIT
3/8"	all	O-ring and PTFE anti-extrusion ring	3K-SKIT
1/2"	all	O-ring and PTFE anti-extrusion ring	4K-SKIT
3/4"	all	O-ring and PTFE anti-extrusion ring	6K-SKIT
1"	all	O-ring and PTFE anti-extrusion ring	8K-SKIT
1-1/4"	all	O-ring and PTFE anti-extrusion ring	10K-SKIT
1-1/2"	all	O-ring and PTFE anti-extrusion ring	12K-SKIT
2"	all	O-ring and PTFE anti-extrusion ring	16K-SKIT

### Plug Profiles

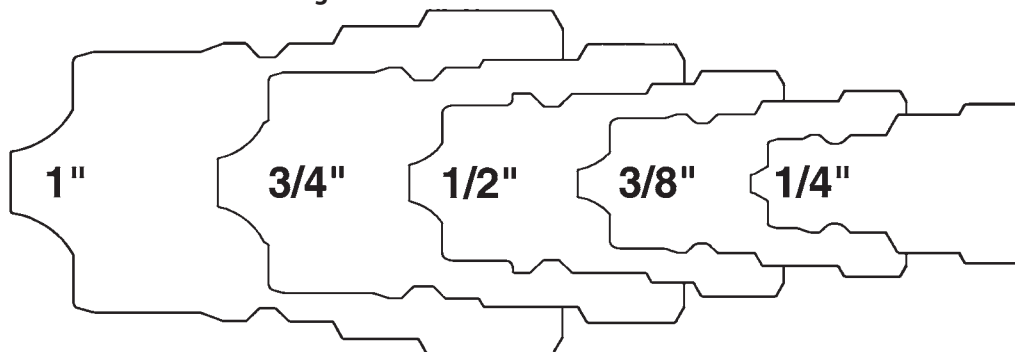

### Industry/Competitor Interchange

ISO7241-A  
Eaton/Aeroquip 5600  
Parker 6600  
Faster ANV  
Safeway S56  
Stucchi BIR

K

## AG-Series Hydraulic Couplings

### Application

- Used on construction equipment, farm implements, and most other mobile equipment

### Features

- Ball valve and poppet valve options available
- Interchangeable with Pioneer 4000 series, Faster NS/NV, Safeway S20, and Stucchi IR-series. See Hydraulic Profile Chart on page 493
- Contact Dixon® for pressure ratings and other technical information

### Specification

- Nitrile rubber seal standard, providing a temperature range of **-40°F to 250°F** (-40°C to 121°C)

#### Agricultural Ball Valve Female Threaded Couplers



Body Size	Threads	Steel Part #
1/4"	1/4" - 18 NPTF	2AGF2
3/8"	3/8" - 18 NPTF	3AGF3
1/2"	1/2" - 14 NPTF	4AGF4
	1/2" - 14 BSPP	4AGBF4
	3/4" - 16 ORB	4AGOF4
	7/8" - 14 ORB	4AGOF5
	3/4" - 14 NPTF	4AGF6
3/4"	3/4" - 14 NPTF	6AGF6
1"	1" - 11-1/2 NPTF	8AGF8

#### Agricultural Poppet Valve Female Threaded Couplers



Body Size	Threads	Steel Part #
1/4"	1/4" - 18 NPTF	2AGF2-PV
3/8"	3/8" - 18 NPTF	3AGF3-PV
1/2"	1/2" - 14 NPTF	4AGF4-PV
	1/2" - 14 BSPP	4AGBF4-PV
	3/4" - 16 ORB	4AGOF4-PV
	7/8" - 14 ORB	4AGOF5-PV
	3/4" - 14 NPTF	4AGF6-PV
3/4"	3/4" - 14 NPTF	6AGF6-PV
1"	1" - 11-1/2 NPTF	8AGF8-PV

#### Agricultural Push-Pull Ball Valve Female Threaded Couplers



Body Size	Threads	Steel Part #
3/8"	3/8" - 18 NPTF	3AGF3-PS
	1/2" - 14 NPTF	4AGF4-PS
1/2"	3/8" - 16 ORB	4AGOF4-PS
	7/8" - 14 ORB	4AGOF5-PS
	3/4" - 14 NPTF	4AGF6-PS
3/4"	3/4" - 14 NPTF	6AGF6-PS

#### Agricultural Push-Pull Poppet Valve Female Threaded Couplers



Body Size	Threads	Steel Part #
3/8"	3/8" - 18 NPTF	3AGF3-PV-PS
	1/2" - 14 NPTF	4AGF4-PV-PS
1/2"	3/4" - 16 ORB	4AGOF4-PV-PS
	7/8" - 14 ORB	4AGOF5-PV-PS
	3/4" - 14 NPTF	4AGF6-PV-PS
3/4"	3/4" - 14 NPTF	6AGF6-PV-PS

### AG-Series Hydraulic Couplings

#### Agricultural Ball Valve Female Threaded Plugs

Body Size	Threads	Steel Part #
1/4"	1/4" - 18 NPTF	AG2F2
3/8"	3/8" - 18 NPTF	AG3F3
1/2"	1/2" - 14 NPTF	AG4F4
	1/2" - 14 BSPP	AG4BF4
	3/4" - 16 ORB	AG40F4
	7/8" - 14 ORB	AG40F5
	3/4" - 14 NPTF	AG4F6
3/4"	3/4" - 14 NPTF	AG6F6
1"	1" - 11-1/2 NPTF	AG8F8



#### Agricultural Poppet Valve Female Threaded Plugs

Body Size	Threads	Steel Part #
1/4"	1/4" - 18 NPTF	AG2F2-PV
3/8"	3/8" - 18 NPTF	AG3F3-PV
1/2"	1/2" - 14 NPTF	AG4F4-PV
	1/2" - 14 BSPP	AG4BF4-PV
	3/4" - 16 ORB	AG40F4-PV
	7/8" - 14 ORB	AG40F5-PV
	3/4" - 14 NPTF	AG4F6-PV
3/4"	3/4" - 14 NPTF	AG6F6-PV
1"	1" - 11-1/2 NPTF	AG8F8-PV



#### AG-Series Agricultural Interchange Connect Under Residual Pressure Plug (Female Threads)

Body Size	Part Detail			Length		Maximum O.D.		Hex Inch
	Part #	Threads	Material	Inch	mm	Inch	mm	
1/2"	AGE4F4-PV	1/2" - 14 NPTF	steel	2.03	51.56	1.20	30.48	1-1/16"
	AGE40F4-PV	3/4" - 16 ORB						

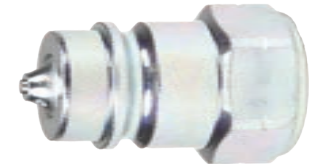

#### Agricultural Dust Plugs

Body Size	Elastomer Part #
1/4"	2AGDP
3/8"	3AGDP
1/2"	For 1/2" Please refer to the color coded K-series dust plugs on pg. 491
3/4"	6AGDP
1"	8AGDP



#### Agricultural Dust Caps

Body Size	Elastomer Part #
1/4"	AG2DC
3/8"	AG3DC
1/2"	For 1/2" Please refer to the color coded K-series dust caps on pg. 491
3/4"	AG6DC
1"	AG8DC



#### Plug Profiles

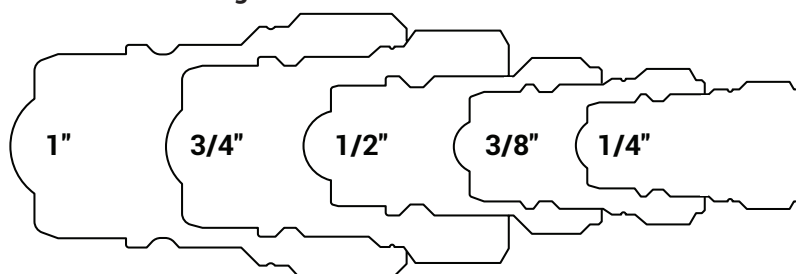

#### Industry/Competitor Interchange

Parker/Pioneer 4000  
Safeway S20  
Faster NS/NV  
Stucchi IR

### V-Series Hydraulic Couplings

**Features**

- General purpose hydraulic quick-connect provides superior flow characteristics for a variety of applications
- Interchangeable with Snap-tite H/IH Series, Foster FH/HS and Faster TNV/TNL, see Hydraulic Profile Chart on page 500
- Contact Dixon® for additional seal material options
- Contact Dixon for pressure ratings and other technical information

**Specification**

- Nitrile seal standard providing a temperature range of -40°F to 250°F (-40°C to 121°C)

**Interchange Valved Female Threaded Couplers**

Body Size	Threads	Steel Part #	Brass Part #
1/4"	1/8" - 27 NPTF	2VF1	---
	1/4" - 18 NPTF	2VF2	2VBF2-B
	1/4" - 19 BSPP	2VBF2	2VBF2-B
	7/16" - 20 ORB	2VOF2	---
3/8"	3/8" - 18 NPTF	3VF3	3VF3-B
	3/8" - 19 BSPP	3VBF3	3VBF3-B
	9/16" - 18 ORB	3VOF3	---
	1/2" - 14 NPTF	3VF4	---
1/2"	1/2" - 14 NPTF	4VF4	4VF4-B
	1/2" - 14 BSPP	4VBF4	4VBF4-B
	3/4" - 16 ORB	4VOF4	---
	3/4" - 14 NPTF	4VF6	---
3/4"	3/4" - 14 NPTF	6VF6	6VF6-B
	3/4" - 14 BSPP	6VBF6	6VBF6-B
	1-1/16" - 12 ORB	6VOF6	---
1"	1" - 11-1/2 NPTF	8VF8	8VF8-B
	1" - 11 BSPP	8VBF8	8VBF8-B
	1-5/16" - 12 ORB	8VOF8	---
1-1/4"	1-1/4" - 11-1/2 NPTF	10VF10	10VF10-B
	1-1/4" - 11 BSPP	10VBF10	10VBF10-B
	1-5/8" - 12 ORB	10VOF10	---
1-1/2"	1-1/2" - 11-1/2 NPTF	12VF12	12VF12-B
	1-1/2" - 11 BSPP	12VBF12	12VBF12-B
	1-7/8" - 12 ORB	12VOF12	---
2"	2" - 11-1/2 NPTF	16VF16	16VF16-B
	2" - 11 BSPP	16VBF16	16VBF16-B

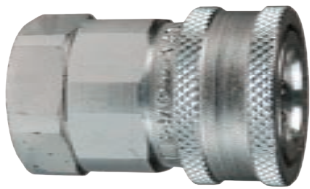

steel

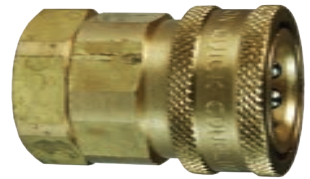

brass

K

Body Size	Threads	316 Stainless Steel Part #
1/4"	1/4" - 18 NPTF	2VF2-SS
	1/4" - 19 BSPP	2VBF2-SS
3/8"	3/8" - 18 NPTF	3VF3-SS
	3/8" - 19 BSPP	3VBF3-SS
1/2"	1/2" - 14 NPTF	4VF4-SS
	1/2" - 14 BSPP	4VBF4-SS
3/4"	3/4" - 14 NPTF	6VF6-SS
	3/4" - 14 BSPP	6VBF6-SS
1"	1" - 11-1/2 NPTF	8VF8-SS
	1" - 11 BSPP	8VBF8-SS
1-1/4"	1-1/4" - 11-1/2 NPTF	10VF10-SS
	1-1/4" - 11 BSPP	10VBF10-SS
1-1/2"	1-1/2" - 11-1/2 NPTF	12VF12-SS
	1-1/2" - 11 BSPP	12VBF12-SS
2"	2" - 11-1/2 NPTF	16VF16-SS
	2" - 11 BSPP	16VBF16-SS



stainless steel



### V-Series Hydraulic Couplings

#### Interchange Valved Male Threaded Couplers

Body Size	Threads	Steel Part #	Brass Part #	316 Stainless Steel Part #
1/4"	1/8" - 27 NPTF	2VM1	---	---
	1/4" - 18 NPTF	2VM2	2VM2-B	2VM2-SS
	7/16" - 20 JIC	2VJM2	---	---
3/8"	3/8" - 18 NPTF	3VM3	3VM3-B	3VM3-SS
	9/16" - 18 JIC	3VJM3	---	---
1/2"	1/2" - 14 NPTF	4VM4	4VM4-B	4VM4-SS
	3/4" - 16 JIC	4VJM4	---	---
3/4"	3/4" - 14 NPTF	6VM6	6VM6-B	6VM6-SS
	1-1/16" - 12 JIC	6VJM6	---	---
1"	1" - 11-1/2 NPTF	8VM8	8VM8-B	8VM8-SS
	1-5/16" - 12 JIC	8VJM8	---	---
1-1/4"	1-1/4" - 11-1/2 NPTF	10VM10	10VM10-B	10VM10-SS
	1-5/8" - 12 JIC	10VJM10	---	---
1-1/2"	1-1/2" - 11-1/2 NPTF	12VM12	12VM12-B	12VM12-SS
2"	2" - 11-1/2 NPTF	16VM16	16VM16-B	16VM16-SS

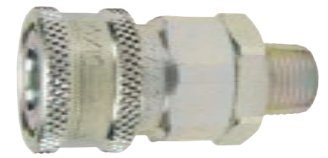

steel



brass



316 stainless



steel - JIC



#### Interchange Valved Male Threaded Plugs

Body Size	Threads	Steel Part #	Brass Part #	316 Stainless Steel Part #
1/4"	1/8" - 27 NPTF	V2M1	---	---
	1/4" - 18 NPTF	V2M2	V2M2-B	V2M2-SS
	7/16" - 20 JIC	V2JM2	---	---
3/8"	3/8" - 18 NPTF	V3M3	V3M3-B	V3M3-SS
	9/16" - 18 JIC	V3JM3	---	---
1/2"	1/2" - 14 NPTF	V4M4	V4M4-B	V4M4-SS
	3/4" - 16 JIC	V4JM4	---	---
3/4"	3/4" - 14 NPTF	V6M6	V6M6-B	V6M6-SS
	1-1/16" - 12 JIC	V6JM6	---	---
1"	1" - 11-1/2 NPTF	V8M8	V8M8-B	V8M8-SS
	1-5/16" - 12 JIC	V8JM8	---	---
1-1/4"	1-1/4" - 11-1/2 NPTF	V10M10	V10M10-B	V10M10-SS
	1-5/8" - 12 JIC	V10JM10	---	---
1-1/2"	1-1/2" - 11-1/2 NPTF	V12M12	V12M12-B	V12M12-SS
2"	2" - 11-1/2 NPTF	V16M16	V16M16-B	V16M16-SS



steel



brass



316 stainless



steel

### V-Series Hydraulic Couplings

#### Interchange Valved Female Threaded Plugs



steel



brass

Body Size	Threads	Steel Part #	Brass Part #
1/4"	1/8" - 27 NPTF	V2F1	---
	1/4" - 18 NPTF	V2F2	V2F2-B
	1/4" - 19 BSPP	V2BF2	V2BF2-B
	7/16" - 20 ORB	V2OF2	---
3/8"	3/8" - 18 NPTF	V3F3	V3F3-B
	3/8" - 19 BSPP	V3BF3	V3BF3-B
	9/16" - 18 ORB	V3OF3	---
	1/2" - 14 NPTF	V3F4	---
1/2"	1/2" - 14 NPTF	V4F4	V4F4-B
	1/2" - 14 BSPP	V4BF4	V4BF4-B
	3/4" - 16 ORB	V4OF4	---
	3/4" - 14 NPTF	V4F6	---
3/4"	3/4" - 14 NPTF	V6F6	V6F6-B
	3/4" - 14 BSPP	V6BF6	V6BF6-B
	1-1/16" - 12 ORB	V6OF6	---
	1" - 11-1/2 NPTF	V8F8	V8F8-B
1"	1" - 11 BSPP	V8BF8	V8BF8-B
	1-5/16" - 12 ORB	V8OF8	---
	1-1/4" - 11-1/2 NPTF	V10F10	V10F10-B
	1-1/4" - 11 BSPP	V10BF10	V10BF10-B
1-1/4"	1-5/8" - 12 ORB	V10OF10	---
	1-1/2" - 11-1/2 NPTF	V12F12	V12F12-B
	1-1/2" - 11 BSPP	V12BF12	V12BF12-B
1-1/2"	1-7/8" - 12 ORB	V12OF12	---
	2" - 11-1/2 NPTF	V16F16	V16F16-B
	2" - 11 BSPP	V16BF16	V16BF16-B



stainless steel

Body Size	Threads	316 Stainless Steel Part #
1/4"	1/4" - 18 NPTF	V2F2-SS
	1/4" - 19 BSPP	V2BF2-SS
3/8"	3/8" - 18 NPTF	V3F3-SS
	3/8" - 19 BSPP	V3BF3-SS
1/2"	1/2" - 14 NPTF	V4F4-SS
	1/2" - 14 BSPP	V4BF4-SS
3/4"	3/4" - 14 NPTF	V6F6-SS
	3/4" - 14 BSPP	V6BF6-SS
1"	1" - 11-1/2 NPTF	V8F8-SS
	1" - 11 BSPP	V8BF8-SS
1-1/4"	1-1/4" - 11-1/2 NPTF	V10F10-SS
	1-1/4" - 11 BSPP	V10BF10-SS
1-1/2"	1-1/2" - 11-1/2 NPTF	V12F12-SS
	1-1/2" - 11 BSPP	V12BF12-SS
2"	2" - 11-1/2 NPTF	V16F16-SS
	2" - 11 BSPP	V16BF16-SS

K

### V-Series Hydraulic Couplings

#### Interchange Unvalved Female Threaded Couplers

Body Size	Threads	Steel Part #	Brass Part #
1/4"	1/4" - 18 NPTF	2VF2-E	2VF2-B-E
	1/4" - 19 BSPP	2VBF2-E	2VBF2-B-E
3/8"	3/8" - 18 NPTF	3VF3-E	3VF3-B-E
	3/8" - 19 BSPP	3VBF3-E	3VBF3-B-E
1/2"	1/2" - 14 NPTF	4VF4-E	4VF4-B-E
	1/2" - 14 BSPP	4VBF4-E	4VBF4-B-E
3/4"	3/4" - 14 NPTF	6VF6-E	6VF6-B-E
	3/4" - 14 BSPP	6VBF6-E	6VBF6-B-E
1"	1" - 11-1/2 NPTF	8VF8-E	8VF8-B-E
	1" - 11 BSPP	8VBF8-E	8VBF8-B-E
1-1/4"	1-1/4" - 11-1/2 NPTF	10VF10-E	10VF10-B-E
	1-1/4" - 11 BSPP	10VBF10-E	10VBF10-B-E
1-1/2"	1-1/2" - 11-1/2 NPTF	12VF12-E	12VF12-B-E
2"	2" - 11-1/2 NPTF	16VF16-E	16VF16-B-E

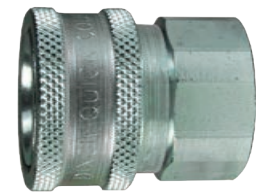

steel



brass

Body Size	Threads	316 Stainless Steel Part #
1/4"	1/4" - 18 NPTF	2VF2-SS-E
	1/4" - 19 BSPP	2VBF2-SS-E
3/8"	3/8" - 18 NPTF	3VF3-SS-E
	3/8" - 19 BSPP	3VBF3-SS-E
1/2"	1/2" - 14 NPTF	4VF4-SS-E
	1/2" - 14 BSPP	4VBF4-SS-E
3/4"	3/4" - 14 NPTF	6VF6-SS-E
	3/4" - 14 BSPP	6VBF6-SS-E
1"	1" - 11-1/2 NPTF	8VF8-SS-E
	1" - 11 BSPP	8VBF8-SS-E
1-1/4"	1-1/4" - 11-1/2 NPTF	10VF10-SS-E
	1-1/4" - 11 BSPP	10VBF10-SS-E
1-1/2"	1-1/2" - 11-1/2 NPTF	12VF12-SS-E
2"	2" - 11-1/2 NPTF	16VF16-SS-E



316 stainless

**K**

V-Series Hydraulic Couplings



steel



brass



316 stainless

Interchange Unvalved Male Threaded Couplers

Body Size	Threads	Steel Part #	Brass Part #	316 Stainless Steel Part #
1/4"	1/4" - 18 NPTF	2VM2-E	2VM2-B-E	2VM2-SS-E
3/8"	3/8" - 18 NPTF	3VM3-E	3VM3-B-E	3VM3-SS-E
1/2"	1/2" - 14 NPTF	4VM4-E	4VM4-B-E	4VM4-SS-E
3/4"	3/4" - 14 NPTF	6VM6-E	6VM6-B-E	6VM6-SS-E
1"	1" - 11-1/2 NPTF	8VM8-E	8VM8-B-E	8VM8-SS-E
1 1/4"	1-1/4" - 11-1/2 NPTF	10VM10-E	---	10VM10-SS-E
1-1/2"	1-1/2" - 11-1/2 NPTF	12VM12-E	---	12VM12-SS-E
2"	2" - 11-1/2 NPTF	16VM16-E	---	16VM16-SS-E



steel



brass



316 stainless

Interchange Unvalved Male Threaded Plugs

Body Size	Threads	Steel Part #	Brass Part #	316 Stainless Steel Part #
1/4"	1/4" - 18 NPTF	V2M2-E	V2M2-B-E	V2M2-SS-E
3/8"	3/8" - 18 NPTF	V3M3-E	V3M3-B-E	V3M3-SS-E
1/2"	1/2" - 14 NPTF	V4M4-E	V4M4-B-E	V4M4-SS-E
3/4"	3/4" - 14 NPTF	V6M6-E	V6M6-B-E	V6M6-SS-E
1"	1" - 11-1/2 NPTF	V8M8-E	V8M8-B-E	V8M8-SS-E
1-1/4"	1-1/4" - 11-1/2 NPTF	V10M10-E	---	V10M10-SS-E
1-1/2"	1-1/2" - 11-1/2 NPTF	V12M12-E	---	V12M12-SS-E
2"	2" - 11-1/2 NPTF	V16M16-E	---	V16M16-SS-E

## V-Series Hydraulic Couplings

### Interchange Unvalved Female Threaded Plugs

Body Size	Threads	Steel Part #	Brass Part #
1/4"	1/4" - 18 NPTF	V2F2-E	V2F2-B-E
	1/4" - 19 BSPP	V2BF2-E	V2BF2-B-E
3/8"	3/8" - 18 NPTF	V3F3-E	V3F3-B-E
	3/8" - 19 BSPP	V3BF3-E	V3BF3-B-E
1/2"	1/2" - 14 NPTF	V4F4-E	V4F4-B-E
	1/2" - 14 BSPP	V4BF4-E	V4BF4-B-E
3/4"	3/4" - 14 NPTF	V6F6-E	V6F6-B-E
	3/4" - 14 BSPP	V6BF6-E	V6BF6-B-E
1"	1" - 11-1/2 NPTF	V8F8-E	V8F8-B-E
	1" - 11 BSPP	V8BF8-E	V8BF8-B-E
1-1/4"	1-1/4" - 11-1/2 NPTF	V10F10-E	V10F10-B-E
	1-1/4" - 11 BSPP	V10BF10-E	V10BF10-B-E
1-1/2"	1-1/2" - 11-1/2 NPTF	V12F12-E	V12F12-B-E
2"	2" - 11-1/2 NPTF	V16F16-E	V16F16-B-E



steel



brass

Body Size	Threads	316 Stainless Steel Part #
1/4"	1/4" - 18 NPTF	V2F2-SS-E
	1/4" - 19 BSPP	V2BF2-SS-E
3/8"	3/8" - 18 NPTF	V3F3-SS-E
	3/8" - 19 BSPP	V3BF3-SS-E
1/2"	1/2" - 14 NPTF	V4F4-SS-E
	1/2" - 14 BSPP	V4BF4-SS-E
3/4"	3/4" - 14 NPTF	V6F6-SS-E
	3/4" - 14 BSPP	V6BF6-SS-E
1"	1" - 11-1/2 NPTF	V8F8-SS-E
	1" - 11 BSPP	V8BF8-SS-E
1-1/4"	1-1/4" - 11-1/2 NPTF	V10F10-SS-E
	1-1/4" - 11 BSPP	V10BF10-SS-E
1-1/2"	1-1/2" - 11-1/2 NPTF	V12F12-SS-E
2"	2" - 11-1/2 NPTF	V16F16-SS-E



K

V-Series Hydraulic Couplings

Interchange Dust Caps / Plugs



Body Size	Nitrile Part #
1/4"	1HDP
	V2DC
3/8"	3VDP-V3DC
1/2"	3KDP-K3DC
3/4"	6VDP-V6DC
1"	8VDP-V8DC

Interchange Dust Plugs



Body Size	Aluminum body with steel cable Part #
1/4"	2VDP-A
3/8"	3VDP-A
1/2"	4VDP-A
3/4"	6VDP-A
1"	8VDP-A
1-1/4"	10VDP-A
1-1/2"	12VDP-A
2"	16VDP-A

Interchange Dust Caps



Body Size	Aluminum body with steel cable Part #
1/4"	V2DC-A
3/8"	V3DC-A
1/2"	V4DC-A
3/4"	V6DC-A
1"	V8DC-A
1-1/4"	V10DC-A
1-1/2"	V12DC-A
2"	V16DC-A

Plug Profiles

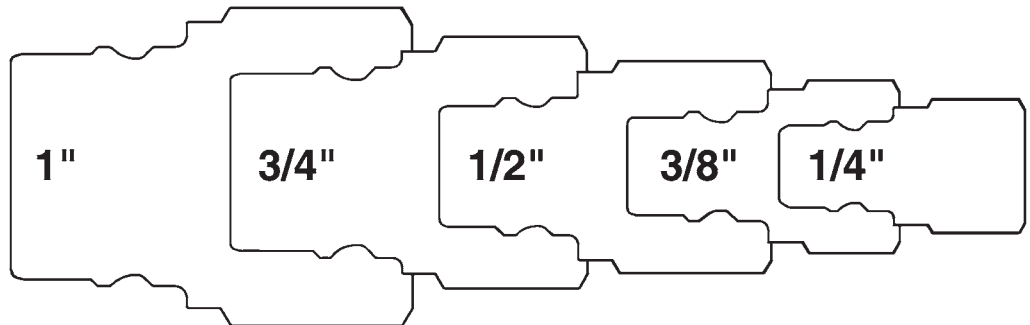

Industry/Competitor Interchange

Snap-tite H  
Faster TNV  
MIL-C-51234

K

## V-Series Hydraulic Couplings

### Interchange Coupler Seal Kits

Body Size	Coupler Style	Description	Nitrile Part #
1/4"	all	body / adapter O-rings and PTFE back-up	2V-SKIT
3/8"	all	body / adapter O-rings and PTFE back-up	3V-SKIT
1/2"	all	body / adapter O-rings and PTFE back-up	4V-SKIT
3/4"	all	body / adapter O-rings and PTFE back-up	6V-SKIT
1"	all	body / adapter O-rings and PTFE back-up	8V-SKIT
1-1/4"	all	body / adapter/valve O-rings and back-up	10V-SKIT
1-1/2"	all	body / adapter/valve O-rings and back-up	12V-SKIT
2"	all	body / adapter/valve O-rings and back-up	16V-SKIT

Body Size	Coupler Style	Description	FKM Part #
1/4"	all	body / adapter O-rings and PTFE back-up	F-2V-SKIT
3/8"	all	body / adapter O-rings and PTFE back-up	F-3V-SKIT
1/2"	all	body / adapter O-rings and PTFE back-up	F-4V-SKIT
3/4"	all	body / adapter O-rings and PTFE back-up	F-6V-SKIT
1"	all	body / adapter O-rings and PTFE back-up	F-8V-SKIT
1-1/4"	all	body / adapter/valve O-rings and back-up	F-10V-SKIT
1-1/2"	all	body / adapter/valve O-rings and back-up	F-12V-SKIT
2"	all	body / adapter/valve O-rings and back-up	F-16V-SKIT

Body Size	Coupler Style	Description	EPDM Part #
1/4"	all	body / adapter O-rings and PTFE back-up	P-2V-SKIT
3/8"	all	body / adapter O-rings and PTFE back-up	P-3V-SKIT
1/2"	all	body / adapter O-rings and PTFE back-up	P-4V-SKIT
3/4"	all	body / adapter O-rings and PTFE back-up	P-6V-SKIT
1"	all	body / adapter O-rings and PTFE back-up	P-8V-SKIT
1-1/4"	all	body / adapter/valve O-rings and back-up	P-10V-SKIT
1-1/2"	all	body / adapter/valve O-rings and back-up	P-12V-SKIT
2"	all	body / adapter/valve O-rings and back-up	P-16V-SKIT

K

### V-Series Hydraulic Couplings

#### Interchange Coupler Repair Kits

Body Size	Coupler Material	Seal Material	Description	Part #
1/4"	steel	nitrile	steel valve assembly and adapter O-ring	2V-RKIT
	brass	nitrile	brass valve assembly and adapter O-ring	2V-BRKIT
	316 stainless	nitrile	316 SS valve assembly and adapter O-ring	2V-SSRKIT
3/8"	steel	nitrile	steel valve assembly and adapter O-ring	3V-RKIT
	brass	nitrile	brass valve assembly and adapter O-ring	3V-BRKIT
	316 stainless	nitrile	316 SS valve assembly and adapter O-ring	3V-SSRKIT
1/2"	steel	nitrile	steel valve assembly and adapter O-ring	4V-RKIT
	brass	nitrile	brass valve assembly and adapter O-ring	4V-BRKIT
	316 stainless	nitrile	316 SS valve assembly and adapter O-ring	4V-SSRKIT
3/4"	steel	nitrile	steel valve assembly and adapter O-ring	6V-RKIT
	brass	nitrile	brass valve assembly and adapter O-ring	6V-BRKIT
	316 stainless	nitrile	316 SS valve assembly and adapter O-ring	6V-SSRKIT
1"	steel	nitrile	steel valve assembly and adapter O-ring	8V-RKIT
	brass	nitrile	brass valve assembly and adapter O-ring	8V-BRKIT
	316 stainless	nitrile	316 SS valve assembly and adapter O-ring	8V-SSRKIT
1-1/4"	steel	nitrile	steel valve assembly and adapter O-ring	140030-10
	316 stainless	nitrile	316 SS valve assembly and adapter O-ring	140032-10
1-1/2"	steel	nitrile	steel valve assembly and adapter O-ring	140030-12
	316 stainless	nitrile	316 SS valve assembly and adapter O-ring	140032-12
2"	steel	nitrile	steel valve assembly and adapter O-ring	140030-16
	316 stainless	nitrile	316 SS valve assembly and adapter O-ring	140032-16

#### Interchange Plug Repair Kits

Body Size	Coupler Material	Seal Material	Description	Part #
1/4"	steel	nitrile	steel valve assembly and adapter O-ring	V2-RKIT
	brass	nitrile	brass valve assembly and adapter O-ring	V2-BRKIT
	316 stainless	nitrile	316 SS valve assembly and adapter O-ring	V2-SSRKIT
3/8"	steel	nitrile	steel valve assembly and adapter O-ring	V3-RKIT
	brass	nitrile	brass valve assembly and adapter O-ring	V3-BRKIT
	316 stainless	nitrile	316 SS valve assembly and adapter O-ring	V3-SSRKIT
1/2"	steel	nitrile	steel valve assembly and adapter O-ring	V4-RKIT
	brass	nitrile	brass valve assembly and adapter O-ring	V4-BRKIT
	316 stainless	nitrile	316 SS valve assembly and adapter O-ring	V4-SSRKIT
3/4"	steel	nitrile	steel valve assembly and adapter O-ring	V6-RKIT
	brass	nitrile	brass valve assembly and adapter O-ring	V6-BRKIT
	316 stainless	nitrile	316 SS valve assembly and adapter O-ring	V6-SSRKIT
1"	steel	nitrile	steel valve assembly and adapter O-ring	V8-RKIT
	brass	nitrile	brass valve assembly and adapter O-ring	V8-BRKIT
	316 stainless	nitrile	316 SS valve assembly and adapter O-ring	V8-SSRKIT
1-1/4"	steel	nitrile	steel valve assembly and adapter O-ring	140030-10
	316 stainless	nitrile	316 SS valve assembly and adapter O-ring	140032-10
1-1/2"	steel	nitrile	steel valve assembly and adapter O-ring	140030-12
	316 stainless	nitrile	316 SS valve assembly and adapter O-ring	140032-12
2"	steel	nitrile	steel valve assembly and adapter O-ring	140030-16
	316 stainless	nitrile	316 SS valve assembly and adapter O-ring	140032-16



## TR-Series Hydraulic Couplings

### Features

- Interchangeable with TEMA European, 3800, 5000, 7500, 10000 series
- Valve seals are crimped in place to maintain integrity during excessive flow conditions and pressurized connection
- Contact Dixon® for pressure ratings and other technical information

### Specification

- Nitrile rubber seal standard, providing a temperature range of -40°F to 250°F (-40°C to 121°C)

### Tema European Female Threaded Couplers

Body Size	Threads	Steel Part #
3/8"	3/8" - 18 NPTF	3TRF3
	3/8" - 19 BSPP	3TRBF3
1/2"	1/2" - 14 NPTF	4TRF4
	1/2" - 14 BSPP	4TRBF4
3/4"	3/4" - 14 NPTF	6TRF6
	3/4" - 14 BSPP	6TRBF6
1"	1" - 11-1/2 NPTF	8TRF8
	1" - 11 BSPP	8TRBF8



### Tema European Female Threaded Plugs

Body Size	Threads	Steel Part #
3/8"	3/8" - 18 NPTF	TR3F3
	3/8" - 19 BSPP	TR3BF3
1/2"	1/2" - 14 NPTF	TR4F4
	1/2" - 14 BSPP	TR4BF4
3/4"	3/4" - 14 NPTF	TR6F6
	3/4" - 14 BSPP	TR6BF6
1"	1" - 11-1/2 NPTF	TR8F8
	1" - 11 BSPP	TR8BF8



**K**

### Tema European Coupler Seal Kits

Body Size	Coupler Style	Seal Kit Contents	Nitrile Part #
3/8"	all	two O-rings and one PTFE back-up ring	3TR-SKIT
1/2"	all	two O-rings and one PTFE back-up ring	4TR-SKIT
3/4"	all	two O-rings and one PTFE back-up ring	6TR-SKIT
1"	all	two O-rings and one PTFE back-up ring	8TR-SKIT



### Industry/Competitor Interchange

TEMA European Interchange  
TEMA 3800, 5000, 7500,  
1000 Series  
CEJN Series 525

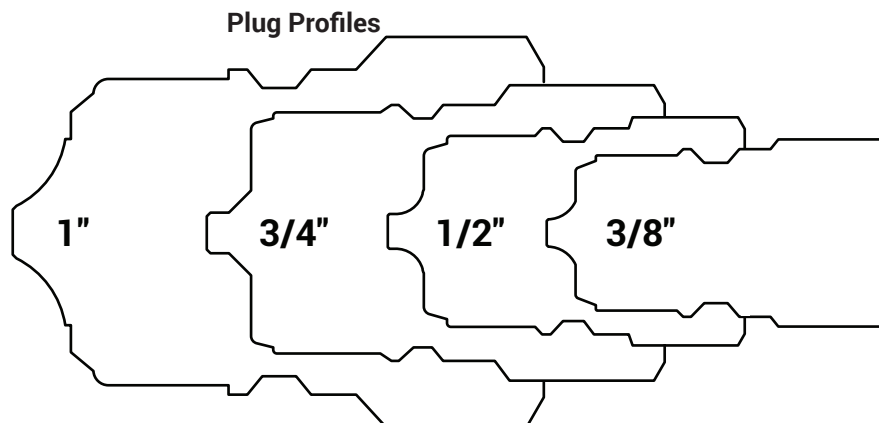

Please contact Dixon for dust caps and dust plugs.

## HT-Series Correct Connect®



Correct Connect shown on HT-Series couplers and plugs.

### Challenges

- Time wasted identifying proper hose routing
- Equipment damage due to incorrect connections
- Product cross-contamination

### Solution

- HT-Series Correct Connect color bands
- Easily identify seals, materials, or sizes for application
- Helps with preventative maintenance schedules
- Reduces setup time for more efficient hose routing

### Applications

- Used in equipment for oilfield, industrial hydraulic, and construction

### Sizes

- Body: 1/4" to 1"

### Features

- Blue band standard; color bands sold separately (orange, green, yellow, and red)
- No special tools required - field replaceable
- Also available in connect-under-pressure HTE-Series and HTZ-Series

### Materials

- Steel and 316 stainless steel
- Nitrile/polyurethane seals standard; additional seal materials are available
- Polyurethane color bands

### Specifications

- Temperature range: -40°F to 212°F (-40°C to 100°C) with standard seals
- 5,000 PSI from 1/4" - 1"

### Approvals

- ISO16028 interchange
- Interchangeable with Parker FEM, Stucchi FIRG - Series A, Faster FFH, Eaton FF - FD89, Holmbury HQ

K



Body Size	Description	Blue Part #	Orange Part #	Green Part #	Yellow Part #	Red Part #
1/4"	coupler band	2HTBAND-B	2HTBAND-O	2HTBAND-G	2HTBAND-Y	2HTBAND-R
	plug band	HT2BAND-B	HT2BAND-O	HT2BAND-G	HT2BAND-Y	HT2BAND-R
3/8"	coupler band	3HTBAND-B	3HTBAND-O	3HTBAND-G	3HTBAND-Y	3HTBAND-R
	plug band	HT3BAND-B	HT3BAND-O	HT3BAND-G	HT3BAND-Y	HT3BAND-R
1/2"	coupler band	4HTBAND-B	4HTBAND-O	4HTBAND-G	4HTBAND-Y	4HTBAND-R
	plug band	HT4BAND-B	HT4BAND-O	HT4BAND-G	HT4BAND-Y	HT4BAND-R
5/8"	coupler band	5HTBAND-B	5HTBAND-O	5HTBAND-G	5HTBAND-Y	5HTBAND-R
	plug band	HT5BAND-B	HT5BAND-O	HT5BAND-G	HT5BAND-Y	HT5BAND-R
3/4"	coupler band	6HTBAND-B	6HTBAND-O	6HTBAND-G	6HTBAND-Y	6HTBAND-R
	plug band	HT6BAND-B	HT6BAND-O	HT6BAND-G	HT6BAND-Y	HT6BAND-R
1"	coupler band	8HTBAND-B	8HTBAND-O	8HTBAND-G	8HTBAND-Y	8HTBAND-R
	plug band	HT8BAND-B	HT8BAND-O	HT8BAND-G	HT8BAND-Y	HT8BAND-R

## HT-Series Correct Connect®

### Features

- Minimizes fluid loss resulting in a cleaner, safe work environment
- Automatic, push-to-connect couplings provide high flow with minimal pressure drop assuring maximum hydraulic system performance
- To reduce the possibility of accidental disconnect, the sleeve lock safety feature requires turning the collar to unlock the coupling
- Contact Dixon® for additional seal material options, pressure ratings, and other technical information

### Approvals

- Conforms to ISO16028 interchange standard; interchangeable with Eaton/Hansen FF, Parker FEM, Snap-tite 74, Faster FFH/2FFN/2FFI, Stucchi A/FIRG, and Holmbury HQ/A/FIMC

### ISO16028 Flushface Female Threaded Couplers

Body Size	Threads	Steel Part #	316 Stainless Steel Part #
1/4"	1/4" - 18 NPTF	2HTF2	---
	1/4" - 19 BSPP	2HTBF2	---
	9/16" - 18 ORB	2HTOF3	---
3/8"	3/8" - 18 NPTF	3HTF3	3HTF3-SS
	3/8" - 19 BSPP	3HTBF3	3HTBF3-SS
	9/16" - 18 ORB	3HTOF3	---
	1/2" - 14 NPTF	3HTF4	3HTF4-SS
	1/2" - 14 BSPP	3HTBF4	3HTBF4-SS
	3/4" - 16 ORB	3HTOF4	---
1/2"	1/2" - 14 NPTF	4HTF4	4HTF4-SS
	1/2" - 14 BSPP	4HTBF4	4HTBF4-SS
	3/4" - 16 ORB	4HTOF4	---
	7/8" - 14 ORB	4HTOF5	---
	3/4" - 14 NPTF	4HTF6	4HTF6-SS
	3/4" - 14 BSPP	4HTBF6	4HTBF6-SS
	1-9/16" - 12 ORB	4HTOF6	---
5/8"	7/8" - 14 ORB	5HTOF5	---
	3/4" - 14 NPTF	5HTF6	5HTF6-SS
	3/4" - 14 BSPP	5HTBF6	5HTBF6-SS
	1-9/16" - 12 ORB	5HTOF6	---
3/4"	7/8" - 14 ORB	6HTOF5	---
	3/4" - 14 NPTF	6HTF6	6HTF6-SS
	3/4" - 14 BSPP	6HTBF6	6HTBF6-SS
	1-9/16" - 12 ORB	6HTOF6	---
	1" - 11-1/2 NPTF	6HTF8	6HTF8-SS
	1" - 11 BSPP	6HTBF8	6HTBF8-SS
	1-9/16" - 12 ORB	6HTOF8	---
1"	1" - 11-1/2 NPTF	8HTF8	8HTF8-SS
	1" - 11 BSPP	8HTBF8	8HTBF8-SS
	1-9/16" - 12 ORB	8HTOF8	---
	1-1/4" - 11-1/2 NPTF	8HTF10	8HTF10-SS
	1-1/4" - 11 BSPP	8HTBF10	8HTBF10-SS
	1-5/8" - 12 ORB	8HTOF10	---
1-1/2"	1-1/2" - 11-1/2 NPTF	12HTF12	---
	1-1/2" - 11 BSPP	12HTBF12	---
	1-7/8" - 12 ORB	12HTOF12	---
2"	2" - 11-1/2 NPTF	16HTF16	---
	2" - 11 BSPP	16HTBF16	---
	2-1/2" - 12 ORB	16HTOF16	---



steel



316 stainless

**K**

### ISO16028 Flushface Male Threaded Couplers

Body Size	Threads	Steel Part #
3/8"	3/8" - 18 NPTF	3HTM3
	1/2" - 14 NPTF	3HTM4
	9/16" - 18 ORB	3HTOM3
	3/4" - 16 ORB	3HTOM4
1/2"	1/2" - 14 NPTF	4HTM4



3HTM3



3HTOM4

**HT-Series Correct Connect®**

**ISO16028 Flushface Female Threaded Plugs**

Body Size	Threads	Steel Part #	316 Stainless Steel Part #
1/4"	1/4" - 18 NPTF	HT2F2	---
	1/4" - 19 BSPP	HT2BF2	---
	9/16" - 18 ORB	HT2OF3	---
3/8"	3/8" - 18 NPTF	HT3F3	HT3F3-SS
	3/8" - 19 BSPP	HT3BF3	HT3BF3-SS
	9/16" - 18 ORB	HT3OF3	---
	1/2" - 14 NPTF	HT3F4	HT3F4-SS
	1/2" - 14 BSPP	HT3BF4	HT3BF4-SS
	3/4" - 16 ORB	HT3OF4	---
1/2"	1/2" - 14 NPTF	HT4F4	HT4F4-SS
	1/2" - 14 BSPP	HT4BF4	HT4BF4-SS
	3/4" - 16 ORB	HT4OF4	---
	7/8" - 14 ORB	HT4OF5	---
	3/4" - 14 NPTF	HT4F6	HT4F6-SS
	3/4" - 14 BSPP	HT4BF6	HT4BF6-SS
5/8"	1-1/6" - 12 ORB	HT4OF6	---
	7/8" - 14 ORB	HT5OF5	---
	3/4" - 14 NPTF	HT5F6	HT5F6-SS
	3/4" - 14 BSPP	HT5BF6	HT5BF6-SS
3/4"	1-1/16" - 12 ORB	HT5OF6	---
	7/8" - 14 ORB	HT6OF5	---
	3/4" - 14 NPTF	HT6F6	HT6F6-SS
	3/4" - 14 BSPP	HT6BF6	HT6BF6-SS
	1-1/16" - 12 ORB	HT6OF6	---
	1" - 11-1/2 NPTF	HT6F8	HT6F8-SS
	1" - 11 BSPP	HT6BF8	HT6BF8-SS
1"	1-5/16" - 12 ORB	HT6OF8	---
	1" - 11-1/2 NPTF	HT8F8	HT8F8-SS
	1" - 11 BSPP	HT8BF8	HT8BF8-SS
	1-5/16" - 12 ORB	HT8OF8	---
	1-1/4" - 11-1/2 NPTF	HT8F10	HT8F10-SS
1-1/2"	1-1/4" - 11 BSPP	HT8BF10	HT8BF10-SS
	1-5/8" - 12 ORB	HT8OF10	---
	1-1/2" - 11-1/2 NPTF	HT12F12	---
2"	1-1/2" - 11 BSPP	HT12BF12	---
	1-7/8" - 12 ORB	HT12OF12	---
	2" - 11-1/2 NPTF	HT16F16	---
2"	2" - 11 BSPP	HT16BF16	---
	2-1/2" - 12 ORB	HT16OF16	---



steel



316 stainless

**ISO16028 Flushface Male Threaded Plugs**

Body Size	Threads	Steel Part #
3/8"	3/8" - 18 NPTF	HT3M3
	1/2" - 14 NPTF	HT3M4
	9/16" - 18 ORB	HT3OM3
	3/4" - 16 ORB	HT3OM4
1/2"	1/2" - 14 NPTF	HT4M4



HT4M4



HT3OM4

### HT-Series Correct Connect®

#### ISO16028 Flushface Male Threaded Bulkhead Couplers

Body Size	Threads	Steel Part #
1/2"	13/16"-16 ORFS BH	4HTRB4
	7/8" - 14 JIC BH	4HTJB5
	1" - 14 ORFS BH	4HTRB5
	1-1/16" - 12 JIC BH	4HTJB6
	1-3/16"-12 ORFS BH	4HTRB6



4HTJB5



4HTRB5

#### ISO16028 Flushface Male Threaded Bulkhead Plugs

Body Size	Threads	Steel Part #
1/2"	13/16"-16 ORFS BH	HT4RB4
	7/8" - 14 JIC BH	HT4JB5
	1" - 14 ORFS BH	HT4RB5
	1-1/16" - 12 JIC BH	HT4JB6
	1-3/16"-12 ORFS BH	HT4RB6



HT4JB5



HT4RB5

#### ISO16028 Flushface 90° Female Threaded Couplers

Body Size	Threads	Steel Part #
1/2"	9/16"-18 ORB	4HT9OF3
	3/4" - 16 ORB	4HT9OF4



#### ISO16028 Flushface 90° Female Threaded Plugs

Body Size	Threads	Steel Part #
1/2"	9/16-18 ORB	HT49OF3
	3/4" - 16 ORB	HT49OF4



**K**

#### ISO16028 Flushface Interchange Coupler with Flange Sleeve

Body Size	Threads	Part #
1/4"	1/4" - 18 NPTF	2HTF2-FS
3/8"	3/8" - 18 NPTF	3HTF3-FS
1/2"	1/2" - 14 NPTF	4HTF4-FS
3/4"	3/4" - 14 NPTF	6HTF6-FS
1"	1" - 11-1/2 NPTF	8HTF8-FS



#### ISO16028 Flushface Coupler Dust Plugs

Body Size	Nitrile Part #
1/4"	2HTDP
3/8"	3HTDP
1/2"	4HTDP
5/8"	5HTDP
3/4"	6HTDP
1"	8HTDP



#### ISO16028 Flushface Plug Dust Caps

Body Size	Nitrile Part #
1/4"	HT2DC
3/8"	HT3DC
1/2"	HT4DC
5/8"	HT5DC
3/4"	HT6DC
1"	HT8DC



HT-Series Hydraulic Couplings

ISO16028 Flushface Interchange Coupler Seal Kits

Body Size	Coupler Style	Description	Nitrile Part #
1/4"	all	Stem/adapter/gland O-ring, gland B.U.	2HT-SKIT
3/8"	all	Stem/adapter/gland O-ring, gland B.U.	3HT-SKIT
1/2"	all	Stem/adapter/gland O-ring, gland B.U.	4HT-SKIT
5/8"	all	Stem/adapter/gland O-ring, gland B.U.	5HT-SKIT
3/4"	all	Stem/adapter/gland O-ring, gland B.U.	6HT-SKIT
1"	all	Stem/adapter/gland O-ring, gland B.U.	8HT-SKIT

ISO16028 Flushface Interchange Nipple Seal Kits

Body Size	Nipple Style	Description	Nitrile Part #
1/4"	all	Main valve seal and adapter O-ring	HT2-SKIT-V2
3/8"	all	Main valve seal and adapter O-ring	HT3-SKIT-V2
1/2"	all	Main valve seal and adapter O-ring	HT4-SKIT-V2
5/8"	all	Main valve seal and adapter O-ring	HT5-SKIT-V2
3/4"	all	Main valve seal and adapter O-ring	HT6-SKIT-V2
1"	all	Main valve seal and adapter O-ring	HT8-SKIT-V2

K

Industry/Competitor Interchange

Profiles

Parker FEM-Series, Snap-Tite 74-Series, Hansen FF, Aeroquip/  
Eaton FD89, Stucchi FIRG/Series 'A',  
Faster FFN/FFI/2FFN/2FFI, Safeway FF49-Series

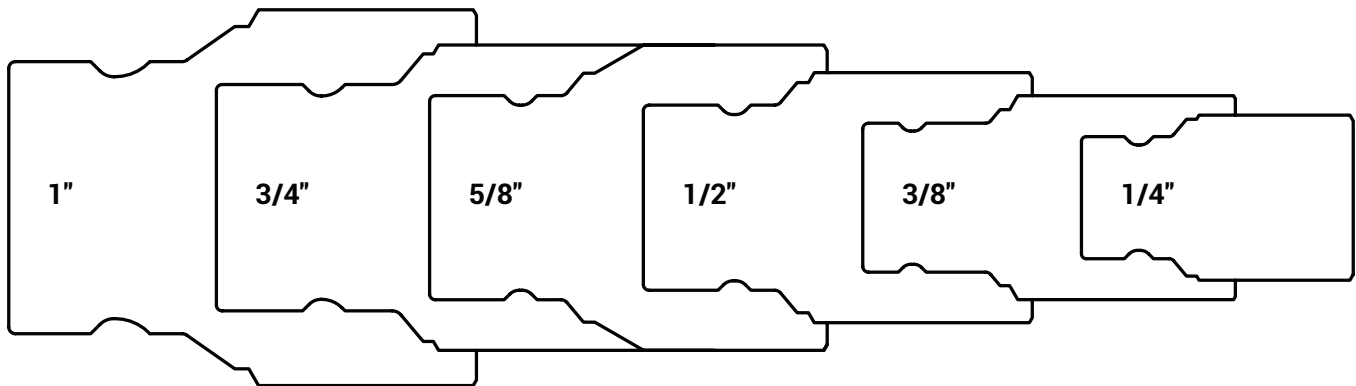

### HTE-Series Correct Connect®

#### Connect Under Pressure Flushface Female Threaded Plug

**Features**

- Head pressure or valve bleed-by has minimal effect on connection force
- Less susceptible to system contamination
- Design is scalable performing similarly in all sizes
- Smooth connection action
- Connectable with trapped pressure on HTE half only
- For use with HTZ- or HT-Series couplers

**Specifications**

- No maximum connection-pressure restrictions, up to **5,000 PSI**
- Pressure rating: **5,000 PSI at 70°F (21°C)**

**Approval**

- Conforms to ISO16028

Body Size	Threads	Steel Part #
3/8"	3/8"-18 NPTF	HTE3F3
	1/2"-14 NPTF	HTE3F4
	1/2"-14 BSPP	HTE3BF4
	3/4"-16 ORB	HTE3OF4
1/2"	1/2"-14 NPTF	HTE4F4
	1/2"-14 BSPP	HTE4BF4
	3/4"-16 ORB	HTE4OF4
	7/8"-14 ORB	HTE4OF5
	3/4"-14 NPTF	HTE4F6
	3/4"-14 BSPP	HTE4BF6
	1-1/16"-12 ORB	HTE4OF6
5/8"	7/8"-14 ORB	HTE5OF5
	3/4"-14 NPTF	HTE5F6
	3/4"-14 BSPP	HTE5BF6
	1-1/16"-12 ORB	HTE5OF6
3/4"	3/4"-14 NPTF	HTE6F6
	3/4"-14 BSPP	HTE6BF6
	1-1/16"-12 ORB	HTE6OF6
	1"-11-1/2 NPTF	HTE6F8
	1"-11 BSPP	HTE6BF8
	1-5/16"-12 ORB	HTE6OF8
1"	1"-11-1/2 NPTF	HTE8F8
	1"-11 BSPP	HTE8BF8
	1-5/16"-12 ORB	HTE8OF8
	1-1/4"-11-1/2 NPTF	HTE8F10
	1-1/4"-11 BSPP	HTE8BF10
	1-5/8"-12 ORB	HTE8OF10



### HTZ-Series Correct Connect®

#### Flushface Female Threaded Coupler

**Features**

- For use with HT- or HTE-Series plugs
- Connectable with trapped pressure on HTZ half only
- ISO16028 interchange

**Specifications**

- Connect under pressure up to **1,500 PSI** at 70°F (21°C)
- Pressure rating **5,000 PSI** at 70°F (21°C)



Body Size	Threads	Steel Part #
1/2"	1/2"-14 NPTF	4HTZF4
	3/4"-14 NPTF	4HTZF6
	3/4"-16 ORB	4HTZOF4
	7/8"-14 ORB	4HTZOF5
	1-1/16"-12 ORB	4HTZOF6

#### Flushface ISO16028 – AG ISO7241-A Adapter

**Features**

- Easily adapt machinery that uses AG style quick disconnects with flat face attachments or machinery that has flat face style quick disconnects with attachments that use the AG style
- Includes Correct Connect color banding system

**Specification**

- Maximum working pressure: **4,000 PSI** at 70°F (21°C)



4HTAG4



4AGHT4

Body Size	Description	Steel Part #
1/2"	ISO16028 flushface coupler x AG ISO7241-A plug	4HTAG4
	AG ISO7241-A coupler x ISO16028 flushface plug	4AGHT4

K



## XK-Series Hydraulic Couplings



### Features

- Automatic locking mechanism
- Machined components are manufactured using solid bar stock
- Stainless steel balls, retaining rings, and springs maximize corrosion resistance and extend service life
- Steel componentry is plated using ROHS-compliant zinc nickel for corrosion resistance
- Steel plugs are hardened to provide resistance to brinelling
- PTFE or TPC-ET anti-extrusion ring protects main coupling valve seal from dynamic impulse pressure damage

### Specifications

- 10K Flushface
- Interchanges with Parker FH-Series
- Plugs have molded polyurethane valve seals, with a temperature range of -65°F to 212°F (-54°C to 100°C)
- Couplers have a polyurethane valve stem O-ring, with a temperature range -65°F to 212°F (-54°C to 100°C)
- Ancillary coupler and plug seals are nitrile rubber, with a temperature range of -40°F to 250°F (-40°C to 121°C)

NOTE: contact Dixon for 1/4" body size

### Rated Pressure Chart

Body Size	XK-Series 10K Flushface							
	Max. Working		Connected Burst		Disconnected Burst Coupler		Disconnected Burst Plug	
	PSI	Bar	PSI	Bar	PSI	Bar	PSI	Bar
3/8"	10,000	690	30,000	2068	28,000	1930	27,000	1860

### Technical Specifications

Body Size	Interchange Standards				Functional Parameters			
	U.S. Military	U.S. Government	International Standards	ANSI/NFPA Standards	Air Inclusion	Fluid Loss	Vacuum inch HG	Flow ΔP = 15 PSI
3/8"	---	---	---	---	n/a	0.010cc	N/R	9.2 GPM

### XK-Series 10K Flushface Coupler (Female Threads)

Body Size	Part Detail			Length		Maximum O.D.		Hex Inch
	Part #	Threads	Material	inch	mm	inch	mm	
3/8"	3XKF3	3/8" - 18 NPTF	steel	2.41	61.21	1.31	33.27	1"



### XK-Series 10K Flushface Plug (Female Threads)

Body Size	Part Detail			Length		Maximum O.D.		Hex Inch
	Part #	Threads	Material	inch	mm	inch	mm	
3/8"	XK3F3	3/8" - 18 NPTF	steel	2.50	63.5	1.07	27.18	1"



### ST-Series Hydraulic Couplings

**Features**

- Interchangeable with Parker/Snap-Tite 71-Series
- Contact Dixon® for additional seal material options
- Contact Dixon for pressure ratings and other technical information
- Steel coupler sleeves are hardened to resist deformation and maximize service life
- Steel nipples are hardened to provide heavy duty performance

**Specification**

- Nitrile rubber seals standard, providing a temperature range of -40°F to 250°F (-40°C to 121°C)

**Heavy Duty Flushface Female Threaded Couplers**

Body Size	Threads	Steel Part #	316 Stainless Steel Part #
1/4"	1/4" - 18 NPTF	2STF2	2STF2-SS
	1/4" - 19 BSPP	2STBF2	2STBF2-SS
3/8"	1/4" - 18 NPTF	3STF2	---
	3/8" - 18 NPTF	3STF3	3STF3-SS
	3/8" - 19 BSPP	3STBF3	3STBF3-SS
	1/2" - 14 NPTF	3STF4	3STF4-SS
	1/2" - 14 BSPP	3STBF4	3STBF4-SS
1/2"	1/2" - 14 NPTF	4STF4	4STF4-SS
	1/2" - 14 BSPP	4STBF4	4STBF4-SS
	3/4" - 16 ORB	4STOF4	---
3/4"	3/4" - 14 NPTF	6STF6	6STF6-SS
	3/4" - 14 BSPP	6STBF6	6STBF6-SS
	1-1/16" - 12 ORB	6STOF6	---
1"	1" - 11-1/2 NPTF	8STF8	8STF8-SS
	1" - 11 BSPP	8STBF8	8STBF8-SS
	1-5/16" - 12 ORB	8STOF8	---
	1-1/4" - 11-1/2 NPTF	8STF10	8STF10-SS
	1-1/4" - 11 BSPP	8STBF10	8STBF10-SS
	1-5/8" - 12 ORB	8STOF10	---



steel



316 stainless

K

**Heavy Duty Flushface Old Style Female Threaded Couplers**

Body Size	Threads	Steel Part #	316 Stainless Steel Part #
1"	1" - 11-1/2 NPTF	8STF8-V2	---
	1" - 11 BSPP	8STBF8-V2	---
	1-1/4" - 11-1/2 NPTF	8STF10-V2	---
2"	1-1/2" - 11-1/2 NPTF	16STF12	---
	1-1/2" - 11 BSPP	16STBF12	---
	1-7/8" - 12 ORB	16STOF12	---
	2" - 11-1/2 NPTF	16STF16	16STF16-SS
	2" - 11 BSPP	16STBF16	---
	2-1/2" - 12 ORB	16STOF16	---



steel



316 stainless

## ST-Series Hydraulic Couplings

### Heavy Duty Flushface Female Threaded Plugs

Body Size	Threads	Steel Part #	316 Stainless Steel Part #
1/4"	1/4" - 18 NPTF	ST2F2	ST2F2-SS
	1/4" - 19 BSPP	ST2BF2	ST2BF2-SS
3/8"	1/4" - 18 NPTF	ST3F2	---
	3/8" - 18 NPTF	ST3F3	ST3F3-SS
	3/8" - 19 BSPP	ST3BF3	ST3BF3-SS
	1/2" - 14 NPTF	ST3F4	ST3F4-SS
	1/2" - 14 BSPP	ST3BF4	ST3BF4-SS
1/2"	1/2" - 14 NPTF	ST4F4	ST4F4-SS
	1/2" - 14 BSPP	ST4BF4	ST4BF4-SS
	3/4" - 16 ORB	ST4OF4	---
3/4"	3/4" - 14 NPTF	ST6F6	ST6F6-SS
	3/4" - 14 BSPP	ST6BF6	ST6BF6-SS
	1-1/16" - 12 ORB	ST6OF6	---
1"	1" - 11-1/2 NPTF	ST8F8	ST8F8-SS
	1" - 11 BSPP	ST8BF8	ST8BF8-SS
	1-5/16" - 12 ORB	ST8OF8	---
	1-1/4" - 11-1/2 NPTF	ST8F10	ST8F10-SS
	1-1/4" - 11 BSPP	ST8BF10	ST8BF10-SS
	1-5/8" - 12 ORB	ST8OF10	---



steel



316 stainless

### Heavy Duty Flushface Old Style Female Threaded Plugs

Body Size	Threads	Steel Part #	316 Stainless Steel Part #
1"	1" - 11-1/2 NPTF	ST8F8-V2	---
	1" - 11 BSPP	ST8BF8-V2	---
	1-1/4" - 11-1/2 NPTF	ST8F10-V2	---
2"	1-1/2" - 11-1/2 NPTF	ST16F12	---
	1-1/2" - 11 BSPP	ST16BF12	---
	1-7/8" - 12 ORB	ST16OF12	---
	2" - 11-1/2 NPTF	ST16F16	ST16F16-SS
	2" - 11 BSPP	ST16BF16	---
	2-1/2" - 12 ORB	ST16OF16	---



steel



316 stainless

### Plug Profiles

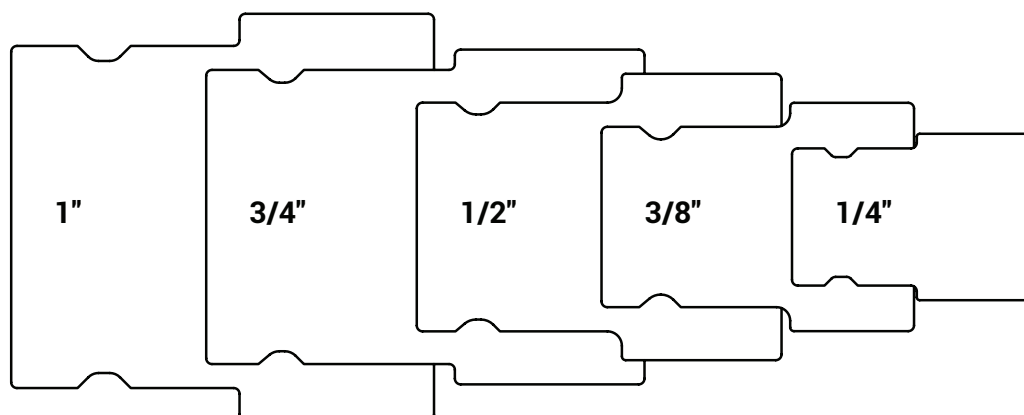

## ST-Series Hydraulic Couplings

### Dust Plugs



Body Size	Aluminum body with steel cable Part #
1/4"	2STDP-A
3/8"	3STDP-A
1/2"	4STDP-A
3/4"	6STDP-A
1"	8STDP-A
1"-V2	8STDP-A-V2
2"	16STDP-A

### Dust Caps



Body Size	Aluminum body with steel cable Part #
1/4"	ST2DC-A
3/8"	ST3DC-A
1/2"	ST4DC-A
3/4"	ST6DC-A
1"	ST8DC-A
1"-V2	ST8DC-A-V2
2"	ST16DC-A

### Heavy Duty Flushface Bulkhead Kits

K

Body Size	Mounting Hole I.D.	Seal Kit Contents	Steel Part #
1/4"	1.250"	two 360° retaining rings	2ST-BMK
3/8"	1.625"	two 360° retaining rings	3ST-BMK
1/2"	2.000"	two 360° retaining rings	4ST-BMK
3/4"	2.375"	two 360° retaining rings	6ST-BMK

### Heavy Duty Flushface Coupler Seal Kits

Body Size	Coupler Style	Seal Kit Contents	Nitrile Part #
1/4"	all	two seals and anti-extrusion rings	2ST-SKIT
3/8"	all	two seals and anti-extrusion rings	3ST-SKIT
1/2"	all	two seals and anti-extrusion rings	4ST-SKIT
3/4"	all	two seals and anti-extrusion rings	6ST-SKIT
1"	all	two seals and anti-extrusion rings	8ST-SKIT
1"	all	three seals and two anti-extrusion rings	8ST-SKIT-V2
2"	all	three seals and two anti-extrusion rings	16ST-SKIT

### Heavy Duty Flushface Plug Seal Kits

Body Size	Coupler Style	Seal Kit Contents	Nitrile Part #
1/4"	all	valve O-ring / back-up and adapter O-ring	ST2-SKIT
3/8"	all	valve O-ring / back-up and adapter O-ring	ST3-SKIT
1/2"	all	valve O-ring / back-up and adapter O-ring	ST4-SKIT
3/4"	all	valve O-ring / back-up and adapter O-ring	ST6-SKIT
1"	all	valve O-ring / back-up and adapter O-ring	ST8-SKIT
2"	all	main valve seal	ST16-SKIT

## PD-Series Diagnostic Interchange Couplings

### Features

- Interchangeable with ISO15171-1, Parker PD-Series, Aeroquip FD90, Tomco Series DK
- PTFE anti-extrusion ring protects main coupler O-ring from dynamic impulse pressure damage

### Specifications

- Nitrile rubber seal standard, providing a temperature range of -40°F to 250°F (-40°C to 121°C)
- Pressure rating **6000 PSI** at 70°F (21°C)

### Approval

- Steel componentry is plated using RoHS-compliant trivalent chrome

### Female NPT Couplers

Body Size	Threads	Steel Part #
1/8"	1/8" - 27 NPT	1PDF1
	1/4" - 18 NPT	1PDF2



### Male NPT Couplers

Body Size	Threads	Steel Part #
1/8"	1/4" - 18 NPT	1PDM2



### Female NPT Plugs

Body Size	Threads	Steel Part #
1/8"	1/8" - 27 NPT	PD1F1
	1/4" - 18 NPT	PD1F2

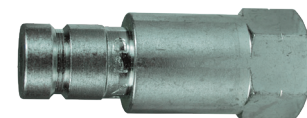

### Male Threaded Plugs

Body Size	Threads	Steel Part #
1/8"	1/8" - 27 NPT	PD1M1
	1/4" - 18 NPT	PD1M2
	7/16" - 20 ORB	PD1OM2
	9/16" - 18 ORB	PD1OM3



### Dust Caps

Body Size	Nitrile Part #
1/8"	H1DC



### Plug Profile

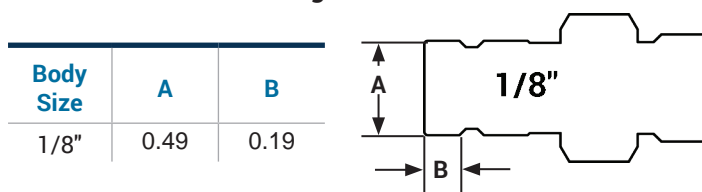

**VEP-Series Hydraulic Couplings**

**Features**

- No-spill, flush face valve minimizes air inclusion during connection and spillage during disconnection
- Thread-to-connect design and dual valve system in the plug allow for connecting under pressure
- Design eliminates premature wear or brinelling commonly found with locking ball designs when subjected to high impulse pressures
- Zinc nickel plating provides superior corrosion resistance
- Interchangeable with Parker FET, Stucchi VEP, DNP PST 4/FSI, Holmbury HFT
- Contact Dixon® for pressure ratings and other technical information

**Female Threaded Couplers**

Body Size	Threads	Steel Part #
1/4"	1/4" - 18 NPTF	2VEPF2
	1/4" - 19 BSPP	2VEPBF2
	9/16" - 18 ORB	2VEPOF3
3/8"	3/8" - 18 NPTF	3VEPF3
	3/8" - 19 BSPP	3VEPBF3
	3/4" - 16 ORB	3VEPOF4
	1/2" - 14 NPTF	3VEPF4
	1/2" - 14 BSPP	3VEPBF4
1/2"	1/2" - 14 NPTF	4VEPF4
	1/2" - 14 BSPP	4VEPBF4
	3/4" - 16 ORB	4VEPOF4
	7/8" - 14 ORB	4VEPOF5
	3/4" - 14 NPTF	4VEPF6
	3/4" - 14 BSPP	4VEPBF6
	1-1/16" - 12 ORB	4VEPOF6
3/4"	3/4" - 14 NPTF	6VEPF6
	3/4" - 14 BSPP	6VEPBF6
	1-1/16" - 12 ORB	6VEPOF6
1"	1" - 11-1/2 NPTF	8VEPF8
	1" - 11 BSPP	8VEPBF8
	1-5/16" - 12 ORB	8VEPOF8
1-1/4"	1-1/4" - 11-1/2 NPTF	10VEPF10
	1-1/4" - 11 BSPP	10VEPBF10
	1-5/8" - 12 ORB	10VEPOF10
1-1/2"	1-1/2" - 11-1/2 NPTF	12VEPF12
	1-1/2" - 11 BSPP	12VEPBF12
	1-7/8" - 12 ORB	12VEPOF12
2"	2" - 11-1/2 NPTF	16VEPF16
	2" - 11 BSPP	16VEPBF16
	2-1/2" - 12 ORB	16VEPOF16



**316 Stainless Steel VEP-Series**

Body Size	Threads	Style	316 Stainless Steel Part #
1"	1" - 11-1/2 NPTF	coupler	8VEPF8-SS
		plug	VEP8F8-SS

### VEP-Series Hydraulic Couplings Female Threaded Plugs

Body Size	Threads	Steel Part #
1/4"	1/4" - 18 NPTF	VEP2F2
	1/4" - 19 BSPP	VEP2BF2
	9/16" - 18 ORB	VEP2OF3
3/8"	3/8" - 18 NPTF	VEP3F3
	3/8" - 19 BSPP	VEP3BF3
	3/4" - 16 ORB	VEP3OF4
	1/2" - 14 NPTF	VEP3F4
	1/2" - 14 BSPP	VEP3BF4
1/2"	1/2" - 14 NPTF	VEP4F4
	1/2" - 14 BSPP	VEP4BF4
	3/4" - 16 ORB	VEP4OF4
	7/8" - 14 ORB	VEP4OF5
	3/4" - 14 NPTF	VEP4F6
	3/4" - 14 BSPP	VEP4BF6
	1-1/16" - 12 ORB	VEP4OF6
3/4"	3/4" - 14 NPTF	VEP6F6
	3/4" - 14 BSPP	VEP6BF6
	1-1/16" - 12 ORB	VEP6OF6
1"	1" - 11-1/2 NPTF	VEP8F8
	1" - 11 BSPP	VEP8BF8
	1-5/16" - 12 ORB	VEP8OF8
1-1/4"	1-1/4" - 11-1/2 NPTF	VEP10F10
	1-1/4" - 11 BSPP	VEP10BF10
	1-5/8" - 12 ORB	VEP10OF10
1-1/2"	1-1/2" - 11-1/2 NPTF	VEP12F12
	1-1/2" - 11 BSPP	VEP12BF12
	1-7/8" - 12 ORB	VEP12OF12
2"	2" - 11-1/2 NPTF	VEP16F16
	2" - 11 BSPP	VEP16BF16
	2-1/2" - 12 ORB	VEP16OF16



**K**

#### Dust Plugs

Body Size	Aluminum body with steel cable Part #
1/4"	2VEPDP-A
3/8"	3VEPDP-A
1/2"	4VEPDP-A
3/4"	6VEPDP-A
1"	8VEPDP-A
1-1/4"	10VEPDP-A
1-1/2"	12VEPDP-A
2"	16VEPDP-A



#### Dust Caps

Body Size	Aluminum body with steel cable Part #
1/4"	VEP2DC-A
3/8"	VEP3DC-A
1/2"	VEP4DC-A
3/4"	VEP6DC-A
1"	VEP8DC-A
1-1/4"	VEP10DC-A
1-1/2"	VEP12DC-A
2"	VEP16DC-A



**VEP-Series Hydraulic Couplings**

**Code 62 Flange Head Couplers**



flange head coupler

Body Size	Port Size	Steel Part #
3/4"	3/4"	6VEPFH6
1"	1"	8VEPFH8
1-1/4"	1-1/4"	10VEPFH10
1-1/2"	1-1/2"	12VEPFH12

**Code 62 Flange Head Plugs**



flange head plug

Body Size	Port Size	Steel Part #
3/4"	3/4"	VEP6FH6
1"	1"	VEP8FH8
1-1/4"	1-1/4"	VEP10FH10
1-1/2"	1-1/2"	VEP12FH12

**Code 62 Flange Pad Couplers**



flange pad coupler

Body Size	Port Size	Steel Part #
3/4"	3/4"	6VEFPF6
1"	1"	8VEFPF8
1-1/4"	1-1/4"	10VEFPF10
1-1/2"	1-1/2"	12VEFPF12

**Code 62 Flange Pad Plugs**



flange pad plug

Body Size	Port Size	Steel Part #
3/4"	3/4"	VEP6FP6
1"	1"	VEP8FP8
1-1/4"	1-1/4"	VEP10FP10
1-1/2"	1-1/2"	VEP12FP12

K



## VEP-BOP Series Hydraulic Couplings

### Features

- Red powder coated components and external O-rings for easy BOP service identification
- Blowout preventer (BOP) coupling contain FKM seals
- Interchangeable with VEP/VEP-HD Series, DNP FSI-BOP Series

### Material

- Steel components are plated using ROHS compliant zinc nickel

### Specification

- Pressure rating **5000 PSI at 70°F (21°C)**

### Approval

- BOP couplings have been fire tested and Lloyd's certified to **1300°F (700°C)** in accordance with API 16D. Certificate available upon request.

### Female Threaded Couplers

Body Size	Threads	Steel Part #
3/8"	3/8" - 18 NPTF	3VEPF3-BOP
1/2"	1/2" - 14 NPTF	4VEPF4-BOP
3/4"	3/4" - 14 NPTF	6VEPF6-BOP
1"	1" - 11-1/2 NPTF	8VEPF8-BOP
1-1/4"	1-1/4" - 11-1/2 NPTF	10VEPF10-BOP
1-1/2"	1-1/2" - 11-1/2 NPTF	12VEPF12-BOP



### Female Threaded Plugs

Body Size	Threads	Steel Part #
3/8"	3/8" - 18 NPTF	VEP3F3-BOP
1/2"	1/2" - 14 NPTF	VEP4F4-BOP
3/4"	3/4" - 14 NPTF	VEP6F6-BOP
1"	1" - 11-1/2 NPTF	VEP8F8-BOP
1-1/4"	1-1/4" - 11-1/2 NPTF	VEP10F10-BOP
1-1/2"	1-1/2" - 11-1/2 NPTF	VEP12F12-BOP



**K**

### W-Series Hydraulic Couplings

**Application**

- Designed for applications requiring a coupling that can be connected under residual pressure with minimum spillage and air inclusion
- Widely used on dump trailer wet-line hydraulic systems and oil field equipment
- Not recommended for continuous hydraulic impulse applications

**Features**

- Interchangeable with Aeroquip 5100 series, Parker 6100 series and Snap-Tite 78 series
- Contact Dixon® for pressure ratings and other technical information

**Specification**

- Nitrile rubber seals are standard, providing a temperature range of **-40°F to 250°F** (-40°C to 121°C)



brass



steel

#### Female Threaded Couplers

Body Size	Threads	Brass Part #	Steel Part #
1/4"	1/8" - 27 NPTF	2WF1-B	---
3/8"	1/4" - 18 NPTF	3WF2-B	---
	3/8" - 18 NPTF	3WF3-B	---
3/4"	1/2" - 14 NPTF	6WF4-B	---
	1/2" - 14 BSPP	6WBF4-B	---
	3/4" - 14 NPTF	6WF6-B	---
	3/4" - 14 BSPP	6WBF6-B	---
1"	1" - 11-1/2 NPTF	8WF8-B	8WF8
	1" - 11 BSPP	8WBF8-B	---
1-1/4"	1-1/4" - 11-1/2 NPTF	10WF10-B	---
	1-1/4" - 11 BSPP	10WBF10-B	---
1-1/2"	1-1/2" - 11-1/2 NPTF	12WF12-B	---
	1-1/2" - 11 BSPP	12WBF12-B	---

#### Hex-Nut Female Threaded Couplers

Body Size	Threads	Brass Part #	Steel Part #
1/4"	1/8" - 27 NPTF	2WF1-B-HN	---
3/8"	1/4" - 18 NPTF	3WF2-B-HN	---
	3/8" - 18 NPTF	3WF3-B-HN	---
3/4"	1/2" - 14 NPTF	6WF4-B-HN	---
	1/2" - 14 BSPP	6WBF4-B-HN	---
	3/4" - 14 NPTF	6WF6-B-HN	---
	3/4" - 14 BSPP	6WBF6-B-HN	---
1"	1" - 11-1/2 NPTF	8WF8-B-HN	8WF8-HN
	1" - 11 BSPP	8WBF8-B-HN	---
1-1/4"	1-1/4" - 11-1/2 NPTF	10WF10-B-HN	---
	1-1/4" - 11 BSPP	10WBF10-B-HN	---
1-1/2"	1-1/2" - 11-1/2 NPTF	12WF12-B-HN	---
	1-1/2" - 11 BSPP	12WBF12-B-HN	---



brass



steel

## W-Series Hydraulic Couplings

### Female Threaded Plugs

Body Size	Threads	Brass Part #	Steel Part #
1/4"	1/8" - 27 NPTF	W2F1-B	---
3/8"	1/4" - 18 NPTF	W3F2-B	---
	3/8" - 18 NPTF	W3F3-B	---
3/4"	1/2" - 14 NPTF	W6F4-B	---
	1/2" - 14 BSPP	W6BF4-B	---
	3/4" - 14 NPTF	W6F6-B	---
	3/4" - 14 BSPP	W6BF6-B	---
1"	1" - 11-1/2 NPTF	W8F8-B	W8F8
	1" - 11 BSPP	W8BF8-B	---
1-1/4"	1-1/4" - 11-1/2 NPTF	W10F10-B	---
	1-1/4" - 11 BSPP	W10BF10-B	---
1-1/2"	1-1/2" - 11-1/2 NPTF	W12F12-B	---
	1-1/2" - 11 BSPP	W12BF12-B	---



brass



steel

### Flanges

Body Size	Bolt Hole Size	Steel Part #
3/4"	0.201"	W6-BMF
1"	0.201"	W8-BMF
1-1/4"	0.201"	W10-BMF
1-1/2"	0.201"	W12-BMF



K

### Dust Plugs

Body Size	Steel body with steel cable Part #
1/4"	2WDP
3/8"	3WDP
3/4"	6WDP
1"	8WDP
1-1/4"	10WDP
1-1/2"	12WDP



### Dust Caps

Body Size	Steel body with steel cable Part #
1/4"	W2DC
3/8"	W3DC
3/4"	W6DC
1"	W8DC
1-1/4"	W10DC
1-1/2"	W12DC



## W-Series Hydraulic Couplings

### Coupler Repair Kits



Body Size	Coupler Style	Seal Kit Contents	Nitrile Part #
3/4"	all	bonded valve, O-rings, and PTFE backup	6W-RKIT-V2
1"	all	bonded valve, O-rings, and PTFE backup	8W-RKIT-V2
1-1/4"	all	bonded valve, O-rings, and PTFE backup	10W-RKIT-V2
1-1/2"	all	bonded valve, O-rings, and PTFE backup	12W-RKIT-V2

### Plug Repair Kits



Body Size	Coupler Style	Seal Kit Contents	Nitrile Part #
3/4"	all	valve assembly and O-ring	W6-RKIT-V2
1"	all	valve assembly and O-ring	W8-RKIT-V2
1-1/4"	all	valve assembly and O-ring	W10-RKIT-V2
1-1/2"	all	valve assembly and O-ring	W12-RKIT-V2

### Plug Profiles

**K**

#### Industry/Competitor Interchange

Aeroquip 5100  
Parker 6100

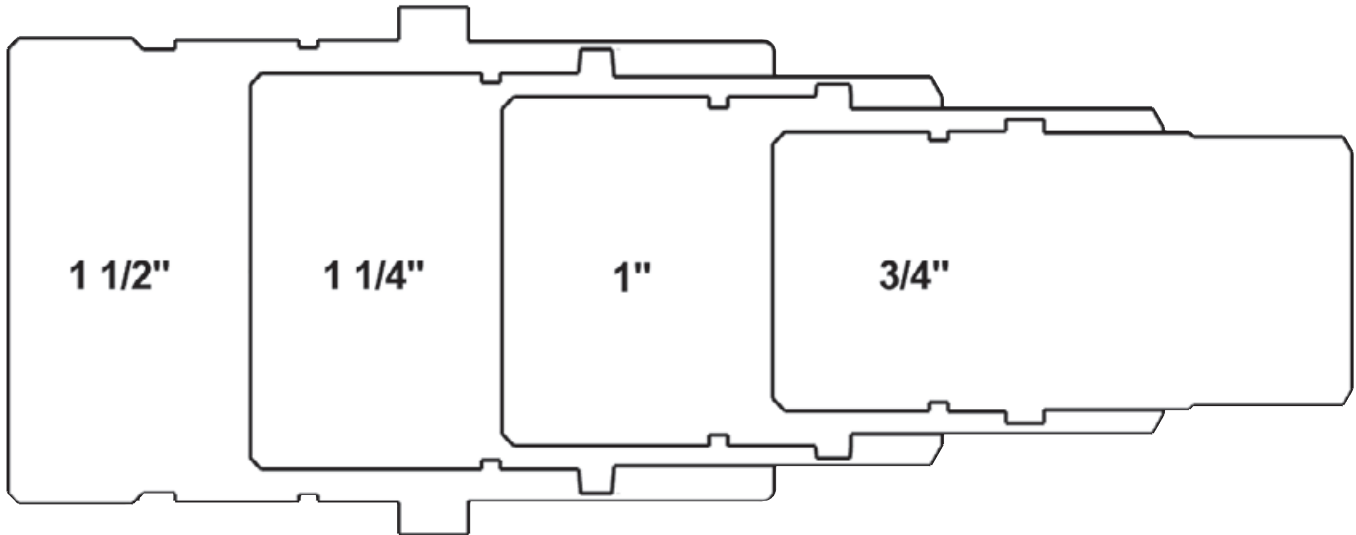

## WS-Series Hydraulic Couplings

### Application

- Used extensively in oil field and offshore oil rig applications

### Features

- Interchanges with Parker/Snap-Tite 75 series, Stucchi VOF, Faster OGV, Eaton FD85 and Holmbury LC
- Contact Dixon® for pressure ratings and other technical information

### Specification

- Nitrile rubber seals standard, providing a temperature range of -40°F to 250°F (-40°C to 121°C)

### Heavy-Duty Wingstyle Female Threaded Couplers

Body Size	Threads	Steel Part #	316 Stainless Steel Part #
3/4"	1/2" - 14 NPTF	6WSF4	---
	3/4" - 14 NPTF	6WSF6	6WSF6-SS
	3/4" - 14 BSPP	6WSBF6	6WSBF6-SS
	1-1/16" - 12 ORB	6WSOF6	---
1"	1" - 11-1/2 NPTF	8WSF8	8WSF8-SS
	1" - 11 BSPP	8WSBF8	8WSBF8-SS
	1-5/16" - 12 ORB	8WSOF8	---
1-1/4"	1-1/4" - 11-1/2 NPTF	10WSF10	10WSF10-SS
	1-1/4" - 11 BSPP	10WSBF10	10WSBF10-SS
	1-5/8" - 12 ORB	10WSOF10	---
1-1/2"	1-1/2" - 11-1/2 NPTF	12WSF12	12WSF12-SS
	1-1/2" - 11 BSPP	12WSBF12	12WSBF12-SS
	1-7/8" - 12 ORB	12WSOF12	---
	2" - 11-1/2 NPTF	16WSF16	16WSF16-SS
2"	2" - 11 BSPP	16WSBF16	16WSBF16-SS
	2-1/2" - 12 ORB	16WSOF16	---



steel

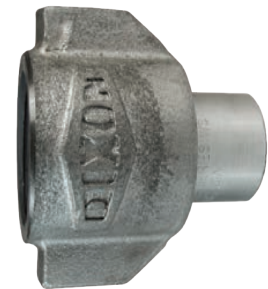

316 stainless

K

### Heavy-Duty Wingstyle Female Threaded Plugs

Body Size	Threads	Steel Part #	316 Stainless Steel Part #
3/4"	1/2" - 14 NPTF	WS6F4	---
	3/4" - 14 NPTF	WS6F6	WS6F6-SS
	3/4" - 14 BSPP	WS6BF6	WS6BF6-SS
	1-1/16" - 12 ORB	WS6OF6	---
1"	1" - 11-1/2 NPTF	WS8F8	WS8F8-SS
	1" - 11 BSPP	WS8BF8	WS8BF8-SS
	1-5/16" - 12 ORB	WS8OF8	---
1-1/4"	1-1/4" - 11-1/2 NPTF	WS10F10	WS10F10-SS
	1-1/4" - 11 BSPP	WS10BF10	WS10BF10-SS
	1-5/8" - 12 ORB	WS10OF10	---
1-1/2"	1-1/2" - 11-1/2 NPTF	WS12F12	WS12F12-SS
	1-1/2" - 11 BSPP	WS12BF12	WS12BF12-SS
	1-7/8" - 12 ORB	WS12OF12	---
2"	2" - 11-1/2 NPTF	WS16F16	WS16F16-SS
	2" - 11 BSPP	WS16BF16	WS16BF16-SS
	2-1/2" - 12 ORB	WS16OF16	---

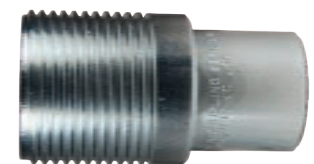

steel



316 stainless

**WS-Series Hydraulic Couplings**

**Heavy-Duty Wingstyle Code 62 Flange Head Couplers**

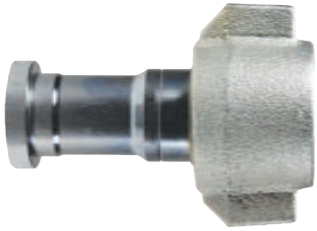

Body Size	Port Size	Steel Part #
3/4"	3/4"	6WSFH6
1"	1"	8WSFH8
1-1/4"	1-1/4"	10WSFH10
1-1/2"	1-1/2"	12WSFH12
2"	2"	16WSFH16

**Heavy-Duty Wingstyle Code 62 Flange Head Plugs**



Body Size	Port Size	Steel Part #
3/4"	3/4"	WS6FH6
1"	1"	WS8FH8
1-1/4"	1-1/4"	WS10FH10
1-1/2"	1-1/2"	WS12FH12
2"	2"	WS16FH16

**Heavy-Duty Wingstyle Code 62 Flange Pad Couplers**

**K**

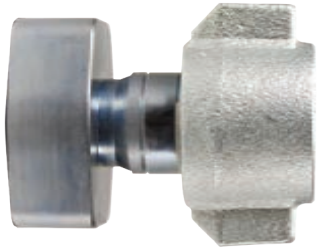

Body Size	Port Size	Steel Part #
3/4"	3/4"	6WSFP6
1"	1"	8WSFP8
1-1/4"	1-1/4"	10WSFP10
1-1/2"	1-1/2"	12WSFP12
2"	2"	16WSFP16

**Heavy-Duty Wingstyle Code 62 Flange Pad Plugs**

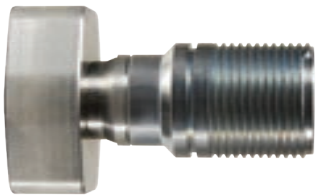

Body Size	Port Size	Steel Part #
3/4"	3/4"	WS6FP6
1"	1"	WS8FP8
1-1/4"	1-1/4"	WS10FP10
1-1/2"	1-1/2"	WS12FP12
2"	2"	WS16FP16

## WS-Series Hydraulic Couplings

### Heavy-Duty Wingstyle Rigid Dust Plugs

Body Size	Aluminum body with steel cable Part #
3/4"	6WSDP-A
1"	8WSDP-A
1-1/4"	10WSDP-A
1-1/2"	12WSDP-A
2"	16WSDP-A



### Heavy-Duty Wingstyle Rigid Dust Caps

Body Size	Aluminum body with steel cable Part #
3/4"	WS6DC-A
1"	WS8DC-A
1-1/4"	WS10DC-A
1-1/2"	WS12DC-A
2"	WS16DC-A



### Heavy-Duty Wingstyle Coupler Seal Kits

Body Size	Coupler Style	Seal Kit Contents	Nitrile Part #
3/4"	all	body / valve seals and retaining rings	6WS-SKIT
1"	all	body / valve seals and retaining rings	8WS-SKIT
1-1/4"	all	body / valve seals and retaining rings	10WS-SKIT
1-1/2"	all	body / valve seals and retaining rings	12WS-SKIT
2"	all	body / valve seals and retaining rings	16WS-SKIT



**K**

### Heavy-Duty Wingstyle Coupler Repair Kits

Body Size	Coupler Style	Repair Kit Contents	Nitrile Part #
3/4"	all	valve assembly, O-ring, and PTFE B.U.	6WS-RKIT
1"	all	valve assembly, O-ring, and PTFE B.U.	8WS-RKIT
1-1/4"	all	valve assembly, O-ring, and PTFE B.U.	10WS-RKIT
1-1/2"	all	valve assembly, O-ring, and PTFE B.U.	12WS-RKIT
2"	all	valve assembly, O-ring, and PTFE B.U.	16WS-RKIT



## WS-BOP Series Hydraulic Couplings

### Application

- Designed for use in oil rig BOP systems where couplings are required to operate under fire conditions in an emergency

### Features

- Contact Dixon® for pressure ratings and other technical information
- Sleeve is cast using a process that provides better surface finishes, tighter tolerance control, and excellent repeatability
- Blowout preventer couplings are individually marked with the BOP series designation

### Approval

- Fire tested and Lloyd's certified to 1300°F (700°C) in accordance with API 16D (Certificate #NAO 0601041/1)

### Heavy-Duty Wingstyle Female Threaded Couplers

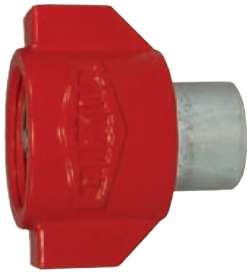

Body Size	Threads	Steel Part #	316 Stainless Steel Part #
3/4"	1/2" - 14 NPTF	6WSF4-BOP	---
	3/4" - 14 NPTF	6WSF6-BOP	6WSF6-SS-BOP
1"	1" - 11-1/2 NPTF	8WSF8-BOP	8WSF8-SS-BOP
1-1/4"	1-1/4" - 11-1/2 NPTF	10WSF10-BOP	10WSF10-SS-BOP
1-1/2"	1-1/2" - 11-1/2 NPTF	12WSF12-BOP	12WSF12-SS-BOP
2"	2" - 11-1/2 NPTF	16WSF16-BOP	16WSF16-SS-BOP

### Heavy-Duty Wingstyle Female Threaded Plugs

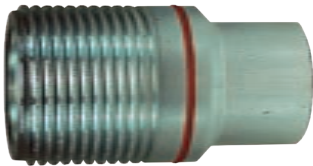

Body Size	Threads	Steel Part #	316 Stainless Steel Part #
3/4"	1/2" - 14 NPTF	WS6F4-BOP	---
	3/4" - 14 NPTF	WS6F6-BOP	WS6F6-SS-BOP
1"	1" - 11-1/2 NPTF	WS8F8-BOP	WS8F8-SS-BOP
1-1/4"	1-1/4" - 11-1/2 NPTF	WS10F10-BOP	WS10F10-SS-BOP
1-1/2"	1-1/2" - 11-1/2 NPTF	WS12F12-BOP	WS12F12-SS-BOP
2"	2" - 11-1/2 NPTF	WS16F16-BOP	WS16F16-SS-BOP

### Heavy-Duty Wingstyle Seal Kits



Body Size	Coupler Style	Repair Kit Contents	FR FKM Part #
3/4"	all	body / valve seals and retaining rings	6BOP-SKIT
1"	all	body / valve seals and retaining rings	8BOP-SKIT
1-1/4"	all	body / valve seals and retaining rings	10BOP-SKIT
1-1/2"	all	body / valve seals and retaining rings	12BOP-SKIT
2"	all	body / valve seals and retaining rings	16BOP-SKIT

K



## T-Series Hydraulic Couplings

### Application

- Designed for high pressure applications including hydraulic rams and pumps where low flow and pressures up to **10,000 PSI** are encountered

### Features

- Interchangeable with Parker 3000 and Enerpac C 604
- Both poppet valve and ball valve styles available

### Specification

- Nitrile O-ring with TPC-ET back up ring standard providing a temperature range of **-40°F to 250°F (-40°C to 121°C)**

### Female NPTF Ball Coupler

Body Size	Threads	Steel Part #
1/4"	1/4" - 18 NPTF	2TF2
3/8"	3/8" - 18 NPTF	3TF3



### Male NPTF Ball Couplers

Body Size	Threads	Steel Part #	Threads	316 Stainless Steel Part #
1/4"	1/4" - 18 NPTF	2TM2	---	---
3/8"	3/8" - 18 NPTF	3TM3	3/8" - 18 NPT	3TM3-SS



**K**

### Male NPTF Poppet Couplers

Body Size	Threads	Steel Part #	316 Stainless Steel Part #
3/8"	3/8" - 18 NPT	3TM3-PV	3TM3-SS-PV



### Female NPTF Ball Plugs

Body Size	Threads	Steel Part #	Threads	316 Stainless Steel Part #
1/4"	1/4" - 18 NPTF	T2F2	---	---
3/8"	3/8" - 18 NPTF	T3F3	3/8" - 18 NPT	T3F3-SS



### Female NPTF Poppet Plugs

Body Size	Threads	Steel Part #	316 Stainless Steel Part #
3/8"	3/8" - 18 NPT	T3F3-PV	T3F3-SS-PV



**T-Series Hydraulic Couplings**



**Dust Plugs**

Body Size	Steel body with rubber lanyard Part #
1/4"	2TDP
3/8"	3TDP



**Dust Caps**

Body Size	Steel body with steel cable Part #
1/4"	T2DC
3/8"	T3DC



**Ball Coupler Seal Kits**

Body Size	Coupler Style	Seal Kit Contents	Urethane Part #
1/4"	ball valve	body seal	2T-SKIT
3/8"	ball valve	body seal	3T-SKIT



**Industry/Competitor Interchange**

Parker 3000  
Enerpac C604

**Plug Profiles**

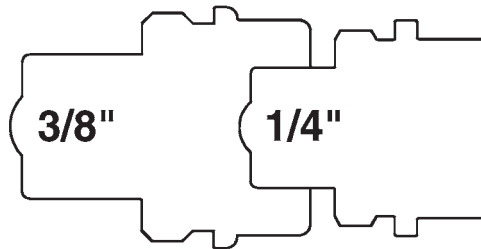

## CVV-Series Hydraulic Couplings

### Features

- Contact Dixon® for pressure ratings and other technical information.
- Interchangeable with European Screw-Together, Inteva STG-Series, Faster CVV-Series, DNP PVV3, Voswinkel Type-HS

### Specification

- Nitrile rubber seal standard, providing a temperature range of -13°F to 257°F (-25°C to 125°C)

### European Female Threaded Couplers

Body Size	Threads	Steel Part #
1/4"	1/4" - 18 NPTF	2CVVF2
	1/4" - 19 BSPP	2CVVBF2
	M14X1.5	2CVVFM1415
3/8"	3/8" - 18 NPTF	3CVVF3
	3/8" - 19 BSPP	3CVVBF3
	M16X1.5	3CVVFM1615
1/2"	1/2" - 14 NPTF	4CVVF4
	3/4" - 16 ORB	4CVVOF4
	1/2" - 14 BSPP	4CVVBF4
	M18X1.5	4CVVFM1815
	7/8" - 14 ORB	4CVVOF5
3/4"	M22X1.5	4CVVFM2215
	3/4" - 14 NPTF	6CVVF6
	3/4" - 14 BSPP	6CVVBF6
1"	M22X1.5	6CVVFM2215
	1" - 11-1/2 NPTF	8CVVF8
	1" - 11 BSPP	8CVVBF8
1-1/4"	1-1/4" - 11-1/2 NPTF	10CVVF10
	1-1/4" - 11 BSPP	10CVVBF10



K

### European Female Threaded Plugs

Body Size	Threads	Steel Part #
1/4"	1/4" - 18 NPTF	CVV2F2
	1/4" - 19 BSPP	CVV2BF2
	M14X1.5	CVV2FM1415
3/8"	3/8" - 18 NPTF	CVV3F3
	3/8" - 19 BSPP	CVV3BF3
	M16X1.5	CVV3FM1615
1/2"	1/2" - 14 NPTF	CVV4F4
	3/4" - 16 ORB	CVV4OF4
	1/2" - 14 BSPP	CVV4BF4
	M18X1.5	CVV4FM1815
	7/8" - 14 ORB	CVV4OF5
3/4"	M22X1.5	CVV4FM2215
	3/4" - 14 NPTF	CVV6F6
	3/4" - 14 BSPP	CVV6BF6
1"	M22X1.5	CVV6FM2215
	1" - 11-1/2 NPTF	CVV8F8
	1" - 11 BSPP	CVV8BF8
1-1/4"	1-1/4" - 11-1/2 NPTF	CVV10F10
	1-1/4" - 11 BSPP	CVV10BF10



### CVV-Series Hydraulic Couplings

#### European Dust Plugs



Body Size	Plastic Part #
1/4"	2CVVDP
3/8"	3CVVDP
1/2"	4CVVDP
3/4"	6CVVDP
1"	8CVVDP
1-1/4"	10CVVDP

#### European Dust Caps



Body Size	Plastic Part #
1/4"	CVV2DC
3/8"	CVV3DC
1/2"	CVV4DC
3/4"	CVV6DC
1"	CVV8DC
1-1/4"	CVV10DC

### TD-Series: 15K and 20K Pressure Couplings



4TDF4-SS



TD4F4-SS



4TDPF4.5-SS



TD4PF4.5-SS

#### Application

- Commonly used on water-blast or wireline equipment and pump systems

#### Materials

- Machined components are manufactured using 316 stainless steel bar stock
- Stainless steel retaining ring maximizes corrosion resistance and extends service life
- Couplers have a nitrile anti-extrusion ring, providing resistance to O-ring dynamic impulse pressure damage
- Nitrile rubber seals are standard

#### Sizes

- 1/2" body
- 1/2" FNPT or 9/16" MP threads

#### Features

- Unvalved, high flow
- Thread to connect
- Dust caps and plugs available

#### Specifications

- Temperature range: -40°F to 250°F (-40°C to 121°C)
- **15,000 PSI** for NPTF threads; **20,000 PSI** for MP threads
- Interchangeable with SPIR STAR CQD Series, DNP CRS Series, and Jetstream Screw Type

Body Size	Threads	Description	Stainless Steel Part #
1/2"	1/2" - 14 NPTF	coupler	4TDF4-SS
		plug	TD4F4-SS
	9/16" MP	coupler	4TDPF4.5-SS
		plug	TD4PF4.5-SS

#### Dust Caps

Body Size	Threads	Aluminum Part #
1/2"	1/2" - 14 NPTF	TD4DC-A
	9/16" MP	TD4.5DC-A

#### Dust Plugs

Body Size	Threads	Aluminum Part #
1/2"	1/2" - 14 NPTF	4TDDP-A
	9/16" MP	4.5TDDP-A



K

## E-Series Hydraulic Couplings

### Features

- Couplers have no internal valves, which provide maximum flow with minimum pressure drop
- Contact Dixon® for additional seal material options
- Contact Dixon for pressure ratings and other technical information
- Interchanges with Parker ST, Hannifin SST/BST, Foster FST, Hansen ST, and Tomco ST couplings
- Do not disconnect with pressure in line 

### Specification

- Nitrile rubber seals are standard, providing a temperature range of **-40°F to 250°F** (-40°C to 121°C)

### Straight-Through Female Threaded Couplers

Body Size	Threads	Brass Part #	303 Stainless Steel Part #
1/8"	1/8" - 27 NPTF	1EF1-B	1EF1-S
1/4"	1/4" - 18 NPTF	2EF2-B	2EF2-S
	1/4" - 19 BSPP	2EBF2-B	---
3/8"	3/8" - 18 NPTF	3EF3-B	3EF3-S
	3/8" - 19 BSPP	3EBF3-B	---
1/2"	1/2" - 14 NPTF	4EF4-B	4EF4-S
	1/2" - 14 BSPP	4EBF4-B	---
3/4"	3/4" - 14 NPTF	6EF6-B	6EF6-S
	3/4" - 14 BSPP	6EBF6-B	---
1"	1" - 11-1/2 NPTF	8EF8-B	8EF8-S
	1" - 11 BSPP	8EBF8-B	---
1-1/4"	1-1/4" - 11-1/2 NPTF	10EF10-B	10EF10-S
1-1/2"	1-1/2" - 11-1/2 NPTF	12EF12-B	12EF12-S
2"	2" - 11-1/2 NPTF	16EF16-B	16EF16-S



brass

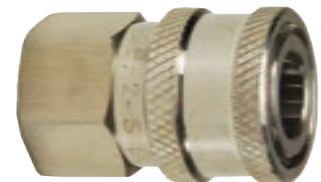

303 stainless



brass



303 stainless

### Straight-Through Male Threaded Couplers

Body Size	Threads	Brass Part #	303 Stainless Steel Part #
1/8"	1/8" - 27 NPTF	1EM1-B	1EM1-S
1/4"	1/4" - 18 NPTF	2EM2-B	2EM2-S
3/8"	3/8" - 18 NPTF	3EM3-B	3EM3-S
1/2"	1/2" - 14 NPTF	4EM4-B	4EM4-S
3/4"	3/4" - 14 NPTF	6EM6-B	6EM6-S
1"	1" - 11-1/2 NPTF	8EM8-B	8EM8-S
1-1/4"	1-1/4" - 11-1/2 NPTF	10EM10-B	---
1-1/2"	1-1/2" - 11-1/2 NPTF	12EM12-B	---
2"	2" - 11-1/2 NPTF	16EM16-B	---



### Straight-Through Hose Barb Couplers

Body Size	Hose I.D.	Brass Part #
1/4"	1/4"	2ES2-B
3/8"	3/8"	3ES3-B
1/2"	1/2"	4ES4-B
3/4"	3/4"	6ES6-B
1"	1"	8ES8-B

### E-Series Hydraulic Couplings

#### Straight-Through Female Threaded Plugs

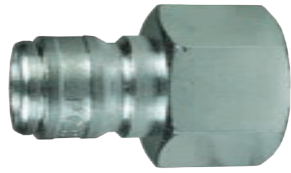

steel



brass

Body Size	Threads	Steel Part #	Brass Part #
1/8"	1/8" - 27 NPTF	E1F1	E1F1-B
1/4"	1/4" - 18 NPTF	E2F2	E2F2-B
	1/4" - 19 BSPP	---	E2BF2-B
3/8"	3/8" - 18 NPTF	E3F3	E3F3-B
	3/8" - 19 BSPP	---	E3BF3-B
1/2"	1/2" - 14 NPTF	E4F4	E4F4-B
	1/2" - 14 BSPP	---	E4BF4-B
3/4"	3/4" - 14 NPTF	E6F6	E6F6-B
	3/4" - 14 BSPP	---	E6BF6-B
1"	1" - 11-1/2 NPTF	E8F8	E8F8-B
	1" - 11 BSPP	---	E8BF8-B
1-1/4"	1-1/4" - 11-1/2 NPTF	E10F10	E10F10-B
1-1/2"	1-1/2" - 11-1/2 NPTF	E12F12	E12F12-B
2"	2" - 11-1/2 NPTF	E16F16	E16F16-B

Body Size	Threads	303 Stainless Steel Part #
1/8"	1/8" - 27 NPTF	E1F1-S
1/4"	1/4" - 18 NPTF	E2F2-S
3/8"	3/8" - 18 NPTF	E3F3-S
1/2"	1/2" - 14 NPTF	E4F4-S
3/4"	3/4" - 14 NPTF	E6F6-S
1"	1" - 11-1/2 NPTF	E8F8-S
1-1/4"	1-1/4" - 11-1/2 NPTF	E10F10-S
1-1/2"	1-1/2" - 11-1/2 NPTF	E12F12-S
2"	2" - 11-1/2 NPTF	E16F16-S

#### Straight-Through Male Threaded Plugs



steel



brass

Body Size	Threads	Steel Part #	Brass Part #
1/8"	1/8" - 27 NPTF	E1M1	E1M1-B
1/4"	1/4" - 18 NPTF	E2M2	E2M2-B
3/8"	3/8" - 18 NPTF	E3M3	E3M3-B
1/2"	1/2" - 14 NPTF	E4M4	E4M4-B
3/4"	3/4" - 14 NPTF	E6M6	E6M6-B
1"	1" - 11-1/2 NPTF	E8M8	E8M8-B
1-1/4"	1-1/4" - 11-1/4 NPTF	E10M10	E10M10-B
1-1/2"	1-1/2" - 11-1/2 NPTF	E12M12	E12M12-B
2"	2" - 11-1/2 NPTF	E16M16	E16M16-B

Body Size	Threads	303 Stainless Steel Part #
1/8"	1/8" - 27 NPTF	E1M1-S
1/4"	1/4" - 18 NPTF	E2M2-S
3/8"	3/8" - 18 NPTF	E3M3-S
1/2"	1/2" - 14 NPTF	E4M4-S
3/4"	3/4" - 14 NPTF	E6M6-S
1"	1" - 11-1/2 NPTF	E8M8-S

## E-Series Hydraulic Couplings

### Straight-Through Hose Barb Plugs

Body Size	Hose I.D.	Steel Part #	Brass Part #
1/4"	1/4"	E2S2	E2S2-B
3/8"	3/8"	E3S3	E3S3-B
1/2"	1/2"	E4S4	E4S4-B
3/4"	3/4"	E6S6	E6S6-B
1"	1"	E8S8	E8S8-B



steel



brass

### Straight-Through Coupler Seal Kits

Body Size	Coupler Style	Seal Kit Contents	Nitrile Part #	FKM Part #	EPDM Part #
1/4"	all	body O-ring	2E-SKIT	F-2E-SKIT	P-2E-SKIT
3/8"	all	body O-ring	3E-SKIT	F-3E-SKIT	P-3E-SKIT
1/2"	all	body O-ring	4E-SKIT	F-4E-SKIT	P-4E-SKIT
3/4"	all	body O-ring	6E-SKIT	F-6E-SKIT	P-6E-SKIT
1"	all	body O-ring	8E-SKIT	F-8E-SKIT	P-8E-SKIT
1-1/4"	all	body O-ring	10E-SKIT	F-10E-SKIT	P-10E-SKIT
1-1/2"	all	body O-ring	12E-SKIT	F-12E-SKIT	P-12E-SKIT
2"	all	body O-ring	16E-SKIT	F-16E-SKIT	P-16E-SKIT

### Plug Profiles

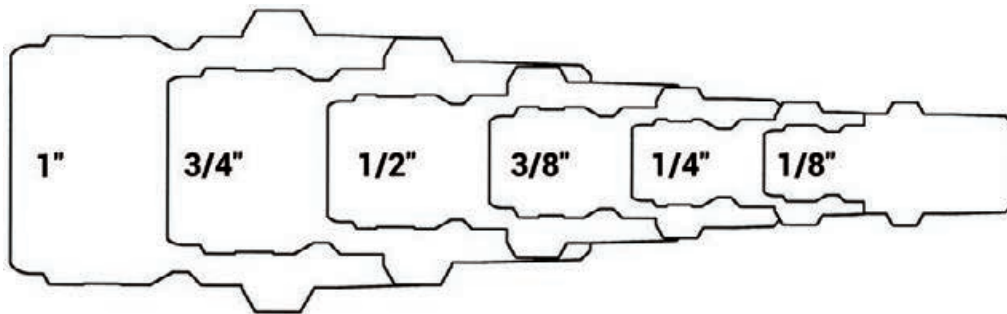

### Industry/Competitor Interchange

Foster FST  
Parker ST  
Hansen ST



### EA-Series Hydraulic Couplings

**Features**

- Plug mounted sleeve guard protects against accidental disconnection
- Smooth bore full-flow design ensures maximum flow with minimal pressure drop
- Steel body components maximize service life by resisting the effects of brinelling and internal erosion
- Heavy duty knurled sleeve with locking pin provides maximum protection against brinelling and accidental disconnection
- Interchangeable with Parker WB, Aeroquip FD69, and Snap Tite 56

**Specifications**

- Nitrile rubber seals are standard, providing a temperature range of **-40°F to 250°F** (-40°C to 121°C)
- Pressure rating **10000 PSI** at 70°F (21°C)

**Water-Blast Couplers**



Body Size	Female Threads	Steel Part #
1/2"	3/8" - 18 NPTF	4EAF3
	1/2" - 14 NPTF	4EAF4

**Water-Blast Plugs**



Body Size	Female Threads	Steel Part #
1/2"	3/8" - 18 NPTF	EA4F3
	1/2" - 14 NPTF	EA4F4

**Water-Blast Seal Kits**

Body Size	Coupler Style	Seal Kit Contents	Nitrile Part #
1/2"	all	body O-ring and PTFE back-up	4EA-SKIT

Body Size	Coupler Style	Seal Kit Contents	FKM Part #
1/2"	all	body O-ring and PTFE back-up	F-4EA-SKIT

Body Size	Coupler Style	Seal Kit Contents	EPDM Part #
1/2"	all	body O-ring and PTFE back-up	P-4EA-SKIT

**Plug Profile**

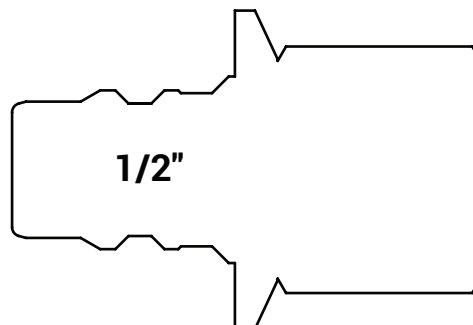

K



## CM-Series Hydraulic Couplings

### Features

- Interchangeable with Foster Series- FJT, Hansen Flo-Temp, Tomco MC-Series, Parker Moldmate, DME Jiffy-Tite
- Contact Dixon® for pressure ratings and other technical information

### Specification

- Silicone gaskets and valve O-rings standard providing a temperature range -90°F to 400°F (-68°C to 205°C)

### Industrial Mold Plug Female NPTF

Body Size	Threads	Steel Part #	Brass Part #
1/4"	1/8" - 27 NPTF	CM2F1	CM2F1-B
	1/4" - 18 NPTF	CM2F2	CM2F2-B
	3/8" - 18 NPTF	CM2F3	CM2F3-B
3/8"	1/4" - 18 NPTF	CM3F2	CM3F2-B
	3/8" - 18 NPTF	CM3F3	CM3F3-B
1/2"	1/2" - 14 NPTF	---	CM4F4-B
	3/4" - 14 NPTF	---	CM4F6-B



steel



brass

### Industrial Mold Plug Male NPTF

Body Size	Threads	Brass Part #
1/4"	1/8" - 27 NPTF	CM2M1-B
	1/4" - 18 NPTF	CM2M2-B
	3/8" - 18 NPTF	CM2M3-B
3/8"	1/4" - 18 NPTF	CM3M2-B
	3/8" - 18 NPTF	CM3M3-B
	1/2" - 14 NPTF	CM3M4-B
1/2"	1/2" - 14 NPTF	CM4M4-B
	3/4" - 14 NPTF	CM4M6-B



K

### Industrial Mold Extension Plug Male NPTF

Body Size	Threads	Brass Part #
1/4"	1/8" - 27 NPTF	CM2M1-B-L2.5
		CM2M1-B-L4
		CM2M1-B-L5.5
	1/4" - 18 NPTF	CM2M2-B-L2.5
		CM2M2-B-L4
		CM2M2-B-L5.5
		CM2M2-B-L7
3/8"	1/8" - 27 NPTF	CM3M1-B-L2.5
		CM3M1-B-L4
		CM3M1-B-L5.5
	1/4" - 18 NPTF	CM3M1-B-L7
		CM3M2-B-L2.5
		CM3M2-B-L4
		CM3M2-B-L5.5
		CM3M2-B-L7
		CM3M2-B-L8.5
		CM3M2-B-L11.5



**CM-Series Hydraulic Couplings**

**Industrial Mold Unvalved Coupler Female NPTF**



Body Size	Threads	Brass Part #
1/4"	1/8" - 27 NPTF	2CMF1-B-E
	1/4" - 18 NPTF	2CMF2-B-E
3/8"	1/4" - 18 NPTF	3CMF2-B-E
	3/8" - 18 NPTF	3CMF3-B-E
1/2"	1/2" - 14 NPTF	4CMF4-B-E

**Industrial Mold Valved Coupler Female NPTF**



Body Size	Threads	Brass Part #
1/4"	1/8" - 27 NPTF	2CMF1-B
3/8"	1/4" - 18 NPTF	3CMF2-B

**Industrial Mold Unvalved Coupler Hose Barb**



Body Size	Hose I.D.	Brass Part #
1/4"	1/4"	2CMS2-B-E
	5/16"	2CMS2.5-B-E
	3/8"	2CMS3-B-E
3/8"	3/8"	3CMS3-B-E
	1/2"	3CMS4-B-E
1/2"	1/2"	4CMS4-B-E
	3/4"	4CMS6-B-E

**Industrial Mold Valved Coupler Hose Barb**



Body Size	Hose I.D.	Brass Part #
1/4"	1/4"	2CMS2-B
	5/16"	2CMS2.5-B
	3/8"	2CMS3-B
3/8"	3/8"	3CMS3-B
	1/2"	3CMS4-B

**Industrial Mold Unvalved Coupler Push-Loc Barb**



Body Size	Hose I.D.	Brass Part #
1/4"	1/4"	2CMB2-B-E
	3/8"	2CMB3-B-E
3/8"	3/8"	3CMB3-B-E
	1/2"	3CMB4-B-E
1/2"	1/2"	4CMB4-B-E
	3/4"	4CMB6-B-E

**Industrial Mold Valved Coupler Push-Loc Barb**



Body Size	Hose I.D.	Brass Part #
1/4"	1/4"	2CMB2-B
	3/8"	2CMB3-B
3/8"	3/8"	3CMB3-B
	1/2"	3CMB4-B

K

### CM-Series Hydraulic Couplings

#### Industrial Mold Unvalved Coupler 45° Hose Barb

Body Size	Hose I.D.	Brass Part #
1/4"	1/4"	2CM4S2-B-E
	5/16"	2CM4S2.5-B-E
	3/8"	2CM4S3-B-E
3/8"	3/8"	3CM4S3-B-E
	1/2"	3CM4S4-B-E
1/2"	1/2"	4CM4S4-B-E
	3/4"	4CM4S6-B-E

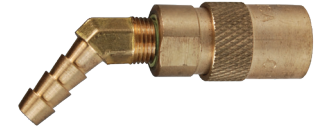

#### Industrial Mold Valved Coupler 45° Hose Barb

Body Size	Hose I.D.	Brass Part #
1/4"	1/4"	2CM4S2-B
	1/4"	2CM4S2.5-B
	3/8"	2CM4S3-B
3/8"	3/8"	3CM4S3-B
	1/2"	3CM4S4-B

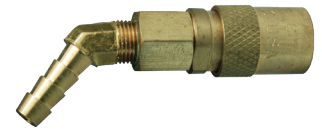

#### Industrial Mold Unvalved Coupler 45° Push-Loc Barb

Body Size	Hose I.D.	Brass Part #
1/4"	1/4"	2CM4B2-B-E
	3/8"	2CM4B3-B-E
3/8"	3/8"	3CM4B3-B-E
	1/2"	3CM4B4-B-E
1/2"	1/2"	4CM4B4-B-E
	3/4"	4CM4B6-B-E

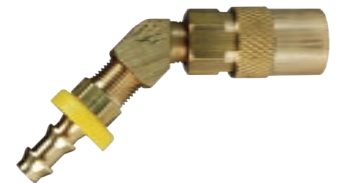

K

#### Industrial Mold Valved Coupler 45° Push-Loc Barb

Body Size	Hose I.D.	Brass Part #
1/4"	1/4"	2CM4B2-B
	3/8"	2CM4B3-B
3/8"	3/8"	3CM4B3-B
	1/2"	3CM4B4-B



#### Plug Profiles

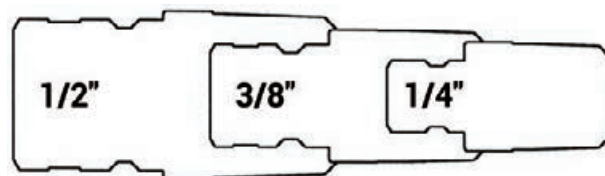

**CM-Series Hydraulic Couplings**

**Industrial Mold Unvalved Coupler 90° Hose Barb**

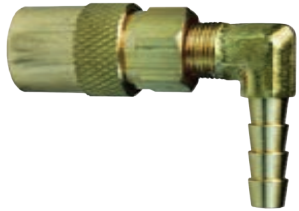

Body Size	Hose I.D.	Brass Part #
1/4"	1/4"	2CM9S2-B-E
	5/16"	2CM9S2.5-B-E
	3/8"	2CM9S3-B-E
3/8"	3/8"	3CM9S3-B-E
	1/2"	3CM9S4-B-E
1/2"	1/2"	4CM9S4-B-E
	3/4"	4CM9S6-B-E

**Industrial Mold Valved Coupler 90° Hose Barb**



Body Size	Hose I.D.	Brass Part #
1/4"	1/4"	2CM9S2-B
	5/16"	2CM9S2.5-B
	3/8"	2CM9S3-B
3/8"	3/8"	3CM9S3-B
	1/2"	3CM9S4-B

**Industrial Mold Unvalved Coupler 90° Push-Loc Barb**

K

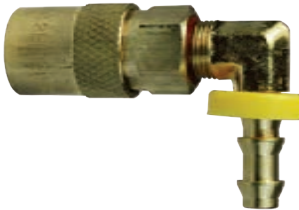

Body Size	Hose I.D.	Brass Part #
1/4"	1/4"	2CM9B2-B-E
	3/8"	2CM9B3-B-E
3/8"	3/8"	3CM9B3-B-E
	1/2"	3CM9B4-B-E
1/2"	1/2"	4CM9B4-B-E
	3/4"	4CM9B6-B-E

**Industrial Mold Valved Coupler 90° Push-Loc Barb**

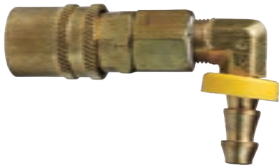

Body Size	Hose I.D.	Brass Part #
1/4"	1/4"	2CM9B2-B
	3/8"	2CM9B3-B
3/8"	3/8"	3CM9B3-B
	1/2"	3CM9B4-B

**Industrial Mold Interchange Dust Plugs**



Body Size	Lanyard	Brass Part #
1/4"	N/A	2CMPC-B
3/8"	N/A	3CMPC-B
1/2"	N/A	4CMPC-B

**Industrial Mold Coupler Seal Kits**



Body Size	Coupler Style	Seal Kit Contents	Silicone Part #
1/4"	all	body seal	2CM-SKIT
3/8"	all	body seal	3CM-SKIT
1/2"	all	body seal	4CM-SKIT

## Hydraulic Adapters - Flat Face

### Male Unions

**Specifications**

- Reference SAE 520101
- Pressure rating at 70°F (21°C)

Male Flat Face	PSI	Zinc Plated Steel Part #
9/16"-18	6000	FS2403-4
11/16"-16	6000	FS2403-6
13/16"-16	6000	FS2403-8
1"-14	6000	FS2403-10
1-3/16"-12	6000	FS2403-12
1-7/16"-12	6000	FS2403-16



### Male x Male SAE O-ring Boss® Connectors

**Specifications**

- Reference SAE 520120
- Pressure rating at 70°F (21°C)

Male Flat Face	Male SAE O-ring Boss	PSI	Zinc Plated Steel Part #
9/16"-18	7/16"-20	5000	FS6400-4-4
11/16"-16	9/16"-18	5000	FS6400-6-6
13/16"-16	3/4"-16	4500	FS6400-8-8
1"-14	7/8"-14	3500	FS6400-10-10
1-3/16"-12	1-1/16"-12	3500	FS6400-12-12
1-7/16"-12	1-5/16"-12	3000	FS6400-16-16



### Male x Male NPTF Connectors

**Specifications**

- Reference SAE 520102
- Pressure rating at 70°F (21°C)

Male Flat Face	Male NPTF	PSI	Zinc Plated Steel Part #
9/16"-18	1/4"-18	5000	FS2404-4-4
11/16"-16	3/8"-18	4000	FS2404-6-6
13/16"-16	1/2"-14	3000	FS2404-8-8
1-3/16"-12	3/4"-14	2500	FS2404-12-12
1-7/16"-12	1"-11-1/2	2000	FS2404-16-16



### Male x Female Swivel Nut 90° Elbows

**Specifications**

- Reference SAE 520221
- Pressure rating at 70°F (21°C)

Male Flat Face	Female Flat Face	PSI	Zinc Plated Steel Part #
9/16"-18	9/16"-18	6000	FS6500-4-4
11/16"-16	11/16"-16	6000	FS6500-6-6
13/16"-16	13/16"-16	6000	FS6500-8-8
1"-14	1"-14	6000	FS6500-10-10
1-3/16"-12	1-3/16"-12	6000	FS6500-12-12
1-7/16"-12	1-7/16"-12	6000	FS6500-16-16



### Male x Male SAE O-ring Boss 90° Elbows

**Specifications**

- Reference SAE 520220
- Pressure rating at 70°F (21°C)

Male Flat Face	Male SAE O-ring Boss	PSI	Zinc Plated Steel Part #
9/16"-18	7/16"-20	5000	FS6801-4-4
11/16"-16	9/16"-18	5000	FS6801-6-6
13/16"-16	3/4"-16	4500	FS6801-8-8
1"-14	7/8"-14	3500	FS6801-10-10
1-3/16"-12	1-1/16"-12	3500	FS6801-12-12
1-7/16"-12	1-5/16"-12	3000	FS6801-16-16



## Hydraulic Adapters - Flat Face

### Male x Male NPTF 90° Elbows



#### Specifications

- Reference SAE 520202
- Pressure rating at 70°F (21°C)

Male Flat Face	Male NPTF	PSI	Zinc Plated Steel Part #
9/16"-18	1/4"-18	5000	FS2501-4-4
11/16"-16	3/8"-18	4000	FS2501-6-6
13/16"-16	1/2"-14	3000	FS2501-8-8
1-3/16"-12	3/4"-14	2500	FS2501-12-12
1-7/16"-12	1"-11-1/2	2000	FS2501-16-16

### Male Union Tees

#### Specifications

- Reference SAE 520401
- Pressure rating at 70°F (21°C)



Male Flat Face	Male Flat Face	Male Flat Face	PSI	Zinc Plated Steel Part #
9/16"-18	9/16"-18	9/16"-18	6000	FS2603-4
11/16"-16	11/16"-16	11/16"-16	6000	FS2603-6
13/16"-16	13/16"-16	13/16"-16	6000	FS2603-8
1"-14	1"-14	1"-14	6000	FS2603-10
1-3/6"-12	1-3/16"-12	1-3/16"-12	6000	FS2603-12
1-7/16"-12	1-7/16"-12	1-7/16"-12	6000	FS2603-16

### Male x Female Swivel x Male Run Tees

#### Specifications

- Reference SAE 520432
- Pressure rating at 70°F (21°C)



Male Flat Face	Female Flat Face Swivel	Male Flat Face	PSI	Zinc Plated Steel Part #
9/16"-18	9/16"-18	9/16"-18	4500	FS6602-4
11/16"-16	11/16"-16	11/16"-16	4000	FS6602-6
13/16"-16	13/16"-16	13/16"-16	4000	FS6602-8
1"-14	1"-14	1"-14	3000	FS6602-10
1-3/16"-12	1-3/16"-12	1-3/16"-12	3000	FS6602-12
1-7/16"-12	1-7/16"-12	1-7/16"-12	2500	FS6602-16

### Caps

#### Specifications

- Reference SAE 520112
- Pressure rating at 70°F (21°C)



Female Flat Face	PSI	Zinc Plated Steel Part #
9/16"-18	6000	FS304C-4
11/16"-16	6000	FS304C-6
13/16"-16	6000	FS304C-8
1"-14	6000	FS304C-10
1-3/16"-12	6000	FS304C-12
1-7/16"-12	6000	FS304C-16

### Plugs

#### Specifications

- Reference SAE 520109
- Pressure rating at 70°F (21°C)



Male Flat Face	PSI	Zinc Plated Steel Part #
9/16"-18	6000	FS2408-4
11/16"-16	6000	FS2408-6
13/16"-16	6000	FS2408-8
1"-14	6000	FS2408-10
1-3/16"-12	6000	FS2408-12
1-7/16"-12	6000	FS2408-16

K

### Hydraulic Adapters - O-ring Boss®

#### Port Reducers

**Specification**

- Pressure rating at 70°F (21°C)

Male SAE O-ring Boss	Female O-ring Port	PSI	Zinc Plated Steel Part #
9/16"-18	7/16"-20	5000	6410-6-4
	3/4"-16	4500	6410-6-8
3/4"-16	7/8"-14	3500	6410-8-10
	9/16"-18	4500	6410-8-6
7/8"-14	1-1/16"-12	3500	6410-10-12
	3/4"-16	3500	6410-10-8
1-1/16"-12	7/8"-14	3000	6410-12-10
	1-5/16"-12	3000	6410-12-16



#### Adjustable Unions

**Specification**

- Pressure rating at 70°F (21°C)

Male O-ring Boss	Adjustable O-ring Boss	PSI	Zinc Plated Steel Part #
7/16"-20	7/16"-20	4500	6403-4
9/16"-18	9/16"-18	4000	6403-6
3/4"-16	3/4"-16	4000	6403-8
7/8"-14	7/8"-14	3000	6403-10
1-1/16"-12	1-1/16"-12	3000	6403-12
1-5/16"-12	1-5/16"-12	2500	6403-16

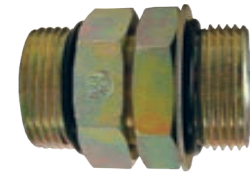

#### Male JIC x Male SAE

**Specifications**

- Reference SAE 070120
- Pressure rating at 70°F (21°C)

Male JIC	Male SAE O-ring Boss	PSI	Zinc Plated Steel Part #
7/16"-20	7/16"-20	5000	1231-04-04
	9/16"-18	5000	1231-04-06
	3/4"-16	4500	1231-04-08
1/2"-20	1/2"-20	5000	1231-05-05
	7/16"-20	5000	1231-06-04
9/16"-18	9/16"-18	5000	1231-06-06
	3/4"-16	4500	1231-06-08
	7/8"-14	3500	1231-06-10
3/4"-16	9/16"-18	4500	1231-08-06
	3/4"-16	4500	1231-08-08
	7/8"-14	3500	1231-08-10
	1-1/16"-12	3500	1231-08-12
7/8"-14	3/4"-16	3500	1231-10-08
	7/8"-14	3500	1231-10-10
	1-1/16"-12	3500	1231-10-12
1-1/16"-12	7/8"-14	3500	1231-12-10
	1-1/16"-12	3500	1231-12-12
	1-5/16"-12	3000	1231-12-16
1-5/16"-12	1-1/16"-12	3000	1231-16-12
	1-5/16"-12	3000	1231-16-16
	1-5/8"-12	2500	1231-16-20
1-6/8"-12	1-5/16"-12	2500	1231-20-16
1-5/8"-12	1-5/8"-12	2500	1231-20-20



K

#### Male x Male NPTF

**Feature**

- Pressure rating at 70°F (21°C)

Male SAE O-ring Boss	Male NPTF Pipe Adapter	PSI	Zinc Plated Steel Part #
7/16"-20	1/4"-18	5000	6401-4-4
	1/4"-18	4000	6401-6-4
9/16"-18	3/8"-18	4000	6401-6-6
	1/2"-14	3000	6401-6-8
3/4"-16	3/8"-18	3000	6401-8-6
	1/2"-14	3000	6401-8-8
7/8"-14	1/2"-14	3000	6401-10-8
1-1/16"-12	3/4"-14	2500	6401-12-12
1-5/16"-12	1"-11-1/2	2000	6401-16-16



### Hydraulic Adapters - O-ring Boss® (ORB)

Male x Female NPTF

**Specification**

- Pressure rating at 70°F (21°C)



Male SAE O-ring Boss	Female NPTF Pipe	PSI	Zinc Plated Steel Part #
7/16"-20	1/8"-27	5000	6405-4-2
	1/4"-18	5000	6405-4-4
	3/8"-18	4000	6405-4-6
9/16"-18	1/4"-18	4000	6405-6-4
	3/8"-18	4000	6405-6-6
	1/2"-14	3000	6405-6-8
3/4"-16	3/8"-18	4000	6405-8-6
	1/2"-14	3000	6405-8-8
7/8"-14	1/4"-18	3000	6405-10-4
	1/2"-14	3000	6405-10-8
	3/4"-14	2500	6405-10-12
1-1/16"-12	1/2"-14	3000	6405-12-8
	3/4"-14	2500	6405-12-12
	1"-11-1/2	2000	6405-12-16
1-5/16"-12	3/4"-14	2500	6405-16-12
	1"-11-1/2	2000	6405-16-16
	1-1/4"-11-1/2	1150	6405-16-20
1-5/8"-12	1"-11-1/2	2000	6405-20-16
	1-1/4"-11-1/2	1150	6405-20-20

### 90° Male SAE x Male JIC Elbows

**Specifications**

- Reference SAE 070220
- Pressure rating at 70°F (21°C)

K



Male SAE O-ring Boss	Male JIC	PSI	Zinc Plated Steel Part #
7/16"-20	7/16"-20	5000	1238-04-04
	9/16"-18	5000	1238-04-06
9/16"-18	7/16"-20	5000	1238-06-04
	9/16"-18	5000	1238-06-06
3/4"-16	9/16"-18	4500	1238-08-06
	3/4"-16	4500	1238-08-08
	7/8"-14	3500	1238-08-10
7/8"-14	3/4"-16	3500	1238-10-08
	7/8"-14	3500	1238-10-10
	1-1/16"-12	3500	1238-10-12
1-1/16"-12	7/8"-14	3500	1238-12-10
	1-1/16"-12	3500	1238-12-12
1-5/16"-16	1-5/16"-12	3000	1238-12-16
	1-1/16"-12	3000	1238-16-12
1-5/16"-12	1-5/16"-12	3000	1238-16-16
	1-5/16"-12	2500	1238-20-16
1-5/8"-12	1-5/8"-12	2500	1238-20-20
	1-7/8"-12	2000	1238-24-24

### 90° SAE x Female NPSM Swivel Nut Elbows

**Specifications**

- Reference SAE 140257
- Pressure rating at 70°F (21°C)



Male SAE O-ring Boss	Female NPSM Swivel	PSI	Zinc Plated Steel Part #
7/16"-20	1/4"-18	4500	6901-4-4
	3/8"-18	4000	6901-4-6
9/16"-18	1/4"-18	4000	6901-6-4
	3/8"-18	4000	6901-6-6
	1/2"-14	4000	6901-6-8
3/4"-16	3/8"-18	3500	6901-8-6
	1/2"-14	4000	6901-8-8
	3/4"-14	3000	6901-8-12
7/8"-14	1/2"-14	3500	6901-10-8
	3/4"-14	3000	6901-10-12
	1/2"-14	3500	6901-12-8
1-1/16"-12	3/4"-14	3000	6901-12-12
	1"-11-1/2	2500	6901-12-16
	3/4"-14	3000	6901-16-12
1-5/16"-12	1"-11-1/2	2500	6901-16-16
	1-1/4"-11-1/2	2000	6901-16-20
1-5/8"-12	1-1/4"-11-1/2	2000	6901-20-20



### Hydraulic Adapters - O-ring Boss® (ORB)

#### 45° Male SAE x Male JIC Elbows

**Specifications**

- Reference SAE 070320
- Pressure rating at 70°F (21°C)

Male SAE O-ring Boss	Male JIC	PSI	Zinc Plated Steel Part #
7/16"-20	7/16"-20	5000	1240-04-04
9/16"-18	9/16"-18	5000	1240-06-06
	3/4"-16	4500	1240-06-08
3/4"-16	9/16"-18	4500	1240-08-06
	3/4"-16	4500	1240-08-08
	7/8"-14	3500	1240-08-10
7/8"-14	3/4"-16	3500	1240-10-08
	7/8"-14	3500	1240-10-10
	1-1/16"-12	3500	1240-10-12
1-1/16"-12	7/8"-14	3500	1240-12-10
	1-1/16"-12	3500	1240-12-12
1-5/16"-12	1-5/16"-12	3000	1240-12-16
	1-5/16"-12	3000	1240-16-16
1-5/8"-12	1-5/16"-12	2500	1240-20-16
	1-5/8"-12	2500	1240-20-20



#### Male 37° Flare x Male Branch Tees

**Specifications**

- Reference SAE 070429
- Pressure rating at 70°F (21°C)

(2) Male JIC 37°	Male SAE O-ring Boss	PSI	Zinc Plated Steel Part #
7/16"-20	7/16"-20	5000	6803-4
9/16"-18	9/16"-18	5000	6803-6
3/4"-16	3/4"-16	4500	6803-8
7/8"-14	7/8"-14	3500	6803-10
1-1/16"-12	1-1/16"-12	3500	6803-12
1-5/16"-12	1-5/16"-12	3000	6803-16



**K**

#### SAE Plugs

**Specifications**

- Reference SAE 090109A
- Pressure rating at 70°F (21°C)

Male SAE O-ring Boss	PSI	Zinc Plated Steel Part #
7/16"-20	5000	1255-04H
9/16"-18	5000	1255-06H
3/4"-16	4500	1255-08H
7/8"-14	3500	1255-10H
1-1/16"-12	3500	1255-12H
1-5/16"-12	3000	1255-16H
1-5/8"-12	2500	1255-20H
1-7/8"-12	2000	1255-24H
2-1/2"-12	1500	1255-32H



#### Hollow Hex Plugs

**Specifications**

- Reference SAE 090109B
- Requires Allen wrench
- Pressure rating at 70°F (21°C)

Male SAE O-ring Boss	PSI	Zinc Plated Steel Part #
7/16"-20	5000	6408HHP-4
9/16"-18	5000	6408HHP-6
3/4"-16	4500	6408HHP-8
7/8"-14	3500	6408HHP-10
1-1/16"-12	3500	6408HHP-12
1-5/16"-12	3000	6408HHP-16
1-5/8"-12	2500	6408HHP-20
1-7/8"-12	1500	6408HHP-24
2-2/1"-12	1500	6408HHP-32

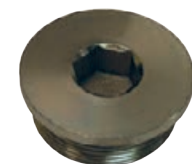

### Hydraulic Adapters - 37° JIC

Male x Male

**Specifications**

- Reference SAE 070101
- Pressure rating at 70°F (21°C)



Male JIC 37°	Male JIC 37°	PSI	Zinc Plated Steel Part #
7/16"-20	7/16"-20	5000	1204-04-04
9/16"-18	9/16"-18	5000	1204-06-06
3/4"-16	7/16"-20	4500	1204-08-04
	3/4"-16	4500	1204-08-08
7/8"-14	3/4"-16	3500	1204-10-08
	7/8"-14	3500	1204-10-10
1-1/16"-12	3/4"-16	3500	1204-12-08
	7/8"-14	3500	1204-12-10
	1-1/16"-12	3500	1204-12-12
1-5/16"-12	1-1/16"-12	3000	1204-16-12
	1-5/16"-12	3000	1204-16-16
1-5/8"-12	1-5/8"-12	2500	1204-20-20
1-7/8"-12	1-7/8"-12	2000	1204-24-24

Male Flare x Male NPTF

**Specifications**

- Reference SAE 070102
- Pressure rating at 70°F (21°C)

K



Male JIC 37° Flare	Male NPTF	PSI	Zinc Plated Steel Part #	316 Stainless Steel Part #
7/16"-20	1/8"-27	4500	2404-4-2	---
	1/4"-18	4500	2404-4-4	SS2404-4-4
	3/8"-18	4000	2404-4-6	---
	1/2"-14	3000	2404-4-8	---
1/2"-20	1/8"-27	4000	2404-5-2	---
	1/8"-27	4000	2404-6-2	---
9/16"-18	1/4"-18	4000	2404-6-4	---
	3/8"-18	4000	2404-6-6	SS2404-6-6
	1/2"-14	3000	2404-6-8	---
	1/4"-18	4000	2404-8-4	---
3/4"-16	3/8"-18	4000	2404-8-6	---
	1/2"-14	3000	2404-8-8	SS2404-8-8
	3/4"-14	2500	2404-8-12	---
7/8"-14	1/2"-14	3000	2404-10-8	---
	3/4"-14	2500	2404-10-12	---
1-1/16"-12	1/2"-14	3000	2404-12-8	---
	3/4"-14	2500	2404-12-12	SS2404-12-12
	1"-11-1/2	2000	2404-12-16	---
1-5/16"-12	3/4"-14	2500	2404-16-12	---
	1"-11-1/2	2000	2404-16-16	SS2404-16-16
1-5/8"-12	1-1/4"-11-1/2	1150	2404-20-20	---
1-7/8"-12	1-1/2"-11-1/2	1000	2404-24-24	---
2-1/2"-12	2"-11-1/2	1000	2404-32-32	---

Male Flare x Female NPTF

**Specifications**

- Reference SAE 070103
- Pressure rating at 70°F (21°C)



Male JIC 37° Flare	Female NPTF	PSI	Zinc Plated Steel Part #	316 Stainless Steel Part #
7/16"-20	1/8"-27	4500	2405-4-2	---
	1/4"-18	4500	2405-4-4	SS2405-4-4
9/16"-18	1/4"-18	4000	2405-6-4	---
	3/8"-18	4000	2405-6-6	SS2405-6-6
	1/2"-14	3000	2405-6-8	---
3/4"-16	3/8"-18	4000	2405-8-6	---
	1/2"-14	3000	2405-8-8	SS2405-8-8
	3/4"-14	2500	2405-8-12	---
7/8"-14	1/2"-14	3000	2405-10-8	---
	3/4"-14	2500	2405-12-12	SS2405-12-12
1-1/16"-12	1"-11-1/2	2000	2405-12-16	---
	1"-11-1/2	2000	2405-16-16	SS2405-16-16
1-5/8"-12	1-1/4"-11-1/2	1150	2405-20-20	---

### Hydraulic Adapters - 37° JIC

#### Female Swivel x Male NPTF

**Specification**

- Pressure rating at 70°F (21°C)

Female JIC 37° Swivel	Male NPTF Pipe	PSI	Zinc Plated Steel Part #
7/16"-20	1/8"-27	4500	6505-4-2
	1/4"-18	4500	6505-4-4
1/2"-20	1/4"-18	4000	6505-5-4
	1/4"-18	4000	6505-6-4
9/16"-18	3/8"-18	4000	6505-6-6
	3/8"-18	4000	6505-8-6
3/4"-16	1/2"-14	3000	6505-8-8
	1/2"-14	3000	6505-10-8
7/8"-14	3/4"-14	2500	6505-10-12
	1/2"-14	3000	6505-12-8
1-1/16"-12	3/4"-14	2500	6505-12-12
	3/4"-14	2500	6505-16-12
1-5/16"-12	1"-1/2	2000	6505-16-16
	1-1/4"-11-1/2	1150	6505-20-20
1-7/8"-12	1-1/2"-11-1/2	1000	6505-24-24
2-1/2"-12	2"-11-1/2	1000	6505-32-32



#### Female Swivel x Female NPTF

**Specification**

- Pressure rating at 70°F (21°C)

Female JIC 37° Swivel	Female NPTF	PSI	Zinc Plated Steel Part #
7/16"-20	1/4"-18	4500	6506-4-4
	3/8"-18	4000	6506-4-6
9/16"-18	1/4"-18	4000	6506-6-4
	3/8"-18	4000	6506-6-6
3/4"-16	1/2"-14	3000	6506-8-8
	1/2"-14	3000	6506-10-8
1-1/16"-12	3/4"-14	2500	6506-12-12
1-5/16"-12	1"-11-1/2	2000	6506-16-16



**K**

#### 90° Male Flare Elbows

**Specifications**

- Reference SAE 070201
- Pressure rating at 70°F (21°C)

Male JIC 37° Flare	Male JIC 37° Flare	PSI	Zinc Plated Steel Part #
7/16"-20	7/16"-20	5000	1234-04-04
9/16"-18	9/16"-18	5000	1234-06-06
3/4"-16	3/4"-16	4500	1234-08-08
7/8"-14	7/8"-14	3500	1234-10-10
1-1/16"-12	1-1/16"-12	3500	1234-12-12
1-5/16"-12	1-5/16"-12	3000	1234-16-16
1-5/8"-12	1-5/8"-12	2500	1234-20-20



#### 90° Male Flare x Female Flare Swivel Elbows

**Specifications**

- Reference SAE 070221
- Pressure rating at 70°F (21°C)

Male 37° JIC Flare	Female 37° JIC Swivel	PSI	Zinc Plated Steel Part #
7/16"-20	7/16"-20	5000	6500-4
	9/16"-18	5000	6500-6
9/16"-18	7/16"-20	5000	6500-6-4
	3/4"-16	4500	6500-6-8
3/4"-16	3/4"-16	4500	6500-8
	9/16"-18	4500	6500-8-6
7/8"-14	7/8"-14	3500	6500-8-10
	7/8"-14	3500	6500-10
1-1/16"-12	1-1/16"-12	3500	6500-12
	7/8"-14	3500	6500-12-10
1-5/16"-12	1-5/16"-12	3000	6500-16
1-5/8"-12	1-5/8"-12	2500	6500-20



### Hydraulic Adapters - 37° JIC

#### 90° Male Flare x Male NPTF Elbows

**Specifications**

- Reference SAE 070202
- Pressure rating at 70°F (21°C)

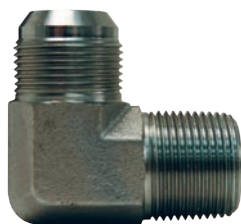

Male JIC 37° Flare	Male NPTF	PSI	Zinc Plated Steel Part #	316 Stainless Steel Part #
7/16"-20	1/8"-27	4500	2501-4-2	---
	1/4"-18	4500	2501-4-4	SS2501-4-4
	3/8"-18	4000	2501-4-6	---
9/16"-18	1/8"-27	4000	2501-6-2	---
	1/4"-18	4000	2501-6-4	---
	3/8"-18	4000	2501-6-6	SS2501-6-6
3/4"-16	1/2"-14	3000	2501-6-8	---
	1/4"-18	4000	2501-8-4	---
	3/8"-18	4000	2501-8-6	---
	1/2"-14	3000	2501-8-8	SS2501-8-8
7/8"-14	3/4"-14	2500	2501-8-12	---
	1/2"-14	3000	2501-10-8	---
	3/4"-14	2500	2501-10-12	---
1-1/16"-12	1/2"-14	3000	2501-12-8	---
	3/4"-14	2500	2501-12-12	SS2501-12-12
	1"-11-1/2	2000	2501-12-16	---
1-5/16"-12	3/4"-14	2500	2501-16-12	---
	1"-11-1/2	2000	2501-16-16	SS2501-16-16
1-5/8"-12	1"-11-1/2	2000	2501-20-16	---
	1-1/4"-11-1/2	1150	2501-20-20	---
1-7/8"-12	1-1/2"-11-1/2	1000	2501-24-24	---
2-1/2"-12	2"-11-1/2	1000	2501-32-32	---

#### 90° Female Swivel x Male NPTF Elbows

**Specification**

- Pressure rating at 70°F (21°C)



Female JIC 37° Swivel	Male NPTF	PSI	Zinc Plated Steel Part #
7/16"-20	1/8"-27	4500	6501-4-2
	1/4"-18	4500	6501-4-4
1/2"-20	1/8"-27	4000	6501-5-2
9/16"-18	1/4"-18	4000	6501-6-4
	3/8"-18	4000	6501-6-6
3/4"-16	3/8"-18	4000	6501-8-6
	1/2"-14	3000	6501-8-8
7/8"-14	1/2"-14	3000	6501-10-8
1-1/16"-12	3/4"-14	2500	6501-12-12
1-3/16"-12	3/4"-14	2500	6501-14-12
1-5/16"-12	1"-11-1/2	2000	6501-16-16
1-5/8"-12	1-1/4"-11-1/2	1150	6501-20-20
1-7/8"-12	1-1/2"-11-1/2	1000	6501-24-24
2-1/2"-12	2"-11-1/2	1000	6501-32-32

#### 45° Male Flare x Female Swivel Elbows

**Specifications**

- Reference SAE 070321
- Pressure rating at 70°F (21°C)



Male JIC 37°	Female JIC 37° Swivel	PSI	Zinc Plated Steel Part #
7/16"-20	7/16"-20	4500	6502-4
9/16"-18	9/16"-18	4000	6502-6
3/4"-16	3/4"-16	4000	6502-8
7/8"-14	7/8"-14	3000	6502-10
1 1/16"-12	1 1/16"-12	3000	6502-12
1 5/16"-12	1 5/16"-12	2500	6502-16
1-5/8"-12	1-5/8"-12	2000	6502-20

K

## Hydraulic Adapters - 37° JIC

### 45° Male Flare x Male NPTF Elbows

#### Specifications

- Reference SAE 070302
- Pressure rating at 70°F (21°C)

Male JIC 37° Flare	Male NPTF	PSI	Zinc Plated Steel Part #
7/16"-20	1/8"-27	4500	2503-4-2
	1/4"-18	4500	2503-4-4
9/16"-18	1/4"-18	4000	2503-6-4
	3/8"-18	4000	2503-6-6
3/4"-16	1/4"-18	4000	2503-8-4
	3/8"-18	4000	2503-8-6
	1/2"-14	3000	2503-8-8
7/8"-14	1/2"-14	3000	2503-10-8
	3/4"-14	2500	2503-10-12
1-1/16"-12	3/4"-14	2500	2503-12-12
1-5/16"-12	3/4"-14	2500	2503-16-12
	1"-11-1/2	2000	2503-16-16



### Male Flare Union Tees

#### Specifications

- Reference SAE 070401
- Pressure rating at 70°F (21°C)

Male JIC 37° Flare (3)	PSI	Zinc Plated Steel Part #
7/16"-20	5000	2603-4
9/16"-18	5000	2603-6
3/4"-16	4500	2603-8
7/8"-14	3500	2603-10
1-1/16"-12	3500	2603-12
1-5/16"-12	3000	2603-16



### Male Flare x Female Swivel Tees

#### Specifications

- Reference SAE 070433
- Pressure rating at 70°F (21°C)

Male JIC 37° Flare (2)	Female JIC 37° Swivel	PSI	Zinc Plated Steel Part #
7/16"-20	7/16"-20	4500	6600-4
9/16"-18	9/16"-18	4000	6600-6
3/4"-16	3/4"-16	4000	6600-8
1 1/16"-12	1 1/16"-12	3000	6600-12
1 5/16"-12	1 5/16"-12	2500	6600-16



### Male Flare x Female Swivel Branch Tees

#### Specifications

- Reference SAE 070432
- Pressure rating at 70°F (21°C)

Male JIC 37° Flare (2)	Female JIC 37° Swivel	PSI	Zinc Plated Steel Part #
7/16"-20	7/16"-20	4500	6602-4
9/16"-18	9/16"-18	4000	6602-6
3/4"-16	3/4"-16	4000	6602-8
7/8"-14	7/8"-14	3000	6602-10
1-1/16"-12	1-1/16"-12	3000	6602-12
1-5/16"-12	1-5/16"-12	2500	6602-16
1-5/8"-12	1-5/8"-12	2000	6602-20



### Male Flare x Male NPTF Branch Tees

#### Specifications

- Reference SAE 070425
- Pressure rating at 70°F (21°C)

Male JIC 37° Flare (2)	Male NPTF	PSI	Zinc Plated Steel Part #
7/16"-20	1/4"-18	5000	2601-4-4-4
	1/4"-18	5000	2601-6-6-4
9/16"-18	3/8"-18	4000	2601-6-6-6
	1/2"-14	3000	2601-8-8-8
3/4"-16	1/2"-14	3000	2601-10-10-8
	3/4"-14	2500	2601-12-12-12
1-1/16"-12	3/4"-14	2500	2601-12-12-12
1-5/16"-12	1"-11-1/2	2000	2601-16-16-16



## Hydraulic Adapters - 37° JIC

### Flare Caps

**Specifications**

- Reference SAE 070112
- Pressure rating at 70°F (21°C)



Female JIC 37° Flare	Tube O.D.	PSI	Zinc Plated Steel Part #
5/16"-24	1/8"	5000	0304C-2
7/16"-20	1/4"	5000	0304C-4
9/16"-18	3/8"	5000	0304C-6
3/4"-16	1/2"	4500	0304C-8
7/8"-14	5/8"	3500	0304C-10
1-1/16"-12	3/4"	3500	0304C-12
1-5/16"-12	1"	3000	0304C-16
1-5/8"-12	1-1/4"	2500	0304C-20
1-7/8"-12	1-1/2"	2000	0304C-24
2-1/2"-12	2"	1500	0304C-32

### Flare Tube Nuts

**Specifications**

- Reference SAE 070110
- Pressure rating at 70°F (21°C)

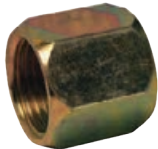

Female JIC 37° Flare	Tube O.D.	PSI	Zinc Plated Steel Part #
7/16"-20	1/4"	5000	0318-4
9/16"-18	3/8"	5000	0318-6
3/4"-16	1/2"	4500	0318-8
7/8"-14	5/8"	3500	0318-10
1-1/16"-12	3/4"	3500	0318-12
1-5/16"-12	1"	3000	0318-16

### Screw Thread Plugs

**Specifications**

- Reference SAE 070109
- Pressure rating at 70°F (21°C)



Male JIC 37° Flare	PSI	Zinc Plated Steel Part #
5/16"-24	5000	1254-02H
7/16"-20	5000	1254-04H
9/16"-18	5000	1254-06H
3/4"-16	4500	1254-08H
7/8"-14	3500	1254-10H
1-1/16"-12	3500	1254-12H
1-5/16"-12	3000	1254-16H
1-5/8"-12	2500	1254-20H

### Flare Tube Sleeves

**Specifications**

- Reference SAE 070115
- Pressure rating at 70°F (21°C)



Female JIC 37° Flare	PSI	Zinc Plated Steel Part #
7/16"-20	5000	0319-4
9/16"-18	5000	0319-6
3/4"-16	4500	0319-8
7/8"-14	3500	0319-10
1-1/16"-12	3500	0319-12
1-5/16"-12	3000	0319-16

### Flare Bulkhead Unions with Lock Nut

**Specifications**

- Reference SAE 070601
- Pressure rating at 70°F (21°C)



Male JIC 37° Flare	PSI	Zinc Plated Steel Part #
7/16"-20	5000	2700LN-4
9/16"-18	5000	2700LN-6
3/4"-16	4500	2700LN-8
7/8"-14	3500	2700LN-10
1-1/16"-12	3500	2700LN-12
1-5/16"-12	3000	2700LN-16

K

### Hydraulic Adapters - 37° JIC

#### Flare 90° Bulkhead Elbow with Lock Nuts

**Specifications**

- Reference SAE 070701
- Pressure rating at 70°F (21°C)

Male JIC 37° Flare	PSI	Zinc Plated Steel Part #
7/16"-20	5000	2701LN-4
9/16"-18	5000	2701LN-6
3/4"-16	4500	2701LN-8
7/8"-14	3500	2701LN-10
1-1/16"-12	3500	2701LN-12
1-5/16"-12	3000	2701LN-16



#### Flare Bulkhead Lock Nuts

**Specifications**

- Reference SAE 070118
- Pressure rating at 70°F (21°C)

Female JIC 37° Bulkhead	Tube O.D.	PSI	Zinc Plated Steel Part #
7/16"-20	1/4"	5000	0306-4
9/16"-18	3/8"	5000	0306-6
3/4"-16	1/2"	4500	0306-8
7/8"-14	5/8"	3500	0306-10
1-1/16"-12	3/4"	3500	0306-12
1-5/16"-12	1"	3000	0306-16

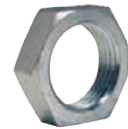

## Weld End Metal Hose Fittings

### Straight Female

All fittings have 316 seamless stainless steel tubes

#### Specification

- Pressure rating at 70°F (21°C)

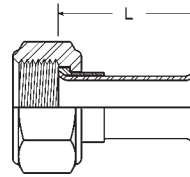

Female SAE 37° JIC	Tube O.D.	Pressure Rating PSI at 70°F (21°)	Dimension L	Tube Wall	304 Stainless Steel Nut & Sleeve Part #	Carbon Steel Nut & Sleeve Part #
7/16" - 20	1/4"	8650	1.500"	.049"	SFMF250	FMF250
9/16" - 18	3/8"	5550	1.500"	.049"	SFMF375	FMF375
3/4" - 16	1/2"	4050	1.500"	.049"	SFMF500	FMF500
1-1/16" - 12	3/4"	2600	1.500"	.049"	SFMF750	FMF750
1-5/16" - 12	1"	1950	2.000"	.049"	SFMF1000	FMF1000
1-5/8" - 12	1-1/4"	2050	2.375"	.065"	SFMF1250	FMF1250
1-7/8" - 12	1-1/2"	1700	2.375"	.065"	SFMF1500	FMF1500
2-1/2" - 12	2"	1250	2.500"	.065"	SFMF2000	FMF2000

### 45° Elbow Female

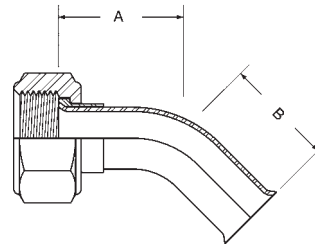

Female SAE 37° JIC	Tube O.D.	Pressure Rating PSI at 70°F (21°)	Dimension		Bend Radius	Tube Wall	304 Stainless Steel Nut & Sleeve Part #	Carbon Steel Nut & Sleeve Part #
			A	B				
7/16" - 20	1/4"	5000	0.750"	0.750"	0.380"	.049"	---	FMF250-45
9/16" - 18	3/8"	4500	1.000"	1.000"	0.500"	.049"	---	FMF375-45
3/4" - 16	1/2"	4000	1.250"	1.250"	1.000"	.049"	SFMF500-45	FMF500-45
1-1/16" - 12	3/4"	2600	1.450"	1.450"	1.500"	.049"	SFMF750-45	---
1-5/16" - 12	1"	2500	1.800"	1.800"	2.000"	.049"	SFMF1000-45	FMF1000-45
1-5/8" - 12	1-1/4"	2050	2.100"	2.100"	2.000"	.065"	---	FMF1250-45
1-7/8" - 12	1-1/2"	1700	2.300"	2.300"	2.000"	.065"	SFMF1500-45	FMF1500-45
2-1/2" - 12	2"	1250	3.000"	3.000"	3.000"	.065"	SFMF2000-45	FMF2000-45

### 90° Elbow Female

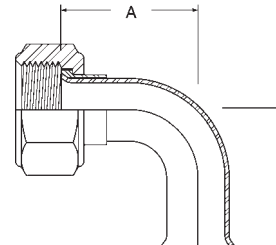

Female SAE 37° JIC	Tube O.D.	Pressure Rating PSI at 70°F (21°)	Dimension		Bend Radius	Tube Wall	304 Stainless Steel Nut & Sleeve Part #	Carbon Steel Nut & Sleeve Part #
			A	B				
7/16" - 20	1/4"	5000	1.000"	1.000"	0.375"	.049"	SFMF250-90	FMF250-90
9/16" - 18	3/8"	4500	1.250"	1.250"	0.500"	.049"	SFMF375-90	FMF375-90
3/4" - 16	1/2"	4000	1.830"	1.830"	1.000"	.049"	SFMF500-90	FMF500-90
1-1/16" - 12	3/4"	2600	2.350"	2.350"	1.500"	.049"	SFMF750-90	FMF750-90
1-5/16" - 12	1"	2500	3.100"	3.100"	2.000"	.049"	SFMF1000-90	FMF1000-90
1-5/8" - 12	1-1/4"	2050	3.500"	3.500"	2.000"	.065"	SFMF1250-90	FMF1250-90
1-7/8" - 12	1-1/2"	1700	3.750"	3.750"	2.000"	.065"	SFMF1500-90	FMF1500-90
2-1/2" - 12	2"	1250	4.900"	4.900"	2.000"	.065"	SFMF2000-90	FMF2000-90



### Hydraulic Adapters - NPTF

#### Male Hex Pipe Nipples

**Specifications**

- Reference SAE 140137
- Pressure rating at 70°F (21°C)

Male NPTF	Male NPTF	PSI	Zinc Plated Steel Part #
1/8"-27	1/8"-27	5000	5404-2
1/4"-18	1/4"-18	5000	5404-4
3/8"-18	3/8"-18	4000	5404-6
	1/4"-18	4000	5404-6-4
1/2"-14	1/2"-14	3000	5404-8
	3/8"-18	3000	5404-8-6
3/4"-14	3/4"-14	2500	5404-12
	1/2"-14	2500	5404-12-8
1"-11-1/2	1"-11-1/2	2000	5404-16
	3/4"-14	2000	5404-16-12
1-1/4"-11-1/2	1-1/4"-11-1/2	1150	5404-20



#### Male x Female Hex Reducer Bushings

**Specifications**

- Reference SAE 140140
- Pressure rating at 70°F (21°C)

Male NPTF	Female NPTF	PSI	Zinc Plated Steel Part #
1/4"-18	1/8"-27	5000	5406-4-2
3/8"-18	1/8"-27	4000	5406-6-2
	1/4"-18	4000	5406-6-4
1/2"-14	1/8"-27	3000	5406-8-2
	1/4"-18	3000	5406-8-4
	3/8"-18	3000	5406-8-6
3/4"-14	1/8"-27	2500	5406-12-2
	1/4"-18	2500	5406-12-4
	3/8"-18	2500	5406-12-6
	1/2"-14	2500	5406-12-8
1"-11-1/2	1/4"-18	2000	5406-16-4
	3/8"-18	2000	5406-16-6
	1/2"-14	2000	5406-16-8
	3/4"-14	2000	5406-16-12
1-1/4"-11-1/2	3/8"-18	1150	5406-20-6
	1/2"-14	1150	5406-20-8
	3/4"-14	1150	5406-20-12
	1"-11-1/2	1150	5406-20-16
1-1/2"-11-1/2	1/2"-14	1000	5406-24-8
	3/4"-14	1000	5406-24-12
	1"-11-1/2	1000	5406-24-16
	1-1/4"-11-1/2	1000	5406-24-20
2"-11-1/2"	1/2"-14	1000	5406-32-8
	3/4"-14	1000	5406-32-12
	1"-11-1/2	1000	5406-32-16
	1-1/4"-11-1/2	1000	5406-32-20
	1-1/2"-11-1/2	1000	5406-32-24



**K**

#### 90° Male x Male Elbows

**Specifications**

- Reference SAE 140237
- Pressure rating at 70°F (21°C)

Male NPTF	Male NPTF	PSI	Zinc Plated Steel Part #
1/4"-18	1/4"-18	5000	5500-4
3/8"-18	3/8"-18	4000	5500-6
1/2"-14	1/2"-14	3000	5500-8
3/4"-14	3/4"-14	2500	5500-12
1"-11-1/2	1"-11-1/2	2000	5500-16



### Hydraulic Adapters - NPTF

**Features**

- Compact design provides ease of assembly in confining areas
- Designed to prevent hose stress due to twisting during assembly
- Female NPSM swivel seals on a 30° seat
- Male NPTF must have a 30° chamfer to seal

**Male x Female NPSM Swivel Adapters**

**Specifications**

- Reference SAE 140130
- Pressure rating at 70°F (21°C)

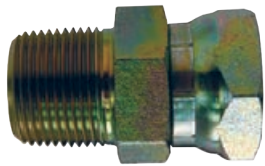

Male NPTF	Female NPSM Swivel	PSI	Zinc Plated Steel Part #
1/8"-27	1/8"-27	5000	1404-2-2
	1/4"-18	4500	1404-2-4
1/4"-18	1/4"-18	4500	1404-4-4
	3/8"-18	4000	1404-4-6
3/8"-18	1/4"-18	4000	1404-6-4
	3/8"-18	4000	1404-6-6
	1/2"-14	4000	1404-6-8
1/2"-14	3/8"-18	3000	1404-8-6
	1/2"-14	3000	1404-8-8
	3/4"-14	3000	1404-8-12
3/4"-14	1/2"-14	2500	1404-12-8
	3/4"-14	2500	1404-12-12
1"-11-1/2	1"-11-1/2	2000	1404-16-16
1-1/4"-11-1/2	1-1/4"-11-1/2	1150	1404-20-20
1-1/2"-11-1/2	1-1/2"-11-1/2	1000	1404-24-24
2"-11-1/2	2"-11-1/2	1000	1404-32-32

### Female Hex Pipe Couplings

**Specifications**

- Reference SAE 140138
- Pressure rating at 70°F (21°C)



Female NPTF	Female NPTF	PSI	Zinc Plated Steel Part #
1/8"-27	1/8"-27	5000	5000-2
1/4"-18	1/4"-18	5000	5000-4
	1/4"-18	4000	5000-6-4
3/8"-18	3/8"-18	4000	5000-6
	3/8"-18	3000	5000-8-6
1/2"-14	1/2"-14	3000	5000-8
	3/4"-14	2500	5000-12
1"-11-1/2	3/4"-14	2000	5000-16-12
	1"-11-1/2	2000	5000-16
1-1/4"-11-1/2	1-1/4"-11-1/2	1150	5000-20

### Female x Female NPSM Swivel Nuts

**Specifications**

- Reference SAE 140131
- Pressure rating at 70°F (21°C)



Female NPTF	Female NPSM Swivel	PSI	Zinc Plated Steel Part #
1/8"-27	1/8"-27	5000	1405-2-2
1/4"-18	1/4"-18	4500	1405-4-4
	1/4"-18	4000	1405-6-4
3/8"-18	3/8"-18	4000	1405-6-6
	1/2"-14	4000	1405-6-8
1/2"-14	1/2"-14	3000	1405-8-8
	1/2"-14	2500	1405-12-8
3/4"-14	3/4"-14	2500	1405-12-12
	1"-11-1/2	2000	1405-16-16
1-1/4"-11-1/2	1-1/4"-11-1/2	1150	1405-20-20
1-1/2"-11-1/2	1-1/2"-11-1/2	1000	1405-24-24
2"-11-1/2	2"-11-1/2	1000	1405-32-32

K

## Hydraulic Adapters - NPTF

### 90° Male x Female Street Elbows

#### Specifications

- Reference 140239
- Pressure rating at 70°F (21°C)

Male NPTF	Female NPTF	PSI	Zinc Plated Steel Part #
1/4"-18	-1/4"-18	5000	5502-4
3/8"-18	3/8"-18	4000	5502-6
1/2"-14	1/2"-14	3000	5502-8
3/4"-14	3/4"-14	2500	5502-12
1"-11-1/2	1"-11-1/2	2000	5502-16
1-1/4"-11-1/2	1-1/4"-11-1/2	1150	5502-20



### 90° Male x Female NPSM Swivel Nut Elbows

#### Specifications

- Reference SAE 140230
- Pressure rating at 70°F (21°C)

Male NPTF	Female NPSM Swivel	PSI	Zinc Plated Steel Part #
1/8"-27	1/8"-27	5000	1501-2-2
1/4"-18	1/4"-18	4500	1501-4-4
	3/8"-18	4000	1501-4-6
3/8"-18	1/4"-18	4000	1501-6-4
	3/8"-18	4000	1501-6-6
	1/2"-14	4000	1501-6-8
1/2"-14	3/8"-18	3000	1501-8-6
	1/2"-14	3000	1501-8-8
3/4"-14	3/4"-14	3000	1501-8-12
	1/2"-14	2500	1501-12-8
	3/4"-14	2500	1501-12-12
1"-11-1/2	1"-11-1/2	2000	1501-12-16
	3/4"-14	2000	1501-16-12
	1"-11-1/2	2000	1501-16-16
1-1/4"-11-1/2	1-1/4"-11-1/2	1150	1501-16-20
	1-1/4"-11-1/2	1150	1501-20-20



### 90° Female Pipe Elbows

#### Specifications

- Reference SAE 140237
- Pressure rating at 70°F (21°C)

Female NPTF	Female NPTF	PSI	Zinc Plated Steel Part #
1/8"-27	1/8"-27	5000	5504-2
1/4"-18	1/4"-18	5000	5504-4
3/8"-18	3/8"-18	4000	5504-6
1/2"-14	1/2"-14	3000	5504-8
3/4"-14	3/4"-14	2500	5504-12
1"-11-1/2	1"-11-1/2	2000	5504-16



### 90° Female x Female NPSM Swivel Nut Elbows

#### Specifications

- Reference SAE 140251
- Pressure rating at 70°F (21°C)

Female NPTF	Female NPSM Swivel	PSI	Zinc Plated Steel Part #
1/4"-18	1/4"-18	4500	1502-4-4
3/8"-18	3/8"-18	4000	1502-6-6
1/2"-14	1/2"-14	3000	1502-8-8
3/4"-14	3/4"-14	2500	1502-12-12
1"-11-1/2	1"-11-1/2	2000	1502-16-16



### 45° Male x Female NPSM Swivel Nut Elbows

#### Specifications

- Reference SAE 140330
- Pressure rating at 70°F (21°C)

Male NPTF	Female NPSM Swivel	PSI	Zinc Plated Steel Part #
1/4"-18	1/4"-18	4500	1503-4-4
3/8"-18	3/8"-18	4000	1503-6-6
1/2"-14	1/2"-14	3000	1503-8-8
3/4"-14	3/4"-14	2500	1503-12-12
1"-11-1/2	1"-11-1/2	2000	1503-16-16



### Hydraulic Adapters - NPTF

#### Male Pipe Tees

**Specifications**

- Reference SAE 140437
- Pressure rating at 70°F (21°C)



Male NPTF (3)	PSI	Zinc Plated Steel Part #
1/4"-18	5000	5600-4
3/8"-18	4000	5600-6
1/2"-14	3000	5600-8
3/4"-14	2500	5600-12
1"-11-1/2	2000	5600-16

#### Male x Female Pipe Tees

**Specifications**

- Reference SAE 140427
- Pressure rating at 70°F (21°C)



Male NPTF (2)	Female NPTF	PSI	Zinc Plated Steel Part #
1/4"-18	1/4"-18	5000	5601-4
3/8"-18	3/8"-18	4000	5601-6
1/2"-14	1/2"-14	3000	5601-8
3/4"-14	3/4"-14	2500	5601-12
1"-11-1/2	1"-11-1/2	2000	5601-16

#### Female x Male Branch Tees

**Specifications**

- Reference SAE 140425
- Pressure rating at 70°F (21°C)



Female NPTF (2)	Male NPTF	PSI	Zinc Plated Steel Part #
1/4"-18	1/4"-18	5000	5604-4
3/8"-18	3/8"-18	4000	5604-6
1/2"-14	1/2"-14	3000	5604-8
3/4"-14	3/4"-14	2500	5604-12
1"-11-1/2	1"-11-1/2	2000	5604-16

#### Female Pipe Tees

**Specifications**

- Reference 140438
- Pressure rating at 70°F (21°C)



Female NPTF (3)	PSI	Zinc Plated Steel Part #
1/4"-18	5000	5605-4
3/8"-18	4000	5605-6
1/2"-14	3000	5605-8
3/4"-14	2500	5605-12
1"-11-1/2	2000	5605-16

#### Male x Female Run Tees

**Specifications**

- Reference 140424
- Pressure rating at 70°F (21°C)



Male NPTF	Female NPTF (2)	PSI	Zinc Plated Steel Part #
1/8"-27	1/8"-27	5000	5602-2
1/4"-18	1/4"-18	5000	5602-4
3/8"-18	3/8"-18	4000	5602-6
1/2"-14	1/2"-14	3000	5602-8
3/4"-14	3/4"-14	2500	5602-12
1"-11-1/2	1"-11-1/2	2000	5602-16
1-1/4"-11-1/2	1-1/4"-11-1/2	1150	5602-20
1-1/2"-11-1/2	1-1/2"-11-1/2	1000	5602-24

K

## Hydraulic Adapters - NPTF

### Female Hex Caps

**Specification**

- Pressure rating at 70°F (21°C)

Female NPTF	PSI	Zinc Plated Steel Part #
1/8"-27	5000	5406C-2
1/4"-18	5000	5406C-4
3/8"-18	4000	5406C-6
1/2"-14	3000	5406C-8
3/4"-14	2500	5406C-12
1"-11-1/2	2000	5406C-16
1-1/4"-11-1/2	1150	5406C-20
1-1/2"-11-1/2	1000	5406C-24



### Male Hex Plugs

**Specifications**

- Reference SAE 130109C
- Pressure rating at 70°F (21°C)

Male NPTF	PSI	Zinc Plated Steel Part #
1/8"-27	5000	1251-02H
1/4"-18	5000	1251-04H
3/8"-18	4000	1251-06H
1/2"-14	3000	1251-08H
3/4"-14	2500	1251-12H
1"-11-1/2	2000	1251-16H
1-1/4"-11-1/2	1150	1251-20H



### Male JIC 37° Flare x Male Metric Parallel Thread

**Specification**

- Pressure rating at 70°F (21°C)

Male JIC 37° Flare	Male Metric Parallel	Zinc Plated Steel Part #
7/16"-20	M10X1.0	M7400-4-10
	M12X1.5	M7400-4-12
9/16"-18	M14X1.5	M7400-6-14
	M16X1.5	M7400-6-16
3/4"-16	M16X1.5	M7400-8-16
	M18X1.5	M7400-8-18
1-1/16"-12	M22X1.5	M7400-12-22
	M27X2.0	M7400-12-27
1-5/16"-12	M33X2.0	M7400-16-33



### Female Pipe x Male Metric Parallel Thread

**Specification**

- Pressure rating at 70°F (21°C)

Female NPTF	Male Metric Parallel	Zinc Plated Steel Part #
1/4"-18	M12X1.5	M7455-4-12
	M14X1.5	M7455-4-14
3/8"-18	M16X1.5	M7455-6-16
	M18X1.5	M7455-6-18
1/2"-14	M16X1.5	M7455-8-16
	M18X1.5	M7455-8-18
3/4"-14	M22X1.5	M7455-8-22
	M27X2.0	M7455-12-27
1"-11-1/2	M33X2.0	M7455-16-33



**Hydraulic Adapters - British Standard Pipe Parallel (BSPP)**

**Male JIC 37° Flare x Male**

**Specification**

- Pressure rating at 70°F (21°C)



Male JIC 37° Flare	Male BSPP	PSI	Zinc Plated Steel Part #
7/16"-20	1/4"-19	5000	B3800-4-4
9/16"-18	3/8"-19	4000	B3800-6-6
3/4"-16	1/2"-14	3000	B3800-8-8
1-1/16"-12	3/4"-14	2500	B3800-12-12
1-5/16"-12	1"-11	2000	B3800-16-16

**Male NPTF x Male**

**Specification**

- Pressure rating at 70°F (21°C)



Male NPTF	Male BSPP	PSI	Zinc Plated Steel Part #
1/4"-18	1/4"-19	5000	B3401-4-4
3/8"-18	3/8"-19	4000	B3401-6-6
1/2"-14	1/2"-14	3000	B3401-8-8
3/4"-14	3/4"-14	2500	B3401-12-12
1"-11-1/2	1"-11	2000	B3401-16-16

**Female NPTF x Male**

**Specification**

- Pressure rating at 70°F (21°C)



Female NPTF	Male BSPP	PSI	Zinc Plated Steel Part #
1/4"-18	1/4"-19	5000	B3455-4-4
3/8"-18	3/8"-19	4000	B3455-6-6
1/2"-14	1/2"-14	3000	B3455-8-8
3/4"-14	3/4"-14	2500	B3455-12-12
1"-11-1/2	1"-11	2000	B3455-16-16

**Male JIC 37° Flare x Male 90° Elbow**

**Specification**

- Pressure rating at 70°F (21°C)



Male JIC 37° Flare	Male BSPP	PSI	Zinc Plated Steel Part #
7/16"-20	1/4"-19	5000	B3801-4-4
9/16"-18	3/8"-19	4000	B3801-6-6
3/4"-16	1/2"-14	3000	B3801-8-8
1-1/16"-12	3/4"-14	2500	B3801-12-12
1-5/16"-12	1"-11	2000	B3801-16-16

**Bonded Dowty Seal for British Thread**

**Specification**

- Pressure rating at 70°F (21°C)



Size	Plated Carbon Steel with Nitrile Rubber O-ring Part #
1/4"-19	BDS04
3/8"-19	BDS06
1/2"-14	BDS08
3/4"-14	BDS12
1"-11	BDS16

K

## Hydraulic Adapters - Flareless Bite Fittings

### Applications

- Chemical, pulp and paper, oil and gas refineries, military, air compressors, and machine tools
- Well-suited for a variety of processing and general hydraulic applications

### Features

- Ideally suited for use with tubing having medium to extra heavy wall thicknesses
- 3-piece design with only one ferrule eliminates possible make-up errors that may occur using a twin ferrule tube fitting
- Minimal risk of improper assembly as the ferrule visibly bites into the tubing, allowing installer to visually inspect the bite quality
- Fittings are suitable for sub-zero through elevated temperature applications

### Specifications

- Temperature rating is limited by the material chosen
- Pressure ratings are determined by the size (O.D.) and wall thickness (inches/mm) of the tubing on which they are to be installed

### Approval

- Exceeds Military (MIL F18866) and SAE J514 standards

### Assembly Instructions

- Cut, deburr and clean tubing
- Pre-set ferrule onto tubing
- Inspect ferrule bite in tubing by disassembling the fitting and visually inspecting the deburred end of tube for slight indentation
- Finger tighten nut and then further wrench tighten nut another 1/3 to 1/2 turn

### Male Tube x Male NPTF Adapters

Tube O.D.	Male NPTF	Steel Part #
1/8"	1/8"	FLC2404-02
	1/4"	FLC2404-02-04
3/16"	1/8"	FLC2404-03-02
1/4"	1/8"	FLC2404-04-02
	1/4"	FLC2404-04
	3/8"	FLC2404-04-06
	1/2"	FLC2404-04-08
5/16"	1/8"	FLC2404-05-02
	1/4"	FLC2404-05-04
3/8"	1/8"	FLC2404-06-02
	1/4"	FLC2404-06-04
	3/8"	FLC2404-06
	1/2"	FLC2404-06-08
1/2"	1/4"	FLC2404-08-04
	3/8"	FLC2404-08-06
	1/2"	FLC2404-08
	3/4"	FLC2404-08-12
5/8"	3/8"	FLC2404-10-06
	1/2"	FLC2404-10-08
	3/4"	FLC2404-10-12
3/4"	1/2"	FLC2404-12-08
	3/4"	FLC2404-12
	1"	FLC2404-12-16
1"	3/4"	FLC2404-16-12
	1"	FLC2404-16
	1-1/4"	FLC2404-16-20
1-1/4"	3/4"	FLC2404-20-12
	1-1/4"	FLC2404-20
1-1/2"	1-1/2"	FLC2404-24

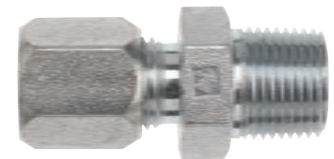

**K**

### Male Tube x Male 37° JIC

Tube O.D.	Male 37° JIC	Steel Part #
1/4"	1/4"	FLC2402-04-04
3/8"	3/8"	FLC2402-06-06
1/2"	1/2"	FLC2402-08-08
3/4"	3/4"	FLC2402-12-12



**Hydraulic Adapters - Flareless Bite Fittings**

**Male Tube x Female NPTF Adapters**

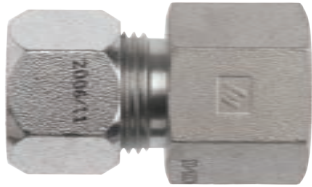

Tube O.D.	Female NPTF	Steel Part #
1/8"	1/8"	FLC2405-02
1/4"	1/8"	FLC2405-04-02
	1/4"	FLC2405-04
5/16"	1/8"	FLC2405-05-02
3/8"	1/4"	FLC2405-06-04
	3/8"	FLC2405-06
1/2"	1/4"	FLC2405-08-04
	3/8"	FLC2405-08-06
	1/2"	FLC2405-08
5/8"	1/2"	FLC2405-10-08
3/4"	3/4"	FLC2405-12
1"	1"	FLC2405-16
1-1/4"	1-1/4"	FLC2405-20

**Tube Unions**

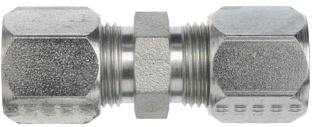

Tube O.D.	Steel Part #
1/8"	FLC2403-02
3/16"	FLC2403-03
1/4"	FLC2403-04
5/16"	FLC2403-05
3/8"	FLC2403-06
1/2"	FLC2403-08
5/8"	FLC2403-10
3/4"	FLC2403-12
1"	FLC2403-16
1-1/4"	FLC2403-20
1-1/2"	FLC2403-24

**Male Tube x Male NPTF Adapter 90° Elbows**

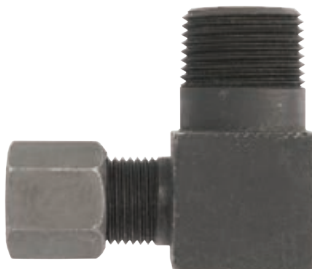

Tube O.D.	Male NPTF	Steel Part #
1/8"	1/8"	FLC2501-02
3/16"	1/8"	FLC2501-03-02
	1/8"	FLC2501-04-02
1/4"	1/4"	FLC2501-04
	3/8"	FLC2501-04-06
5/16"	1/8"	FLC2501-05-02
	1/4"	FLC2501-05-04
3/8"	1/8"	FLC2501-06-02
	1/4"	FLC2501-06-04
	3/8"	FLC2501-06
1/2"	1/2"	FLC2501-06-08
	1/4"	FLC2501-08-04
	3/8"	FLC2501-08-06
5/8"	1/2"	FLC2501-08
	3/4"	FLC2501-08-12
	3/8"	FLC2501-10-06
3/4"	1/2"	FLC2501-10-08
	3/4"	FLC2501-12-08
1"	1/2"	FLC2501-12
	3/4"	FLC2501-16-12
1-1/4"	1"	FLC2501-16
	1-1/4"	FLC2501-20
1-1/2"	1-1/2"	FLC2501-24

K



## Hydraulic Adapters - Flareless Bite Fittings

### Male Union 90° Elbows

Tube O.D.	Steel Part #
1/4"	FLC2500-04
5/16"	FLC2500-05
3/8"	FLC2500-06
1/2"	FLC2500-08
5/8"	FLC2500-10
3/4"	FLC2500-12
1"	FLC2500-16
1-1/4"	FLC2500-20



### Male Tube Union Tees

Tube O.D.	Steel Part #
1/8"	FLC2603-02
3/16"	FLC2603-03
1/4"	FLC2603-04
5/16"	FLC2603-05
3/8"	FLC2603-06
1/2"	FLC2603-08
5/8"	FLC2603-10
3/4"	FLC2603-12
1"	FLC2603-16
1-1/4"	FLC2603-20

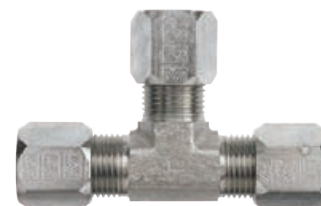

### Ferrules

Tube O.D.	Steel Part #
1/8"	FLC0319-02
3/16"	FLC0319-03
1/4"	FLC0319-04
5/16"	FLC0319-05
3/8"	FLC0319-06
1/2"	FLC0319-08
5/8"	FLC0319-10
3/4"	FLC0319-12
1"	FLC0319-16
1-1/4"	FLC0319-20
1-1/2"	FLC0319-24



### Nuts

Tube O.D.	Steel Part #
1/8"	FLC0318-02
3/16"	FLC0318-03
1/4"	FLC0318-04
5/16"	FLC0318-05
3/8"	FLC0318-06
1/2"	FLC0318-08
5/8"	FLC0318-10
3/4"	FLC0318-12
1"	FLC0318-16
1-1/4"	FLC0318-20
1-1/2"	FLC0318-24



## Flow Control Valves

### Steel Series-F

#### Features

- Two-step needle provides fine adjustments at low flow with the first three turns of the adjusting knob, the next three turns give full-open needle position and conventional throttling control. When flow is reversed, a heavy-duty poppet/retainer permits full-flow return capacity
- Color-coded reference scale simplifies flow setting, resetting, adjusting, and return to original flow; a simple set screw locks the valve on any desired setting

#### Specifications

- Maximum operating pressure:  
**5000 PSI at 70°F (21°C)** for 1/8" - 1/2"  
**3000 PSI at 70°F (21°C)** for 3/4" - 2"



Female NPTF	Black Oxide Steel Part #
1/8"	SFC200
1/4"	SFC400
3/8"	SFC600
1/2"	SFC800
3/4"	SFC1200
1"	SFC1600
1-1/2"	SFC2400
2"	SFC3200

### Steel Series-N

#### Features

- Excellent speed control on hydraulic systems where a reverse flow check valve is not needed
- Reliable shutoff in a very small envelope; color-coded reference scale simplifies setting, resetting, adjusting, and quick return to a previous speed setting

#### Specifications

- Maximum operating pressure:  
**5000 PSI at 70°F (21°C)** for 1/8" - 3/4"  
**3000 PSI at 70°F (21°C)** for 1" - 1-1/4"



Female NPTF	Steel Part #
1/8"	SN200
1/4"	SN400
3/8"	SN600
1/2"	SN800
3/4"	SN1200
1"	SN1600
1-1/4"	SN2000

### Series-MV Metering

#### Features

- Easily make fine adjustments and resets with color code feature that shows when desired setting is reached
- Body components are precision-turned from solid barstock

#### Material

- 416 stainless steel needle

#### Specification

- Maximum operating pressure: **5000 PSI at 70°F (21°C)**



Female NPTF	Steel Part #
1/4"	SMV400
3/8"	SMV600
1/2"	SMV800

K

## Series-C Check Valves

### Feature

- Provides free flow in one direction and dependable shutoff in the opposite direction

### Specifications

- Maximum operating pressure: **2000 PSI** at ambient temperature 70°F (21°C)
- Cracking pressure: **5 PSI**

Female NPT	Free Flow GPM	Maximum Operating PSI at 70°F (21°C)	Maximum Operating PSI at 70°F (21°C)	Steel Part #
1/8"	3	2000	5000	SCV200
1/4"	5	2000	5000	SCV400
3/8"	8	2000	5000	SCV600
1/2"	15	2000	5000	SCV800

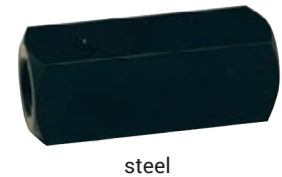

## High Pressure Full-Bore Ball Valves

### Features

- Blowout proof stem
- Rugged construction

### Materials

- FKM/FPM seals
- POM (Polyacetal) ball seats

Female NPT	PSI	Carbon Steel		PSI	316 Stainless Steel Part #
		Part #	SAE Part #		
1/4"	7350	HPBV25	HPBV25SAE	5880	HPBV25SS
3/8"	7350	HPBV38	HPBV38SAE	5880	HPBV38SS
1/2"	7350	HPBV12	HPBV12SAE	5880	HPBV12SS
3/4"	6000	HPBV34	HPBV34SAE	5145	HPBV34SS
1"	6000	HPBV10	HPBV10SAE	5145	HPBV10SS
1-1/4"	6000	HPBV125	HPBV125SAE	---	---
1-1/2"	6000	HPBV150	HPBV150SAE	---	---
2"	6000	HPBV200	HPBV200SAE	---	---



## High Pressure Clear Zinc Ball Valves

### Materials

- Nitrile rubber O-rings
- POM (Polyacetal) ball seats

### Approval

- RoHS compliant

Female NPT	PSI	Carbon Steel		PSI
		Part #	SAE Part #	
1/4"	7350	HPBV25ZPL	HPBV25SAEZPL	7350
3/8"	7350	HPBV38ZPL	HPBV38SAEZPL	7350
1/2"	7350	HPBV12ZPL	HPBV12SAEZPL	7350
3/4"	6000	HPBV34ZPL	HPBV34SAEZPL	6000
1"	6000	HPBV10ZPL	HPBV10SAEZPL	6000
1-1/4"	6000	HPBV125ZPL	HPBV125SAEZPL	6000
1-1/2"	6000	HPBV150ZPL	HPBV150SAEZPL	6000
2"	6000	HPBV200ZPL	HPBV200SAEZPL	6000



## High Pressure Full-Bore 3-Way Ball Valves

### Feature

- Rugged construction

### Specification

- Temperature range: -20°F to 215° F (-29°C to 102°C)

### Materials

- FKM seals
- POM (polyacetal) ball seats
- Black oxide coating
- Nickel plated ball

Female NPT	PSI	Carbon Steel Part #
1/2"	5145	HPBV12-3WAY
3/4"	5145	HPBV34-3WAY
1"	5145	HPBV10-3WAY



### Mini Needle Valves

**Features**

- Available in a variety of materials and handle options
- FKM O-ring seal and PTFE back-up ring below the threads protects from corrosion and galling
- Stem threads are rolled for strength and ease of operation

**Material**

- All stems are 316 stainless steel

**Specifications**

- Metal-to-metal hard seat design is 100% helium leak tested to 1 x 10<sup>-4</sup> ml/s at **200 PSI**
- 1/8" and 1/4" are orifice size: 0.172", flow coefficient: 0.42
- 1/2": orifice size are 0.187", flow coefficient: 0.44, hex body

**Male to Female**



NPT Size	Handle Style	PSI @ 200°F	Brass Part #	Handle Style	PSI @ 200°F	Zinc Nickel Plated Steel Part #	316 Stainless Steel Part #
1/8" - 27	knurled knob	6000	MFB101	T design	10000	MFC101	MFS101
1/4" - 18	knurled knob	6000	MFB102	T design	10000	MFC102	MFS102
1/2" - 14	---	---	---	T design	10000	MFC404	MFS404

**Female to Female**



NPT Size	Handle Style	PSI @ 200°F	Brass Part #	Handle Style	PSI @ 200°F	Zinc Nickel Plated Steel Part #	316 Stainless Steel Part #
1/8" - 27	knurled knob	6000	FFB101	T design	10000	FFC101	FFS101
1/4" - 18	knurled knob	6000	FFB102	T design	10000	FFC102	FFS102
1/2" - 14	---	---	---	T design	10000	FFC404	FFS404

### Multiport Needle Valves

**Features**

- Reduces the number of gauge and other instrument connections to permanent piping installations, decreasing possible leak paths
- FKM O-ring seal and PTFE back-up ring below the threads protects from corrosion and galling
- Stem threads are rolled for strength and ease of operation

**Material**

- All stems are 316 stainless steel

**Specifications**

- Metal-to-metal hard seat design is 100% helium leak tested to 1 x 10<sup>-4</sup> ml/s at **200 PSI**
- 1/2" female NPT port
- Orifice size is 0.187", flow coefficient: 0.44

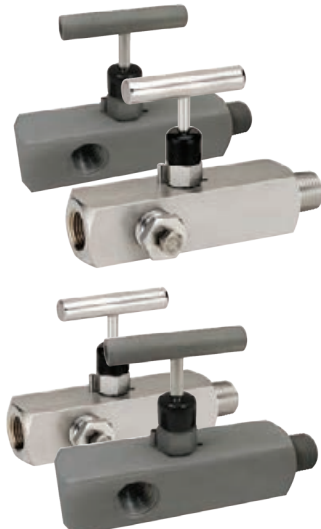

**Hard Seat Male to Female**

NPT Size	Handle Style	PSI @ 200°F	Zinc Nickel Plated Steel Part #	316 Stainless Steel Part #
1/2" - 14	T design	10000	MFC204	MFS204
3/4" - 14	T design	10000	MFC20604	MFS20604

**Soft Seat Male to Female**

NPT Size	Handle Style	PSI @ 200°F	Zinc Nickel Plated Steel Part #	316 Stainless Steel Part #
1/2" - 14	T design	6000	MFC304	MFS304
3/4" - 14	T design	6000	MFC30604	MFS30604

K

## Block and Bleed Needle Valves

### Features

- Allows pressure to be bled off without disturbing the permanent piping installation, allowing quick and easy removal or replacement of instruments
- FKM O-ring seal and PTFE back-up ring below the threads protects from corrosion and galling
- Stem threads are rolled for strength and ease of operation

### Material

- All stems are 316 stainless steel

### Specifications

- Metal-to-metal hard seat design is 100% helium leak tested to  $1 \times 10^{-4}$  ml/s at **200 PSI**
- Orifice size is 0.187", flow coefficient: 0.44
- 0.090" bleed hole located on bottom is controlled by a 1/4"-20 UNF-2A bleed screw

### Hard Seat Male to Female

NPT Size	Handle Style	PSI at 200°F	Zinc Nickel Plated Steel Part #	316 Stainless Steel Part #
1/4" - 18	T design	<b>10000</b>	MFC602	MFS602
1/2" - 14	T design	<b>10000</b>	MFC604	MFS604

### Soft Seat Male to Female

NPT Size	Handle Style	PSI at 200°F	Zinc Nickel Plated Steel Part #	316 Stainless Steel Part #
1/4" - 18	T design	<b>6000</b>	MFC702	MFS702
1/2" - 14	T design	<b>6000</b>	MFC704	MFS704

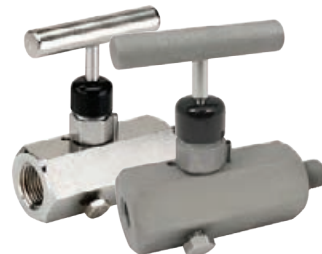

**K**

## Bleed Needle Valves

### Features

- Convenient way to relieve process pressures trapped between a shut-off valve and the instrument
- FKM O-ring seal and PTFE back-up ring below the threads protects from corrosion and galling
- Stem threads are rolled for strength and ease of operation

### Material

- All stems are 316 stainless steel

### Specifications

- Metal-to-metal hard seat design is 100% helium leak tested to  $1 \times 10^{-4}$  ml/s at **200 PSI**
- Non-rotating soft tip stem and a backup metal-to-metal seal
- 0.159" bleed port

### Hard Seat Male

NPT Size	Handle Style	PSI at 200°F	Zinc Nickel Plated Steel Part #	316 Stainless Steel Part #
1/4" - 18	T design	<b>10000</b>	MC802	MS802
1/2" - 14	T design	<b>10000</b>	MC804	MS804



316 stainless

### Soft Tip Male

NPT Size	Handle Style	PSI at 200°F	Zinc Nickel Plated Steel Part #	316 Stainless Steel Part #
1/4" - 18	T design	<b>6000</b>	MC852	MS852
1/2" - 14	T design	<b>6000</b>	MC854	MS854



316 stainless

### Hydraulic 4-Bolt Flanges

**Features**

- Flat face flange must be used with O-ring flange
- Code 61 - standard pressure; code 62 - high pressure
- Makes installation of components easier, especially in applications with limited space
- Bolt kit with nitrile rubber O-ring included with O-ring flange
- No bolt kit is included with flat face flange
- Also available in 316L stainless; contact Dixon® for more information

#### Hydraulic 4-Bolt Flange NPTF Port



Port Size	Pad Size	NPTF Thread	Code 61 Carbon Steel	
			O-ring Part #	Flat Face Part #
1/2"	1/2"	1/2"-14	C6143K0808NPT	C611040808NPT
3/4"	3/4"	3/4"-14	C6143K1212NPT	C611041212NPT
1"	1"	1"-11-1/2	C6143K1616NPT	C611041616NPT
1-1/4"	1-1/4"	1-1/4"-11-1/2	C6143K2020NPT	C611042020NPT
1-1/2"	1-1/2"	1-1/2"-11-1/2	C6143K2424NPT	C611042424NPT
2"	2"	2"-11-1/2	C6143K3232NPT	C611043232NPT
2-1/2"	2-1/2"	2-1/2"-8	C6143K4040NPT	C611044040NPT
3"	3"	3"-8	C6143K4848NPT	C611044848NPT

Port Size	Pad Size	NPTF Thread	Code 62 Carbon Steel	
			O-ring Part #	Flat Face Part #
1/2"	1/2"	1/2"-14	C6244K0808NPT	C62450808NPT
3/4"	3/4"	3/4"-14	C6244K1212NPT	C62451212NPT
1"	1"	1"-11-1/2	C6244K1616NPT	C62451616NPT
1-1/4"	1-1/4"	1-1/4"-11-1/2	C6244K2020NPT	C62452020NPT
1-1/2"	1-1/2"	1-1/2"-11-1/2	C6244K2424NPT	C62452424NPT
2"	2"	2"-11-1/2	C6244K3232NPT	C62453232NPT

#### Hydraulic 4-Bolt Flange SAE Port



1000 PSI maximum

Port Size	Pad Size	UN/UNF-2B Thread	Code 61 Carbon Steel	
			O-ring Part #	Flat Face Part #
1/2"	1/2"	3/4"-16	C6146K0808SAE	C611060808SAE
3/4"	3/4"	1-1/16"-12	C6146K1212SAE	C611061212SAE
1"	1"	1-5/16"-12	C6146K1616SAE	C611061616SAE
1-1/4"	1-1/4"	1-5/16"-12	C6146K2020SAE	C611062020SAE
1-1/2"	1-1/2"	1-7/8"-12	C6146K2424SAE	C611062424SAE
2"	2"	2-1/2"-12	C6146K3232SAE <sup>1</sup>	C611063232SAE

Port Size	Pad Size	UN/UNF-2B Thread	Code 62 Carbon Steel	
			O-ring Part #	Flat Face Part #
1/2"	1/2"	3/4"-16	C6248K0808SAE	C62490808SAE
3/4"	3/4"	1-1/16"-12	C6248K1212SAE	C62491212SAE
1"	1"	1-5/16"-12	C6248K1616SAE	C62491616SAE
1-1/4"	1-1/4"	1-5/8"-12	C6248K2020SAE	C62492020SAE
1-1/2"	1-1/2"	1-7/8"-12	C6248K2424SAE	C62492424SAE
2"	2"	2-1/2"-12	C6248K3232SAE	C62493232SAE

NOTE: For flange dimensions, diagrams and additional information please reference [dixonvalve.com](http://dixonvalve.com).

## Hydraulic 4-Bolt Flanges

### Hydraulic 4-Bolt Flange Pipe Socket Weld

Port Size	Pad Size	Code 61 Carbon Steel	
		O-ring Part #	Flat Face Part #
1/2"	1/2"	C614K0808PSW	C61610808PSW
3/4"	3/4"	C614K1212PSW	C61611212PSW
1"	1"	C614K1616PSW	C61611616PSW
1-1/4"	1-1/4"	C614K2020PSW	C61612020PSW
1-1/2"	1-1/2"	C614K2424PSW	C61612424PSW
2"	2"	C614K3232PSW	C61613232PSW
2-1/2"	2-1/2"	C614K4040PSW	C61614040PSW
3"	3"	C614K4848PSW	C61614848PSW



Port Size	Pad Size	Code 62 Carbon Steel	
		O-ring Part #	Flat Face Part #
1/2"	1/2"	C6259K0808PSW	C62600808PSW
3/4"	3/4"	C6259K1212PSW	C62601212PSW
1"	1"	C6259K1616PSW	C62601616PSW
1-1/4"	1-1/4"	C6259K2020PSW	C62602020PSW
1-1/2"	1-1/2"	C6259K2424PSW	C62602424PSW
2"	2"	C6259K3232PSW	C62603232PSW
2-1/2"	2-1/2"	C6259K4040PSW	C62604040PSW
3"	3"	C6259K4848PSW	C62604848PSW

### Pressure Ratings of SAE Flanges

#### Code 61 SAE J518-1 / ISO6162-1

Dash Size	Size	Maximum Working Pressure		Fastener Torque Value Grade 8 UNC (ft. lbs.)
		PSI	MPa	
-8	1/2"	5000	35	24
-12	3/4"	5000	35	44
-16	1"	4600	32	44
-20	1-1/4"	4000	28	68
-24	1-1/2"	3000	21	111
-32	2"	3000	21	111
-40	2-1/2"	2500	17.5	111
-48	3"	2300	16	218
-56	3-1/2"	500	3.5	218
-64	4"	500	3.5	218
-80	5"	500	3.5	218

NOTE: Connection type opposite 4-bolt flange connection can de-rate maximum working pressure.

#### Code 62 SAE J518-2 / ISO6162-2

Dash Size	Size	Maximum Working Pressure		Fastener Torque Value Grade 8 UNC (ft. lbs.)
		PSI	MPa	
-8	1/2"	6000	40	24
-12	3/4"	6000	40	44
-16	1"	6000	40	68
-20	1-1/4"	6000	40	111
-24	1-1/2"	6000	40	218
-32	2"	6000	40	332
-40	2-1/2"	6000	40	380
-48	3"	6000	40	667

NOTE: For flange dimensions, diagrams and additional information please reference dixonvalve.com.

**Code 61 / Code 62 Split Flange Kits**

**Features**

- For tube, hose end, and split flange adapter connections
- Kits include (2) split flange halves, (4) hex head screws and lockwashers, (1) nitrile rubber O-ring
- Silver trivalent finish for high corrosion resistance
- Also available in forged 316L stainless; contact Dixon® for more information



Flange Size	Code 61 Forged Carbon Steel Part #	Code 62 Forged Carbon Steel Part #
1/2"	C6108-SFKIT	C6208-SFKIT
3/4"	C6112-SFKIT	C6212-SFKIT
1"	C6116-SFKIT	C6216-SFKIT
1-1/4"	C6120-SFKIT	C6220-SFKIT
1-1/2"	C6124-SFKIT	C6224-SFKIT
2"	C6132-SFKIT	C6232-SFKIT
2-1/2"	C6140-SFKIT	---
3"	C6148-SFKIT	---

**Code 61 / Code 62 Flange Adapters**  
Straight Flange x Male JIC Hydraulic Adapter

JIC Thread	Tube O.D.	Flange Size	Code 61 Carbon Steel Part #	Code 62 Carbon Steel Part #
3/4"-16	1/2"	1/2"	C6100F0808	---
		3/4"	C6100F0812	---
1-1/16"-12	3/4"	3/4"	C6100F1212	C6200F1212
		1"	C6100F1216	C6200F1216
1-5/16"-12	1"	3/4"	C6100F1612	C6200F1612
		1"	C6100F1616	C6200F1616
		1-1/4"	C6100F1620	C6200F1620
1-5/8"-12	1-1/4"	1"	C6100F2016	C6200F2016
		1-1/4"	C6100F2020	C6200F2020
		1-1/2"	C6100F2024	C6200F2024
1-7/8"-12	1-1/2"	1-1/4"	C6100F2420	C6200F2420
		1-1/2"	C6100F2424	C6200F2424
		2"	C6100F2432	C6200F2432
2-1/2"-12	2"	1 1/2"	C6100F3224	C6200F3224
		2"	C6100F3232	C6200F3232



**90° Flange Elbow x Male JIC Hydraulic Adapter**

JIC Thread	Tube O.D.	Flange Size	Code 61 Carbon Steel Part #	Code 62 Carbon Steel Part #
3/4"-16	1/2"	3/4"	C6190F0812	---
1-1/16"-12	3/4"	3/4"	C6190F1212	C6290F1212
		1"	C6190F1216	C6290F1216
1-5/16"-12	1"	3/4"	C6190F1612	C6290F1612
		1"	C6190F1616	C6290F1616
		1-1/4"	C6190F1620	C6290F1620
1-5/8"-12	1-1/4"	1"	C6190F2016	C6290F2016
		1-1/4"	C6190F2020	C6290F2020
		1-1/2"	C6190F2024	C6290F2024
1-7/8"-12	1-1/2"	1-1/2"	C6190F2424	C6290F2424
		2"	C6190F2432	C6290F2432
2-1/2"-12	2"	1-1/2"	C6190F3224	C6290F3224
		2"	C6190F3232	C6290F3232



**45° Flange Elbow x Male JIC Hydraulic Adapter**

JIC Thread	Tube O.D.	Flange Size	Code 61 Carbon Steel Part #	Code 62 Carbon Steel Part #
1-1/16"-12	3/4"	3/4"	C6145F1212	C6245F1212
1-5/16"-12	1"	1"	C6145F1616	C6245F1616
1-5/8"-12	1-1/4"	1-1/4"	C6145F2020	C6245F2020
1-7/8"-12	1-1/2"	1-1/2"	C6145F2424	C6245F2424
2-1/2"-12	2"	2"	C6145F3232	C6245F3232





## Hydraulic Suction and Return Line Hose Couplings

### Application

- Designed for hydraulic suction line applications using SAE100R4 hydraulic hose

### Feature

- Barbs provide easy assembly and maximum gripping action

### Female SAE Stem

Hose I.D.	Male NPTF	Plated Steel Part #
3/4"	3/4"-14	188-12
1"	1"-11-1/2	188-16
1-1/4"	1-1/4"-11-1/2	188-20
1-1/2"	1-1/2"-11-1/2	188-24
2"	2"-11-1/2	188-32



### Female SAE 37° Swivel Stem

Hose I.D.	Male NPTF	Plated Steel Part #
3/4"	1-1/16"-12	688-12
1"	1-5/16"-12	688-16
1-1/4"	1-5/8"-12	688-20
1-1/2"	1-7/8"-12	688-24
2"	2-1/2"-12	688-32



NOTE: Return line clamps must be used with these fittings

## Double Bolt Clamps

### Features

- Inner surface has dual gripping ridges
- Bolt lugs are reinforced to prevent bending out of alignment
- Torque values for clamps are based on dry bolts
- The use of lubricant on bolts will adversely effect clamp performance
- Measure hose O.D. accurately before ordering clamps
- Consult Dixon® when using double bolt clamps on helical wire hose



Hose O.D.		Plated Iron Part #	Torque in ft. lbs.	Optional Qty
from	to			
1-8/64"	1-12/64"	J48	15	100
1-40/64"	1-52/64"	DL14	40	25
1-48/64"	2-3/64"	DL20	27	25
2-7/64"	2-19/64"	DL24 <sup>1</sup>	27	25
2-20/64"	2-40/64"	DL32 <sup>1</sup>	40	25

<sup>1</sup> Investment cast carbon steel



## Hydraulic Hose Stems

### Features

- Stems have a collar behind the hex to engage clamp fingers
- Reference clamps on page 161



NPTF Size	Plated Steel Part #
1/2"	HY4
1"	HY8



NPTF Size	Plated Steel Part #
1-1/4"	HY10
1-1/2"	HY12
2"	HY16

## Hydraulic Hose Clamps For 1-Wire Hose

### Application

- For use only on 1-wire hydraulic hoses



Hose I.D.	Hose O.D.		Plated Iron Part #	Torque in ft. lbs.
	from	to		
3/8"	48/64"	50/64"	HD1-3	12
1/2"	56/64"	60/64"	HD1-4	18
3/4"	1-10/64"	1-14/64"	HD1-6	18
1"	1-29/64"	1-35/64"	HD1-8	36

## Hydraulic Hose Clamps For 1- or 2-Wire Hose

### Application

- For use only on 1- or 2-wire hydraulic hoses

### Feature

- This clamp should not be used on 4- or 6-wire hydraulic hose even when hose falls within recommended ranges 



Hose I.D.	Hose O.D.		Plated Iron Part #	Torque in ft. lbs.
	from	to		
3/8"	50/64"	52/64"	HRC-037	18
1/2"	57/64"	1"	HRC-050	18
3/4"	1-16/64"	1-20/64"	HRC-075	36
1"	1-37/64"	1-41/64"	HRC-100	64
1-1/4"	1-54/64"	1-62/64"	HRC-125	90
1-1/2"	2-10/64"	2-18/64"	HRC-150	90
2"	2-43/64"	2-52/64"	HRC-200	90

## Inline Hydraulic Filters

### Features

- Provides protection for small, high pressure systems
- Installs at the pressure side of a pump
- Conically shaped bronze element positioned by a retaining spring to allow true, uninterrupted flow
- Standard 25 micron bronze element can be easily cleaned or replaced

### Specifications

- Temperature range: 35°F to 200°F (2°C to 93°C)
- Maximum operating pressure: 3000 PSI



Female SAE	Overall Length	Diameter	Plated Steel Part #
9/16" - 18	3-1/4"	1-1/2"	9152
3/4" - 16	3-1/4"	1-1/2"	9153

## Pipe and Tube Clamps

### Application

- Standard hydraulic applications, general pipe construction, electric cables, etc.

### Features

- Clamps are welded in place to secure the pipe or tubing
- Polypropylene cushions reduce wear due to vibration
- Kit includes clamp with weld plate, cover plate, and bolts

### Specifications

- Standard and twin series clamps are recommended for systems with less than **1500 PSI** without dynamic loads
- Heavy duty clamps are recommended for systems with greater than **1500 PSI** operating pressure

### Standard Series

Pipe Nom. Bore/Tube O.D.	Length	Width	Height	Steel & Polypropylene Part #
1/8" pipe	1.65"	1.18"	1.30"	HST02P
1/4" pipe	1.89"	1.18"	1.54"	HST04P
1/4" tube	1.65"	1.18"	1.30"	HST04T
5/16" tube	1.65"	1.18"	1.30"	HST05T
3/8" pipe	1.89"	1.18"	1.54"	HST06P
3/8" tube	1.65"	1.18"	1.30"	HST06T
1/2" pipe	2.17"	1.18"	1.61"	HST08P
1/2" tube	1.89"	1.18"	1.54"	HST08T
5/8" tube	1.89"	1.18"	1.54"	HST10T
3/4" pipe	2.44"	1.18"	1.89"	HST12P
3/4" tube	2.17"	1.18"	1.61"	HST12T
7/8" tube	2.17"	1.18"	1.61"	HST14T
1" pipe	2.91"	1.18"	2.52"	HST16P
1" tube	2.17"	1.18"	1.61"	HST16T
1-1/4" pipe	2.91"	1.18"	2.52"	HST20P
1-1/4" tube	2.91"	1.18"	2.52"	HST20T
1-1/2" pipe	3.46"	1.18"	2.83"	HST24P
1-1/2" tube	2.91"	1.18"	2.52"	HST24T
2" tube	3.46"	1.18"	2.83"	HST32T



K

### Twin Series

Pipe Nom. Bore/Tube O.D.	Length	Width	Height	Steel & Polypropylene Part #
1/8" pipe	1.46"	1.18"	1.36"	HTW02P
1/4" pipe	1.46"	1.18"	1.36"	HTW04P
1/4" tube	1.46"	1.18"	1.36"	HTW04T
5/16" tube	1.46"	1.18"	1.36"	HTW05T
3/8" pipe	2.17"	1.18"	1.42"	HTW06P
3/8" tube	1.46"	1.18"	1.36"	HTW06T
1/2" pipe	2.76"	1.18"	1.85"	HTW08P
1/2" tube	2.17"	1.18"	1.42"	HTW08T
5/8" tube	2.17"	1.18"	1.42"	HTW10T
3/4" pipe	3.35"	1.18"	2.05"	HTW12P
3/4" tube	2.76"	1.18"	1.85"	HTW12T
7/8" tube	2.76"	1.18"	1.85"	HTW14T
1" pipe	4.33"	1.18"	2.52"	HTW16P
1" tube	2.76"	1.18"	1.85"	HTW16T
1-1/4" pipe	4.33"	1.18"	2.52"	HTW20P
1-1/4" tube	4.33"	1.18"	2.52"	HTW20T
1-1/2" tube	4.33"	1.18"	2.52"	HTW24T



Pipe and Tube Clamps

Heavy Duty Series



Pipe Nom. Bore/Tube O.D.	Length	Width	Height	Steel & Polypropylene Part #
1/8" pipe	2.87"	1.18"	1.89"	HHD02P
1/4" pipe	2.87"	1.18"	1.89"	HHD04P
1/4" tube	2.87"	1.18"	1.89"	HHD04T
5/16" tube	2.87"	1.18"	1.89"	HHD05T
3/8" pipe	2.87"	1.18"	1.89"	HHD06P
3/8" tube	2.87"	1.18"	1.89"	HHD06T
1/2" pipe	3.35"	1.18"	2.52"	HHD08P
1/2" tube	2.87"	1.18"	1.89"	HHD08T
5/8" tube	2.87"	1.18"	1.89"	HHD10T
3/4" pipe	3.35"	1.18"	2.52"	HHD12P
3/4" tube	3.35"	1.18"	2.52"	HHD12T
7/8" tube	3.35"	1.18"	2.52"	HHD14T
1" pipe	3.94"	1.18"	2.99"	HHD16P
1" tube	3.35"	1.18"	2.52"	HHD16T
1-1/4" pipe	5.51"	1.77"	4.33"	HHD20P
1-1/4" tube	3.94"	1.18"	2.99"	HHD20T
1-1/2" pipe	5.51"	1.77"	4.33"	HHD24P
1-1/2" tube	3.94"	1.18"	2.99"	HHD24T
2" pipe	5.51"	1.77"	4.33"	HHD32P
2" tube	5.51"	1.77"	4.33"	HHD32T

**Holedall .....572 - 593**

- Coupling machines .....572
- Recommended working pressures .....573
- External swage ..... 574 - 579
  - Stems ..... 575 - 576
  - Flange assemblies .....576
  - Female ends .....577
  - Uni-range male couplings .....577
  - Ferrules ..... 578 - 579
  - High pressure couplings .....579
- Internal expansion ..... 580 - 581
  - Stems ..... 580 - 581
  - Ferrules .....581
- Holedall Petroleum style..... 582 - 583
  - Couplings .....582
  - Ferrules .....583
- API Certified Holedall Petroleum attached..... 584 - 585
  - Couplings .....584
  - Ferrules .....585
- Washers .....586
- HB coupling expander machine .....586
- Pump hose couplings .....586
- Dubl-Grip field attachable couplings.....587
- CIP internal expansion sanitary style .....588
- Sanitary style..... 588 - 590
  - Stems ..... 588 - 589
  - Threaded hex nuts.....589
  - Flow Chief ferrules .....590
- Sanitary King Crimp® stems .....591
- DIN external crimp stems .....591
- Dixon Sanitary crimp stems .....592
- Dixon Sanitary crimp ferrules .....593



## Holedall Coupling Machines

Rams are powerful, finely engineered machines designed specifically to externally swage and internally expand Holedall couplings by hydraulic pressure, securely attaching Holedall couplings to hose. Since each ram generates all the hydraulic pressure required to attach the Holedall coupling, one person can easily operate the equipment.

**15 Ton Ram**



**Application**

- For internally expanded couplings only

**Features**

- Can expand 1" through 3" steel fittings and 5/8" through 4" brass Holedall petroleum fittings
- Bench-mounted model (optional stand available)

**Specifications**

- Produces up to **10,000 PSI**, for up to 15 tons of ram force
- Motor: 1/2 h.p., 115 volt, 60 cycle, single phase with foot pedal

**100 Ton Ram**



**Application**

- For externally swaging Holedall fittings to hose, sizes 1-1/4" through 10" I.D.

**Feature**

- Optional accessories allow the ram to be used for internally expanded couplings on hose from 1" through 6"

**Specifications**

- Capable of producing up to 100 tons of ram force
- Motor: 1-1/8 h.p., 115 volt, 60 cycle, single phase motor is standard with remote (220/440 volt motors are available)

**25 Ton Ram**



**Features**

- Freestanding model
- High-speed pump kit option is available

**Specifications**

- Can externally swage 1/4" through 4" I.D. hose and internally expand 5/8" through 4" I.D. hose with proper equipment
- Produces up to **10,000 PSI** of line pressure for up to 25 tons of ram force
- Motor is 1/2 h.p., 115 volt 60 cycle, single phase with foot pedal

**350 Ton Ram**

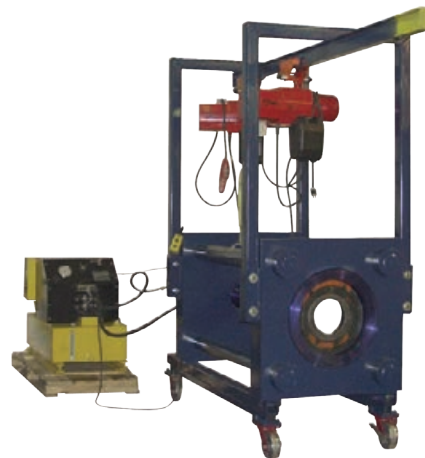

**Application**

- For externally swaging Holedall and rotary fittings

**Features**

- 14" 150 lb. flange will fit through the bed plate
- Ram has 36" of stroke
- Motor: 12-1/2 h.p., 230 volt, 60Hz, 3-phase motor is standard with remote

**Specification**

- Produces up to 354 tons of ram force for swaging

**50 Ton Ram**



**Features**

- Can externally swage 1-1/4" through 6" I.D. hose and internally expand 1" through 6" I.D. hose with proper equipment
- Bench-mounted model (optional stand available)

**Specifications**

- Produces up to **10,000 PSI**, for up to 50 tons of ram force
- Motor is 1-1/8 h.p., 115 volt, 60 cycle, single phase, standard with remote (220/440 volt motors are available)

**!** All rams require dies of the proper size to reduce the ferrule to the proper diameter for a good grip on the hose. Pushers of the proper size must be used on the end of the ram to push the Holedall fitting through the die. Die and pusher selection depends on the sizes and types of hoses being coupled. Ferrule recommendations are available upon request. Consult Dixon® for specific details.

### Recommended Working Pressures

**⚠ WARNING** Holedall couplings, regardless of coupling style, are never to be used for steam service at any pressure. Holedall fittings listed below are not to be used with cable reinforced high-pressure hose, 4- or 6-braid wire hydraulic hose or any other service not listed in recommendations. In addition, internally expanded Holedall couplings are not to be used with plastic-lined chemical hose. Consult Dixon® for recommendations on usage.

Holedall couplings (externally swaged), to perform satisfactorily, must be applied properly in accordance with Dixon assembly procedures, using the correct die and ferrule for that particular hose end O.D.. The Dixon die and ferrule recommendation guide is to be used to select correct dies and ferrules. If you do not have the updated die and ferrule recommendation guide, consult Dixon. Strict adherence to ferrule O.D. range (internally expanded) for each hose end to be assembled is essential for satisfactory performance.

Note: Hose service working pressure (including surges and spikes) is never to exceed the maximum recommended working pressure for the fitting (reference chart below)<sup>2</sup>. Media being transported through the hose should be compatible with the stem material. Compatibility of ferrule material with the environment in which it will be used is recommended. Consult the Compatibility Chart on [dixonvalve.com](http://dixonvalve.com) or contact Dixon for material compatibility. For applications other than the ones listed, please consult Dixon.

Size	Externally Swaged				Internally Expanded			
	Standard Fittings <sup>1</sup>	Long Style Fittings <sup>1</sup>	Light Duty Fittings		Cam and Groove <sup>1</sup>	Holedall DIN Crimp Stems <sup>1</sup>	Internally Expanded <sup>1</sup>	Flow Chief / Crimp Sanitary Fittings <sup>1</sup>
			NO Notched Fittings <sup>1</sup>	NOS Notched Short Fittings <sup>1</sup>				
TM, TP, TG, TMR, TPR, TGR	TML, TPL, TGL	TM, TP, TG, RN***NO	RST***NOS, STC***NOS, GAS***NOS					
3/4"	---	---	---	---	---	---	---	---
1"	---	---	---	---	250	---	---	---
1-1/4"	600	1,000	350	---	---	---	800	---
1-3/8"	---	---	---	---	---	---	---	---
1-1/2"	600	1,000	350	250	250	145	800	250
2"	600	1,000	350	250	250	145	800	250
2-1/2"	600	1,000	250	---	150	---	600	250
3"	600	1,000	250	250	125	145	600 <sup>3</sup>	250
4"	500	850	250	<sup>4</sup>	100	---	500 <sup>3</sup>	200
5"	450	750	---	---	---	---	---	---
6"	400	700	---	---	---	---	400	---
8"	350	600	---	---	---	---	---	---
10"	300	550	---	---	---	---	---	---

- <sup>1</sup> Maximum recommended working pressures, in **PSI**, given at **70°F** ambient temperature
- <sup>2</sup> The assembly's (hose + coupling) maximum working pressure is the lesser of:
  - 1) The hose rated working pressure, or
  - 2) The coupling rated working pressure
- <sup>3</sup> For hoses which use IXF48-3 to IXF48-5 and IXF64-2 to IXF64-5, consult Dixon for working pressures. See notes below for specific recommendations
- <sup>4</sup> Contact Dixon for pressure recommendations

#### Standard Fittings

Recommended for use on most 1- and 2-wire braid reinforced hoses, fiber reinforced (braided or spiraled) with or without helical wire such as: oil suction and discharge hose, barge and dock loading and unloading hose, as well as LP gas hose, anhydrous ammonia hose, acid chemical hose, and high pressure air and water hose.

#### Long Style Fittings

Recommended for use on hose as listed under standard fittings where additional retention is required due to higher working pressures or end pull. Consult maximum working pressure chart or call Dixon.

#### Light-Duty Fittings

Recommended for use in the same applications as standard fittings above where lower working pressures are encountered. Consult maximum working pressure chart or consult Dixon.

#### Internally Expanded Fittings

Recommended for concrete placement, grout and plaster, food, dairy, pharmaceutical as well as other applications where increased flow capacity is important. Consult maximum working pressure chart or call Dixon for additional application and working pressure information.

## Holedall External Swage Coupling System

The Holedall coupling system provides outstanding strength, durability, and safety.

The Holedall system is a method of attaching couplings to hose utilizing a progressive swage. The patented Holedall couplings include a Holedall stem and a specially engineered ferrule. The hydraulic swaging of the coupling to the hose is accomplished by pushing the ferrule through a die which reduces the ferrule O.D., thus providing a 360° uninterrupted compression band around the hose.

A hydraulic ram is the only piece of machinery necessary to accomplish the coupling. Available in five different sizes - 15, 25, 50, 100, and 350 ton see page 572 - these rams will accommodate dies and pushers of various sizes so that hoses up to 10" in diameter may be coupled.

This multi-purpose, high pressure coupling system requires no bolts and results in a clean coupling with no protrusions. The swaging operation is fast and hose of various lengths and different styles can be coupled. Ease of operation, flexibility and economy make the Holedall method an unequalled assembly system.

### Features

- Provides long-lasting efficiency and safety
- Lightweight coupling consisting of ferrule and stem
- Streamlined, no protrusions to snag on equipment
- Available in stainless steel and carbon steel
- Available in multiple configurations: pipe thread, plain end, grooved, or flanged ends

Holedall stems and ferrules are specifically designed to be used together as a coupling system. Due to differences in dimensions and tolerances, for safety reasons, do not use other manufacturers' stems or ferrules with Holedall products. 

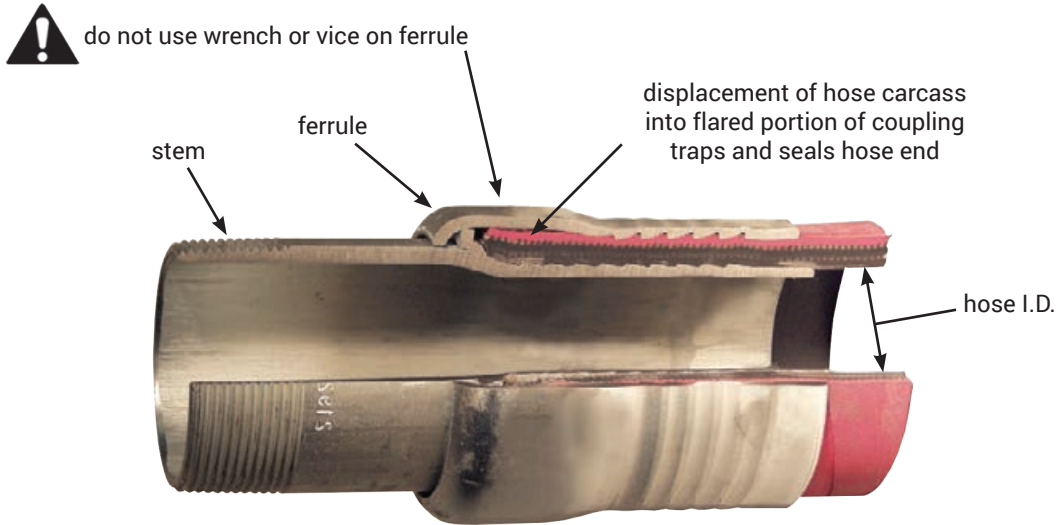

cross-section of Holedall externally swaged assembly



## External Swage Stems

### Male NPT End Tubular Type

#### Features

- Designed for hose I.D.s 1-1/4" - 10"; ferrule size depends on the hose O.D.. Refer to page 578 to select the correct ferrule
- For higher working pressure applications use long style stems and ferrules

Hose I.D.	Plated Carbon Steel Part #	316 Stainless Part #	Long Style Carbon Steel Part #
1-1/4"	TM20	TMR20	TML20
1-1/2"	TM24	TMR24	TML24
2"	TM32	TMR32	TML32
2-1/2"	TM40	TMR40	TML40
3"	TM48	TMR48	TML48
4"	TM64	TMR64	TML64
	---	TMR64-42	---
5"	TM80	---	TML80
6"	TM96	TMR96	TML96
	---	TMR96-42	---
8"	TM128	---	TML128
10"	TM160	---	---



### Beveled End for Welding

Hose I.D.	Unplated Carbon Steel Part #	316 Stainless Steel Part #	Long Style Unplated Carbon Steel Part #
1-1/4"	TP20	---	TPL20
1-1/2"	TP24	---	TPL24
2"	TP32	TPR32	TPL32
2-1/2"	TP40	---	TPL40
3"	TP48	TPR48	TPL48
4"	TP64	TPR64	TPL64
	TP64-42	---	TPL64-42
5"	TP80	---	TPL80
6"	TP96	---	TPL96
8"	TP128	---	TPL128
10"	TP160	---	TPL160



L

### Grooved End

Hose I.D.	Plated Carbon Steel Part #	316 Stainless Part #	Long Style Plated Carbon Steel Part #
1-1/4"	TG20	---	TGL20
1-1/2"	TG24	TGR24	TGL24
2"	TG32	TGR32	TGL32
2-1/2"	TG40	TGR40	TGL40
3"	TG48	TGR48	TGL48
4"	TG64	TGR64	TGL64
	TG64-42	---	TGL64-42
5"	TG80	---	TGL80
6"	TG96	---	TGL96
8"	TG128	---	TGL128
10"	TG160	---	TGL160



**Special Holedall Stems**



Hose I.D.	Material	Thread	Part #
4"	carbon steel	NPT	TM64-42
	carbon steel		TML64-42
6"	unplated carbon steel	NPT	TM96-42
	316 stainless		TMR96-42
	carbon steel		TML96-42
	unplated carbon steel	beveled	TP96-42
	316 stainless		TPR96-42
	carbon steel	grooved	TGL96-42
	carbon steel		TG96-42
8"	unplated carbon steel	NPT	TM128-42
	carbon steel	beveled	TP128-42
	carbon steel	grooved	TG128-42

NOTE: Use with external swage ferrules on page 578

**External Swage  
Flange Assemblies**

**Features**

- 150# ASA flange drilling available with carbon steel stem, flange, and ferrule, or with 316 stainless steel stem and flange and carbon steel ferrule
- Available in other sizes; consult Dixon®

**Fixed Flange**

Hose I.D.	Hose O.D.		Carbon Steel Part #	Stainless Steel Part #
	From	To		
2"	2-28/64"	2-40/64"	32P1S015	R32P1SOR15
	2-41/64"	2-48/64"	32P2S015	R32P2SOR15
	2-49/64"	2-56/64"	32P3S015	R32P3SOR15
3"	3-30/64"	3-40/64"	48P1S015	R48P1SOR15
	3-41/64"	3-48/64"	48P2S015	R48P2SOR15
	3-49/64"	3-56/64"	48P3S015	R48P3SOR15
4"	4-40/64"	4-44/64"	64P1S015	R64P1SOR15
	4-45/64"	4-52/64"	64P2S015	R64P2SOR15
	4-53/64"	4-60/64"	64P3S015	R64P3SOR15
6"	7"	7-4/64"	96P1S015	R96P1SOR15
	7-5/64"	7-12/64"	96P2S015	R96P2SOR15
	7-13/64"	7-20/64"	96P3S015	R96P3SOR15
8"	9-20/64"	9-24/64"	128P1S015	---
	9-25/64"	9-32/64"	128P2S015	---
	9-33/64"	9-40/64"	128P3S015	---

**Floating Flange**

Hose I.D.	Hose O.D.		Carbon Steel Part #	Stainless Steel Part #
	From	To		
2"	2-28/64"	2-40/64"	32P1LJ15	R32P1LJR15
	2-41/64"	2-48/64"	32P2LJ15	R32P2LJR15
	2-49/64"	2-56/64"	32P3LJ15	R32P3LJR15
3"	3-30/64"	3-40/64"	48P1LJ15	R48P1LJR15
	3-41/64"	3-48/64"	48P2LJ15	R48P2LJR15
	3-49/64"	3-56/64"	48P3LJ15	R48P3LJR15
4"	4-40/64"	4-44/64"	64P1LJ15	R64P1LJR15
	4-45/64"	4-52/64"	64P2LJ15	R64P2LJR15
	4-53/64"	4-60/64"	64P3LJ15	R64P3LJR15
6"	7"	7-4/64"	96P1LJ15	R96P1LJR15
	7-5/64"	7-12/64"	96P2LJ15	R96P2LJR15
	7-13/64"	7-20/64"	96P3LJ15	R96P3LJR15
8"	9-20/64"	9-24/64"	128P1LJ15	---
	9-25/64"	9-32/64"	128P2LJ15	---
	9-33/64"	9-40/64"	128P3LJ15	---

NOTE: For flange dimensions, diagrams and additional information, please reference [dixonvalve.com](http://dixonvalve.com).

### External Swage Stems - Female End

Size	Hose O.D.		Plated Carbon Steel Part #
	from	to	
1"	1-30/64"	1-34/64"	TF16WF1-80
	1-34/64"	1-38/64"	TF16WF2-80
	1-35/64"	1-42/64"	TF16WF3-80
1-1/4"	1-44/64"	1-48/64"	---
	1-49/64"	1-56/64"	TF20WF2-80 <sup>1</sup>
	1-57/64"	2"	TF20WF3-80 <sup>1</sup>
2"	2-36/64"	2-40/64"	TF32WF1-80 <sup>1</sup>
	2-41/64"	2-48/64"	TF32WF2-80 <sup>1</sup>
	2-49/64"	2-56/64"	TF32WF3-80 <sup>1</sup>



two piece design  
1"



one piece design  
1-1/4" - 2"

<sup>1</sup> Special pusher required for 1-1/4" and 2" sizes: 1-1/4" 25PUSH125-MOD, 2" 25PUSH200MOD

### External Swage Uni-Range Male Couplings

#### Applications

- Recommended for use on most 1- or 2-wire braid reinforced hoses, fiber reinforced (braided or spiral) with or without helical wire such as chemical, high pressure air and water hoses, and LP gas hoses

#### Features

- Designed for smaller hose systems, hose I.D.s of 1/4" - 1"
- Shipped complete with factory assembled stem and ferrule combination
- Can be swaged or crimped
- Stainless steel stems are investment cast
- Other hose O.D.s available; consult Dixon®

Hose I.D.	Hose I.D.		Plated Carbon Steel Part #	Stainless / Carbon Steel Part #	Stainless Steel Part #
	From	To			
1/4"	34/64"	38/64"	4P1	---	---
	38/64"	42/64"	4P2	---	---
	42/64"	46/64"	4P3	---	---
3/8"	46/64"	50/64"	6P1	---	---
	50/64"	54/64"	6P2	---	---
	54/64"	58/64"	6P3	---	---
1/2"	54/64"	58/64"	8P1	---	---
	58/64"	62/64"	8P2	---	R8P2SS
	62/64"	1-2/64"	8P3	---	---
3/4"	1-6/64"	1-12/64"	---	---	R12P1250
	1-10/64"	1-14/64"	12P1	R12P1	---
	1-13/64"	1-22/64"	---	---	R12P1370
	1-14/64"	1-18/64"	12P2	R12P2	---
	1-18/64"	1-22/64"	12P3	R12P3	---
1"	1-30/64"	1-34/64"	16P1	R16P1	---
	1-30/64"	1-38/64"	---	---	R16P1620
	1-34/64"	1-38/64"	16P2	R16P2	---
	1-38/64"	1-42/64"	16P3	R16P3	---
	1-38/64"	1-46/64"	---	---	R16P1770
	1-42/64"	1-46/64"	16P4	R16P4	---



### External Swage Ferrules

The selection of ferrules is very important to achieve the proper coupling-to-hose assembly. For assistance in proper selection, contact Dixon®.

**Features**

- Style F ferrules are used with all standard length stems, page 575
- Style FL ferrules are extra long and are used with all long style stems, page 575

**Material**

- Plated carbon steel



long style

Size	Hose O.D.		Plated Carbon Steel	Plated Carbon Steel
	From	To	Part #	Long Style Part #
1-1/4"	1-44/64"	1-48/64"	F20-1	FL20-1
	1-49/64"	1-56/64"	F20-2	FL20-2
	1-57/64"	2"	F20-3	FL20-3
	2-1/64"	2-8/64"	F20-4	FL20-4
1-1/2"	1-58/64"	2"	F24-1	FL24-1
	2-1/64"	2-8/64"	F24-2	FL24-2
	2-9/64"	2-16/64"	F24-3	FL24-3
	2-17/64"	2-24/64"	F24-4	FL24-4
	2-25/64"	2-32/64"	F24-5	FL24-5
2"	2-28/64"	2-40/64"	F32-1	FL32-1
	2-41/64"	2-48/64"	F32-2	FL32-2
	2-49/64"	2-56/64"	F32-3	FL32-3
	2-57/64"	3-2/64"	F32-4	FL32-4
2-1/2"	2-62/64"	3-8/64"	F40-1	FL40-1
	3-9/64"	3-16/64"	F40-2	FL40-2
	3-17/64"	3-24/64"	F40-3	FL40-3
	3-25/64"	3-32/64"	F40-4	FL40-4
	3-33/64"	3-40/64"	F40-5	FL40-5
3"	3-30/64"	3-40/64"	F48-1	FL48-1
	3-41/64"	3-48/64"	F48-2	FL48-2
	3-49/64"	3-56/64"	F48-3	FL48-3
	3-57/64"	4"	F48-4	FL48-4
	4-1/64"	4-8/64"	F48-5	FL48-5
4"	4-30/64"	4-39/64"	F64-Z <sup>1</sup>	FL64-Z <sup>1</sup>
	4-40/64"	4-44/64"	F64-1	FL64-1
	4-45/64"	4-52/64"	F64-2	FL64-2
	4-53/64"	4-60/64"	F64-3	FL64-3
	4-61/64"	5-4/64"	F64-4	FL64-4
	5-5/64"	5-12/64"	F64-5	FL64-5
	5-13/64"	5-20/64"	F64-6	FL64-6
	5-21/64"	5-28/64"	F64-7	FL64-7
	5-29/64"	5-36/64"	F64-8	FL64-8
	5-56/64"	5-60/64"	F80-1	FL80-1
5"	5-61/64"	6-4/64"	F80-2	FL80-2
	6-5/64"	6-12/64"	F80-3	FL80-3
	6-13/64"	6-20/64"	F80-4	FL80-4
	6-21/64"	6-28/64"	F80-5	FL80-5
	6-29/64"	6-38/64"	F80-6	FL80-6
	6-37/64"	6-44/64"	F80-7	FL80-7
	6-44/64"	6-63/64"	F96-Z <sup>1</sup>	FL96-Z <sup>1</sup>
6"	7"	7-4/64"	F96-1	FL96-1
	7-5/64"	7-12/64"	F96-2	FL96-2
	7-13/64"	7-20/64"	F96-3	FL96-3
	7-21/64"	7-28/64"	F96-4	FL96-4
	7-29/64"	7-36/64"	F96-5	FL96-5
	7-37/64"	7-44/64"	F96-6	FL96-6
	7-45/64"	7-52/64"	F96-7	FL96-7
	7-53/64"	7-60/64"	F96-8	FL96-8
	7-61/64"	8"	F96-9	FL96-9
8"	8-53/64"	8-56/64"	F128-X <sup>1</sup>	---
	9"	9-9/64"	F128-Y	FL128-Y
	9-20/64"	9-24/64"	F128-1	FL128-1
	9-25/64"	9-32/64"	F128-2	FL128-2
	9-33/64"	9-40/64"	F128-3	FL128-3
	9-41/64"	9-48/64"	F128-4	FL128-4
	9-49/64"	9-56/64"	F128-5	FL128-5
	9-57/64"	10"	F128-6	FL128-6
10"	10-1/64"	10-4/64"	F128-7	FL128-7
	11-32/64"	11-44/64"	F160-1	FL160-1
	11-45/64"	11-60/64"	F160-2	FL160-2
	11-61/64"	12-12/64"	F160-3	FL160-3
	12-13/64"	12-28/64"	F160-4	FL160-4
	12-29/64"	12-44/64"	F160-5	FL160-5
	12-45/64"	12-60/64"	F160-6	FL160-6

<sup>1</sup> Requires use with special stems on page 576

NOTE: For applications with hose O.D. ranges not listed, contact Dixon®

## External Swage Ferrules - Light Duty

### Application

- For use with standard length stems styles TMR, TPR, and TGR series on pages 575 - 576

### Feature

- Consult Dixon® for die recommendations, go to [dixonvalve.com](http://dixonvalve.com) for specific pressure recommendations

Hose I.D.	Hose O.D.		304 Stainless Steel Part #
	From	To	
1-1/2"	1-60/64"	2-12/64"	GAS2334TO
	2-4/64"	2-22/64"	GAS2370TO
2"	2-30/64"	2-44/64"	GAS2709TO
	2-42/64"	2-54/64"	GAS2885TO
3"	3-30/64"	3-46/64"	GAS3760TO
	3-47/64"	3-54/64"	GAS3885TO
4"	4-40/64"	4-47/64"	GAS5010TO



## External Swage High Pressure Couplings

### Features

- Sold as a complete coupling (stem and matching ferrule)
- Must provide hose O.D. when ordering for a properly sized ferrule; make sure both ends of the hose are measured for O.D.
- Must be swaged with 50 ton or 100 ton ram
- API and NPT sizes are interchangeable
- Stems are machined from seamless pipe and tubing with specially designed serrations
- Ferrules are machined from a heavy wall material incorporating matching serrations

### Specification

- Intended for services requiring a fitting to withstand extremely high pressures (up to **3,000 PSI at 70°F (21°C)**) and severe operating conditions including: small and medium size drilling rigs, slim hole applications and core drill, workover, seismograph, water well, blast or shot holes

### Stem and Ferrule Complete Assemblies

- An accurate hose O.D. must be provided to complete the part # and to ensure proper retention

#### Male NPT Thread Coupling Units

Hose I.D.	NPT Size	Zinc Plated Steel Part #
2"	2"	LM32-*
2-1/2"	2-1/2"	LM40-*
3"	3"	LM48-*

#### Male API Thread Coupling Units

Hose I.D.	API Size	Zinc Plated Steel Part #
2"	2-1/2"	LM3240- *
2-1/2"	3"	LM4048- *
3"	4"	LM4864- *



## Internal Expansion Coupling System

### Applications

- Essential in applications requiring maximum flow including: concrete pump hose, plaster and grout hose, oil suction and discharge hose, multi-purpose heavy duty air hose, jetting hose, barge loading hose, and bottom loading hose.

### Features

- Maximum flow of media
- Reduction of turbulence through hose
- Excellent sealing and retention characteristics
- Outperforms band clamps
- Easy and consistent installation
- Only one expansion tool is needed for each hose I.D.
- Available end configurations: male NPT, grooved, others available; contact Dixon®

NOTE: Holedall stems and ferrules are specifically designed to be used together as a coupling system. Due to differences in dimensions and tolerances, for safety reasons, do not use other manufacturers' stems or ferrules with Holedall products.

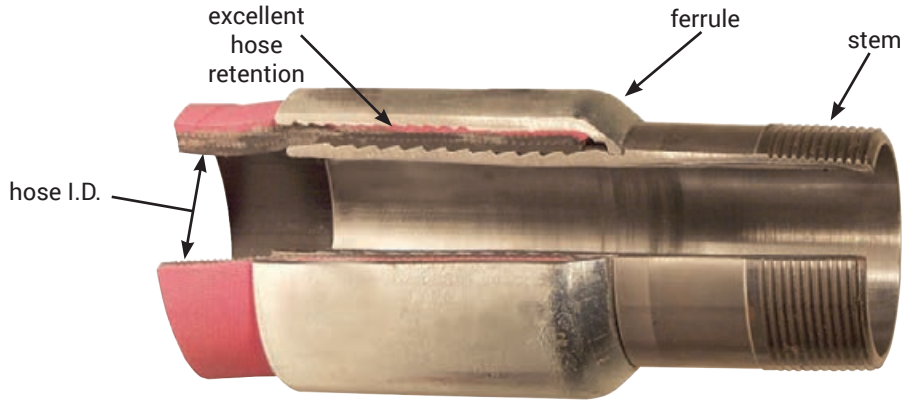

Cross-section of Holedall internally expanded assembly

### Male Pipe Threaded End Stems



Size	Working PSI <sup>1</sup>	Carbon Steel Part #
1"	800	IXM16
1-1/4"	800	IXM20
1-1/2"	800	IXM24
2"	800	IXM32
2-1/2"	600	IXM40
3"	600 <sup>2</sup>	IXM48
4"	500 <sup>2</sup>	IXM64
6"	400	IXM96

<sup>1</sup> Maximum recommended working pressures at 70°F (21°C) ambient temperature

<sup>2</sup> For hoses that use IXF48-3 to IXF48-5 and IXF64-2 to IXF64-5, consult Dixon for working pressures. See page 573 for specific recommendations.

### Heavy Duty Raised End Stems



Size	Working PSI <sup>1</sup>	Carbon Steel Part #
1-1/2"	800	IXH24
2"	800	IXH32
2-1/2"	600	IXH40
3"	600 <sup>2</sup>	IXH48
4"	500 <sup>2</sup>	IXH64

<sup>1</sup> Maximum recommended working pressures at 70°F (21°C) ambient temperature

<sup>2</sup> For hoses that use IXF48-3 to IXF48-5 and IXF64-2 to IXF64-5, consult Dixon for working pressures. See page 573 for specific recommendations.

## Internal Expansion Coupling System Grooved End Stems

Size	Working PSI <sup>1</sup>	Carbon Steel Part #
1-1/4"	800	IXV20
1-1/2"	800	IXV24
2"	800	IXV32
2-1/2"	600	IXV40
3"	600 <sup>2</sup>	IXV48
4"	500 <sup>2</sup>	IXV64

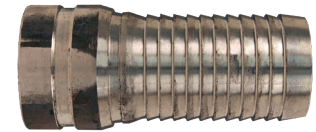

<sup>1</sup> Maximum recommended working pressures at 70°F (21°C) ambient temperature

<sup>2</sup> For hoses that use IXF48-3 to IXF48-5 and IXF64-2 to IXF64-5, consult Dixon® for working pressures. See page 573 for specific recommendations.

## Internal Expansion Ferrules



Hose I.D.	Hose O.D.		Ferrule I.D.	Plated Carbon Steel Part #	Hose I.D.	Hose O.D.		Ferrule I.D.	Plated Carbon Steel Part #
	From	To				From	To		
1"	1-24/64"	1-28/64"	1-7/16"	IXF16-1	3"	3-32/64"	3-36/64"	3-9/16"	IXF48-T
	1-28/64"	1-32/64"	1-1/2"	IXF16-2		3-36/64"	3-40/64"	3-5/8"	IXF48-U
	1-32/64"	1-36/64"	1-9/16"	IXF16-3		3-40/64"	3-44/64"	3-11/16"	IXF48-V
	1-36/64"	1-40/64"	1"	IXF16-4		3-44/64"	3-48/64"	3-3/4"	IXF48-W
1-1/4"	1-40/64"	1-44/64"	1-11/16"	IXF20-Z	4"	3-48/64"	3-52/64"	3-13/16"	IXF48-X
	1-44/64"	1-48/64"	1-3/4"	IXF20-1		3-52/64"	3-56/64"	3-7/8"	IXF48-Y
	1-48/64"	1-52/64"	1-13/16"	IXF20-2		3-56/64"	3-60/64"	3-15/16"	IXF48-Z
	1-52/64"	1-56/64"	1-7/8"	IXF20-3		3-60/64"	4"	4"	IXF48-1
	1-56/64"	1-60/64"	1-15/16"	IXF20-4		4"	4-4/64"	4-1/16"	IXF48-2
	1-60/64"	2"	2"	IXF20-5		4-4/64"	4-8/64"	4-1/8"	IXF48-3 <sup>1</sup>
	2"	2-4/64"	2-1/16"	IXF20-6		4-8/64"	4-12/64"	4-3/16"	IXF48-4 <sup>1</sup>
1-1/2"	1-56/64"	1-60/64"	1-15/16"	IXF24-Z	4"	4-12/64"	4-16/64"	4-1/4"	IXF48-5 <sup>1</sup>
	1-60/64"	2"	2"	IXF24-1		4-36/64"	4-40/64"	4-5/8"	IXF64-T
	2"	2-4/64"	2-1/16"	IXF24-2		4-40/64"	4-44/64"	4-11/16"	IXF64-U
	2-4/64"	2-8/64"	2-1/8"	IXF24-3		4-44/64"	4-48/64"	4-3/4"	IXF64-V
	2-8/64"	2-12/64"	2-3/16"	IXF24-4		4-48/64"	4-52/64"	4-13/16"	IXF64-W
	2-12/64"	2-16/64"	2-1/4"	IXF24-5		4-52/64"	4-56/64"	4-7/8"	IXF64-X
	2-16/64"	2-20/64"	2-5/16"	IXF24-6		4-56/64"	4-60/64"	4-15/16"	IXF64-Y
	2-20/64"	2-24/64"	2-3/8"	IXF24-7		4-60/64"	5"	5"	IXF64-Z
2"	2-32/64"	2-36/64"	2-9/16"	IXF32-Y	5"	5"	5-4/64"	5-1/16"	IXF64-1
	2-36/64"	2-40/64"	2-5/8"	IXF32-Z		5-4/64"	5-8/64"	5-1/8"	IXF64-2 <sup>1</sup>
	2-40/64"	2-44/64"	2-11/16"	IXF32-1		5-8/64"	5-12/64"	5-3/16"	IXF64-3 <sup>1</sup>
	2-44/64"	2-48/64"	2-3/4"	IXF32-2		5-12/64"	5-16/64"	5-1/4"	IXF64-4 <sup>1</sup>
	2-48/64"	2-52/64"	2-13/16"	IXF32-3		5-16/64"	5-20/64"	5-5/16"	IXF64-5 <sup>1</sup>
	2-52/64"	2-56/64"	2-7/8"	IXF32-4		6-40/64"	6-44/64"	6-11/16"	IXF96-1
	2-56/64"	2-60/64"	2-15/16"	IXF32-5		6-44/64"	6-48/64"	6-3/4"	IXF96-2
	2-60/64"	3"	3"	IXF32-6		6-46/64"	6-50/64"	6-25/32"	IXF96-3
	3"	3-4/64"	3-1/16"	IXF32-7		6-48/64"	6-52/64"	6-13/16"	IXF96-4
	3"	3-4/64"	3-1/16"	IXF40-1		6-52/64"	6-56/64"	6-7/8"	IXF96-5
2-1/2"	3-4/64"	3-8/64"	3-1/8"	IXF40-2	6"	6-56/64"	6-60/64"	6-15/16"	IXF96-6
	3-8/64"	3-12/64"	3-3/16"	IXF40-3		6-60/64"	7"	7"	IXF96-7
	3-12/64"	3-16/64"	3-1/4"	IXF40-4		7"	7-4/64"	7-1/16"	IXF96-8
	3-16/64"	3-20/64"	3-5/16"	IXF40-5		7-4/64"	7-8/64"	7-1/8"	IXF96-9
	3-20/64"	3-24/64"	3-3/8"	IXF40-6		7-8/64"	7-12/64"	7-3/16"	IXF96-10
	3-24/64"	3-28/64"	3-7/16"	IXF40-7		7-12/64"	7-16/64"	7-1/4"	IXF96-11
	3-28/64"	3-32/64"	3-1/2"	IXF40-8		7-16/64"	7-20/64"	7-5/16"	IXF96-12
						7-18/64"	7-22/64"	7-11/32"	IXF96-13
				7-20/64"	7-24/64"	7-3/8"	IXF96-14		

<sup>1</sup> For hoses using ferrule sizes IXF48-3 thru IXF48-5 and IXF64-2 thru IXF64-5, consult Dixon for working pressures

NOTE: For use with IX stems on pages 580 - 581

## Holedall Petroleum Style Couplings

### Applications

- Recommended for discharge and suction service; commonly used in the transfer of fuel to homes, airplanes, ships, etc.
- Intended for fuel delivery service, see page 584 for information on API 1529 certification

### Features

- Compact, lightweight, and streamlined to eliminate catching on curbs and shrubs
- Stems and ferrules are designed to be used together as a coupling system
- Stem is expanded to nominal I.D. of hose for a rigid, uniform, full-flow area
- All fittings have octagonal facets for tightening with a wrench; females in 1-1/2" and larger sizes have lugs for tightening
- Pre-lubricated for assembly
- Designed for internal expansion only
- Hand and electrically operated installation equipment is available; consult Dixon® for pricing and availability
- Working pressure varies with the size of the fitting, the size and construction of the hose, and the media being conveyed; consult Dixon for recommendations
- Do not interchange with other manufacturers 

### Material

- Male and female stems are machined from bar stock or solid brass forgings; ferrules are available in brass and stainless steel

### Holedall Male Couplings



Size	Thread	Brass Part #
3/4"	NPT	H5192
1"	NST	H5212NST
1-1/4"	NPT	H5222-A
1-3/8"	NPT	H5272 <sup>1</sup>
1-1/2"	NST	H5232NST
2"	NPT	H5242
2-1/2"	NPT	H5252
3"	NPT	H5262

<sup>1</sup> 1-3/8" stem has 1-1/2" thread

### Holedall Female Couplings



Size	Thread	Brass Part #
3/4"	NPSH	H5191-BU
1"	NST	H5211NST
1-1/4"	NPSH	H5221-A-BU
1-3/8"	NPSH	H5271-BU <sup>1</sup>
1-1/2"	NST	H5231NST <sup>2</sup>
2"	NPSH	H5241-BU
2-1/2"	NPSM	H5251L-A-BU <sup>3</sup>
3"	NPSM	H5261 <sup>3</sup>

<sup>1</sup> 1-3/8" stem has 1-1/2" thread

<sup>2</sup> 1-1/2" NST requires special adapter, part # H5231NSTADT

<sup>3</sup> 2-1/2" and 3" parts have female NPSM thread

### Holedall Grooved Couplings



Size	Brass Part #
1"	G5212
1-1/2"	G5232
2"	G5242
2-1/2"	G5252



## Holedall Petroleum Style Series

**Application**

- For use with Holedall Petroleum style couplings on page 582

**Ferrules**

**Feature**

- Eliminates the need for a large stock of coupling bodies
- With a wide range of sizes available, you can build the perfect assembly of a coupling to a corresponding hose size with commercial tolerances, regardless of wall thickness

Hose I.D.	Hose O.D.		Brass Part #
	From	To	
3/4"	1-4/64"	1-7/64"	R75AAAS
	1-8/64"	1-11/64"	R75AAS
	1-12/64"	1-14/64"	R75AS
	1-15/64"	1-17/64"	R75BS
	1-18/64"	1-20/64"	R75CS
1"	1-24/64"	1-26/64"	R1AAAS-A
	1-27/64"	1-29/64"	R1AAS-A
	1-30/64"	1-32/64"	R1AS-A
	1-33/64"	1-35/64"	R1BS-A
	1-36/64"	1-38/64"	R1CS-A
	1-39/64"	1-41/64"	R1DS-A
	1-42/64"	1-44/64"	R1ES-A
1-1/4"	1-39/64"	1-42/64"	R125AAS-A
	1-43/64"	1-46/64"	R125AS-A
	1-47/64"	1-50/64"	R125BS-A
	1-51/64"	1-54/64"	R125CS-A
	1-55/64"	1-58/64"	R125DS-A
	1-59/64"	1-62/64"	R125ES-A
1-3/8"	1-47/64"	1-50/64"	R1375BS
	1-51/64"	1-54/64"	R1375CS
	1-55/64"	1-58/64"	R1375DS
	1-59/64"	1-62/64"	R1375ES
1-1/2"	1-54/64"	1-57/64"	R15AAAS-A
	1-58/64"	1-62/64"	R15AAS-A
	1-63/64"	2-2/64"	R15AS-A
	2-3/64"	2-6/64"	R15BS-A
	2-7/64"	2-11/64"	R15CS-A
	2-12/64"	2-14/64"	R15DS-A
	2-15/64"	2-19/64"	R15ES-A
	2-20/64"	2-24/64"	R15FS-A
	2-25/64"	2-28/64"	R15GS <sup>1</sup>
2"	2-27/64"	2-30/64"	R2AAS
	2-31/64"	2-34/64"	R2AS
	2-35/64"	2-38/64"	R2BS
	2-39/64"	2-42/64"	R2CS
	2-43/64"	2-46/64"	R2DS
	2-47/64"	2-50/64"	R2ES
	2-51/64"	2-54/64"	R2FS
	2-62/64"	3-1/64"	R25AS
2-1/2"	3-2/64"	3-6/64"	R25BS
	3-7/64"	3-11/64"	R25CS
	3-12/64"	3-16/64"	R25DS
	3-17/64"	3-21/64"	R25ES
	3-22/64"	3-26/64"	R25FS
	3-30/64"	3-34/64"	R3AAAS
3"	3-35/64"	3-39/64"	R3AAS
	3-40/64"	3-45/64"	R3AS
	3-46/64"	3-50/64"	R3BS
	3-51/64"	3-54/64"	R3CS



<sup>1</sup> Will be replaced by API ferrules

NOTE: Can be used with crimp fuel couplings on page 584.

## API Certified Attached Holedall Petroleum Male Couplings

### Male Couplings

#### Approval

- Tested and compliant with API 1529 6th edition, coupling procedures, ferrule recommendations, and API test data are available upon request, please contact Dixon® at [engineering@dixonvalve.com](mailto:engineering@dixonvalve.com)

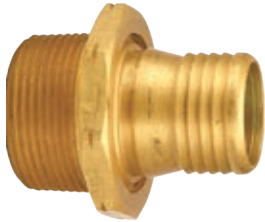

Size	Thread Type	Brass Part #
1"	NPT	H5212-A
1-1/4"		H5222-A
1-1/2"		H5232-A
2"		H5242L-A
2-1/2"		H5252L-A
3"		H5262L-A
4"		H5282L-A

### Female Couplings



Size	Thread Type	Brass Part #
1"	NPSH	H5211-A-BU
1-1/4"		H5221-A-BU
1-1/2"		H5231-A-BU
2"		H5241L-A-BU
2-1/2"	NPSM	H5251L-A-BU
3"		H5261L-A-BU
4"		H5281L-A-BU

## Crimp Fuel Oil Couplings

#### Applications

- Crimpable brass ferrule and stem to outfit fuel oil hose assemblies

#### Features

- Same ferrules are used for crimping as internal expansion on page 585
- Faster assembly time
- Does not require tooling used for internal expansion

#### Specification

- Working pressure: 250 PSI

### Male Couplings



Size	Thread Type	Brass Part #
1"	NPT	H5212CS
1-1/4"		H5222CS
1-3/8"		H5272CS
1-1/2"		H5232CS

### Female Couplings



Size	Thread Type	Brass Part #
1"	NPT	H5211CS
1-1/4"		H5221CS
1-3/8"		H5271CS
1-1/2"		H5231CS

### API Certified Series Ferrules

Hose I.D.	Hose O.D.		Brass Part #	304 Stainless Steel Part #
	From	To		
1"	1-24/64"	1-26/64"	R1AAAS-A	---
	1-27/64"	1-29/64"	R1AAS-A	---
	1-30/64"	1-32/64"	R1AS-A	---
	1-33/64"	1-35/64"	R1BS-A	---
	1-36/64"	1-38/64"	R1CS-A	---
	1-39/64"	1-41/64"	R1DS-A	---
	1-42/64"	1-44/64"	R1ES-A	---
1-1/4"	1-39/64"	1-42/64"	R125AAS-A	---
	1-43/64"	1-46/64"	R125AS-A	---
	1-47/64"	1-50/64"	R125BS-A	---
	1-51/64"	1-54/64"	R125CS-A	---
	1-55/64"	1-58/64"	R125DS-A	---
	1-59/64"	1-62/64"	R125ES-A	---
1-1/2"	1-54/64"	1-57/64"	R15AAAS-A	---
	1-58/64"	1-62/64"	R15AAS-A	---
	1-63/64"	2-2/64"	R15AS-A	---
	2-3/64"	2-6/64"	R15BS-A	---
	2-7/64"	2-11/64"	R15CS-A	---
	2-12/64"	2-14/64"	R15DS-A	---
	2-15/64"	2-19/64"	R15ES-A	---
	2-20/64"	2-24/64"	R15FS-A	---
2"	2-31/64"	2-34/64"	---	R2ASS-A
	2-35/64"	2-38/64"	---	R2BSS-A
	2-39/64"	2-42/64"	---	R2CSS-A
	2-43/64"	2-46/64"	---	R2DSS-A
	2-47/64"	2-50/64"	---	R2ESS-A
2-1/2"	2-62/64"	3-1/64"	---	R25ASS-A
	3-2/64"	3-6/64"	---	R25BSS-A
	3-7/64"	3-11/64"	---	R25CSS-A
	3-12/64"	3-16/64"	---	R25DSS-A
3"	3-17/64"	3-21/64"	---	R25ESS-A
	3-35/64"	3-39/64"	---	R3AASS-A
	3-40/64"	3-45/64"	---	R3ASS-A
	3-46/64"	3-50/64"	---	R3BSS-A
	3-51/64"	3-54/64"	---	R3CSS-A
4"	3-55/64"	3-59/64"	---	R3DSS-A
	4-46/64"	4-48/64"	---	R4ESS-A
	4-49/64"	4-51/64"	---	R4FSS-A
	4-52/64"	4-54/64"	---	R4GSS-A
	4-55/64"	4-57/64"	---	R4HSS-A
	4-58/64"	4-59/64"	---	R4KSS-A
	4-60/64"	4-62/64"	---	R4LSS-A
4-63/64"	5"	---	R4MSS-A	



brass



304 stainless steel

NOTE: For use with API couplings on page 584

### Female Replacement Washers

**Application**

- For use with female internally expanded Holedall couplings on page 584



Size	Nitrile Rubber Part #
3/4"	H5071-BU
1"	H5072-BU
1-1/4"	H5073-BU
1-1/2"	H5074-BU
2"	H5075-BU
2-1/2"	H5076-BU
3"	H5077-BU
4"	H5078-BU

### HB Coupling Expander Machine

**Application**

- For use in a fixed location for small production runs or as a portable repair type expander



**Features**

- Hand operated, pull-through type expander
- Attaches sizes 3/4" through 2" of the Holedall Petroleum style and all sizes of the curb pump fittings
- Expander tooling sold separately

**Part #**

2500HB0000

### Pump Hose Couplings

**Application**

- Economical and trouble-free couplings for gas pump hose

**Features**

- Serrations on the stem embed in the hose, eliminating wicking and leakage
- Shell extends beyond the stem preventing cutting of interior walls; tapered ends of stem and shell protect hose when flexed
- Provide tamper-proof static connection, which cannot be broken without completely damaging coupling and hose
- Internal expansion of stem to nominal I.D. of hose provides full flow
- Broad, firm grip of coupling extends hose life by making it possible for hose to withstand repeated bending
- Hand and electrically operated installation equipment is available; consult Dixon® for pricing and availability
- Reattach static wire if required 

**Approval**

- UL recognized



Fluid Hose number (MH49909)

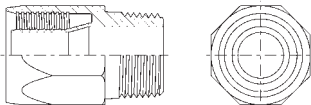

Size	Male NPT	Hose O.D.	Chrome Plated Brass Part #
3/4"	3/4"	1-9/64"	H5751
		1-11/64"	H5752
		1-13/64"	H5753
		1-7/32"	H5754
		1-17/64"	H5755 <sup>1</sup>
1"	1"	1-25/64"	H5771
		1-29/64"	H5772
		1-1/2"	H5773
		1-9/16"	H5774

<sup>1</sup> Thrust plate required, part # 25000HTL15

## Dubl-Grip Field Attachable Couplings for Curb Pump Hose

### Features

- Two-piece construction
- Streamlined design prevents damage to hose and fits well on new pump equipment
- Wide, flat surfaces of body threads protect inside of hose from breaking
- Tapered surface of sleeve and body cradle hose preventing one-point strain from flexing
- Hose is gripped on its full circumference in two places, ensuring a rigid leakproof connection
- Easy assembly:
  - Hose is held in position by sleeve as body is threaded home.
  - Only a wrench is required to assemble the Dubl-Grip.
- Reattach static wire if required 

**CAUS**  
 Fluid hose number  
 (MH49909)

### Approval

- UL recognized

### Swivel

Hose I.D.	Male NPT	Hose O.D.	Chrome Plated Brass Part #
3/4"	3/4"	1-1/8"	H603
		1-13/64"	H604
		1-1/4"	H605
1"	1"	1-3/8"	H609 <sup>1</sup>
		1-7/16"	H610 <sup>1</sup>
		1-1/2"	H611 <sup>1</sup>

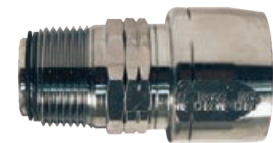

### Non-Swivel

Hose I.D.	Male NPT	Hose O.D.	Chrome Plated Brass Part #
5/8"	3/4"	1"	850212
		1-1/32"	850213
3/4"		1-1/8"	850451
		1-13/64"	850455
		1-1/4"	850453
1"	1"	1-3/8"	850841 <sup>1</sup>
		1-7/16"	850801 <sup>1</sup>
		1-1/2"	850811 <sup>1</sup>



<sup>1</sup> Octagonal shape

## CIP Internal Expansion (IX) Sanitary Style Hose Couplings

### Applications

- Used in the food, dairy, and beverage industries

### Feature

- Flow Chief internal expansion (IX) fittings are only to be used with Flow Chief stainless steel ferrules

### Approval

- Clean-in-place (CIP) compliant

### Sanitary Style Clamp End Stems

### Features

- See pages 673 - 681 for sanitary style gaskets
- See pages 595 - 598 for sanitary style clamps

### Approvals

- 3A compliant when assembled by 3A authorized hose shop
- Special plug is required to expand CIP compliant fittings
- Special adapter plate is required to expand 1-1/2" CIP compliant fittings



Size	304 Stainless Steel Part #
1-1/2"	IXSE24-3A
2"	IXSE32-3A
3"	IXSE48-3A

### Special Expansion Plugs for CIP Compliant IX Fitting



Hose Size	304 Stainless Steel Part #
1-1/2"	IXFDPLG137
2"	IXFDPLG187
3"	IXFDPLG287

## CIP Internal Expansion (IX) Sanitary Style Tube Weld End Stem

### Feature

- Special plug is required to expand CIP compliant fittings



Size	304 Stainless Steel Part #
2"	IXPE32-3A

## Internal Expansion (IX) Sanitary Style Clamp End Stems

### Features

- Clamp end x hose shank
- Flow Chief internal expansion (IX) fittings are only to be used with Flow Chief stainless steel ferrules
- See pages 673 - 681 for sanitary style gaskets
- See pages 595 - 598 for sanitary style clamps



Size	304 Stainless Steel Part #
1-1/2"	IXSE24
2"	IXSE32
2-1/2"	IXSE40
3"	IXSE48
4"	IXSE64

## Internal Expansion (IX) Sanitary Style

### Male NPT Stems

**Feature**

- Flow Chief internal expansion (IX) fittings are only to be used with Flow Chief stainless steel ferrules

Size	304 Stainless Steel Part #
1-1/2"	IXMS24
2"	IXMS32
2-1/2"	IXMS40
3"	IXMS48
4"	IXMS64



## Internal Expansion (IX) Sanitary Style Bevel Seat Hose Couplings

**Features**

- Flow Chief internal expansion (IX) fittings are only to be used with Flow Chief stainless steel ferrules
- See pages 682 - 683 for bevel seat gaskets

### Bevel Seat Stems

**Feature**

- Only use with the IXAN nuts shown below

Size	304 Stainless Steel Part #
1-1/2"	IXFS24
2"	IXFS32
2"	IXFS32-3A <sup>1</sup>
2-1/2"	IXFS40
3"	IXFS48
4"	IXFS64



<sup>1</sup> Must use plug part # IXFDPLG187

### Bevel Seat Threaded Hex Nuts

#### Series 13H (modified)

Size	304 Stainless Steel Part #
1-1/2"	IXAN24
2"	IXAN32
2-1/2"	IXAN40
3"	IXAN48
4"	IXAN64



## Internal Expansion Sanitary Style Flow Chief Ferrules

**Feature**

- Ferrule I.D.s are designed in increments of 1/16"



Hose I.D.	Hose O.D.		304 Stainless Steel Part #
	From	To	
1-1/2" <sup>1</sup>	1-56/64"	1-59/64"	24PFX1.937
	1-60/64"	1-63/64"	24PFX2.000
	2"	2-3/64"	24PFX2.062
	2-4/64"	2-7/64"	24PFX2.125
	2-8/64"	2-11/64"	24PFX2.187
	2-12/64"	2-15/64"	24PFX2.250
	2-16/64"	2-19/64"	24PFX2.312 <sup>2</sup>
2" <sup>1</sup>	2-28/64"	2-31/64"	32PFX2.500
	2-32/64"	2-35/64"	32PFX2.562
	2-36/64"	2-39/64"	32PFX2.625
	2-40/64"	2-43/64"	32PFX2.687
	2-44/64"	2-47/64"	32PFX2.750
	2-48/64"	2-51/64"	32PFX2.812
	2-52/64"	2-55/64"	32PFX2.875
	2-56/64"	2-59/64"	32PFX2.937
2-1/2"	3"	3-3/64"	40PFX3.062
	3-4/64"	3-7/64"	40PFX3.125
	3-8/64"	3-11/64"	40PFX3.187
	3-12/64"	3-15/64"	40PFX3.250
	3-16/64"	3-19/64"	40PFX3.312
	3-20/64"	3-23/64"	40PFX3.375
	3-28/64"	3-31/64"	40PFX3.500
3"	3-32/64"	3-35/64"	48PFX3.562
	3-36/64"	3-39/64"	48PFX3.625
	3-40/64"	3-43/64"	48PFX3.687
	3-44/64"	3-47/64"	48PFX3.750
	3-48/64"	3-51/64"	48PFX3.812
	3-52/64"	3-55/64"	48PFX3.875
	3-56/64"	3-59/64"	48PFX3.937
	3-60/64"	3-63/64"	48PFX4.000
	4"	4-3/64"	48PFX4.062
4"	4-4/64"	4-7/64"	48PFX4.125
	4-36/64"	4-39/64"	64PFX4.625
	4-40/64"	4-43/64"	64PFX4.687
	4-44/64"	4-47/64"	64PFX4.750
	4-48/64"	4-51/64"	64PFX4.812
	4-52/64"	4-55/64"	64PFX4.875
	4-56/64"	4-59/64"	64PFX4.937

<sup>1</sup> 1-1/2" and 2" ferrules do not have serrations on the I.D.

<sup>2</sup> Consult Dixon® at [engineering@dixonvalve.com](mailto:engineering@dixonvalve.com) for working pressure

NOTE: For use with IX stems on pages 588 - 589



## Dixon Sanitary King Crimp® Style Stem

**Feature**

- To be used with King Crimp sleeves and / or ferrules see pages 13 - 16

**Approval**

- Wetted surfaces meet governmental and independent regulatory standards only

### Clamp End x Hose Shank Stems

Size	316 Stainless Steel Part #
1"	CSSR100CS
1-1/2"	CSSR150CS
2"	CSSR200CS
3"	CSSR300CS
4"	CSSR400CS



### Female I-line x Hose Shank Stems

Size	316 Stainless Steel Part #
1"	CILR100CS
1-1/2"	CILR150CS
2"	CILR200CS
3"	CILR300CS
4"	CILR400CS



## Holedall DIN External

### Crimp Female Stems

Size	DIN	316 Stainless Steel Part #
1-1/2"	40	HA0240
2"	50	HA0241
2-1/2"	65	HA0242
3"	80	HA0243



### Male Stems

Size	DIN	316 Stainless Steel Part #
1-1/2"	40	HA0235
2"	50	HA0236
2-1/2"	65	HA0237
3"	80	HA0238



NOTE: Please visit [dixonvalve.com](http://dixonvalve.com) for crimp recommendations. To be used with Dixon sanitary style crimp ferrules on page 593

## Dixon Sanitary Style Crimp Stems

### Clamp End x Hose Shank

**Features**

- Sanitary style end
- Dixon® sanitary crimp stems are only to be used with Dixon sanitary stainless steel crimp ferrules on page 593
- Reference dixonvalve.com for crimp recommendations



Size	316 Stainless Steel Part #
1"	CSSR100-3A
1-1/2"	CSSR150-3A
2"	CSSR200-3A
2-1/2"	CSSR250
3"	CSSR300-3A
4"	CSSR400

### Female I-Line End x Hose Shank

**Feature**

- To be used with sanitary ferrules on page 593



Size	316 Stainless Steel Part #
1-1/2"	CILR150
2"	CILR200
3"	CILR300
4"	CILR400

### Bevel Seat End x Hose Shank

**Feature**

- To be used with sanitary ferrules on page 593

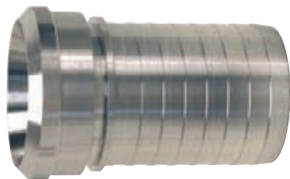

Size	Nut Used	316 Stainless Steel Part #
1"	13H-G100	CBSR100
1-1/2"	IXAN24	CBSR150
2"	IXAN32	CBSR200
3"	IXAN300	CBSR300
4"	IXAN64	CBSR400

### Tube Weld End x Hose Shank

**Feature**

- To be used with sanitary ferrules on page 593



Size	316 Stainless Steel Part #
1-1/2"	CTER150
2"	CTER200
3"	CTER300
4"	CTER400

L

## Dixon® Sanitary Style Crimp Ferrules

**Material**

- AISI 304 stainless steel

**Approval**

- Ferrules have a surface finish of 63 or better

Size	Hose O.D.		AISI 304 Stainless Steel Part #
	From	To	
1"	1-26/64"	1-28/64"	F16G-1453
	1-29/64"	1-31/64"	F16G-1500
	1-32/64"	1-34/64"	F16G-1547
	1-35/64"	1-37/64"	F16G-1594
	1-38/64"	1-40/64"	F16G-1641
	1-41/64"	1-43/64"	F16G-1687
	1-44/64"	1-46/64"	F16G-1734
	1-47/64"	1-49/64"	F16G-1781
1-1/2"	1-58/64"	1-61/64"	F24G-1969
	1-62/64"	2-1/64"	F24G-2031
	2-2/64"	2-5/64"	F24G-2094
	2-6/64"	2-9/64"	F24G-2156
	2-10/64"	2-13/64"	F24G-2219
	2-14/64"	2-17/64"	F24G-2281
	2-18/64"	2-21/64"	F24G-2344
	2-22/64"	2-25/64"	F24G-2406
2"	2-30/64"	2-33/64"	F32G-2531
	2-34/64"	2-37/64"	F32G-2594
	2-38/64"	2-41/64"	F32G-2656
	2-42/64"	2-45/64"	F32G-2719
	2-46/64"	2-48/64"	F32G-2766
	2-49/64"	2-51/64"	F32G-2815
	2-52/64"	2-55/64"	F32G-2875
	2-56/64"	2-59/64"	F32G-2938
	2-60/64"	2-63/64"	F32G-3000
	3"	3-3/64"	F32G-3063
3-4/64"	3-7/64"	F32G-3125	
2-1/2"	3"	3-3/64"	F40G-3063
	3-4/64"	3-7/64"	F40G-3125
	3-8/64"	3-11/64"	F40G-3188
	3-12/64"	3-15/64"	F40G-3250
	3-16/64"	3-19/64"	F40G-3313
	3-20/64"	3-23/64"	F40G-3375
	3-24/64"	3-26/64"	F40G-3437
3"	3-36/64"	3-39/64"	F48G-3625
	3-40/64"	3-43/64"	F48G-3688
	3-44/64"	3-47/64"	F48G-3750
	3-48/64"	3-51/64"	F48G-3813
	3-52/64"	3-55/64"	F48G-3875
	3-56/64"	3-59/64"	F48G-3938
	3-61/64"	4"	F48G-4016
4"	4-40/64"	4-43/64"	F64G-4688
	4-44/64"	4-47/64"	F64G-4750
	4-48/64"	4-51/64"	F64G-4813
	4-52/64"	4-55/64"	F64G-4875
	4-56/64"	4-59/64"	F64G-4938
	5-5/64"	5-8/64"	F64G-5141



**Sanitary Tube Fittings..... 595 - 711**

Clever Clamp™ ..... 595  
 Clamps ..... 596 - 598  
 Spring loaded nut ..... 598  
 Clamp accessories ..... 599  
 Clamp fittings ..... 600 - 613  
     Ferrules ..... 600 - 601  
     Elbows ..... 602 - 603  
     Tees ..... 604  
     Reducers ..... 605 - 606  
     Caps ..... 607  
     Adapters ..... 608 - 611  
     Laterals, wyes, crosses, bends, and flanges ..... 612 - 613  
 Sanitary spools ..... 614  
 Weld ..... 615 - 624  
     Elbows ..... 615 - 616  
     Sweep elbows ..... 617  
     Tees ..... 618 - 619  
     Reducers ..... 620 - 621  
     Caps ..... 621  
     Adapters ..... 622  
     Laterals, wyes, crosses, bends, and flanges ..... 623 - 624  
     Gaskets ..... 624  
 Unpolished weld ..... 625 - 629  
     Elbows ..... 625  
     Tees ..... 626  
     Reducers ..... 627  
     Laterals, wyes, bends, and flanges ..... 628 - 629  
     Gaskets ..... 629  
 Bevel seat ..... 630 - 636  
     Nuts ..... 630  
     Hex wrenches ..... 630  
     Ferrules ..... 631 - 633  
     Elbows ..... 634  
     Reducers ..... 635  
     Caps ..... 636  
     Adapters ..... 636  
 I-line / Q-line ..... 637 - 642  
     Clamps ..... 637  
     Ferrules ..... 638 - 640  
     Elbows ..... 640  
     End caps ..... 641  
     Adapters ..... 642  
 John Perry ..... 643 - 645  
     Nuts ..... 643  
     Wrenches ..... 643  
     Ferrules ..... 644  
     End caps ..... 645  
 European fittings ..... 646 - 648  
     DIN ..... 646  
     SMS ..... 647  
     RJT ..... 648  
 High purity Biopharm fittings ..... 649 - 663  
     Caps ..... 649  
     Adapters ..... 650  
     Ferrules ..... 651  
     Elbows ..... 652  
     Tees ..... 653 - 657  
     Reducers ..... 658 - 663  
 Pipe size ..... 664 - 670  
     Clamps ..... 664

**Sanitary Tube Fittings (cont.)..... 595 - 711**

Ferrules ..... 664 - 665  
 End caps ..... 665  
 Adapters ..... 666  
 Hangers ..... 667 - 670  
 Gaskets ..... 671 - 689  
     Schedule 5S and 10S ..... 671 - 672  
     Sanitary ..... 673  
     Clamp ..... 674 - 681  
     Bevel seat ..... 682 - 683  
     I-line / Q-line ..... 684 - 685  
     John Perry ..... 686 - 687  
     European ..... 688 - 689  
 Gasket fittings and sizing guide ..... 690 - 692  
 Sanitary tubing ..... 693  
 ASTM-A270 polished I.D. / O.D. tubing ..... 694 - 695  
 Tube hangers ..... 696 - 703  
     Hex ..... 696 - 700  
     Block ..... 701 - 702  
     Process ..... 703  
 Wall flanges ..... 704  
 Pressure gauges ..... 705 - 709  
 Thermometers ..... 710  
 RTDs and temperature transmitters ..... 711

**Vacuum Fittings ..... 712 - 732**

KF flange ..... 712 - 713  
 KF ring ..... 713 - 714  
 KF bellow ..... 714  
 KF clamp ..... 714  
 ISO flange ..... 715 - 716  
 ISO ring ..... 716  
 ISO bellow ..... 716  
 ISO clamp ..... 716  
 Vacuum weld ..... 717 - 719  
     Elbows ..... 717 - 718  
     Reducers ..... 719  
     Tees ..... 719  
 Material test reports ..... 720

**Breakaway Couplings ..... 721**

**Spray Balls ..... 722**

**Sight Glasses ..... 723 - 725**

**Swivels ..... 726**

**Cartridge Filter Elements ..... 727 - 731**

**Strainers ..... 732 - 734**

**Sanitary Valves ..... 735 - 749**

Tank vent valve ..... 735  
 2-way, 3-piece ball valves ..... 736 - 737  
 Butterfly valves ..... 738 - 742  
     Clamp end ..... 738 - 741  
     B5116 series ..... 742  
 Spring check valves ..... 743  
 Y ball check valves ..... 744  
 Air blow check valves ..... 745  
 Air relief check valves ..... 746  
 Air / vacuum relief tank valve ..... 747 - 748  
 3A sample valves ..... 749

M

### Clever Clamp™

**Features**

- Consistent compression of the gasket with every use - no concern for damage to gasket or creation of internal bacterial traps from improper compression
- Adjustable for both rubber and PTFE gasket styles
- Fast installation, no torquing tools required
- Thread-less design eliminates risk of crushed pin threads
- Lockout ready design
- Self-locking lever and color-coding options available

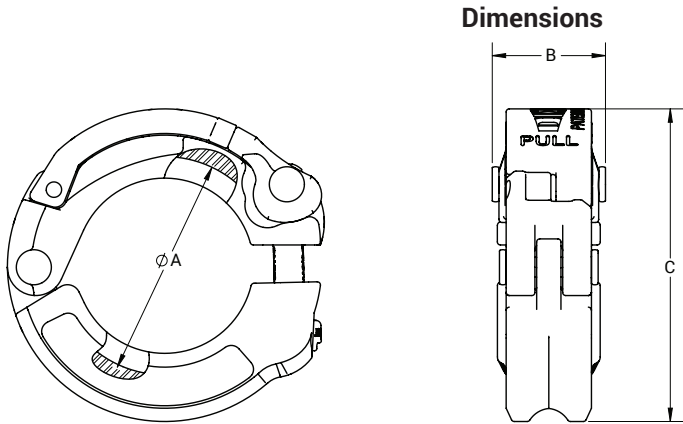

Tube O.D.	Service Pressure Rating PSI @ 70°F (21°C) <sup>1</sup>	Service Pressure Rating PSI @ 250°F (121°C) <sup>1</sup>	A (in)	B (in)	C (in)	304 Stainless Steel Part #	Clever Clamp with 304 Stainless Steel Part #
1-1/2"	500	300	2.14	1.10	3.04	13SCC-100150	13SCC-100150L
2"	450	250	2.65	1.10	3.53	13SCC-200	13SCC-200L
3"	350	175	3.72	1.10	4.59	13SCC-300	13SCC-300L

<sup>1</sup> Service ratings are based on hydrostatic tests using standard-molded nitrile rubber, EPDM, FKM, and silicone material gaskets, with proper installation of ferrules, assembly of joints and absence of shock pressure or water hammer. Contact Dixon for service of other type and material gaskets. All ratings shown are dependent upon related components within the systems and proper installation of those components. For temperatures above 250°F, we cannot provide service ratings. Before installation, testing must be done under the specific conditions of your application. Verify specific gasket material temperature ratings. This information is only applicable if Dixon clamps, ferrules, and gaskets are used. Dixon cannot guarantee the quality or integrity of other manufacturers components.

**M**

#### Food Grade Silicone Color I.D. Bands - 25pcs/pack

Color	Part #
Red	13SCC-CB-R
Green	13SCC-CB-G
Blue	13SCC-CB-B
Yellow	13SCC-CB-Y



Clamps

Service pressure ratings are based on the following parameters: matching elastomer gaskets and weld ferrules properly aligned and assembled with the clamps tightened to the required torques. Tests are done hydrostatically with no water hammer or shock loads. Please note the pressure ratings of the described unions may be above the recommended pipe line operating pressures. 

Single Pin Squeeze Clamps - 13MHHM-Q

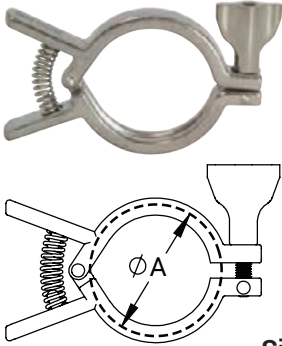

Tube O.D.	Service Pressure Rating PSI @ 70°F (21°C) <sup>1</sup>	Service Pressure Rating PSI @ 250°F (121°C) <sup>1</sup>	A (in)	304 Stainless Steel Part #
1/2" - 3/4"	1500	1200	1.06	13MHHM-Q75
1" - 1-1/2"	500	300	2.12	13MHHM-Q100150
2"	450	250	2.65	13MHHM-Q200
2-1/2"	400	200	3.18	13MHHM-Q250
3"	350	175	3.72	13MHHM-Q300
4"	300	150	4.82	13MHHM-Q400

<sup>1</sup>Wing nut tightened to 25 in. lbs. of torque

Single Pin Heavy Duty Clamps with Cross Hole Wing Nut - 13MHHM

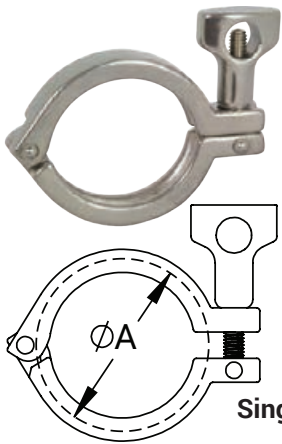

Tube O.D.	Service Pressure Rating PSI @ 70°F (21°C) <sup>1</sup>	Service Pressure Rating PSI @ 250°F (121°C) <sup>1</sup>	A (in)	304 Stainless Steel Part #
1/2" - 3/4"	1500	1200	1.06	13MHHM50-75
1" - 1-1/2"	500	300	2.12	13MHHM100-150
2"	450	250	2.65	13MHHM200
2-1/2"	400	200	3.19	13MHHM250
3"	350	175	3.72	13MHHM300
4"	300	150	4.82	13MHHM400
5"	225	100	5.82	13MHHM500
6"	150	75	6.69	13MHHM600
8"	100	50	8.69	13MHHM800

<sup>1</sup>Wing nut tightened to 25 in. lbs. of torque

Single Pin Heavy Duty Clamps with Serrated Wing Nut - 13MHHM\*\*\*SN

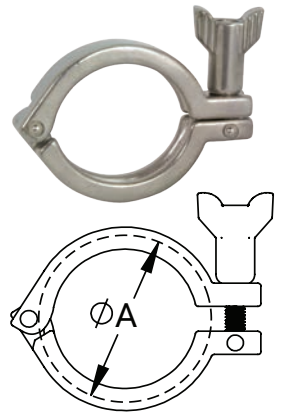

Tube O.D.	Service Pressure Rating PSI @ 70°F (21°C) <sup>1</sup>	Service Pressure Rating PSI @ 250°F (121°C) <sup>1</sup>	A (in)	304 Stainless Steel Part #
1/2" - 3/4"	1500	1200	1.06	13MHHM50-75SN
1" - 1-1/2"	500	300	2.12	13MHHM100-150SN
2"	450	250	2.65	13MHHM200SN
2-1/2"	400	200	3.19	13MHHM250SN
3"	350	175	3.72	13MHHM300SN
4"	300	150	4.82	13MHHM400SN
5"	225	100	5.82	13MHHM500SN
6"	150	75	6.70	13MHHM600SN
8"	100	50	8.70	13MHHM800SN

<sup>1</sup>Wing nut tightened to 25 in. lbs. of torque

Single Pin Heavy Duty Clamps with Hex Nut - 13MHHM\*\*\*WNH

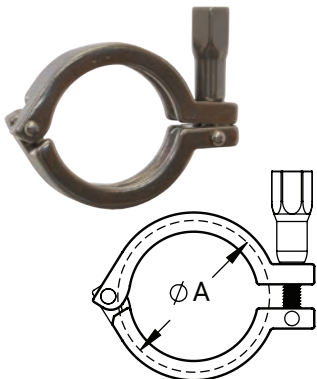

Tube O.D.	Service Pressure Rating PSI @ 70°F (21°C) <sup>1</sup>	Service Pressure Rating PSI @ 250°F (121°C) <sup>1</sup>	A (in)	304 Stainless Steel Part #
1/2" - 3/4"	1500	1200	1.06	13MHHM50-75WNH
1" - 1-1/2"	500	300	2.12	13MHHM100150WNH
2"	450	250	2.65	13MHHM200WNH
2-1/2"	400	200	3.19	13MHHM250WNH
3"	350	175	3.72	13MHHM300WNH
4"	300	150	4.82	13MHHM400WNH
5"	225	100	5.82	13MHHM500WNH
6"	150	75	6.70	13MHHM600WNH
8"	100	50	8.70	13MHHM800WNH

<sup>1</sup>Wing nut tightened to 25 in. lbs. of torque

M

### Clamps

#### Double Pin Heavy Duty Clamps - 13MHHM-DP

Tube O.D.	Service Pressure Rating PSI @ 70°F (21°C) <sup>1</sup>	Service Pressure Rating PSI @ 250°F (121°C) <sup>1</sup>	A (in)	304 Stainless Steel Part #
1" - 1-1/2"	500	300	2.12	13MHHM-DP100150
2"	450	250	2.65	13MHHM-DP200
2-1/2"	400	200	3.19	13MHHM-DP250
3"	350	175	3.72	13MHHM-DP300
4"	300	150	4.82	13MHHM-DP400
10"	100	50	10.74	13MHHM-DP1000

<sup>1</sup>Wing nut tightened to 25 in-lb of torque

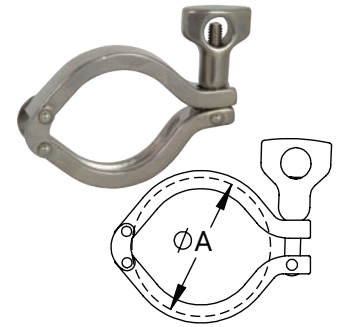

#### Three Segment Clamps - 13MHHM-3P

Tube O.D.	Service Pressure Rating PSI @ 70°F (21°C) <sup>1</sup>	Service Pressure Rating PSI @ 250°F (121°C) <sup>1</sup>	A (in)	304 Stainless Steel Part #
1" - 1-1/2"	600	300	2.12	13MHHM-3P100150
2"	550	275	2.65	13MHHM-3P200
2-1/2"	450	225	3.19	13MHHM-3P250
3"	350	175	3.72	13MHHM-3P300
4"	300	150	4.82	13MHHM-3P400
12"	75	50	12.74	13MHHM-3P1200

<sup>1</sup>Wing nut tightened to 25 in-lb of torque

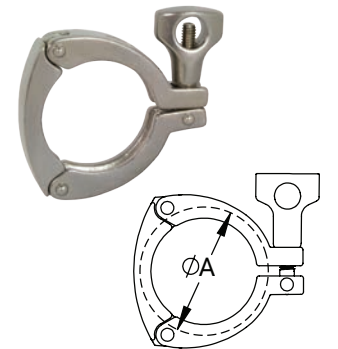

#### Bolted Clamps - 13MHP

Tube O.D.	Service Pressure Rating PSI @ 70°F (21°C) <sup>1</sup>	Service Pressure Rating PSI @ 250°F (121°C) <sup>1</sup>	A (in)	304 Stainless Steel Part #
1/2" - 3/4"	1500	1200	1.06	13MHP75
1" - 1-1/2"	1500	1200	2.05	13MHP100-150
2"	1000	800	2.58	13MHP200
2-1/2"	1000	800	3.11	13MHP250
3"	1000	800	3.64	13MHP300
4"	800	600	4.74	13MHP400
5"	300	200	5.76	13MHP500
6"	300	200	6.63	13MHP600
8"	250	150	8.64	13MHP800
10"	200	125	10.74	13MHP1000
12"	150	100	12.74	13MHP1200

<sup>1</sup>All nuts are tightened to 20 ft-lb of torque

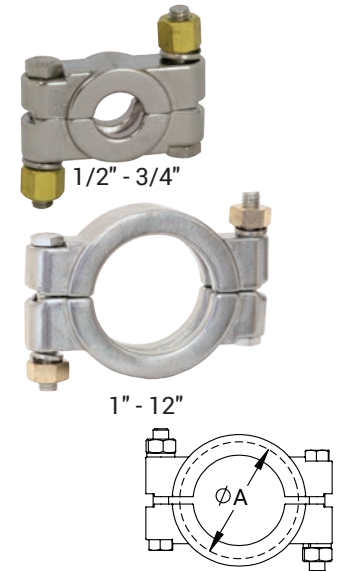

**M**

#### Toggle Clamps - 13MHLA

Tube O.D.	Service Pressure Rating PSI @ 70°F (21°C) <sup>1</sup>	Service Pressure Rating PSI @ 250°F (121°C) <sup>1</sup>	A (in)	304 Stainless Steel Part #
1" - 1-1/2"	150	125	2.12	13MHLA100-150
2"	150	125	2.65	13MHLA200
2-1/2"	150	125	3.19	13MHLA250
3"	150	125	3.72	13MHLA300
4"	100	75	4.82	13MHLA400

<sup>1</sup>Screw tightened to maximum

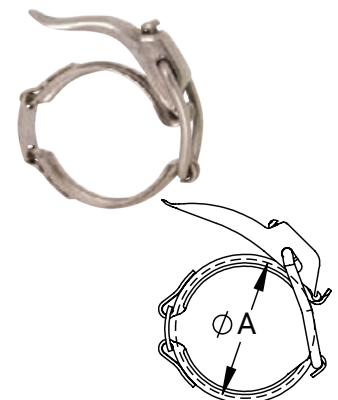

Clamps

T-bolt Clamps - 13MO

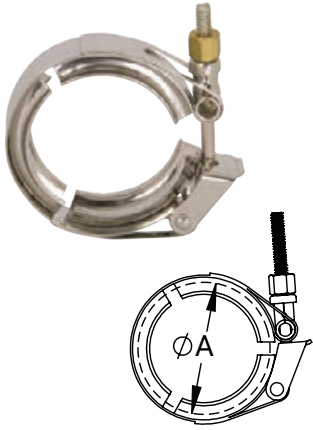

Tube O.D.	Service Pressure Rating PSI @ 70°F (21°C) <sup>1</sup>	Service Pressure Rating PSI @ 250°F (121°C) <sup>1</sup>	A (in)	304 Stainless Steel Part #
1" - 1-1/2"	500	250	2.08	13MO100-150
2"	350	200	2.61	13MO200
2-1/2"	300	150	3.14	13MO250
3"	200	100	3.67	13MO300
4"	100	75	4.78	13MO400
6"	75	50	6.69	13MO600
8" <sup>2</sup>	50	40	8.69	13MO800
10" <sup>2</sup>	40	30	10.69	13MO1000
12" <sup>2</sup>	30	25	12.69	13MO1200

<sup>1</sup> 1" - 3" nuts tightened to 20 in-lb, 4" to 30 in-lb, 6" to 40 in-lb, and 8" - 12" 50 in-lb of torque.

<sup>2</sup> 2-bolt configuration

Dairy Clamps - 13WGC



Tube O.D.	Service Pressure Rating PSI @ 70°F (21°C) <sup>1</sup>	Service Pressure Rating PSI @ 250°F (121°C) <sup>1</sup>	A (in)	304 Stainless Steel Part #
1" - 1-1/2"	100	75	2.08	13WGC100-150
2"	100	75	2.61	13WGC200
2-1/2"	100	75	3.14	13WGC250
3"	100	75	3.67	13WGC300
4"	100	75	4.78	13WGC400

<sup>1</sup>Finger tight

Spring Loaded Nut - 13SLN

Features

- Lines using PTFE gaskets that are subject to large temperature swings can benefit from this special product, as the PTFE is compressed through the cycling of the lines, the spring loaded nut will help keep the connection from leaking
- Ideal for use in high vibration applications where standard wing nuts can loosen and where bolted clamps are not an option

Specification

- Torque to 50 in-lb

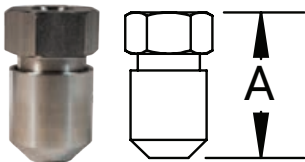

Thread	A (in)	304 Stainless Steel Part #
5/16" - 18	1.73	13SLN

NOTE: Can be used on all wing nut style clamps.

M



## Accessories

Description	304 Stainless Steel Part #
cross hole wing nut 5/16"-18	13WNX
Description	304 Stainless Steel Part #
mini cross hole wing nut 5/16"-18 for 1/2" - 3/4" clamps	13WNXM
Description	304 Stainless Steel Part #
serrated wing nut 5/16"-18	13WNS
Description	304 Stainless Steel Part #
hex nut 5/16"-18	13WNH
Description	Part #
brass 3/8-16 nuts used on bolted clamps	13BNH
Description	304 Stainless Steel Part #
stainless steel hex nut for bolted clamps	13SN
Description	304 Stainless Steel Part #
3/8" 304 stainless steel lock washer	13LW
Description	304 Stainless Steel Part #
bolt 3/8"-16 x 2-1/4" for 1/2" - 1-1/2" bolted clamps	13CB-2.25
bolt 3/8"-16 x 2-3/4" for 2" and 2-1/2" bolted clamps	13CB-2.75
bolt 3/8"-16 x 3-1/4" for 3" - 12" bolted clamps	13CB-3.25
Description	304 Stainless Steel Part #
rivet pin for 1/2" - 5" single pin clamps 5/16" x 1"	13RP
rivet pin for 6" and 8" single pin clamps 5/16" x 1-1/8"	13RP6
Description	304 Stainless Steel Part #
5/16"-18 x 2" threaded eye bolt for 1/2" - 5" clamps	13IB
5/16"-18 x 2-1/2" threaded eye bolt for 6" - 12" clamps	13IB6



M

3 63-04  
621

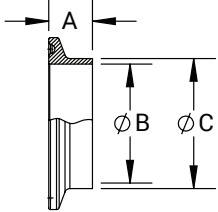

**Clamp Fittings - Ferrules**  
**Short Weld Ferrules - 14WMP**

Tube O.D.	A (in)	B (in)	C (in)	304 Stainless Steel Part #	316L Stainless Steel Part #
1/2"	.50	.37	.50	14WMP-G50	14WMP-R50
3/4"	.50	.62	.75	14WMP-G75	14WMP-R75
1"	.50	.87	1.00	14WMP-G100	14WMP-R100
1-1/2"	.50	1.37	1.50	14WMP-G150	14WMP-R150
2"	.50	1.87	2.00	14WMP-G200	14WMP-R200
2-1/2"	.50	2.37	2.50	14WMP-G250	14WMP-R250
3"	.50	2.87	3.00	14WMP-G300	14WMP-R300
4"	.62	3.83	4.00	14WMP-G400	14WMP-R400
5"	.75	4.78	5.00	14WMP-G500	14WMP-R500
6"	.88	5.78	6.00	14WMP-G600	14WMP-R600
8"	.88	7.78	8.00	14WMP-G800	14WMP-R800
10"	.88	9.76	10.00	14WMP-G1000	14WMP-R1000
12"	.88	11.76	12.00	14WMP-G1200	14WMP-R1200

3 63-04  
621

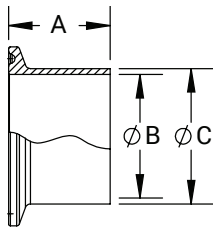

**Long Weld Ferrules - L14AM7**

Tube O.D.	A (in)	B (in)	C (in)	304 Stainless Steel Part #	316L Stainless Steel Part #
1/2"	1.13	.37	.50	L14AM7-G50	L14AM7-R50
3/4"	1.13	.62	.75	L14AM7-G75	L14AM7-R75
1"	1.13	.87	1.00	L14AM7-G100	L14AM7-R100
1-1/2"	1.13	1.37	1.50	L14AM7-G150	L14AM7-R150
2"	1.13	1.87	2.00	L14AM7-G200	L14AM7-R200
2-1/2"	1.13	2.37	2.50	L14AM7-G250	L14AM7-R250
3"	1.13	2.87	3.00	L14AM7-G300	L14AM7-R300
4"	1.13	3.83	4.00	L14AM7-G400	L14AM7-R400
5"	1.13	4.78	5.00	L14AM7-G500	L14AM7-R500
6"	1.50	5.78	6.00	L14AM7-G600	L14AM7-R600
8"	1.50	7.78	8.00	L14AM7-G800	L14AM7-R800
10"	1.75	9.76	10.00	L14AM7-G1000	L14AM7-R1000
12"	1.75	11.76	12.00	L14AM7-G1200	L14AM7-R1200

M

**Reducing Roll-on Ferrules for Expanding - B31RMP**

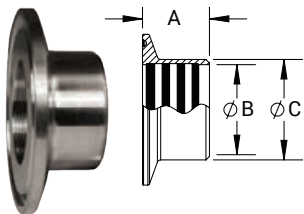

Clamp End	Tube O.D.	A (in)	B (in)	C (in)	304 Stainless Steel Part #
2"	1"	.75	1.00	1.16	B31RMP-G200100
2"	1-1/2"	1.13	1.50	1.68	B31RMP-G200150

**Reducing Ferrules - B31WMP**

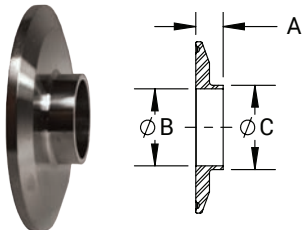

Tube O.D.	A (in)	B (in)	C (in)	304 Stainless Steel Part #	316L Stainless Steel Part #
2" x 1"	.50	.87	1.00	B31WMP-G200100	B31WMP-R200100
2" x 1-1/2"	.50	1.37	1.50	B31WMP-G200150	B31WMP-R200150
2-1/2" x 1-1/2"	.50	1.37	1.50	B31WMP-G250150	B31WMP-R250150
2-1/2" x 2"	.50	1.87	2.00	B31WMP-G250200	B31WMP-R250200
3" x 2"	.50	1.87	2.00	B31WMP-G300200	B31WMP-R300200
3" x 2-1/2"	.50	2.37	2.50	B31WMP-G300250	B31WMP-R300250
4" x 2"	.63	1.87	2.00	B31WMP-G400200	B31WMP-R400200
4" x 2-1/2"	.63	2.37	2.50	B31WMP-G400250	B31WMP-R400250
4" x 3"	.63	2.87	3.00	B31WMP-G400300	B31WMP-R400300

NOTE: Additional sizes available.

## Clamp Fittings - Ferrules

## Roll-On Ferrules for Expanding - 14RMP

Tube O.D.	A (in)	B (in)	C (in)	304 Stainless Steel Part #	316L Stainless Steel Part #
1"	.75	1.01	1.16	14RMP-G100	14RMP-R100
1-1/2"	1.13	1.51	1.68	14RMP-G150	14RMP-R150
2"	1.31	2.01	2.19	14RMP-G200	14RMP-R200
2-1/2"	1.38	2.51	2.71	14RMP-G250	14RMP-R250
3"	1.44	3.01	3.22	14RMP-G300	14RMP-R300
4"	1.50	4.01	4.26	14RMP-G400	14RMP-R400
6"	2.00	6.01	6.26	14RMP-G600	---

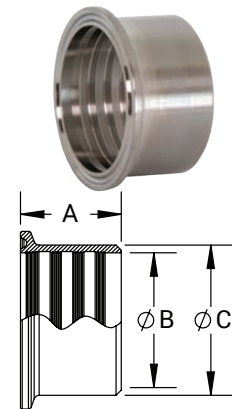

## Automatic Weld Ferrules - TL14AM7

## Approval

- Meets ASME BPE-2019 specifications

Tube O.D.	A (in)	B (in)	C (in)	316L Stainless Steel PL Finish - SF1 Part #	316L Stainless Steel PM Finish - SF4 Part #
1/2"	1.75	.37	.50	TL14AM7-050PL	TL14AM7-050PM
3/4"	1.75	.62	.75	TL14AM7-075PL	TL14AM7-075PM
1"	1.75	.87	1.00	TL14AM7-100PL	TL14AM7-100PM
1-1/2"	1.75	1.37	1.50	TL14AM7-150PL	TL14AM7-150PM
2"	2.25	1.87	2.00	TL14AM7-200PL	TL14AM7-200PM
2-1/2"	2.25	2.37	2.50	TL14AM7-250PL	TL14AM7-250PM
3"	2.25	2.87	3.00	TL14AM7-300PL	TL14AM7-300PM
4"	2.25	3.83	4.00	TL14AM7-400PL	TL14AM7-400PM
6"	3.00	5.78	6.00	TL14AM7-600PL	TL14AM7-600PM

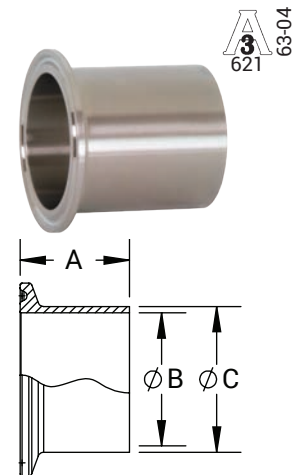

## Tank Ferrules (light duty) - 14WLMP

Tube O.D.	A (in)	B (in)	C (in)	304 Stainless Steel Part #	316L Stainless Steel Part #
1"	3.00	.87	1.00	14WLMP-G100	14WLMP-R100
1-1/2"	3.00	1.37	1.50	14WLMP-G150	14WLMP-R150
2"	3.00	1.87	2.00	14WLMP-G200	14WLMP-R200
2-1/2"	3.00	2.37	2.50	14WLMP-G250	14WLMP-R250
3"	4.00	2.87	3.00	14WLMP-G300	14WLMP-R300
4"	4.00	3.83	4.00	14WLMP-G400	14WLMP-R400
6"	6.00	5.78	6.00	14WLMP-G600	14WLMP-R600
8"	6.00	7.78	8.00	14WLMP-G800	14WLMP-R800
10"	6.00	9.76	10.00	---	14WLMP-R1000
12"	6.00	11.76	12.00	---	14WLMP-R1200

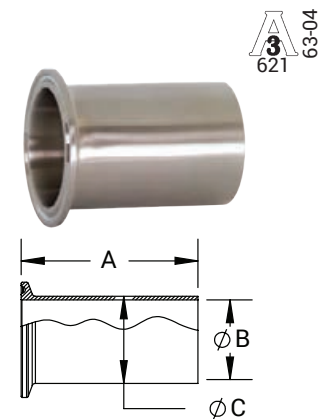

## Tank Ferrules (heavy duty) - 14MPW

Tube O.D.	A (in)	B (in)	C (in)	316L Stainless Steel Part #
1/2"	1.63	.32	.50	14MPW-R50
3/4"	1.63	.57	.75	14MPW-R75
1"	1.63	.87	1.16	14MPW-R100
1-1/2"	1.63	1.37	1.68	14MPW-R150
2"	1.75	1.87	2.19	14MPW-R200
2-1/2"	1.75	2.37	2.71	14MPW-R250
3"	1.81	2.87	3.22	14MPW-R300
4"	2.13	3.83	4.26	14MPW-R400
6"	2.50	5.76	6.19	14MPW-R600
8"	2.50	7.76	8.19	14MPW-R800

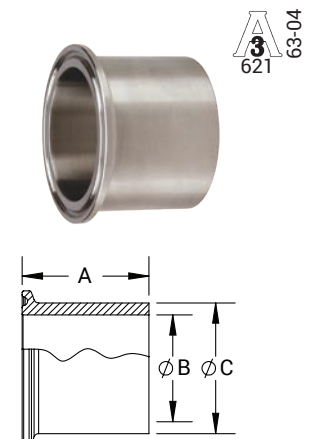

Clamp Fittings - Elbows

3 63-04  
621



90° Clamp Elbows - B2CMP

Tube O.D.	A (in)	R (in)	304 Stainless Steel Part #	316L Stainless Steel Part #
1/2"	1.63	1.13	---	B2CMP-R50
3/4"	1.63	1.13	---	B2CMP-R75
1/2"	3.50	1.13	---	B2CMPL-R50
3/4"	3.50	1.13	---	B2CMPL-R75
1"	2.00	1.50	B2CMP-G100	B2CMP-R100
1-1/2"	2.75	2.25	B2CMP-G150	B2CMP-R150
2"	3.50	3.00	B2CMP-G200	B2CMP-R200
2-1/2"	4.25	3.75	B2CMP-G250	B2CMP-R250
3"	5.00	4.50	B2CMP-G300	B2CMP-R300
4"	6.63	6.00	B2CMP-G400	B2CMP-R400
6"	9.88	9.00	B2CMP-G600	B2CMP-R600
8"	12.88	12.00	B2CMP-G800	B2CMP-R800
10"	15.88	15.00	B2CMP-G1000	---
12"	18.88	18.00	B2CMP-G1200	---

3 63-04  
621

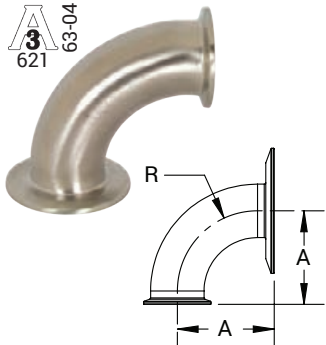

90° Non-Tapered Reducing Clamp Elbows - B2CM31MP

Tube O.D.	A (in)	R (in)	304 Stainless Steel Part #	316L Stainless Steel Part #
2" x 1-1/2"	2.75	2.25	B2CM31MPG200150	B2CM31MPR200150
2-1/2" x 2"	3.50	3.00	B2CM31MPG250200	B2CM31MPR250200
3" x 2"	3.50	3.00	B2CM31MPG300200	B2CM31MPR300200
3" x 2-1/2"	4.25	3.75	B2CM31MPG300250	B2CM31MPR300250

45° Clamp Elbows - B2KMP

3 63-04  
621

M

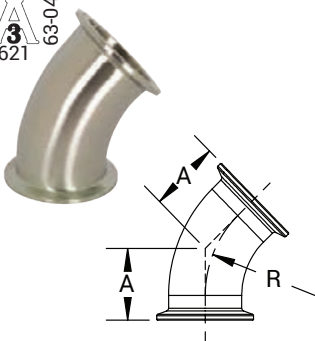

Tube O.D.	A (in)	R (in)	304 Stainless Steel Part #	316L Stainless Steel Part #
1/2"	.97	1.13	---	B2KMP-R50
3/4"	.97	1.13	---	B2KMP-R75
1"	1.12	1.50	B2KMP-G100	B2KMP-R100
1-1/2"	1.44	2.25	B2KMP-G150	B2KMP-R150
2"	1.75	3.00	B2KMP-G200	B2KMP-R200
2-1/2"	2.06	3.75	B2KMP-G250	B2KMP-R250
3"	2.37	4.50	B2KMP-G300	B2KMP-R300
4"	3.13	6.00	B2KMP-G400	B2KMP-R400
6"	4.63	9.00	B2KMP-G600	B2KMP-R600
8"	5.85	12.00	B2KMP-G800	B2KMP-R800
10"	7.13	15.00	B2KMP-G1000	---
12"	8.38	18.00	B2KMP-G1200	---

3 63-04  
621

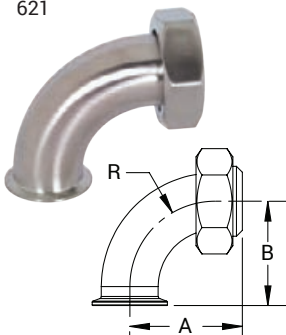

90° Clamp x Plain Bevel Seat with Hex Nut Elbows - B2FMP-14

Tube O.D.	A (in)	B (in)	R (in)	304 Stainless Steel Part #
1"	2.22	2.00	1.50	B2FMP-14-G100
1-1/2"	2.97	2.75	2.25	B2FMP-14-G150
2"	3.75	3.50	3.00	B2FMP-14-G200
2-1/2"	4.63	4.25	3.75	B2FMP-14-G250
3"	5.41	5.00	4.50	B2FMP-14-G300
4"	7.03	6.63	6.00	B2FMP-14-G400

### Clamp Sweep Elbows

**Feature**

- Standard with no tangents. Call Dixon Sanitary 800.789.1718 for tangents, 45°, and other radii

#### 12" 90° Clamp Sweep Elbows - B2SXLMP



Tube O.D.	A (in)	R (in)	316L Stainless Steel Part #
1-1/2"	12.00	12.00	B2SXLMP12-R150
2"			B2SXLMP12-R200
2-1/2"			B2SXLMP12-R250
3"			B2SXLMP12-R300
4"			B2SXLMP12-R400

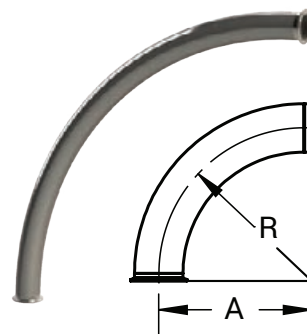

#### 18" 90° Clamp Sweep Elbows - B2SXLMP



Tube O.D.	A (in)	R (in)	316L Stainless Steel Part #
1-1/2"	18.00	18.00	B2SXLMP18-R150
2"			B2SXLMP18-R200
2-1/2"			B2SXLMP18-R250
3"			B2SXLMP18-R300
4"			B2SXLMP18-R400

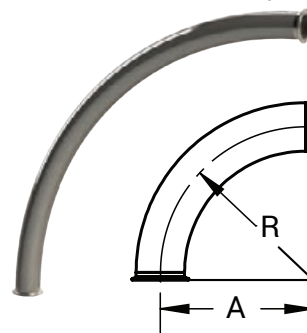

#### 24" 90° Clamp Sweep Elbows - B2SXLMP



Tube O.D.	A (in)	R (in)	316L Stainless Steel Part #
1-1/2"	24.00	24.00	B2SXLMP24-R150
2"			B2SXLMP24-R200
2-1/2"			B2SXLMP24-R250
3"			B2SXLMP24-R300
4"			B2SXLMP24-R400

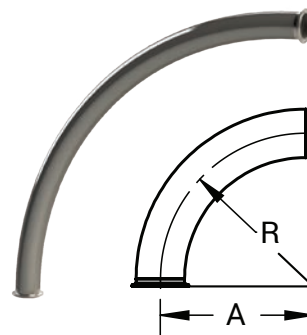

#### 36" 90° Clamp Sweep Elbows - B2SXLMP



Tube O.D.	A (in)	R (in)	316L Stainless Steel Part #
3"	36.00	36.00	B2SXLMP36-R300
4"			B2SXLMP36-R400
6"			B2SXLMP36-R600

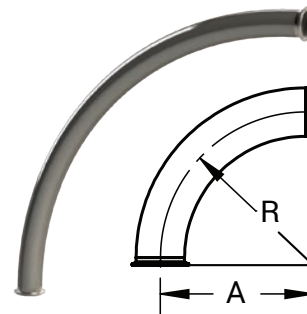

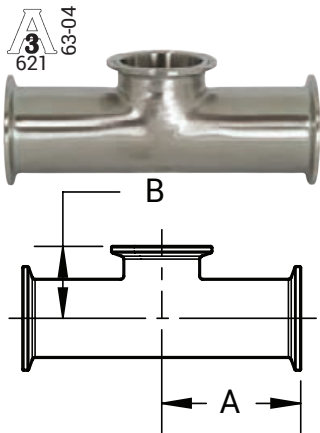

### Clamp Fittings - Tees

#### Short Outlet Tees - B7MPS

Tube O.D.	A (in)	B (in)	304 Stainless Steel Part #	316L Stainless Steel Part #
1"	2.38	1.13	B7MPS-G100	B7MPS-R100
1-1/2"	2.75	1.38	B7MPS-G150	B7MPS-R150
2"	3.50	1.63	B7MPS-G200	B7MPS-R200
2-1/2"	3.50	1.88	B7MPS-G250	B7MPS-R250
3"	3.75	2.13	B7MPS-G300	B7MPS-R300
4"	4.50	2.75	B7MPS-G400	B7MPS-R400

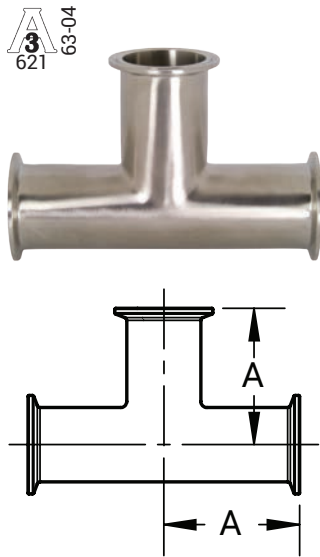

#### Clamp Tees - B7MP

Tube O.D.	A (in)	304 Stainless Steel Part #	316L Stainless Steel Part #
1/2"	2.38	---	B7MP-R50
3/4"	2.50	---	B7MP-R75
1"	2.38	B7MP-G100	B7MP-R100
1-1/2"	2.75	B7MP-G150	B7MP-R150
2"	3.50	B7MP-G200	B7MP-R200
2-1/2"	3.50	B7MP-G250	B7MP-R250
3"	3.75	B7MP-G300	B7MP-R300
4"	4.50	B7MP-G400	B7MP-R400
6"	6.50	B7MP-G600	B7MP-R600
8"	7.88	B7MP-G800	B7MP-R800
10"	9.38	B7MP-G1000	---
12"	10.88	B7MP-G1200	---

M

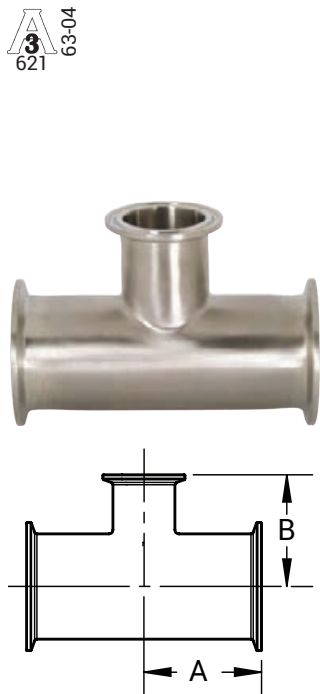

#### Clamp Reducing Tees - B7RMP

Tube O.D.	A (in)	B (in)	304 Stainless Steel Part #	316L Stainless Steel Part #
3/4" x 1/2"	2.50	2.50	---	B7RMP-R7550
1" x 1/2"	2.63	2.63	---	B7RMP-R10050
1" x 3/4"	2.63	2.63	---	B7RMP-R10075
1-1/2" x 1/2"	2.88	2.88	---	B7RMP-R15050
1-1/2" x 3/4"	2.88	2.88	---	B7RMP-R15075
1-1/2" x 1"	2.16	1.88	B7RMP-G150100	B7RMP-R150100
2" x 1/2"	3.38	3.13	---	B7RMP-R20050
2" x 3/4"	3.38	3.13	---	B7RMP-R20075
2" x 1"	2.56	2.13	B7RMP-G200100	B7RMP-R200100
2" x 1-1/2"	2.56	2.41	B7RMP-G200150	B7RMP-R200150
2-1/2" x 1-1/2"	2.84	2.66	B7RMP-G250150	B7RMP-R250150
2-1/2" x 2"	2.84	2.81	B7RMP-G250200	B7RMP-R250200
3" x 1-1/2"	3.09	2.91	B7RMP-G300150	B7RMP-R300150
3" x 2"	3.09	3.06	B7RMP-G300200	B7RMP-R300200
3" x 2-1/2"	3.09	3.09	B7RMP-G300250	B7RMP-R300250
4" x 1-1/2"	4.06	3.41	B7RMP-G400150	B7RMP-R400150
4" x 2"	4.06	3.56	B7RMP-G400200	B7RMP-R400200
4" x 2-1/2"	4.06	3.59	B7RMP-G400250	B7RMP-R400250
4" x 3"	4.06	3.59	B7RMP-G400300	B7RMP-R400300

## Clamp Reducers

## Clamp Concentric Reducers - B3114MP

  
63-04

Tube O.D.	A (in)	304 Stainless Steel Part #	316L Stainless Steel Part #
3/4" x 1/2"	2.00	---	B3114MP-R7550
1" x 1/2"	3.00	---	B3114MP-R10050
1" x 3/4"	2.00	---	B3114MP-R10075
1-1/2" x 1/2"	5.00	---	B3114MP-R15050
1-1/2" x 3/4"	4.00	---	B3114MP-R15075
1-1/2" x 1"	3.00	B3114MP-G150100	B3114MP-R150100
2" x 1/2"	7.00	---	B3114MP-R20050
2" x 3/4"	6.00	---	B3114MP-R20075
2" x 1"	5.00	B3114MP-G200100	B3114MP-R200100
2" x 1-1/2"	3.00	B3114MP-G200150	B3114MP-R200150
2-1/2" x 1-1/2"	5.00	B3114MP-G250150	B3114MP-R250150
2-1/2" x 2"	3.00	B3114MP-G250200	B3114MP-R250200
3" x 1"	9.00	B3114MP-G300100	B3114MP-R300100
3" x 1-1/2"	7.00	B3114MP-G300150	B3114MP-R300150
3" x 2"	5.00	B3114MP-G300200	B3114MP-R300200
3" x 2-1/2"	3.00	B3114MP-G300250	B3114MP-R300250
4" x 1-1/2"	11.13	B3114MP-G400150	B3114MP-R400150
4" x 2"	9.13	B3114MP-G400200	B3114MP-R400200
4" x 2-1/2"	7.13	B3114MP-G400250	B3114MP-R400250
4" x 3"	5.13	B3114MP-G400300	B3114MP-R400300
6" x 2"	6.88	B3114MP-G600200	B3114MP-R600200
6" x 3"	6.88	B3114MP-G600300	B3114MP-R600300
6" x 4"	7.00	B3114MP-G600400	B3114MP-R600400
8" x 4"	7.50	B3114MP-G800400	B3114MP-R800400
8" x 6"	7.75	B3114MP-G800600	B3114MP-R800600

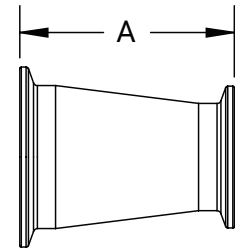

M

## Plain Bevel Seat x Clamp Concentric Reducers - B14C31

  
63-04

Tube O.D.	A (in)	304 Stainless Steel Part #
1-1/2" x 1"	3.22	B14C31-G150100 <sup>1</sup>
2" x 1-1/2"	3.25	B14C31-G200150
2-1/2" x 1-1/2"	5.38	B14C31-G250150
2-1/2" x 2"	3.38	B14C31-G250200
3" x 1-1/2"	7.41	B14C31-G300150
3" x 2"	5.41	B14C31-G300200
3" x 2-1/2"	3.41	B14C31-G300250

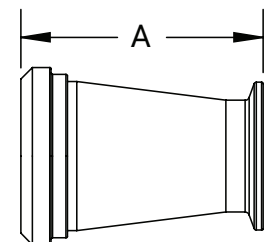

<sup>1</sup> Comes with 13H-G150, hex nut cannot be assembled on fitting after welding

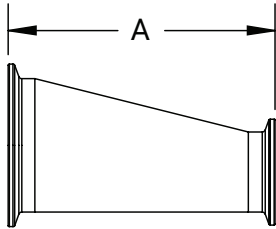

### Clamp Reducers

#### Clamp Eccentric Reducers - B3214MP

Tube O.D.	A (in)	304 Stainless Steel Part #	316L Stainless Steel Part #
3/4" x 1/2"	2.00	---	B3214MP-R7550
1" x 1/2"	3.00	---	B3214MP-R10050
1" x 3/4"	2.00	---	B3214MP-R10075
1-1/2" x 1/2"	5.00	---	B3214MP-R15050
1-1/2" x 3/4"	4.00	---	B3214MP-R15075
1-1/2" x 1"	3.00	B3214MP-G150100	B3214MP-R150100
2" x 1/2"	7.00	---	B3214MP-R20050
2" X 3/4"	6.00	---	B3214MP-R20075
2" x 1"	5.00	B3214MP-G200100	B3214MP-R200100
2" x 1-1/2"	3.00	B3214MP-G200150	B3214MP-R200150
2-1/2" x 1-1/2"	5.00	B3214MP-G250150	B3214MP-R250150
2-1/2" x 2"	3.00	B3214MP-G250200	B3214MP-R250200
3" x 1"	9.00	B3214MP-G300100	B3214MP-R300100
3" x 1-1/2"	7.00	B3214MP-G300150	B3214MP-R300150
3" x 2"	5.00	B3214MP-G300200	B3214MP-R300200
3" x 2-1/2"	3.00	B3214MP-G300250	B3214MP-R300250
4" x 1-1/2"	11.13	B3214MP-G400150	B3214MP-R400150
4" x 2"	9.13	B3214MP-G400200	B3214MP-R400200
4" x 2-1/2"	7.13	B3214MP-G400250	B3214MP-R400250
4" x 3"	5.13	B3214MP-G400300	B3214MP-R400300
6" x 3"	6.88	B3214MP-G600300	B3214MP-R600300
6" x 4"	7.00	B3214MP-G600400	B3214MP-R600400
8" x 4"	7.50	B3214MP-G800400	B3214MP-R800400
8" x 6"	7.75	B3214MP-G800600	B3214MP-R800600



## Clamp Fittings - Caps

## Solid End Caps - 16AMP

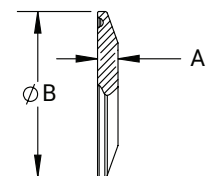

  
63-04

Tube O.D.	A (in)	B (in)	304 Stainless Steel Part #	316L Stainless Steel Part #
1/2" - 3/4"	.25	.99	16AMP-G50-75	16AMP-R50-75
1" - 1-1/2"	.25	1.98	16AMP-G100-150	16AMP-R100-150
2" - 2-1/2"	.25	2.52	16AMP-G200	16AMP-R200
2.5"	.25	3.05	16AMP-G250	16AMP-R250
3"	.25	3.58	16AMP-G300	16AMP-R300
4"	.31	4.68	16AMP-G400	16AMP-R400
5"	.38	5.69	16AMP-G500	16AMP-R500
6"	.44	6.56	16AMP-G600	16AMP-R600
8"	.44	8.60	16AMP-G800	16AMP-R800
10"	.44	1.57	16AMP-G1000	16AMP-R1000
12"	.44	12.57	16AMP-G1200	16AMP-R1200

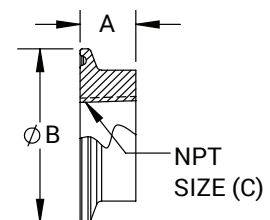

## Thermometer Caps - B23BMP

Tube O.D.	A (in)	B (in)	C <sup>1</sup> (in)	304 Stainless Steel Part #	316L Stainless Steel Part #
1/2"	.50	.99	1/4"	--	B23BMP-R5014
3/4"	.50	.99	1/4"	--	B23BMP-R7514
1"	.63	1.98	3/4"	B23BMP-G100	B23BMP-R100
1-1/2"	.63	1.98	1/4"	--	B23BMP-R15025
	.63	1.98	1/2"	B23BMP-G15050	B23BMP-R15050
	.63	1.98	3/4"	B23BMP-G150	B23BMP-R150
2"	.63	2.52	1/4"	--	B23BMP-R20025
	.63	2.52	1/2"	B23BMP-G20050	B23BMP-R20050
	.63	2.52	3/4"	B23BMP-G200	B23BMP-R200
	.63	2.52	1"	--	B23BMP-R200100
2-1/2"	.63	2.52	1-1/2"	--	B23BMP-R200150
	.63	3.05	3/4"	B23BMP-G250	B23BMP-R250
3"	.63	3.58	1/4"	B23BMP-G30025	B23BMP-R30025
	.63	3.58	1/2"	B23BMP-G30050	B23BMP-R30050
	.63	3.58	3/4"	B23BMP-G300	B23BMP-R300
	.63	3.58	1"	B23BMP-G300100	B23BMP-R300100
4"	.63	3.58	2"	B23BMP-G300200	B23BMP-R300200
	.63	4.68	3/4"	B23BMP-G400	B23BMP-R400



<sup>1</sup>Other NPT tap sizes available; call Dixon Sanitary at 800.789.1718.

Clamp Adapters

3A  
621 63-04

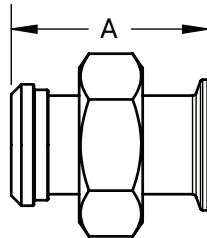

Clamp x Plain Bevel Seat Adapters with Hex Nut - 17MP-14

Tube O.D.	A (in)	304 Stainless Steel Part #
1"	3.00	17MP-14-G100
1-1/2"	3.00	17MP-14-G150
2"	3.00	17MP-14-G200
2-1/2"	3.50	17MP-14-G250
3"	3.75	17MP-14-G300
4"	4.00	17MP-14-G400

3A  
621 63-04

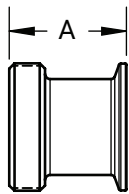

Clamp x Threaded Bevel Seat Adapters - 17MP-15

Tube O.D.	A (in)	304 Stainless Steel Part #
1"	1.84	17MP-15-G100
1-1/2"	1.84	17MP-15-G150
2"	1.88	17MP-15-G200
2-1/2"	2.00	17MP-15-G250
3"	2.03	17MP-15-G300
4"	2.16	17MP-15-G400

M

Tygon® Hose Adapters - 14MPHT

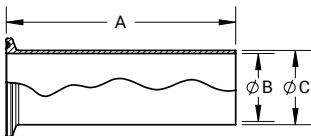

Tube O.D.	A (in)	B (in)	C (in)	316L Stainless Steel Part #
1/2"	4.00	.37	.50	14MPHT-R50
3/4"	4.00	.62	.75	14MPHT-R75
1"	4.50	.87	1.00	14MPHT-R100
1-1/2"	4.50	1.37	1.50	14MPHT-R150
2"	4.50	1.87	2.00	14MPHT-R200
2-1/2"	4.50	2.37	2.50	14MPHT-R250
3"	4.50	2.87	3.00	14MPHT-R300
4"	4.63	3.83	4.00	14MPHT-R400
6"	6.00	5.88	6.00	14MPHT-R600

1. Make sure the I.D. of the hose is slightly bigger than the O.D. of the fitting.
2. Insert 14MPHT fitting into the I.D. of the hose, so that the hose is 1/2" away from the clamp connection.
3. Use a band clamp to secure the hose to the 14MPHT.

NOTE: 3A certification is for fitting alone. The fitting attached to a hose does not retain the 3A certification nor does it make the hose assembly 3A certified.

## Clamp Fittings - Adapters

### Rubber Hose Adapters - 14MPHR

Tube O.D.	Hose Size	A (in)	B (in)	304 Stainless Steel Part #	316L Stainless Steel Part #
1/2"	1/8"	1.25	.15	--	14MPHR-R50125
	1/4"	1.50	.29	--	14MPHR-R5025
	3/8"	1.50	.42	--	14MPHR-R50375
	1/2"	1.50	.54	--	14MPHR-R50
	3/4"	1.50	.79	--	14MPHR-R5075
3/4"	1/8"	1.50	.15	--	14MPHR-R75125
	1/4"	1.50	.29	--	14MPHR-R7525
	3/8"	1.50	.42	--	14MPHR-R75375
	1/2"	1.50	.54	--	14MPHR-R7550
	3/4"	1.50	.79	--	14MPHR-R75
1"	5/8"	1.50	.67	--	14MPHR-R75625
	1/4"	1.69	.29	--	14MPHR-R10025
	3/8"	1.50	.42	14MPHR-G100375	14MPHR-R100375
	1/2"	1.50	.54	14MPHR-G10050	14MPHR-R10050
	3/4"	1.69	.79	14MPHR-G10075	14MPHR-R10075
1-1/2"	1"	1.69	1.04	14MPHR-R100	14MPHR-R100
	1/8"	1.50	.17	14MPHR-G150125	14MPHR-R150125
	1/4"	1.50	.29	--	14MPHR-R15025
	3/8"	1.50	.42	14MPHR-G150375	14MPHR-R150375
	1/2"	1.50	.54	14MPHR-G15050	14MPHR-R15050
	5/8"	1.50	.79	14MPHR-G150625	14MPHR-R150625
	3/4"	1.50	.67	14MPHR-G15075	14MPHR-R15075
	1"	1.69	1.04	14MPHR-G150100	14MPHR-R150100
2"	1-1/4"	1.69	1.29	--	14MPHR-R150-125
	1-1/2"	1.69	1.54	14MPHR-G150	14MPHR-R150
	1/8"	2.31	.17	14MPHR-G200125	14MPHR-R200125
	1/2"	2.31	.54	--	14MPHR-R20050
	5/8"	2.31	.67	14MPHR-G200625	--
	3/4"	2.31	.79	14MPHR-G20075	14MPHR-R20075
2-1/2"	1"	2.31	1.04	14MPHR-G200100	--
	1-1/2"	2.31	1.54	14MPHR-G200150	14MPHR-R200150
	2"	2.31	2.04	14MPHR-G200	14MPHR-R200
	1"	2.34	1.04	14MPHR-G250100	--
3"	2-1/2"	2.34	2.54	14MPHR-G250	14MPHR-R250
	3"	3.09	3.04	14MPHR-G300	14MPHR-R300
4"	3"	3.41	3.04	--	14MPHR-R400300
	4"	3.41	4.04	14MPHR-G400	14MPHR-R400
6"	6"	3.41	6.04	14MPHR-G600	14MPHR-R600
8"	8"	3.41	8.04	14MPHR-G800	14MPHR-R800
10"	10"	3.40	1.04	14MPHR-G1000	--

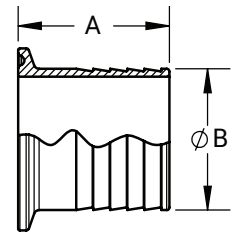

1. Make sure the I.D. of the hose is slightly bigger than the O.D. of the fitting.
2. Insert 14MPHR fitting into the I.D. of the hose, so that the hose is 1/2" away from the clamp connection.
3. Use a band clamp to secure the hose to the 14MPHR.

### Brewery Hose Barb Adapters - 14MPHRL

#### Application

- Suitable for use with band clamps

Size	A (in)	B (in)	304 Stainless Steel Part #
1/2"	3.35	.53	14MPHRL50
3/4"	3.35	.81	14MPHRL75
1"	3.50	1.05	14MPHRL100
1-1/2"	5.00	1.55	14MPHRL150
2"	5.00	2.05	14MPHRL200
2-1/2"	5.50	2.55	14MPHRL250
3"	5.50	3.05	14MPHRL300
4"	5.50	4.05	14MPHRL400
6"	5.50	6.05	14MPHRL600

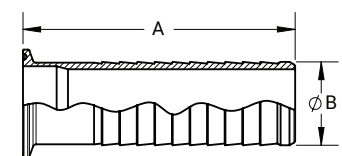

NOTE: Use of PVC tubing requires special techniques to prevent leakage. All assembly work must be done with heated tube. Cold durometer is 90 as opposed to rubber hose at 65 to 70 durometer. Banding buckles must be at 180° from one another.



**Clamp Fittings - Adapters**  
Male NPT Adapters - 21MP

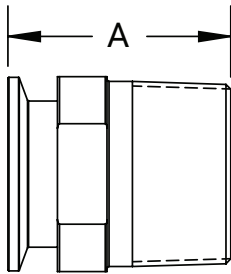

Tube O.D.	NPT Size	A (in)	304 Stainless Steel Part #	316L Stainless Steel Part #
1/2"	1/8"	2.00	--	21MP-R50125
	1/4"	2.00	--	21MP-R5025
	3/8"	2.00	--	21MP-R50375
	1/2"	1.63	--	21MP-R50
	3/4"	2.00	--	21MP-R5075
3/4"	1/4"	2.00	--	21MP-R7525
	3/8"	2.00	--	21MP-R75375
	1/2"	2.00	--	21MP-R7550
	3/4"	1.79	--	21MP-R75
1"	1"	2.25	--	21MP-R75100
	1/8"	2.19	21MP-G100-125	21MP-R100-125
	1/4"	2.16	21MP-G10025	21MP-R10025
	3/8"	2.16	21MP-G100375	21MP-R100375
	1/2"	2.19	21MP-G10050	21MP-R10050
	3/4"	2.19	21MP-G10075	21MP-R10075
	1"	2.25	21MP-G100	21MP-R100
	1-1/4"	2.44	21MP-G100125	21MP-R100125
	1-1/2"	2.44	21MP-G100150	21MP-R100150
	2"	2.63	21MP-G100200	21MP-R100200
1-1/2"	1/4"	2.16	21MP-G15025	21MP-R15025
	3/8"	2.16	21MP-G150375	21MP-R150375
	1/2"	2.19	21MP-G15050	21MP-R15050
	3/4"	2.19	21MP-G15075	21MP-R15075
	1"	2.44	21MP-G150100	21MP-R150100
	1-1/4"	2.44	21MP-G150125	21MP-R150125
	1-1/2"	2.25	21MP-G150	21MP-R150
	2"	2.63	21MP-G150200	21MP-R150200
	2-1/2"	3.28	21MP-G150250	21MP-R150250
2"	1/4"	2.47	--	21MP-R20025
	1/2"	2.19	21MP-G20050	21MP-R20050
	3/4"	2.19	21MP-G20075	21MP-R20075
	1"	2.47	21MP-G200100	21MP-R200100
	1-1/4"	2.47	21MP-G200125	21MP-R200125
	1-1/2"	2.63	21MP-G200150	21MP-R200150
	2"	2.64	21MP-G200	21MP-R200
	2-1/2"	3.13	21MP-G200250	21MP-R200250
	3"	3.50	21MP-G200300	21MP-R200300
2-1/2"	4"	3.50	21MP-G200400	21MP-R200400
	1/2"	2.78	21MP-G25050	21MP-R25050
	1"	2.78	21MP-G250100	21MP-R250100
	1-1/2"	2.78	21MP-G250150	21MP-R250150
	2"	2.78	21MP-G250200	21MP-R250200
	2-1/2"	2.88	21MP-G250	21MP-R250
3"	3"	3.69	21MP-G250300	21MP-R250300
	1"	3.00	21MP-G300100	21MP-R300100
	1-1/2"	3.00	21MP-G300150	21MP-R300150
	2"	3.00	21MP-G300200	21MP-R300200
	2-1/2"	3.00	21MP-G300250	21MP-R300250
	3"	3.07	21MP-G300	21MP-R300
4"	4"	3.50	21MP-G300400	21MP-R300400
	3"	3.81	21MP-G400300	21MP-R400300
6"	4"	3.16	21MP-G400	21MP-R400
	6"	4.50	21MP-G600	21MP-R600
8"	8"	3.75	21MP-G800	--

M

## Clamp Fittings - Adapters

### Female NPT Adapters - 22MP

Tube O.D.	NPT Size	A (in)	304 Stainless Steel Part #	316L Stainless Steel Part #
1/2"	1/8"	1.25	--	22MP-R50-125
	1/4"	1.50	--	22MP-R5025
	3/8"	1.50	--	22MP-R50375
	1/2"	1.50	--	22MP-R50
	3/4"	1.63	--	22MP-R5075
	1"	1.63	--	22MP-R50100
	1-1/2"	2.25	--	22MP-R50150
	2"	2.25	--	22MP-R50200
3/4"	1/8"	1.25	--	22MP-R75125
	1/4"	1.50	--	22MP-R7525
	3/8"	1.50	--	22MP-R75375
	1/2"	1.50	--	22MP-R7550
	3/4"	1.63	--	22MP-R75
	1"	1.63	--	22MP-R75100
1"	1/8"	1.63	22MP-G100-125	22MP-R100-125
	1/4"	1.63	22MP-G10025	22MP-R10025
	3/8"	1.63	22MP-G100375	22MP-R100375
	1/2"	1.63	22MP-G10050	22MP-R10050
	3/4"	1.63	22MP-G10075	22MP-R10075
	1"	1.63	22MP-G100	22MP-R100
	1-1/4"	1.63	22MP-G100125	22MP-R100125
	1-1/2"	1.63	22MP-G100150	22MP-R100150
	2"	1.63	22MP-G100200	22MP-R100200
	1-1/2"	1/8"	1.63	22MP-G150-125
1/4"		1.63	22MP-G15025	22MP-R15025
3/8"		1.63	22MP-G150375	22MP-R150375
1/2"		1.63	22MP-G15050	22MP-R15050
3/4"		1.63	22MP-G15075	22MP-R15075
1"		1.63	22MP-G150100	22MP-R150100
1-1/4"		2.25	22MP-G150125	22MP-R150125
1-1/2"		2.25	22MP-G150	22MP-R150
2"		2.25	22MP-G150200	22MP-R150200
2-1/2"		2.50	22MP-G150250	--
3"		2.50	--	22MP-R150300
2"	1/4"	1.69	22MP-G20025	22MP-R20025
	1/2"	1.69	22MP-G20050	22MP-R20050
	3/4"	1.69	22MP-G20075	22MP-R20075
	1"	1.69	22MP-G200100	22MP-R200100
	1-1/4"	1.69	22MP-G200125	22MP-R200125
	1-1/2"	1.66	22MP-G200150	22MP-R200150
	2"	2.34	22MP-G200	22MP-R200
	2-1/2"	2.41	22MP-G200250	22MP-R200250
	3"	2.41	22MP-G200300	22MP-R200300
	4"	2.91	22MP-G200400	--
2-1/2"	3/4"	1.31	22MP-G25075	22MP-R25075
	1"	1.31	22MP-G250100	22MP-R250100
	1-1/2"	1.66	22MP-G250150	22MP-R250150
	2"	1.72	22MP-G250200	22MP-R250200
	2-1/2"	2.09	22MP-G250	22MP-R250
	3"	2.19	22MP-G250300	22MP-R250300
3"	1"	2.19	22MP-G300100	22MP-R300100
	1-1/2"	2.19	22MP-G300150	22MP-R300150
	2"	2.19	22MP-G300200	22MP-R300200
	2-1/2"	2.19	22MP-G300250	--
	3"	2.19	22MP-G300	22MP-R300
4"	1-1/2"	2.19	22MP-G400150	22MP-R400150
	2"	2.19	22MP-G400200	22MP-R400200
	2-1/2"	2.19	22MP-G400250	22MP-R400250
	3"	2.19	22MP-G400300	22MP-R400300
	4"	2.63	22MP-G400	22MP-R400
	6"	3.25	22MP-G400600	22MP-R400600

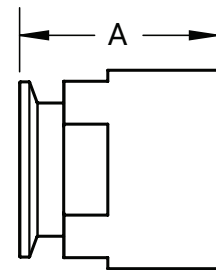

Laterals, Wyes, Crosses, Bends, and Flanges

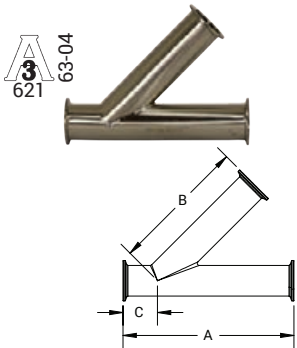

Clamp Laterals - B28AMP

Tube O.D.	A (in)	B (in)	C (in)	316L Stainless Steel Part #
1"	7.00	5.50	1.50	B28AMP-R100
1-1/2"	8.38	6.69	1.69	B28AMP-R150
2"	9.75	7.63	2.13	B28AMP-R200
2-1/2"	11.00	9.00	2.00	B28AMP-R250
3"	11.75	9.38	2.38	B28AMP-R300
4"	14.06	11.31	2.64	B28AMP-R400
6"	19.75	15.38	4.38	B28AMP-R600

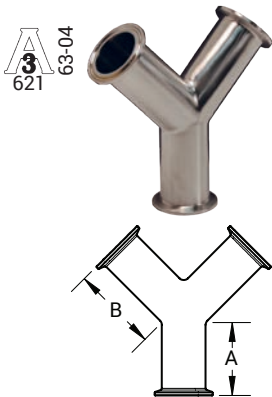

Clamp True Wyes - B28BMP

Tube O.D.	A (in)	B (in)	316L Stainless Steel Part #
1"	2.50	2.94	B28BMP-R100
1-1/2"	2.50	2.94	B28BMP-R150
2"	3.13	3.75	B28BMP-R200
2-1/2"	3.87	4.63	B28BMP-R250
3"	4.50	5.38	B28BMP-R300
4"	6.00	6.00	B28BMP-R400
6"	3.12	7.62	B28BMP-R600
8"	3.70	8.20	B28BMP-R800

M

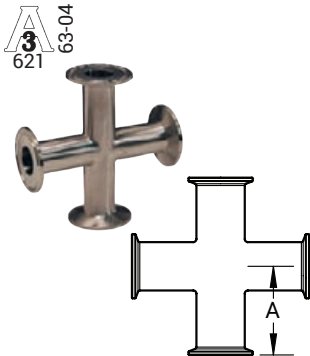

Clamp Crosses - B9MP

Tube O.D.	A (in)	304 Stainless Steel Part #	316L Stainless Steel Part #
1"	2.38	B9MP-G100	B9MP-R100
1-1/2"	2.75	B9MP-G150	B9MP-R150
2"	3.50	B9MP-G200	B9MP-R200
2-1/2"	3.50	B9MP-G250	B9MP-R250
3"	3.75	B9MP-G300	B9MP-R300
4"	4.50	B9MP-G400	B9MP-R400

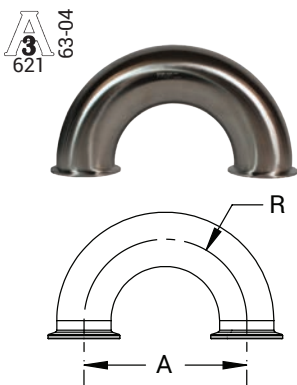

Clamp 180° Return Bends - B2WUMP

Feature

- Bends are 1.5 x tube diameter

Tube O.D.	A (in)	R (in)	316L Stainless Steel Part #
1"	3.00	1.50	B2WUMP-R100
1-1/2"	4.50	2.25	B2WUMP-R150
2"	6.00	3.00	B2WUMP-R200
2-1/2"	7.50	3.75	B2WUMP-R250
3"	9.00	4.50	B2WUMP-R300
4"	12.00	6.00	B2WUMP-R400

## Laterals, Wyes, Crosses, Bends, and Flanges

### Clamp x 150# Flange Adapters - B38MP

Tube O.D.	A (in)	B (in)	C (in)	Number & Diameter Bolt Holes	Bolt Circle	316L Stainless Steel Part #
1"	3.13	.87	1.63	4/.625	3.125	B38MP-R100
1-1/2"	3.88	1.37	1.63	4/.625	3.875	B38MP-R150
2"	4.75	1.87	1.75	4/.750	4.750	B38MP-R200
2-1/2"	5.50	2.37	1.75	4/.750	5.500	B38MP-R250
3"	6.00	2.87	1.75	4/.750	6.000	B38MP-R300
4"	7.50	3.83	1.75	8/.750	7.500	B38MP-R400
6"	9.50	5.78	2.13	8/.750	9.500	B38MP-R600

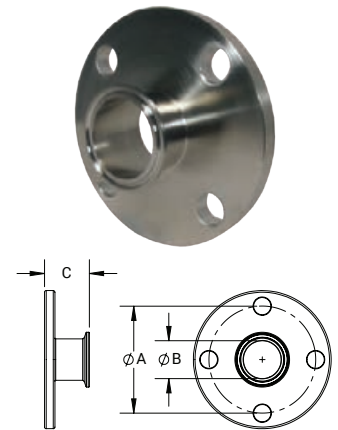

### Clamp End Protection Covers - BCC

#### Application

- Use these covers to protect all clamp ends on fittings, valves, filters, and pumps

Size	Vinyl Plastic Blue Part #	Vinyl Plastic Red Part #
1/2"	BCC-050	BCCR-050
3/4"	BCC-075	BCCR-075
1"	BCC-100	BCCR-100
1-1/2"	BCC-150	BCCR-150
2"	BCC-200	BCCR-200
2-1/2"	BCC-250	BCCR-250
3"	BCC-300	BCCR-300
4"	BCC-400	BCCR-400
6"	BCC-600	BCCR-600
8"	BCC-800	--

**M**



## Sanitary Spools

Sanitary spools are pre-fabricated lengths of stainless steel tubing with sanitary fittings welded to the ends.

### Applications

- Sanitary process lines can be built without having to use on-site fabrication or welding
- OEM skid packages that have predetermined spool specifications: Tube O.D. and length, end connections, and finish

### Sizes

- 1/2" - 8" tube O.D.

### Features

- Clamp connection, standard
- Will fabricate to customer drawings
- Customer part number/logo can be laser etched on each spool

### Materials

- 304 or 316L stainless steel
- Surface finish: 32Ra I.D./O.D., standard

### Primary Markets

- Found in the food processing, beverage, dairy, pet products, wineries and breweries, oil extraction, and industrial markets



Clamp End



Weld End

Size	Material	12" Part #	18" Part #	24" Part #	36" Part #	48" Part #
1-1/2"	304 stainless steel	S15CC012.000GC	S15CC018.000GC	S15CC024.000GC	S15CC036.000GC	S15CC048.000GC
2"		S20CC012.000GC	S20CC018.000GC	S20CC024.000GC	S20CC036.000GC	S20CC048.000GC
2-1/2"		S25CC012.000GC	S25CC018.000GC	S25CC024.000GC	S25CC036.000GC	S25CC048.000GC
3"		S30CC012.000GC	S30CC018.000GC	S30CC024.000GC	S30CC036.000GC	S30CC048.000GC
4"		S40CC012.000GC	S40CC018.000GC	S40CC024.000GC	S40CC036.000GC	S40CC048.000GC
1-1/2"	316L stainless steel	S15CC012.000RC	S15CC018.000RC	S15CC024.000RC	S15CC036.000RC	S15CC048.000RC
2"		S20CC012.000RC	S20CC018.000RC	S20CC024.000RC	S20CC036.000RC	S20CC048.000RC
2-1/2"		S25CC012.000RC	S25CC018.000RC	S25CC024.000RC	S25CC036.000RC	S25CC048.000RC
3"		S30CC012.000RC	S30CC018.000RC	S30CC024.000RC	S30CC036.000RC	S30CC048.000RC
4"		S40CC012.000RC	S40CC018.000RC	S40CC024.000RC	S40CC036.000RC	S40CC048.000RC

NOTE: All part numbers include clamp connections and #7 polish.  
For additional sizes and configurations, contact Dixon Sanitary 800.789.1718.

### Orbital Welding

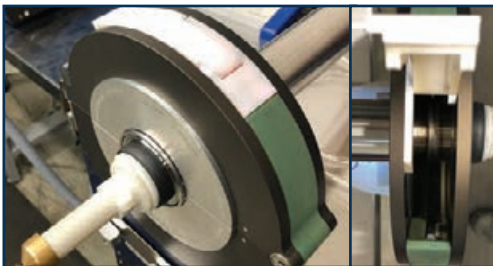

### Manufacturing Process

### Polishing



### Laser Etching



M



### Weld Elbows

#### 90° Weld Elbows with Tangents - B2S



Tube O.D.	A (in)	R (in)	Nominal Wall (in)	304 Stainless Steel Part #	316L Stainless Steel Part #
1/2"	3.00	1.13	.065	B2S-G50P	B2S-R50P
3/4"	3.00	1.13	.065	B2S-G75P	B2S-R75P
1"	2.06	1.50	.065	B2S-G100P	B2S-R100P
1-1/2"	2.94	2.25	.065	B2S-G150P	B2S-R150P
2"	4.06	3.00	.065	B2S-G200P	B2S-R200P
2-1/2"	5.19	3.75	.065	B2S-G250P	B2S-R250P
3"	6.31	4.50	.065	B2S-G300P	B2S-R300P
4"	8.31	6.00	.083	B2S-G400P	B2S-R400P
6"	12.46	9.00	.109	B2S-G600P	B2S-R600P

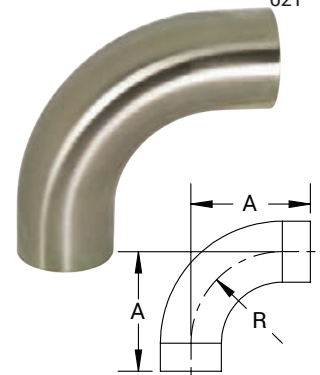

#### 90° Weld Elbows - B2WCL



Tube O.D.	A (in)	R (in)	Nominal Wall (in)	304 Stainless Steel Part #	316L Stainless Steel Part #
1/2"	1.13	1.13	.065	---	B2WCL-R50P
3/4"	1.13	1.13	.065	---	B2WCL-R75P
1"	1.50	1.50	.065	B2WCL-G100P	B2WCL-R100P
1-1/2"	2.25	2.25	.065	B2WCL-G150P	B2WCL-R150P
2"	3.00	3.00	.065	B2WCL-G200P	B2WCL-R200P
2-1/2"	3.75	3.75	.065	B2WCL-G250P	B2WCL-R250P
3"	4.50	4.50	.065	B2WCL-G300P	B2WCL-R300P
4"	6.00	6.00	.083	B2WCL-G400P	B2WCL-R400P
6"	9.00	9.00	.109	B2WCL-G600P	B2WCL-R600P
8"	12.00	12.00	.109	B2WCL-G800P	B2WCL-R800P
10"	15.00	15.00	.120	B2WCL-G1000P	B2WCL-R1000P
12"	18.00	18.00	.120	---	B2WCL-R1200P

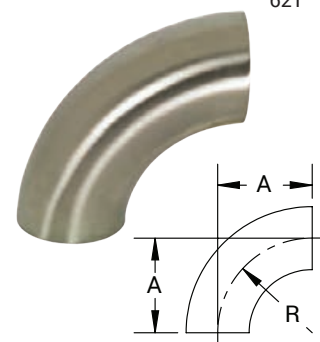

#### 45° Weld Elbows with Tangents - B2KS



Tube O.D.	A (in)	R (in)	Nominal Wall (in)	304 Stainless Steel Part #	316L Stainless Steel Part #
1/2"	2.25	1.13	.065	---	B2KS-R50P
3/4"	2.25	1.13	.065	---	B2KS-R75P
1"	1.19	1.50	.065	B2KS-G100P	B2KS-R100P
1-1/2"	1.63	2.25	.065	B2KS-G150P	B2KS-R150P
2"	2.31	3.00	.065	B2KS-G200P	B2KS-R200P
2-1/2"	3.00	3.75	.065	B2KS-G250P	B2KS-R250P
3"	3.69	4.50	.065	B2KS-G300P	B2KS-R300P
4"	4.81	6.00	.083	B2KS-G400P	B2KS-R400P

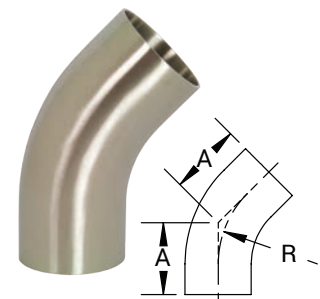

#### 45° Weld Elbows - B2WK



Tube O.D.	A (in)	R (in)	Nominal Wall (in)	304 Stainless Steel Part #	316L Stainless Steel Part #
1/2"	0.47	1.13	.065	---	B2WK-R50P
3/4"	0.47	1.13	.065	---	B2WK-R75P
1"	0.62	1.50	.065	B2WK-G100P	B2WK-R100P
1-1/2"	0.94	2.25	.065	B2WK-G150P	B2WK-R150P
2"	1.25	3.00	.065	B2WK-G200P	B2WK-R200P
2-1/2"	1.56	3.75	.065	B2WK-G250P	B2WK-R250P
3"	1.87	4.50	.065	B2WK-G300P	B2WK-R300P
4"	2.50	6.00	.083	B2WK-G400P	B2WK-R400P
6"	3.75	9.00	.109	B2WK-G600P	B2WK-R600P
8"	4.97	12.00	.109	B2WK-G800P	B2WK-R800P
10"	6.25	15.00	.120	B2WK-G1000P	B2WK-R1000P
12"	7.50	18.00	.120	B2WK-G1200P	B2WK-R1200P

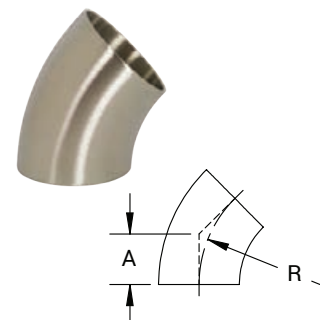

**Weld Elbows**

**90° Clamp x Weld Elbows - B2CM**

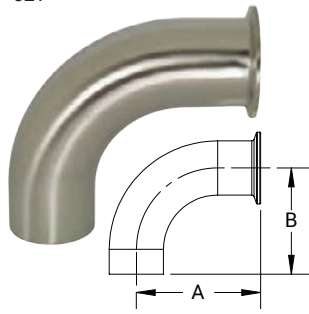

Tube O.D.	A (in)	B (in)	Nominal Wall (in)	304 Stainless Steel Part #	316L Stainless Steel Part #
1/2"	3.50	3.00	.065	--	B2CM-R50
3/4"	3.50	3.00	.065	--	B2CM-R75
1"	2.56	2.06	.065	B2CM-G100	B2CM-R100
1-1/2"	3.44	2.94	.065	B2CM-G150	B2CM-R150
2"	4.56	4.06	.065	B2CM-G200	B2CM-R200
2-1/2"	5.69	5.19	.065	B2CM-G250	B2CM-R250
3"	6.81	6.31	.065	B2CM-G300	B2CM-R300
4"	8.94	8.31	.083	B2CM-G400	B2CM-R400
6"	13.34	12.46	.109	--	B2CM-R600
8"	12.88	12.00	.109	--	B2CM-R800

**45° Clamp x Weld Elbows - B2KM**

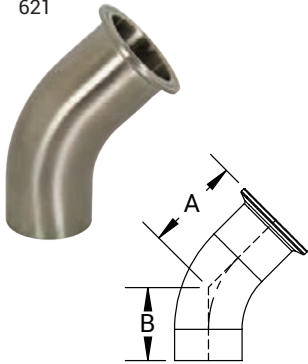

Tube O.D.	A (in)	B (in)	Nominal Wall (in)	304 Stainless Steel Part #	316L Stainless Steel Part #
1"	1.69	1.19	.065	B2KM-G100	B2KM-R100
1-1/2"	2.13	1.63	.065	B2KM-G150	B2KM-R150
2"	2.81	2.31	.065	B2KM-G200	B2KM-R200
2-1/2"	3.50	3.00	.065	B2KM-G250	B2KM-R250
3"	4.19	3.69	.065	B2KM-G300	B2KM-R300
4"	5.44	4.81	.083	B2KM-G400	B2KM-R400

**90° Threaded Bevel Seat x Weld Elbows - B2T**



**M**

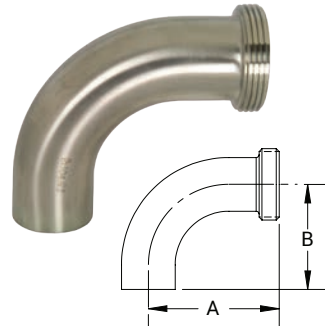

Tube O.D.	A (in)	B (in)	Nominal Wall (in)	304 Stainless Steel Part #
1"	2.78	2.06	.065	B2T-G100
1-1/2"	3.66	2.94	.065	B2T-G150
2"	4.81	4.06	.065	B2T-G200
2-1/2"	6.06	5.19	.065	B2T-G250
3"	7.22	6.31	.065	B2T-G300
4"	9.34	8.31	.083	B2T-G400

**90° Plain Bevel Seat with Hex Nut x Weld Elbows - B2FP**

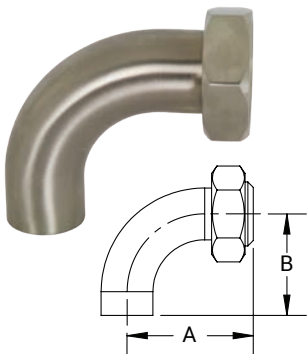

Tube O.D.	A (in)	B (in)	Nominal Wall (in)	304 Stainless Steel Part #
1"	2.78	2.06	.065	B2FP-G100
1-1/2"	3.66	2.94	.065	B2FP-G150
2"	4.81	4.06	.065	B2FP-G200
2-1/2"	6.06	5.19	.065	B2FP-G250
3"	7.22	6.31	.065	B2FP-G300
4"	9.34	8.31	.083	B2FP-G400

### Weld Sweep Elbows

**Feature**

- Standard with no tangents. Call Dixon Sanitary 800.789.1718 for tangents, 45°, and other radii

#### 12" 90° Weld Sweep Elbows - B2SXL

Tube O.D.	A (in)	R (in)	316L Stainless Steel Part #
1"	12.00	12.00	B2SXL12-R100
1-1/2"	12.00	12.00	B2SXL12-R150
2"	12.00	12.00	B2SXL12-R200
2-1/2"	12.00	12.00	B2SXL12-R250
3"	12.00	12.00	B2SXL12-R300
4"	12.00	12.00	B2SXL12-R400

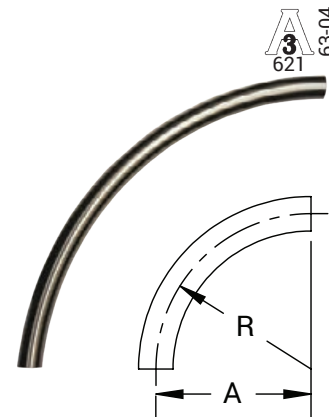

#### 18" 90° Weld Sweep Elbows - B2SXL

Tube O.D.	A (in)	R (in)	316L Stainless Steel Part #
1"	18.00	18.00	B2SXL18-R100
1-1/2"	18.00	18.00	B2SXL18-R150
2"	18.00	18.00	B2SXL18-R200
2-1/2"	18.00	18.00	B2SXL18-R250
3"	18.00	18.00	B2SXL18-R300
4"	18.00	18.00	B2SXL18-R400

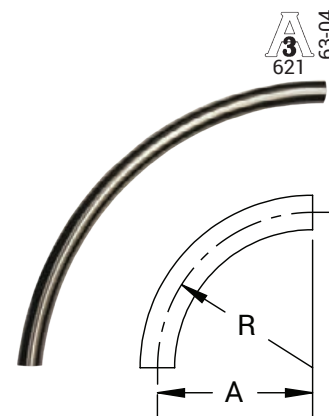

#### 24" 90° Weld Sweep Elbows - B2SXL

Tube O.D.	A (in)	R (in)	316L Stainless Steel Part #
1-1/2"	24.00	24.00	B2SXL24-R150
2"	24.00	24.00	B2SXL24-R200
2-1/2"	24.00	24.00	B2SXL24-R250
3"	24.00	24.00	B2SXL24-R300
4"	24.00	24.00	B2SXL24-R400
6"	24.00	24.00	B2SXL24-R600

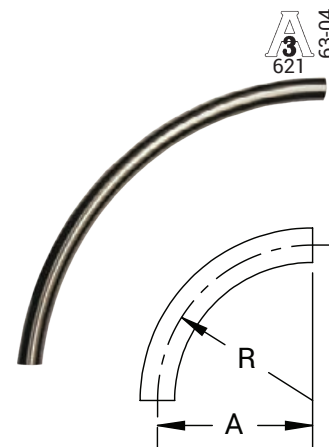

#### 36" 90° Weld Sweep Elbows - B2SXL

Tube O.D.	A (in)	R (in)	316L Stainless Steel Part #
1-1/2"	36.00	36.00	B2SXL36-R150
2"	36.00	36.00	B2SXL36-R200
2-1/2"	36.00	36.00	B2SXL36-R250
3"	36.00	36.00	B2SXL36-R300
4"	36.00	36.00	B2SXL36-R400
6"	36.00	36.00	B2SXL36-R600

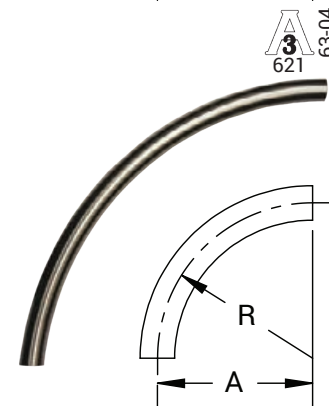

**M**

**Weld Tees**

**Short Weld Tees - B7WWW**

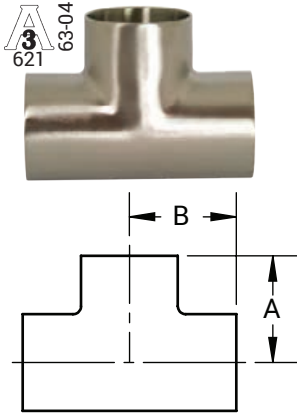

Tube O.D.	A (in)	B (in)	Nominal Wall (in)	304 Stainless Steel Part #	316L Stainless Steel Part #
3/4" x 1/2"	2.00	2.00	.065	--	B7WWW-R7550P
1" X 1/2"	2.13	2.13	.065	--	B7WWW-R100500P
1" X 3/4"	2.13	2.13	.065	--	B7WWW-R10075P
1-1/2" X 1/2"	2.38	2.38	.065	--	B7WWW-R15050P
1-1/2" X 3/4"	2.38	2.38	.065	--	B7WWW-R15075P
1-1/2" X 1"	2.38	2.38	.065	B7WWW-G150100P	B7WWW-R150100P
2" X 1"	2.88	2.63	.065	B7WWW-G200100P	B7WWW-R200100P
2" X 1-1/2"	2.88	2.63	.065	B7WWW-G200150P	B7WWW-R200150P
2-1/2" X 1"	2.34	1.88	.065	B7WWW-G250100P	B7WWW-R250100P
2-1/2" X 1-1/2"	3.13	2.88	.065	B7WWW-G250150P	B7WWW-R250150P
2-1/2" X 2"	3.13	2.88	.065	B7WWW-G250200P	B7WWW-R250200P
3" X 1"	2.59	2.13	.065	B7WWW-G300100P	B7WWW-R300100P
3" X 1-1/2"	3.38	3.13	.065	B7WWW-G300150P	B7WWW-R300150P
3" X 2"	3.38	3.13	.065	B7WWW-G300200P	B7WWW-R300200P
3" X 2-1/2"	3.38	3.13	.083	B7WWW-G300250P	B7WWW-R300250P
4" X 1"	3.44	2.91	.083	B7WWW-G400100P	B7WWW-R400100P
4" X 1-1/2"	4.13	3.63	.083	B7WWW-G400150P	B7WWW-R400150P
4" X 2"	4.13	3.88	.083	B7WWW-G400200P	B7WWW-R400200P
4" X 2-1/2"	4.13	3.88	.083	B7WWW-G400250P	B7WWW-R400250P
4" X 3"	4.13	3.88	.083	B7WWW-G400300P	B7WWW-R400300P
6" X 2"	5.63	4.50	.109	B7WWW-G600200P	B7WWW-R600200P
6" X 3"	5.63	4.88	.109	B7WWW-G600300P	B7WWW-R600300P
6" X 4"	5.63	5.13	.109	B7WWW-G600400P	B7WWW-R600400P

**Long Weld Tees - B7W**

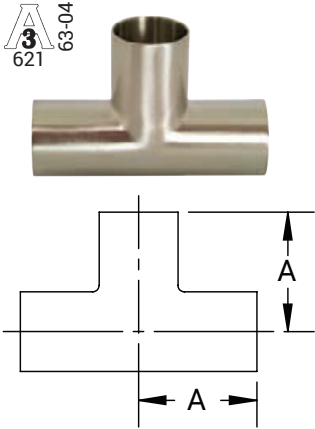

Tube O.D.	A (in)	Nominal Wall (in)	304 Stainless Steel Part #	316L Stainless Steel Part #
1/2"	1.88	.065	---	B7W-R50P
3/4"	2.00	.065	---	B7W-R75P
1"	1.88	.065	B7W-G100P	B7W-R100P
1-1/2"	2.25	.065	B7W-G150P	B7W-R150P
2"	3.00	.065	B7W-G200P	B7W-R200P
2-1/2"	3.00	.065	B7W-G250P	B7W-R250P
3"	3.25	.065	B7W-G300P	B7W-R300P
4"	3.88	.083	B7W-G400P	B7W-R400P
6"	5.63	.109	B7W-G600P	B7W-R600P
8"	7.00	.109	B7W-G800P	B7W-R800P

**Reducing Weld Tees - B7RWWW**

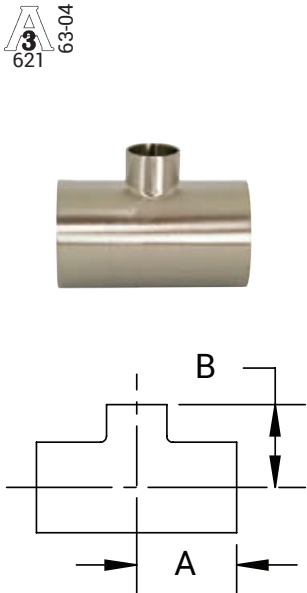

Tube O.D.	A (in)	B (in)	Nominal Wall (in)	304 Stainless Steel Part #	316L Stainless Steel Part #
3/4" x 1/2"	2.00	2.00	.065	---	B7RWWW-R7550P
1" x 1/2"	2.13	2.13	.065	---	B7RWWW-R10050P
1" x 3/4"	2.13	2.13	.065	---	B7RWWW-R10075P
1-1/2" x 1/2"	2.38	2.38	.065	---	B7RWWW-R15050P
1-1/2" x 3/4"	2.38	2.38	.065	---	B7RWWW-R15075P
1-1/2" x 1"	1.66	1.38	.065	B7RWWW-G150100P	B7RWWW-R150100P
2" x 1"	2.06	1.63	.065	B7RWWW-G200100P	B7RWWW-R200100P
2" x 1-1/2"	2.06	1.91	.065	B7RWWW-G200150P	B7RWWW-R200150P
2-1/2" x 1-1/2"	2.34	2.16	.065	B7RWWW-G250150P	B7RWWW-R250150P
2-1/2" x 2"	2.34	2.31	.065	B7RWWW-G250200P	B7RWWW-R250200P
3" x 1-1/2"	2.59	2.41	.065	B7RWWW-G300150P	B7RWWW-R300150P
3" x 2"	2.59	2.56	.065	B7RWWW-G300200P	B7RWWW-R300200P
3" x 2-1/2"	2.59	2.59	.083	B7RWWW-G300250P	B7RWWW-R300250P
4" x 1-1/2"	3.44	2.91	.083	B7RWWW-G400150P	B7RWWW-R400150P
4" x 2"	3.44	3.06	.083	B7RWWW-G400200P	B7RWWW-R400200P
4" x 2-1/2"	3.44	3.09	.083	B7RWWW-G400250P	B7RWWW-R400250P
4" x 3"	3.44	3.09	.083	B7RWWW-G400300P	B7RWWW-R400300P
6" x 2"	5.63	4.50	.109	B7RWWW-G600200P	B7RWWW-R600200P
6" x 3"	5.63	4.88	.109	B7RWWW-G600300P	B7RWWW-R600300P
6" x 4"	5.63	5.13	.109	B7RWWW-G600400P	B7RWWW-R600400P

## Weld Tees

### Weld Run x Clamp Branch Tees - B7WWM

Tube O.D.	A (in)	B (in)	Nominal Wall (in)	304 Stainless Steel Part #	316L Stainless Steel Part #
1/2"	1.88	2.38	.065	--	B7WWM-R50
3/4"	2	2.5	.065	--	B7WWM-R75
1"	1.13	1.63	.065	B7WWM-G100	B7WWM-R100
1-1/2"	1.66	2.16	.065	B7WWM-G150	B7WWM-R150
2"	2.06	2.56	.065	B7WWM-G200	B7WWM-R200
2-1/2"	2.34	2.84	.065	B7WWM-G250	B7WWM-R250
3"	2.59	3.09	.065	B7WWM-G300	B7WWM-R300
4"	3.44	4.06	.083	B7WWM-G400	B7WWM-R400



3  
621  
63-04

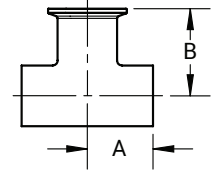

### Weld x Clamp Run x Clamp Branch Tees - B7WMM

Tube O.D.	A (in)	B (in)	Nominal Wall (in)	304 Stainless Steel Part #
1"	1.63	1.13	.065	B7WMM-G100
1-1/2"	2.16	1.66	.065	B7WMM-G150
2"	2.56	2.06	.065	B7WMM-G200
2-1/2"	2.84	2.34	.065	B7WMM-G250
3"	3.09	2.59	.065	B7WMM-G300
4"	4.06	3.44	.083	B7WMM-G400



3  
621  
63-04

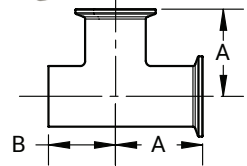

### Clamp Run x Weld Branch Tees - B7MMW

Tube O.D.	A (in)	B (in)	Nominal Wall (in)	304 Stainless Steel Part #
1"	1.63	1.13	.065	B7MMW-G100
1-1/2"	2.16	1.66	.065	B7MMW-G150
2"	2.56	2.06	.065	B7MMW-G200
2-1/2"	2.84	2.34	.065	B7MMW-G250
3"	3.09	2.59	.065	B7MMW-G300
4"	4.06	3.44	.083	B7MMW-G400



3  
621  
63-04

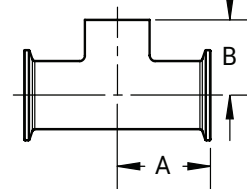

M

**Weld Reducers**

**Concentric Weld Reducers - B31W**

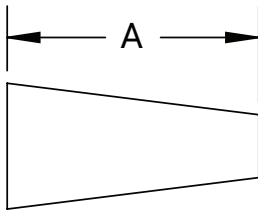
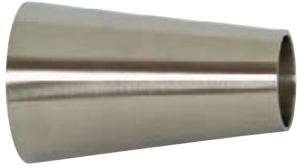

Tube O.D.	A (in)	Nominal Wall (in)	304 Stainless Steel Part #	316L Stainless Steel Part #
3/4" X 1/2"	1.00	.065	--	B31W-R7550P
1" X 1/2"	2.00	.065	--	B31W-R10050P
1" X 3/4"	1.00	.065	--	B31W-R10075P
1-1/2" X 1/2"	4.00	.065	--	B31W-R15050P
1-1/2" X 3/4"	3.00	.065	--	B31W-R15075P
1-1/2" X 1"	2.00	.065	B31W-G150100P	B31W-R150100P
2" X 1/2"	6.00	.065	--	B31W-R20050P
2" X 3/4"	5.00	.065	--	B31W-R20075P
2" X 1"	4.00	.065	B31W-G200100P	B31W-R200100P
2" X 1-1/2"	2.00	.065	B31W-G200150P	B31W-R200150P
2-1/2" X 1"	6.00	.065	B31W-G250100P	B31W-R250100P
2-1/2" X 1-1/2"	4.00	.065	B31W-G250150P	B31W-R250150P
2-1/2" X 2"	2.00	.065	B31W-G250200P	B31W-R250200P
3" X 1"	8.00	.065	B31W-G300100P	B31W-R300100P
3" X 1-1/2"	6.00	.065	B31W-G300150P	B31W-R300150P
3" X 2"	4.00	.065	B31W-G300200P	B31W-R300200P
3" X 2-1/2"	2.00	.065	B31W-G300250P	B31W-R300250P
4" X 1-1/2"	10.00	.083	B31W-G400150P	B31W-R400150P
4" X 2"	8.00	.083	B31W-G400200P	B31W-R400200P
4" X 2-1/2"	6.00	.083	B31W-G400250P	B31W-R400250P
4" X 3"	4.00	.083	B31W-G400300P	B31W-R400300P
6" X 2"	5.50	.109	B31W-G600200P	B31W-R600200P
6" X 3"	5.50	.109	B31W-G600300P	B31W-R600300P
6" X 4"	5.50	.109	B31W-G600400P	B31W-R600400P
8" X 4"	6.00	.109	B31W-G800400P	B31W-R800400P
8" X 6"	7.00	.120	B31W-G800600P	B31W-R800600P
10" X 8"	7.00	.120	B31W-G1000800P	B31W-R1000800P

M

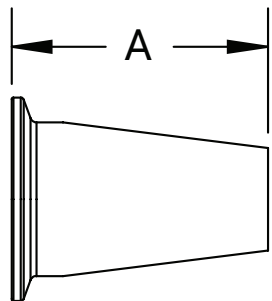

**Concentric Clamp x Weld Reducers - B31M**

Tube O.D.	A	Nominal Wall	304 Stainless Steel Part #	316L Stainless Steel Part #
3/4" x 1/2"	1.50	.065	---	B31M-R7550
1" x 1/2"	2.50	.065	---	B31M-R10050
1" x 3/4"	1.50	.065	---	B31M-R10075
1-1/2" x 1/2"	4.50	.065	---	B31M-R15050
1-1/2" x 3/4"	3.50	.065	---	B31M-R15075
1-1/2" x 1"	2.50	.065	B31M-G150100	B31M-R150100
2" x 1"	4.50	.065	B31M-G200100	B31M-R200100
2" x 1-1/2"	2.50	.065	B31M-G200150	B31M-R200150
2-1/2" x 1-1/2"	4.50	.065	B31M-G250150	B31M-R250150
2-1/2" x 2"	2.50	.065	B31M-G250200	B31M-R250200
3" x 1-1/2"	6.50	.065	B31M-G300150	B31M-R300150
3" x 2"	4.50	.065	B31M-G300200	B31M-R300200
3" x 2-1/2"	2.50	.065	B31M-G300250	B31M-R300250
4" x 2"	8.66	.083	B31M-G400200	B31M-R400200
4" x 2-1/2"	6.66	.083	B31M-G400250	B31M-R400250
4" x 3"	4.66	.083	B31M-G400300	B31M-R400300

## Weld Reducers

### Eccentric Weld Reducers - B32W

  
63-04

Tube O.D.	A (in)	Nominal Wall (in)	304 Stainless Steel Part #	316L Stainless Steel Part #
3/4" x 1/2"	1.00	.065	---	B32W-R7550P
1" x 1/2"	2.00	.065	---	B32W-R10050P
1" x 3/4"	1.00	.065	---	B32W-R10075P
1-1/2" x 1/2"	4.00	.065	---	B32W-R15050P
1-1/2" x 3/4"	3.00	.065	---	B32W-R15075P
1-1/2" x 1"	2.00	.065	B32W-G150100P	B32W-R150100P
2" x 1/2"	6.00	.065	---	B32W-R20050P
2" x 3/4"	5.00	.065	---	B32W-R20075P
2" x 1"	4.00	.065	B32W-G200100P	B32W-R200100P
2" x 1-1/2"	2.00	.065	B32W-G200150P	B32W-R200150P
2-1/2" x 1-1/2"	4.00	.065	B32W-G250150P	B32W-R250150P
2-1/2" x 2"	2.00	.065	B32W-G250200P	B32W-R250200P
3" x 1"	8.00	.065	B32W-G300100P	B32W-R300100P
3" x 1-1/2"	6.00	.065	B32W-G300150P	B32W-R300150P
3" x 2"	4.00	.065	B32W-G300200P	B32W-R300200P
3" x 2-1/2"	2.00	.065	B32W-G300250P	B32W-R300250P
4" x 1-1/2"	10.00	.083	B32W-G400150P	B32W-R400150P
4" x 2"	8.00	.083	B32W-G400200P	B32W-R400200P
4" x 2-1/2"	6.00	.083	B32W-G400250P	B32W-R400250P
4" x 3"	4.00	.083	B32W-G400300P	B32W-R400300P
6" x 3"	5.50	.109	B32W-G600300P	B32W-R600300P
6" x 4"	5.50	.109	B32W-G600400P	B32W-R600400P
8" x 4"	6.00	.109	B32W-G800400P	B32W-R800400P
8" x 6"	6.00	.109	B32W-G800600P	B32W-R800600P

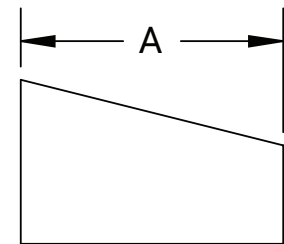
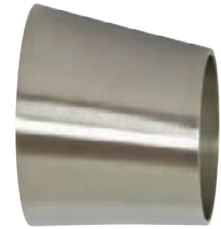

## Weld End Caps

### Weld End Caps - B16W

Tube O.D.	A (in)	304 Stainless Steel Part #	316L Stainless Steel Part #
1/2"	.25	---	B16W-R50
3/4"	.31	---	B16W-R75
1"	.38	B16W-G100	B16W-R100
1-1/2"	.56	B16W-G150	B16W-R150
2"	.75	B16W-G200	B16W-R200
2-1/2"	1.00	B16W-G250	B16W-R250
3"	1.25	B16W-G300	B16W-R300
4"	1.50	B16W-G400	B16W-R400
6"	2.00	B16W-G600	B16W-R600
8"	2.50	B16W-G800	B16W-R800

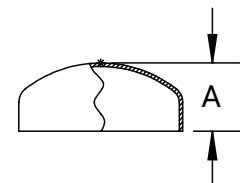

## Weld Adapters

### Long Weld Hose Adapters - 14WHRL

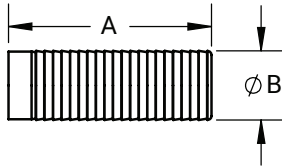

**Feature**

- Suitable for use with band clamps

Tube O.D.	A (in)	B (in)	Nominal Wall (in)	316L Stainless Steel Part #
1"	3.00	1.03	.116	14WHRL-R100
1-1/2"	4.50	1.53	.116	14WHRL-R150
2"	4.50	2.03	.116	14WHRL-R200
2-1/2"	5.00	2.53	.116	14WHRL-R250
3"	5.00	3.03	.116	14WHRL-R300
4"	4.88	4.03	.116	14WHRL-R400

NOTE: Use of PVC tubing requires special techniques to prevent leakage. All assembly work must be done with heated tube. Cold durometer is 90 as opposed to rubber hose at 65 to 70 durometer. Banding buckles must be at 180° from one another.

### Weld Hose Adapters - 14WHR

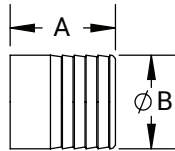

Tube O.D.	A (in)	B (in)	Nominal Wall (in)	316L Stainless Steel Part #
1/2"	1.50	.50	.065	14WHR-R50
3/4"	1.50	.75	.065	14WHR-R75
1"	1.69	1.00	.065	14WHR-R100
1-1/2"	1.69	1.50	.065	14WHR-R150
2"	2.31	2.00	.065	14WHR-R200
2-1/2"	2.00	2.50	.065	14WHR-R250
3"	3.09	3.00	.065	14WHR-R300
4"	3.41	4.00	.083	14WHR-R400

### Male NPT x Weld End Adapters - B19WB

**Feature**

- 32Ra finish I.D. only

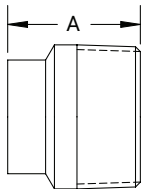

Tube O.D.	A (in)	Nominal Wall (in)	304 Stainless Steel Part #	316L Stainless Steel Part #
1/2"	1.63	.065	---	B19WB-R50
3/4"	1.63	.065	---	B19WB-R75
1"	1.75	.065	B19WB-G100	B19WB-R100
1-1/2"	1.75	.065	B19WB-G150	B19WB-R150
2"	1.81	.065	B19WB-G200	B19WB-R200
2-1/2"	2.31	.065	B19WB-G250	B19WB-R250
3"	2.50	.065	B19WB-G300	B19WB-R300
4"	2.56	.083	B19WB-G400	B19WB-R400
6"	3.40	.109	---	B19WB-R600

### Female NPT x Weld End Adapters - B22WB

**Feature**

- 32Ra finish I.D. only

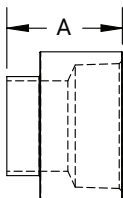

Tube O.D.	A (in)	Nominal Wall (in)	304 Stainless Steel Part #	316L Stainless Steel Part #
1/2"	1.25	.065	---	B22WB-R50
3/4"	1.63	.065	---	B22WB-R75
1"	1.75	.065	B22WB-G100	B22WB-R100
1-1/2"	1.75	.065	B22WB-G150	B22WB-R150
2"	1.81	.065	B22WB-G200	B22WB-R200
2-1/2"	2.31	.065	B22WB-G250	B22WB-R250
3"	2.50	.065	B22WB-G300	B22WB-R300
4"	2.50	.083	B22WB-G400	B22WB-R400

M



## Laterals, Wyes, Crosses, Bends, and Flanges

### Weld Laterals - B28WA

Tube O.D.	A (in)	B (in)	C (in)	Nominal Wall (in)	316L Stainless Steel Part #
1"	6.00	1.00	5.00	.065	B28WA-R100P
1-1/2"	7.38	1.19	6.19	.065	B28WA-R150P
2"	8.75	1.63	7.13	.065	B28WA-R200P
2-1/2"	10.00	1.50	8.50	.065	B28WA-R250P
3"	10.75	1.88	8.88	.065	B28WA-R300P
4"	12.81	2.02	10.75	.083	B28WA-R400P
6"	18.00	3.50	14.50	.109	B28WA-R600P
8"	22.00	5.00	17.00	.109	B28WA-R800P

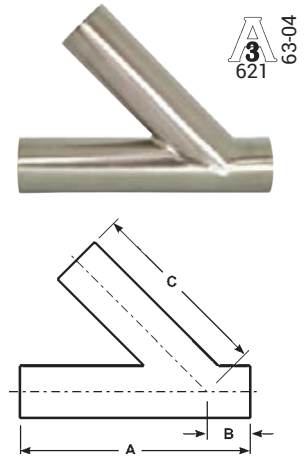

### Weld True Wyes - B28W

Tube O.D.	A (in)	B (in)	Nominal Wall (in)	316L Stainless Steel Part #
1"	2.21	2.65	.065	B28W-R100P
1-1/2"	2.31	2.75	.065	B28W-R150P
2"	3.04	3.66	.065	B28W-R200P
2-1/2"	3.89	4.64	.065	B28W-R250P
3"	4.62	5.50	.065	B28W-R300P
4"	6.20	6.40	.083	B28W-R400P
6"	3.50	8.00	.109	B28W-R600P

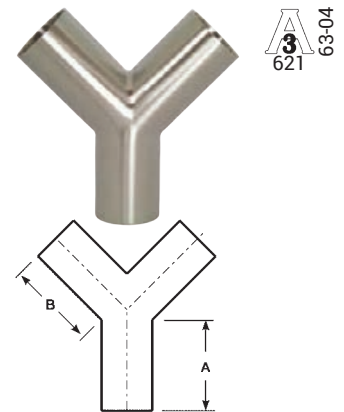

### Weld Crosses - B9WWWW

Tube O.D.	A (in)	B (in)	Nominal Wall (in)	304 Stainless Steel Part #	316L Stainless Steel Part #
1"	2.25	1.13	.065	B9WWWW-G100P	B9WWWW-R100P
1-1/2"	3.31	1.66	.065	B9WWWW-G150P	B9WWWW-R150P
2"	4.13	2.06	.065	B9WWWW-G200P	B9WWWW-R200P
2-1/2"	4.69	2.34	.065	B9WWWW-G250P	B9WWWW-R250P
3"	5.19	2.59	.065	B9WWWW-G300P	B9WWWW-R300P
4"	6.88	3.44	.083	B9WWWW-G400P	B9WWWW-R400P

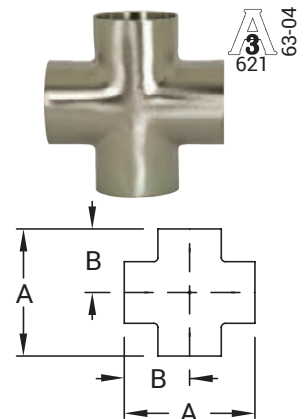

### Weld 180° Return Bends - B2WUL

**Size**

- Bends are standard 1.5 x tube diameter

Tube O.D.	A (in)	B (in)	316L Stainless Steel Part #
1"	3.00	2.00	B2WUL-R100P
1-1/2"	4.50	3.00	B2WUL-R150P
2"	6.00	4.00	B2WUL-R200P
2-1/2"	7.50	5.00	B2WUL-R250P
3"	9.00	6.00	B2WUL-R300P
4"	12.00	8.00	B2WUL-R400P

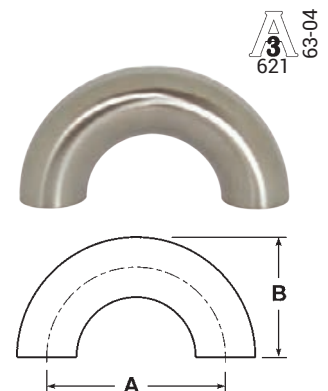

**Laterals, Wyes, Crosses, Bends, and Flanges**

**Weld End Blue Protection Covers - BCW**

**Application**

- Use these covers to protect all weld ends on fittings, valves, and pumps



Size	Vinyl Plastic Part #
1/2"	BCW-050
3/4"	BCW-075
1"	BCW-100
1-1/2"	BCW-150
2"	BCW-200
2-1/2"	BCW-250
3"	BCW-300
4"	BCW-400
6"	BCW-600
8"	BCW-800

**Weld Flanges**

**Slip-On 150# Flanges - B38SL**

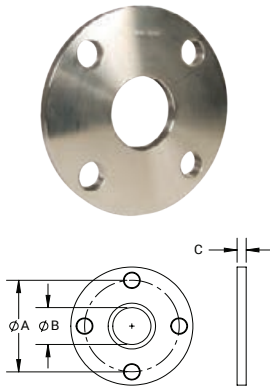

Tube O.D.	A (in)	B (in)	C (in)	Number & Diameter Bolt Holes (in)	Bolt Circle (in)	304 Stainless Steel Part #	316L Stainless Steel Part #
1"	3.13	1.06	0.38	4/.63	3.13	B38SL-G100	B38SL-R100
1-1/2"	3.88	1.56	0.38	4/.63	3.88	B38SL-G150	B38SL-R150
2"	4.75	2.06	0.44	4/.75	4.75	B38SL-G200	B38SL-R200
2-1/2"	5.50	2.56	0.44	4/.75	5.50	B38SL-G250	B38SL-R250
3"	6.00	3.06	0.50	4/.75	6.00	B38SL-G300	B38SL-R300
4"	7.50	4.06	0.56	8/.75	7.50	B38SL-G400	B38SL-R400
6"	9.50	6.06	0.56	8/.88	9.50	B38SL-G600	B38SL-R600
8"	11.75	8.06	0.69	8/.88	11.75	B38SL-G800	B38SL-R800
10"	14.25	10.06	0.69	12/1.00	14.25	B38SL-G1000	B38SL-R1000

**Weld Neck Flanges - B38W**

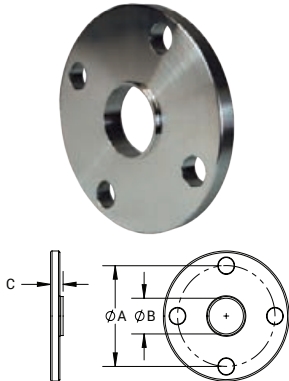

Tube O.D.	A (in)	B (in)	C (in)	Number & Diameter Bolt Holes (in)	Bolt Circle (in)	316L Stainless Steel Part #
1"	3.13	0.87	0.50	4/.63	3.13	B38W-R100
1-1/2"	3.88	1.37	0.50	4/.63	3.88	B38W-R150
2"	4.75	1.87	0.63	4/.75	4.75	B38W-R200
2-1/2"	5.50	2.37	0.63	4/.75	5.50	B38W-R250
3"	6.00	2.87	0.63	4/.75	6.00	B38W-R300
4"	7.50	3.83	0.63	8/.75	7.50	B38W-R400
6"	9.50	5.78	0.63	8/.88	9.50	B38W-R600
8"	11.75	7.78	0.63	8/.88	11.75	B38W-R800
10"	14.25	9.76	0.81	12/1.00	14.25	B38W-R1000

NOTE: For flange dimensions, diagrams, and additional information, please reference [dixonvalve.com](http://dixonvalve.com).

**Flange Gaskets**

**Size**

- Standard drop-ring type all 1/16" thick



Size	Neoprene Part #
1"	NG10
1-1/4"	NG15
1-1/2"	NG20
2"	NG25
2-1/2"	NG30
3"	NG35
4"	NG40
5"	NG50
6"	NG60
8"	NG80

M

## Unpolished Elbows

### Unpolished 90° Weld Elbows with Tangents - B2S

Tube O.D.	A (in)	R (in)	Nominal Wall	304 Stainless Steel Part #	316L Stainless Steel Part #
1/2"	3.000	1.125	.065	---	B2S-R50U
3/4"	3.000	1.125	.065	---	B2S-R75U
1"	2.062	1.500	.065	B2S-G100U	B2S-R100U
1-1/2"	2.937	2.250	.065	B2S-G150U	B2S-R150U
2"	4.062	3.000	.065	B2S-G200U	B2S-R200U
2-1/2"	5.187	3.750	.065	B2S-G250U	B2S-R250U
3"	6.312	4.500	.065	B2S-G300U	B2S-R300U
4"	8.312	6.000	.083	B2S-G400U	B2S-R400U

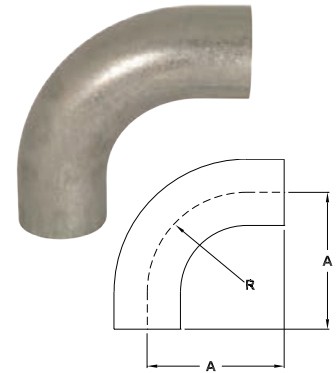

### Unpolished 90° Weld Elbows - B2WCL

Tube O.D.	A (in)	R (in)	Nominal Wall (in)	304 Stainless Steel Part #	316L Stainless Steel Part #
1/2"	1.13	1.13	.065	---	B2WCL-R50U
3/4"	1.13	1.13	.065	---	B2WCL-R75U
1"	1.50	1.50	.065	B2WCL-G100U	B2WCL-R100U
1-1/2"	2.25	2.25	.065	B2WCL-G150U	B2WCL-R150U
2"	3.00	3.00	.065	B2WCL-G200U	B2WCL-R200U
2-1/2"	3.75	3.75	.065	B2WCL-G250U	B2WCL-R250U
3"	4.50	4.50	.065	B2WCL-G300U	B2WCL-R300U
4"	6.00	6.00	.083	B2WCL-G400U	B2WCL-R400U
6"	9.00	9.00	.109	B2WCL-G600U	B2WCL-R600U
8"	12.00	12.00	.109	B2WCL-G800U	B2WCL-R800U
10"	15.00	15.00	.120	B2WCL-G1000U	B2WCL-R1000U
12"	18.00	18.00	.120	B2WCL-G1200U	B2WCL-R1200U

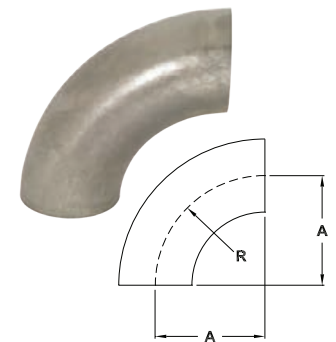

### Unpolished 45° Weld Elbows with Tangents - B2KS

Tube O.D.	A (in)	R (in)	Nominal Wall (in)	304 Stainless Steel Part #	316L Stainless Steel Part #
1/2"	2.25	1.13	.065	---	B2KS-R50U
3/4"	2.25	1.13	.065	---	B2KS-R75U
1"	1.19	1.50	.065	B2KS-G100U	B2KS-R100U
1-1/2"	1.63	2.25	.065	B2KS-G150U	B2KS-R150U
2"	2.31	3.00	.065	B2KS-G200U	B2KS-R200U
2-1/2"	3.00	3.75	.065	B2KS-G250U	B2KS-R250U
3"	3.69	4.50	.065	B2KS-G300U	B2KS-R300U
4"	4.81	6.00	.083	B2KS-G400U	B2KS-R400U

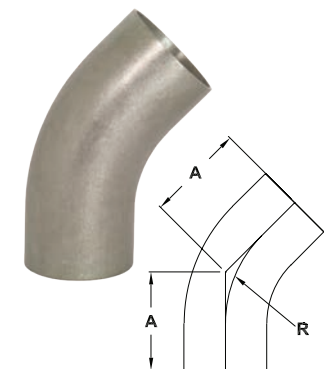

### Unpolished 45° Weld Elbows - B2WK

Tube O.D.	A (in)	R (in)	Nominal Wall (in)	304 Stainless Steel Part #	316L Stainless Steel Part #
1/2"	.47	1.13	.065	---	B2WK-R50U
3/4"	.47	1.13	.065	---	B2WK-R75U
1"	.63	1.50	.065	B2WK-G100U	B2WK-R100U
1-1/2"	.94	2.25	.065	B2WK-G150U	B2WK-R150U
2"	1.25	3.00	.065	B2WK-G200U	B2WK-R200U
2-1/2"	1.56	3.75	.065	B2WK-G250U	B2WK-R250U
3"	1.88	4.50	.065	B2WK-G300U	B2WK-R300U
4"	2.50	6.00	.083	B2WK-G400U	B2WK-R400U
6"	3.75	9.00	.109	B2WK-G600U	B2WK-R600U
8"	5.00	12.00	.109	B2WK-G800U	B2WK-R800U
10"	6.25	15.00	.120	B2WK-G1000U	B2WK-R1000U
12"	7.50	18.00	.120	B2WK-G1200U	B2WK-R1200U



Unpolished Tees

Unpolished Short Weld Tees - B7WWW

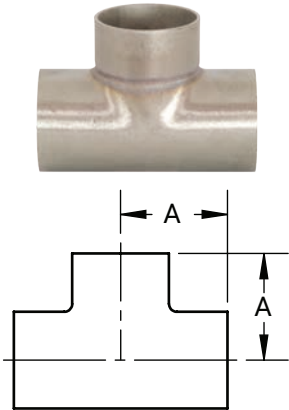

Tube O.D.	A (in)	Nominal Wall (in)	304 Stainless Steel Part #	316L Stainless Steel Part #
1"	1.13	.065	B7WWW-G100U	B7WWW-R100U
1-1/2"	1.66	.065	B7WWW-G150U	B7WWW-R150U
2"	2.06	.065	B7WWW-G200U	B7WWW-R200U
2-1/2"	2.34	.065	B7WWW-G250U	B7WWW-R250U
3"	2.59	.065	B7WWW-G300U	B7WWW-R300U
4"	3.44	.083	B7WWW-G400U	B7WWW-R400U

Unpolished Long Weld Tees - B7W

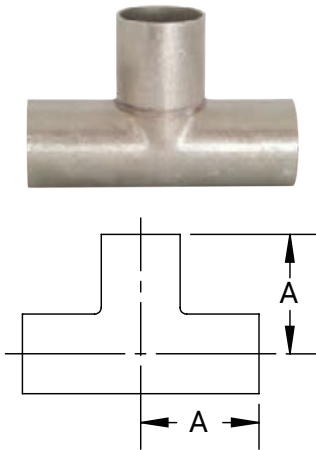

Tube O.D.	A (in)	Nominal Wall (in)	304 Stainless Steel Part #	316L Stainless Steel Part #
1/2"	1.88	.065	---	B7W-R50U
3/4"	2.00	.065	---	B7W-R75U
1"	1.88	.065	B7W-G100U	B7W-R100U
1-1/2"	2.25	.065	B7W-G150U	B7W-R150U
2"	3.00	.065	B7W-G200U	B7W-R200U
2-1/2"	3.00	.065	B7W-G250U	B7W-R250U
3"	3.25	.065	B7W-G300U	B7W-R300U
4"	3.88	.083	B7W-G400U	B7W-R400U
6"	5.63	.109	B7W-G600U	B7W-R600U
8"	7.00	.109	B7W-G800U	B7W-R800U

Unpolished Reducing Weld Tees - B7RWWW

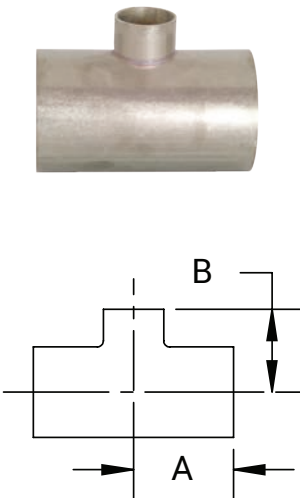

Tube O.D.	A (in)	B (in)	Nominal Wall (in)	304 Stainless Steel Part #	316L Stainless Steel Part #
1-1/2" x 3/4"	2.13	2.13	.065	---	B7RWWW-R15075U
1-1/2" x 1"	2.38	2.38	.065	B7RWWW-G150100U	B7RWWW-R150100U
2" x 1/2"	2.38	2.38	.065	---	B7RWWW-R20050U
2" x 3/4"	1.66	1.38	.065	---	B7RWWW-R20075U
2" x 1"	2.06	1.63	.065	B7RWWW-G200100U	B7RWWW-R200100U
2" x 1-1/2"	2.06	1.91	.065	B7RWWW-G200150U	B7RWWW-R200150U
2-1/2" x 1-1/2"	2.34	2.16	.065	B7RWWW-G250150U	B7RWWW-R250150U
2-1/2" x 2"	2.34	2.31	.065	B7RWWW-G250200U	B7RWWW-R250200U
3" x 1-1/2"	2.59	2.41	.065	B7RWWW-G300150U	B7RWWW-R300150U
3" x 2"	2.59	2.56	.065	B7RWWW-G300200U	B7RWWW-R300200U
3" x 2-1/2"	2.59	2.59	.065	B7RWWW-G300250U	B7RWWW-R300250U
4" x 1-1/2"	3.44	2.91	.083	B7RWWW-G400150U	B7RWWW-R400150U
4" x 2"	3.44	3.06	.083	B7RWWW-G400200U	B7RWWW-R400200U
4" x 2-1/2"	3.44	3.09	.083	B7RWWW-G400250U	B7RWWW-R400250U
4" x 3"	3.44	3.09	.083	B7RWWW-G400300U	B7RWWW-R400300U

M

## Unpolished Reducers

## Unpolished Concentric Weld Reducers - B31W

Tube O.D.	A (in)	Nominal Wall (in)	304 Stainless Steel Part #	316L Stainless Steel Part #
3/4" x 1/2"	1.00	.065	---	B31W-R7550U
1" x 1/2"	2.00	.065	---	B31W-R10050U
1" x 3/4"	1.00	.065	---	B31W-R10075U
1-1/2" x 1/2"	4.00	.065	---	B31W-R15050U
1-1/2" x 3/4"	3.00	.065	---	B31W-R15075U
1-1/2" x 1"	2.00	.065	B31W-G150100U	B31W-R150100U
2" x 3/4"	5.00	.065	---	B31W-R20075U
2" x 1"	4.00	.065	B31W-G200100U	B31W-R200100U
2" x 1-1/2"	2.00	.065	B31W-G200150U	B31W-R200150U
2-1/2" x 1-1/2"	4.00	.065	B31W-G250150U	B31W-R250150U
2-1/2" x 2"	2.00	.065	B31W-G250200U	B31W-R250200U
3" x 1"	8.00	.109	B31W-G300100U	B31W-R300100U
3" x 1-1/2"	6.00	.065	B31W-G300150U	B31W-R300150U
3" x 2"	4.00	.065	B31W-G300200U	B31W-R300200U
3" x 2-1/2"	2.00	.065	B31W-G300250U	B31W-R300250U
4" x 1-1/2"	10.00	.083	B31W-G400150U	B31W-R400150U
4" x 2"	8.00	.109	B31W-G400200U	B31W-R400200U
4" x 2-1/2"	6.00	.083	B31W-G400250U	B31W-R400250U
4" x 3"	4.00	.083	B31W-G400300U	B31W-R400300U
6" x 3"	5.50	.109	B31W-G600300U	B31W-R600300U
6" x 4"	5.50	.109	B31W-G600400U	B31W-R600400U
8" x 4"	6.00	.109	B31W-G800400U	B31W-R800400U
8" x 6"	6.00	.109	B31W-G800600U	B31W-R800600U

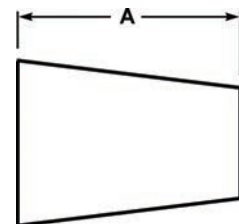

## Unpolished Eccentric Weld Reducers - B32W

Tube O.D.	A (in)	Nominal Wall (in)	304 Stainless Steel Part #	316L Stainless Steel Part #
3/4" x 1/2"	1.00	.065	---	B32W-R7550U
1" x 1/2"	2.00	.065	---	B32W-R10050U
1" x 3/4"	1.00	.065	---	B32W-R10075U
1-1/2" x 1/2"	4.00	.065	---	B32W-R15050U
1-1/2" x 3/4"	3.00	.065	---	B32W-R15075U
1-1/2" x 1"	2.00	.065	B32W-G150100U	B32W-R150100U
2" x 3/4"	5.00	.065	---	B32W-R20075U
2" x 1"	4.00	.065	B32W-G200100U	B32W-R200100U
2" x 1-1/2"	2.00	.065	B32W-G200150U	B32W-R200150U
2-1/2" x 2"	2.00	.065	B32W-G250200U	B32W-R250200U
3" x 1-1/2"	6.00	.065	B32W-G300150U	B32W-R300150U
3" x 2"	4.00	.065	B32W-G300200U	B32W-R300200U
3" x 2-1/2"	2.00	.065	B32W-G300250U	B32W-R300250U
4" x 1-1/2"	10.00	.083	B32W-G400150U	B32W-R400150U
4" x 2"	8.00	.109	B32W-G400200U	B32W-R400200U
4" x 3"	4.00	.083	B32W-G400300U	B32W-R400300U
6" x 4"	5.50	.109	B32W-G600400U	B32W-R600400U
8" x 6"	6.00	.109	B32W-G800600U	B32W-R800600U

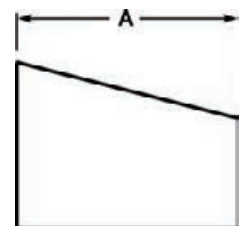

M

Laterals, Wyes, Bends, and Flanges

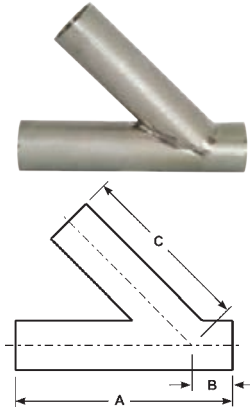

Unpolished Weld Laterals - B28WA

Tube O.D.	A (in)	B (in)	C (in)	Nominal Wall (in)	316L Stainless Steel Part #
1"	6.00	1.00	5.00	.065	B28WA-R100U
1-1/2"	7.38	1.19	6.19	.065	B28WA-R150U
2"	8.75	1.63	7.13	.065	B28WA-R200U
2-1/2"	10.00	1.50	8.50	.065	B28WA-R250U
3"	10.75	1.88	8.88	.065	B28WA-R300U
4"	12.81	2.02	10.75	.083	B28WA-R400U
6"	18.00	3.00	14.50	.109	B28WA-R600U

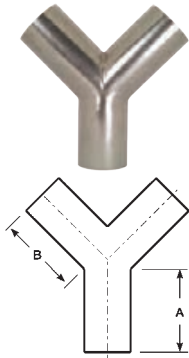

Unpolished Weld True Wyes - B28W

Tube O.D.	A (in)	B (in)	Nominal Wall (in)	316L Stainless Steel Part #
1"	2.00	2.44	.065	B28W-R100U
1-1/2"	2.00	2.44	.065	B28W-R150U
2"	2.63	3.25	.065	B28W-R200U
2-1/2"	3.37	4.13	.065	B28W-R250U
3"	4.00	4.88	.065	B28W-R300U
4"	5.38	5.38	.083	B28W-R400U
6"	8.00	8.00	.109	B28W-R600U



Unpolished Weld 180° Return Bends - B2WUL

Feature

- Bends are standard 1.5 x tube diameter

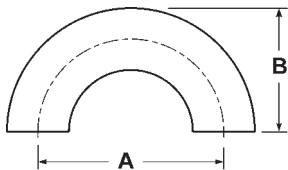

Tube O.D.	A (in)	B (in)	Nominal Wall (in)	316L Stainless Steel Part #
1"	3.00	2.00	.065	B2WUL-R100U
1-1/2"	4.50	3.00	.065	B2WUL-R150U
2"	6.00	4.00	.065	B2WUL-R200U
2-1/2"	7.50	5.00	.065	B2WUL-R250U
3"	9.00	6.00	.065	B2WUL-R300U
4"	12.00	8.00	.083	B2WUL-R400U

Weld End Blue Protection Covers - BCW

Application

- Use these covers to protect all weld ends on fittings, valves, and pumps



Size	Vinyl Plastic Part #
1/2"	BCW-050
3/4"	BCW-075
1"	BCW-100
1-1/2"	BCW-150
2"	BCW-200
2-1/2"	BCW-250
3"	BCW-300
4"	BCW-400
6"	BCW-600
8"	BCW-800

M

## Laterals, Wyes, Bends, and Flanges

### Unpolished Type A Stub Ends - 14VB

**Application**

- Typically used with B38SL flanges

Tube O.D.	A (in)	316L Stainless Steel Part #
1/2"	1.38	14VB-R50
3/4"	1.38	14VB-R75
1"	1.63	14VB-R100
1-1/2"	1.75	14VB-R150
2"	1.50	14VB-R200
2-1/2"	2.00	14VB-R250
3"	2.25	14VB-R300
4"	2.63	14VB-R400
6"	3.00	14VB-R600
8"	3.00	14VB-R800
10"	3.50	14VB-R1000

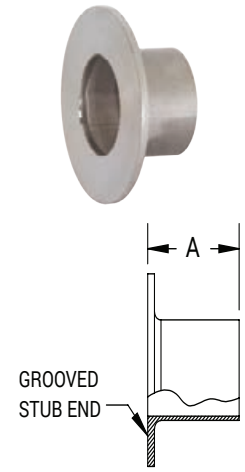

## Flange Gaskets

**Size**

- Standard drop-ring type all 1/16" thick

Size	Neoprene Part #
1"	NG10
1-1/4"	NG15
1-1/2"	NG20
2"	NG25
2-1/2"	NG30
3"	NG35
4"	NG40
5"	NG50
6"	NG60
8"	NG80



M

**Bevel Seat Nuts**

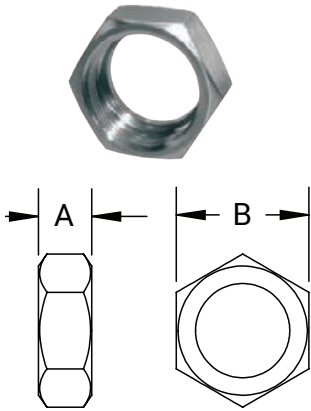

**Union Hex Nuts - 13H**

Tube O.D.	A (in)	B (in)	304 Stainless Steel (CF8) Part #
1"	.91	1.81	13H-G100
1-1/2"	.97	2.41	13H-G150
2"	1.06	3.00	13H-G200
2-1/2"	1.19	3.59	13H-G250
3"	1.28	4.19	13H-G300
4"	1.50	5.44	13H-G400

**Bevel Seat Wrenches**

**Single Side Hex Wrenches - 25H**

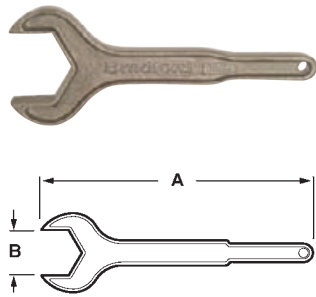

Tube O.D.	A (in)	B (in)	Weight lbs.	Aluminum Part #
1"	10.50	1.81	.64	25H-100
1-1/2"	12.00	2.41	.86	25H-150
2"	14.00	3.00	1.76	25H-200
2-1/2"	16.25	3.59	2.40	25H-250
3"	18.50	4.19	3.04	25H-300
4"	19.50	5.44	3.62	25H-400

**Two Sided Hex Wrenches - 25H**

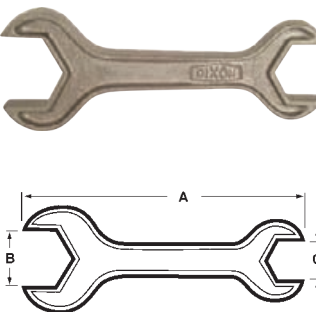

Tube O.D.	A (in)	B (in)	C (in)	Weight lbs.	Aluminum Part #
1-1/2" x 1"	12.00	2.41	1.81	1.00	25H-150100
2" x 1-1/2"	14.00	3.00	2.41	1.75	25H-200150
2-1/2" x 2"	16.50	3.59	3.00	2.80	25H-250200
3" x 2"	18.00	4.19	3.00	3.20	25H-300200
3" x 2-1/2"	18.00	4.19	3.59	3.70	25H-300250

M



## Bevel Seat Ferrules

### Short Plain Bevel Seat Weld Ferrules - 14PRF

Tube O.D.	A (in)	B (in)	304 Stainless Steel Part #	316L Stainless Steel Part #
1"	.72	.87	14PRF-G100	14PRF-R100
1-1/2"	.72	1.37	14PRF-G150	14PRF-R150
2"	.75	1.87	14PRF-G200	14PRF-R200
2-1/2"	.88	2.37	14PRF-G250	14PRF-R250
3"	.91	2.87	14PRF-G300	14PRF-R300
4"	1.03	3.83	14PRF-G400	14PRF-R400

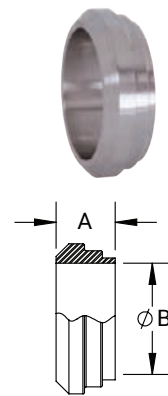

 63-04

### Long Plain Bevel Seat Weld Ferrules - 14A

Tube O.D.	A (in)	B (in)	304 Stainless Steel Part #	316L Stainless Steel Part #
1"	1.38	.87	14A-G100	14A-R100
1-1/2"	1.50	1.37	14A-G150	14A-R150
2"	1.50	1.87	14A-G200	14A-R200
2-1/2"	1.75	2.37	14A-G250	14A-R250
3"	1.75	2.87	14A-G300	14A-R300
4"	1.75	3.83	14A-G400	14A-R400

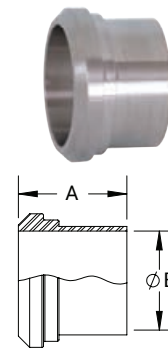

 63-04

### Recessed Plain Bevel Seat Weld Ferrules - 14

Tube O.D.	A (in)	B (in)	304 Stainless Steel Part #
1"	.75	1.01	14-G100
1-1/2"	.88	1.51	14-G150
2"	.97	2.01	14-G200
2-1/2"	1.06	2.51	14-G250
3"	1.13	3.01	14-G300
4"	1.25	4.01	14-G400

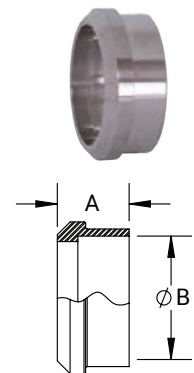
**M**

### Recessless Plain Bevel Seat Ferrules for Expanding - 14R

Tube O.D.	A (in)	B (in)	304 Stainless Steel Part #
1"	.750	1.000	14R-G100
1-1/2"	1.125	1.500	14R-G150
2"	1.312	2.000	14R-G200
2-1/2"	1.375	2.500	14R-G250
3"	1.437	3.000	14R-G300
4"	1.500	4.000	14R-G400

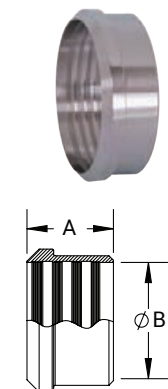

**Bevel Seat Ferrules**

**A**  
3  
621  
63-04

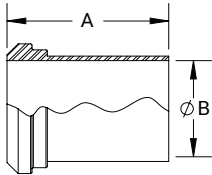

**Light Wall Tank Plain Bevel Seat Ferrules - 14WL**

Tube O.D.	A (in)	B (in)	304 Stainless Steel Part #
1"	2.00	.87	14WL-G100
1-1/2"	2.25	1.37	14WL-G150
2"	2.50	1.87	14WL-G200
2-1/2"	2.75	2.37	14WL-G250
3"	3.00	2.87	14WL-G300
4"	4.00	3.83	14WL-G400

**A**  
3  
621  
63-04

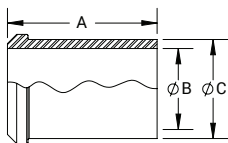

**Heavy Wall Tank Plain Bevel Seat Ferrules - 14W**

Tube O.D.	A (in)	B (in)	C (in)	304 Stainless Steel Part #
1"	2.38	.87	1.16	14W-G100
1-1/2"	2.53	1.37	1.68	14W-G150
2"	2.78	1.87	2.19	14W-G200
2-1/2"	3.06	2.37	2.71	14W-G250
3"	3.53	2.87	3.22	14W-G300
4"	4.31	3.83	4.26	14W-G400

**M**

**A**  
3  
621  
63-04

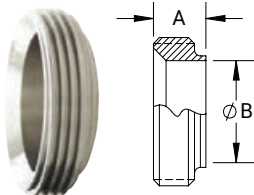

**Short Threaded Bevel Seat Weld Ferrules - 15TRF**

Tube O.D.	A (in)	B (in)	304 Stainless Steel Part #	316L Stainless Steel Part #
1"	.72	.87	15TRF-G100	15TRF-R100
1-1/2"	.72	1.37	15TRF-G150	15TRF-R150
2"	.75	1.87	15TRF-G200	15TRF-R200
2-1/2"	.88	2.37	15TRF-G250	15TRF-R250
3"	.91	2.87	15TRF-G300	15TRF-R300
4"	1.03	3.83	15TRF-G400	15TRF-R400

**A**  
3  
621  
63-04

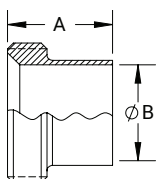

**Long Threaded Bevel Seat Weld Ferrules - 15A**

Tube O.D.	A (in)	B (in)	304 Stainless Steel Part #	316L Stainless Steel Part #
1"	1.38	.87	15A-G100	15A-R100
1-1/2"	1.50	1.37	15A-G150	15A-R150
2"	1.50	1.87	15A-G200	15A-R200
2-1/2"	1.75	2.37	15A-G250	15A-R250
3"	1.75	2.87	15A-G300	15A-R300
4"	1.75	3.83	15A-G400	15A-R400

## Bevel Seat Ferrules

### Recessed Threaded Bevel Seat Ferrules - 15

Tube O.D.	A (in)	B (in)	304 Stainless Steel Part #
1"	0.81	1.01	15-G100
1-1/2"	0.88	1.51	15-G150
2"	1.03	2.01	15-G200
2-1/2"	1.13	2.51	15-G250
3"	1.25	3.01	15-G300
4"	1.38	4.01	15-G400

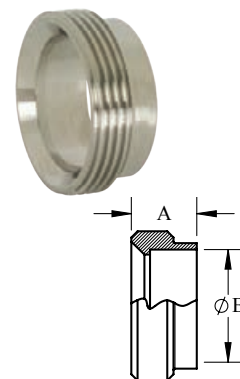

### Recessless Threaded Bevel Seat Ferrules for Expanding - 15R

Tube O.D.	A (in)	B (in)	304 Stainless Steel Part #
1"	.81	1.01	15R-G100
1-1/2"	1.13	1.51	15R-G150
2"	1.38	2.01	15R-G200
2-1/2"	1.50	2.51	15R-G250
3"	1.63	3.01	15R-G300
4"	1.68	4.01	15R-G400

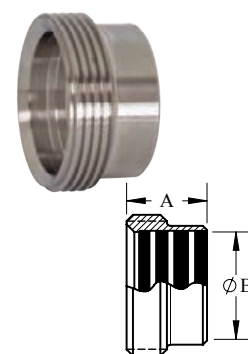

### Light Wall Tank Threaded Bevel Seat Ferrules - 15WL

Tube O.D.	A (in)	B (in)	304 Stainless Steel Part #
1"	2.00	.87	15WL-G100
1-1/2"	2.25	1.37	15WL-G150
2"	2.50	1.87	15WL-G200
2-1/2"	2.75	2.37	15WL-G250
3"	3.00	2.87	15WL-G300
4"	4.00	3.83	15WL-G400

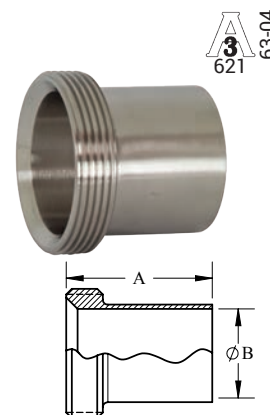

### Heavy Wall Tank Threaded Bevel Seat Ferrules - 15W

Tube O.D.	A (in)	B (in)	C (in)	304 Stainless Steel Part #	316L Stainless Steel Part #
1"	1.50	.87	1.16	15W-G100	15W-R100
1-1/2"	1.63	1.37	1.68	15W-G150	15W-R150
2"	1.75	1.87	2.19	15W-G200	15W-R200
2-1/2"	1.75	2.37	2.71	15W-G250	15W-R250
3"	1.81	2.87	3.22	15W-G300	15W-R300
4"	2.13	3.83	4.26	15W-G400	15W-R400

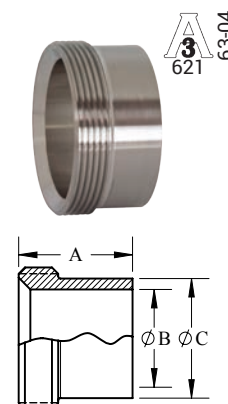

**Bevel Seat Elbows**

3 63-04  
621

**Threaded Bevel Seat x Threaded Bevel Seat 90° Elbows - B2C**

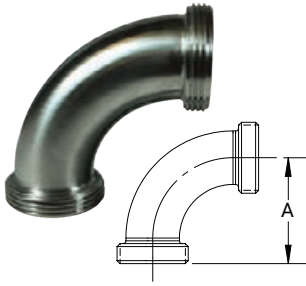

Tube O.D.	A (in)	304 Stainless Steel Part #
1"	2.22	B2C-G100
1-1/2"	2.97	B2C-G150
2"	3.75	B2C-G200
2-1/2"	4.63	B2C-G250
3"	5.41	B2C-G300
4"	7.03	B2C-G400

3 63-04  
621

**Threaded Bevel Seat x Plain Bevel Seat with Hex Nut 90° Elbows - B2F**



Tube O.D.	A (in)	304 Stainless Steel Part #
1"	2.22	B2F-G100
1-1/2"	2.97	B2F-G150
2"	3.75	B2F-G200
2-1/2"	4.63	B2F-G250
3"	5.41	B2F-G300
4"	7.03	B2F-G400

3 63-04  
621

**Plain Bevel Seat x Plain Bevel Seat with Hex Nut 90° Elbows - B2E**

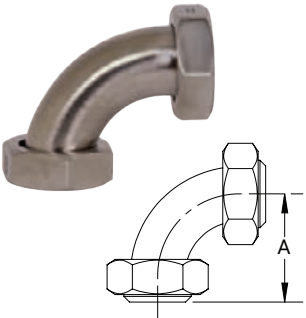

Tube O.D.	A (in)	304 Stainless Steel Part #
1"	2.22	B2E-G100
1-1/2"	2.97	B2E-G150
2"	3.75	B2E-G200
2-1/2"	4.63	B2E-G250
3"	5.41	B2E-G300
4"	7.03	B2E-G400

3 63-04  
621

**Threaded Bevel Seat x Plain Bevel Seat with Hex Nut 45° Elbows - B2P**

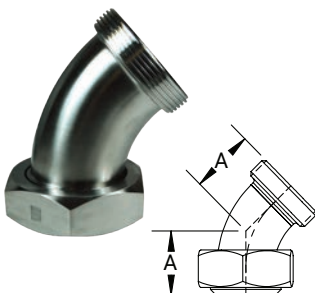

Tube O.D.	A (in)	304 Stainless Steel Part #
1"	1.34	B2P-G100
1-1/2"	1.66	B2P-G150
2"	2.00	B2P-G200
2-1/2"	2.44	B2P-G250
3"	2.78	B2P-G300
4"	3.53	B2P-G400

M

## Bevel Seat Concentric Reducers

### Plain Bevel Seat x Threaded Bevel Seat Concentric Reducers - B3115F

 63-04

Tube O.D.	A (in)	304 Stainless Steel Part #
1-1/2" x 1"	3.44	B3115F-G150100
2" x 1-1/2"	3.47	B3115F-G200150
2-1/2" x 2"	3.63	B3115F-G250200
3" x 2"	5.66	B3115F-G300200
3" x 2-1/2"	3.78	B3115F-G300250
4" x 3"	5.94	B3115F-G400300

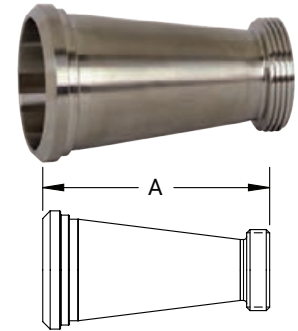

### Threaded Bevel Seat x Threaded Bevel Seat Concentric Reducers - B31TT

 63-04

Tube O.D.	A (in)	304 Stainless Steel Part #
1-1/2" x 1"	3.44	B31TT-G150100
2" x 1-1/2"	3.47	B31TT-G200150
2-1/2" x 2"	3.63	B31TT-G250200
3" x 2"	5.66	B31TT-G300200
3" x 2-1/2"	3.78	B31TT-G300250
4" x 3"	5.94	B31TT-G400300

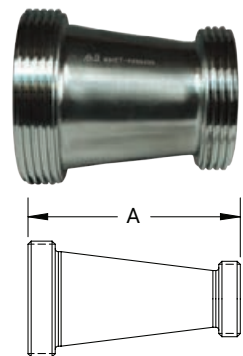

### Threaded Bevel Seat x Plain Bevel Seat with Hex Nut Concentric Reducers - B31TP

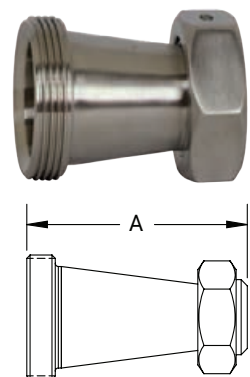

 63-04

Tube O.D.	A (in)	304 Stainless Steel Part #
1-1/2" x 1"	3.44	B31TP-G150100
2" x 1-1/2"	3.47	B31TP-G200150
2-1/2" x 2"	3.63	B31TP-G250200
3" x 2"	5.66	B31TP-G300200
3" x 2-1/2"	3.78	B31TP-G300250
4" x 3"	5.94	B31TP-G400300

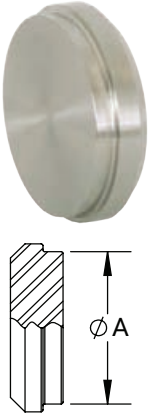

**Bevel Seat End Caps**

3  
621  
63-04



Plain Bevel Seat Solid End Caps - 16A

Tube O.D.	A (in)	304 Stainless Steel Part #	316L Stainless Steel Part #
1"	1.16	16A-G100	16A-R100
1-1/2"	1.67	16A-G150	16A-R150
2"	2.19	16A-G200	16A-R200
2-1/2"	2.71	16A-G250	16A-R250
3"	3.22	16A-G300	16A-R300
4"	4.26	16A-G400	16A-R400

**Bevel Seat Adapters**

Plain Bevel Seat Tygon® Hose Adapters - 14AHT

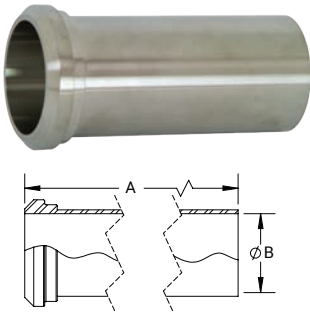

Tube O.D.	A (in)	B (in)	304 Stainless Steel Part #
1"	4.69	.87	14AHT-G100
1-1/2"	4.72	1.37	14AHT-G150
2"	4.72	1.87	14AHT-G200
2-1/2"	4.84	2.37	14AHT-G250
3"	4.91	2.87	14AHT-G300
4"	5.22	3.83	14AHT-G400

M

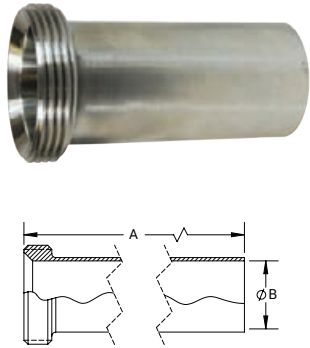

Threaded Bevel Seat Tygon® Hose Adapters - 15AHT

Tube O.D.	A (in)	B (in)	304 Stainless Steel Part #
1"	4.50	.87	15AHT-G100
1-1/2"	4.50	1.37	15AHT-G150
2"	4.50	1.87	15AHT-G200
2-1/2"	4.50	2.37	15AHT-G250
3"	4.50	2.87	15AHT-G300
4"	5.00	3.83	15AHT-G400

Plain Bevel Seat Rubber Hose Adapters - 14AHR

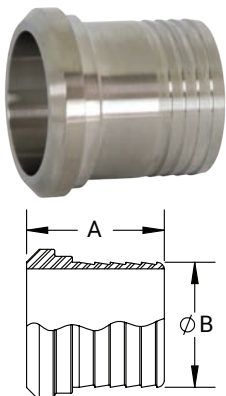

Tube O.D.	A (in)	B (in)	304 Stainless Steel Part #
1"	1.69	1.00	14AHR-G100
1-1/2"	1.69	1.50	14AHR-G150
2"	2.31	2.00	14AHR-G200
2-1/2"	2.67	2.50	14AHR-G250
3"	3.10	3.00	14AHR-G300
4"	4.00	4.00	14AHR-G400

## I-line / Q-line Clamps

## Heavy Duty Clamps - 13ILH

Tube O.D.	Service Pressure Rating PSI @ 70°F (21°C) <sup>1</sup>	Service Pressure Rating PSI @ 250°F (121°C) <sup>1</sup>	A (in)	Part #
1"- 1-1/2"	700	250	2.12	13ILH100-150
2"	450	250	2.65	13ILH200
2-1/2"	450	200	3.19	13ILH250
3"	350	150	3.72	13ILH300
4"	200	125	4.82	13ILH400
6"	150	100	7.69	13ILH600
8"	125	75	9.69	13ILH800



<sup>1</sup> Wing nut tightened to 25 in-lb of torque

## Bolted Clamps - 13ILB

Tube O.D.	Service Pressure Rating PSI @ 70°F (21°C) <sup>1</sup>	Service Pressure Rating PSI @ 250°F (121°C) <sup>1</sup>	A (in)	Part #
1"- 1-1/2"	1220	1100	2.12	13ILB100-150
2"	900	830	2.65	13ILB200
2-1/2"	720	660	3.19	13ILB250
3"	600	550	3.72	13ILB300
4"	570	525	4.82	13ILB400

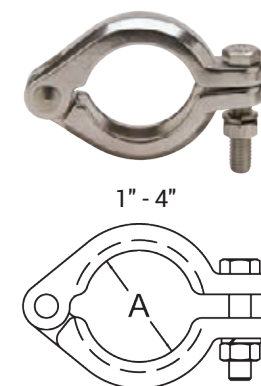

<sup>1</sup> Nut tightened to 20 ft-lb of torque

Tube O.D.	Service Pressure Rating PSI @ 70°F (21°C) <sup>1</sup>	Service Pressure Rating PSI @ 250°F (121°C) <sup>1</sup>	A (in)	Part #
6"	300	200	7.69	13ILB600
8"	250	150	9.69	13ILB800

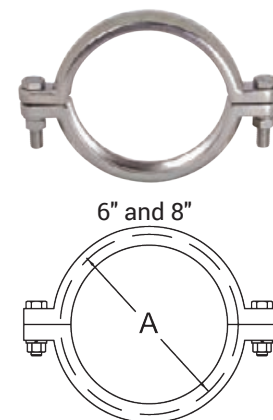

<sup>1</sup> Nut tightened to 20 ft-lb of torque

## Squeeze Clamps - 13IL-Q

Tube O.D.	Service Pressure Rating PSI @ 70°F (21°C) <sup>1</sup>	Service Pressure Rating PSI @ 250°F (121°C) <sup>1</sup>	A (in)	Part #
1"- 1-1/2"	700	250	2.12	13IL-Q100150
2"	450	250	2.65	13IL-Q200

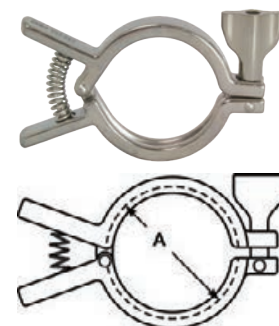

<sup>1</sup> Wing nut tightened to 25 in-lb of torque

I-Line/Q-Line - Ferrules

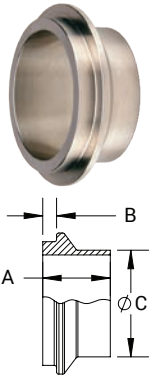

Male I-Line Short Weld Ferrules - 14WI

Tube O.D.	A (in)	B (in)	C (in)	304 Stainless Steel Part #	316L Stainless Steel Part #
1"	.79	.19	1.00	14WI-G100	14WI-R100
1-1/2"	.95	.20	1.50	14WI-G150	14WI-R150
2"	1.04	.26	2.00	14WI-G200	14WI-R200
2-1/2"	1.16	.31	2.50	14WI-G250	14WI-R250
3"	1.22	.31	3.00	14WI-G300	14WI-R300
4"	1.35	.31	4.00	14WI-G400	14WI-R400
6"	1.13	.19	6.00	---	14WI-R600
8"	1.13	.19	8.00	---	14WI-R800

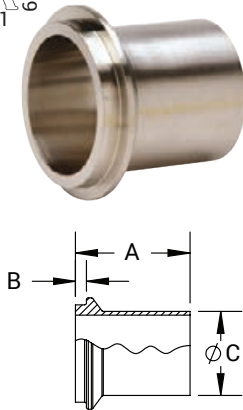

Male I-Line Long Weld Ferrules - 14WLI

Tube O.D.	A (in)	B (in)	C (in)	304 Stainless Steel Part #	316L Stainless Steel Part #
1"	1.755	0.19	1.00	14WLI-G100	14WLI-R100
1-1/2"	2.035	0.20	1.50	14WLI-G150	14WLI-R150
2"	2.320	0.26	2.00	14WLI-G200	14WLI-R200
2-1/2"	2.500	0.31	2.50	14WLI-G250	14WLI-R250
3"	2.685	0.31	3.00	14WLI-G300	14WLI-R300
4"	3.005	0.31	4.00	14WLI-G400	14WLI-R400
6"	2.884	0.19	6.00	14WLI-G600	14WLI-R600

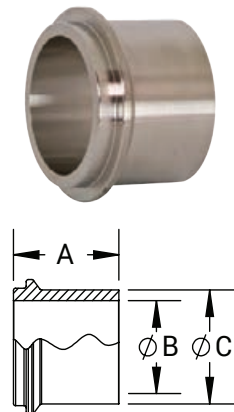

Male I-Line Heavy Wall Tank Weld Ferrules - 14WHI

Tube O.D.	A (in)	B (in)	C (in)	304 Stainless Steel Part #	316L Stainless Steel Part #
1"	1.50	.87	1.25	14WHI-G100	14WHI-R100
1-1/2"	1.63	1.37	1.69	14WHI-G150	14WHI-R150
2"	1.75	1.87	2.25	14WHI-G200	14WHI-R200
2-1/2"	1.75	2.37	2.75	14WHI-G250	14WHI-R250
3"	1.81	2.87	3.31	14WHI-G300	14WHI-R300
4"	2.13	3.83	4.25	14WHI-G400	14WHI-R400
6"	3.00	5.78	6.88	---	14WHI-R600

M



## I-Line/Q-Line - Ferrules

## Female I-Line Short Weld Ferrules - 15WI

  
63-04

Tube O.D.	A (in)	B (in)	C (in)	304 Stainless Steel Part #	316L Stainless Steel Part #
1"	.79	.25	1.00	15WI-G100	15WI-R100
1-1/2"	.95	.25	1.50	15WI-G150	15WI-R150
2"	1.04	.31	2.00	15WI-G200	15WI-R200
2-1/2"	1.16	.36	2.50	15WI-G250	15WI-R250
3"	1.22	.36	3.00	15WI-G300	15WI-R300
4"	1.35	.36	4.00	15WI-G400	15WI-R400
6"	1.13	.24	6.00	---	15WI-R600
8"	1.13	.24	8.00	---	15WI-R800

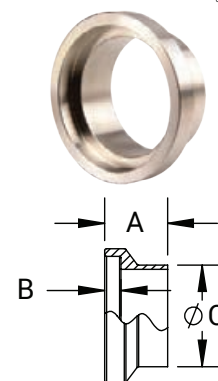

## Female I-Line Long Weld Ferrules - 15WLI

  
63-04

Tube O.D.	A (in)	B (in)	C (in)	304 Stainless Steel Part #	316L Stainless Steel Part #
1"	1.75	.25	1.00	15WLI-G100	15WLI-R100
1-1/2"	2.03	.25	1.50	15WLI-G150	15WLI-R150
2"	2.31	.31	2.00	15WLI-G200	15WLI-R200
2-1/2"	2.50	.36	2.50	15WLI-G250	15WLI-R250
3"	2.69	.36	3.00	15WLI-G300	15WLI-R300
4"	3.00	.36	4.00	15WLI-G400	15WLI-R400
6"	3.00	.24	6.00	---	15WLI-R600

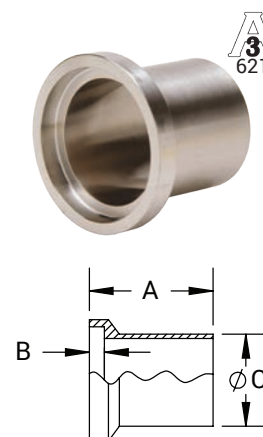

## Female I-Line Heavy Wall Tank Weld Ferrules - 15WHI

  
63-04

Tube O.D.	A (in)	B (in)	C (in)	304 Stainless Steel Part #	316L Stainless Steel Part #
1"	1.50	.87	1.25	15WHI-G100	15WHI-R100
1-1/2"	1.63	1.37	1.69	15WHI-G150	15WHI-R150
2"	1.75	1.87	2.25	15WHI-G200	15WHI-R200
2-1/2"	1.75	2.37	2.75	15WHI-G250	15WHI-R250
3"	1.81	2.87	3.31	15WHI-G300	15WHI-R300
4"	2.13	3.83	4.25	15WHI-G400	15WHI-R400

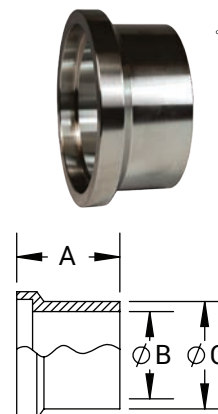

M

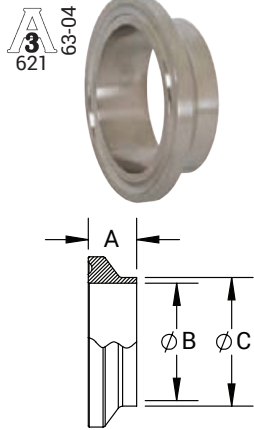

I-Line/Q-Line - Ferrules

Q-Line Weld Ferrules - 14WQ

Tube O.D.	A (in)	B (in)	C (in)	304 Stainless Steel Part #
1"	.53	.87	1.00	14WQ-G100
1-1/2"	.56	1.37	1.50	14WQ-G150
2"	.81	1.87	2.00	14WQ-G200
2-1/2"	.94	2.37	2.50	14WQ-G250
3"	.94	2.87	3.00	14WQ-G300
4"	1.00	3.83	4.00	14WQ-G400

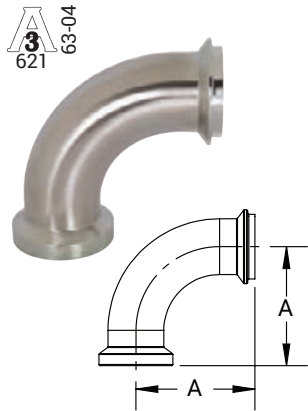

90° Female I-Line x Male I-Line Elbows - B2FI

Tube O.D.	A (in)	304 Stainless Steel Part #
1"	2.29	B2FI-G100
1-1/2"	3.20	B2FI-G150
2"	4.04	B2FI-G200
2-1/2"	4.91	B2FI-G250
3"	5.72	B2FI-G300
4"	7.35	B2FI-G400

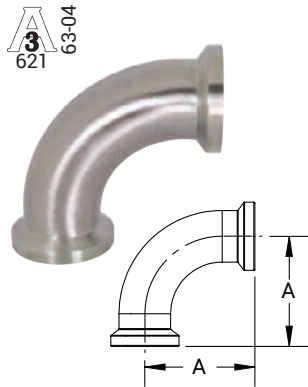

90° Female I-Line Elbows - B2CI

Tube O.D.	A (in)	304 Stainless Steel Part #
1"	2.29	B2CI-G100
1-1/2"	3.20	B2CI-G150
2"	4.04	B2CI-G200
2-1/2"	4.91	B2CI-G250
3"	5.72	B2CI-G300
4"	7.35	B2CI-G400



90° Male I-Line Elbows - B2EI

Tube O.D.	A (in)	304 Stainless Steel Part #
1"	2.29	B2EI-G100
1-1/2"	3.20	B2EI-G150
2"	4.04	B2EI-G200
2-1/2"	4.91	B2EI-G250
3"	5.72	B2EI-G300
4"	7.35	B2EI-G400

M

## I-Line / Q-Line - End Caps

## Male I-Line Solid End Caps - 16AI-14I

Tube O.D.	A (in)	304 Stainless Steel Part #	316L Stainless Steel Part #
1"	1.25	16AI-14I100	16AI-14I100R
1-1/2"	1.74	16AI-14I150	16AI-14I150R
2"	2.24	16AI-14I200	16AI-14I200R
2-1/2"	2.74	16AI-14I250	16AI-14I250R
3"	3.30	16AI-14I300	16AI-14I300R
4"	4.30	16AI-14I400	16AI-14I400R
6"	6.83	16AI-14I600	16AI-14I600R
8"	8.83	---	16AI-14I800R

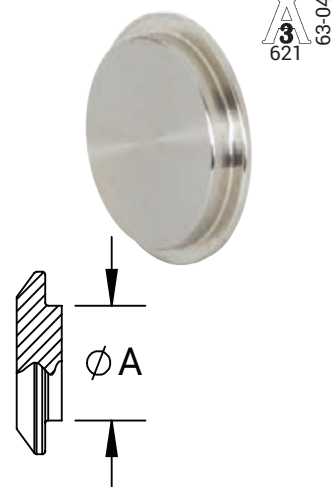

## Female I-Line Solid End Caps - 16AI-15I

Tube O.D.	A (in)	304 Stainless Steel Part #	316L Stainless Steel Part #
1"	1.27	16AI-15I100	16AI-15I100R
1-1/2"	1.76	16AI-15I150	16AI-15I150R
2"	2.26	16AI-15I200	16AI-15I200R
2-1/2"	2.76	16AI-15I250	16AI-15I250R
3"	3.32	16AI-15I300	16AI-15I300R
4"	4.32	16AI-15I400	16AI-15I400R
6"	6.92	16AI-15I600	16AI-15I600R
8"	8.92	---	16AI-15I800R

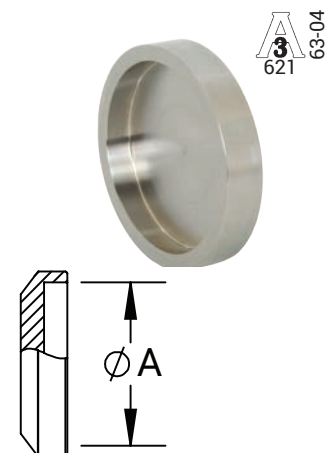

M

## Q-Line Solid End Caps - 16AQ

Tube O.D.	A (in)	304 Stainless Steel Part #
1"	0.19	16AQ-G100
1-1/2"	0.19	16AQ-G150
2"	0.25	16AQ-G200
2-1/2"	0.26	16AQ-G250
3"	0.26	16AQ-G300
4"	0.25	16AQ-G400

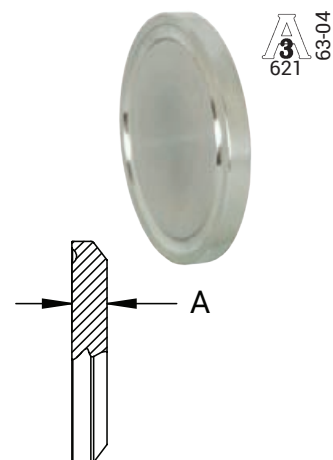

I-Line/Q-Line Adapters

**A**  
3  
621 63-04

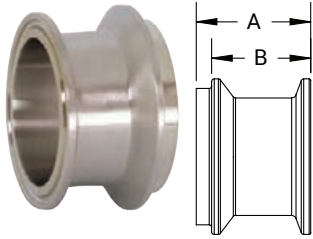

Male I-Line x Clamp Adapters - 17-14I-14MP

Tube O.D.	A (in)	B (in)	304 Stainless Steel Part #
1"	1.29	1.10	17-14I-14MPG100
1-1/2"	1.45	1.26	17-14I-14MPG150
2"	1.54	1.29	17-14I-14MPG200
2-1/2"	1.66	1.35	17-14I-14MPG250
3"	1.72	1.41	17-14I-14MPG300
4"	1.98	1.67	17-14I-14MPG400

**A**  
3  
621 63-04

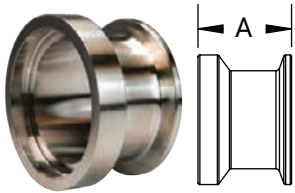

Female I-Line x Clamp Adapters - 17-15I-14MP

Tube O.D.	A (in)	304 Stainless Steel Part #
1"	1.28	17-15I-14MPG100
1-1/2"	1.45	17-15I-14MPG150
2"	1.54	17-15I-14MPG200
2-1/2"	1.63	17-15I-14MPG250
3"	1.72	17-15I-14MPG300
4"	1.97	17-15I-14MPG400

## John Perry Nuts

### Union Hex Nuts - 13H

Tube O.D.	A (in)	B (in)	304 Stainless Steel (CF8) Part #
1"	.91	1.81	13H-G100
1-1/2"	.97	2.41	13H-G150
2"	1.06	3.00	13H-G200
2-1/2"	1.19	3.59	13H-G250
3"	1.28	4.19	13H-G300
4"	1.50	5.44	13H-G400

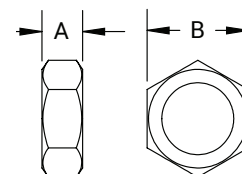

## John Perry Wrenches

### Single-Side Hex Wrenches - 25H

Tube O.D.	A (in)	B (in)	Weight lbs.	Aluminum Part #
1"	10.50	1.81	.64	25H-100
1-1/2"	12.00	2.41	.86	25H-150
2"	14.00	3.00	1.76	25H-200
2-1/2"	16.25	3.59	2.40	25H-250
3"	18.50	4.19	3.04	25H-300
4"	19.50	5.44	3.62	25H-400

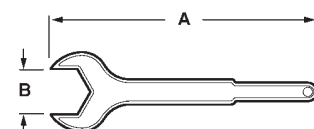

### Two-Sided Hex Wrenches - 25H

Tube O.D.	A (in)	B (in)	C (in)	Weight lbs.	Aluminum Part #
1-1/2" x 1"	12.00	2.41	1.81	1.00	25H-150100
2" x 1-1/2"	14.00	3.00	2.41	1.75	25H-200150
2-1/2" x 2"	16.50	3.59	3.00	2.80	25H-250200
3" x 2"	18.00	4.19	3.00	3.20	25H-300200
3" x 2-1/2"	18.00	4.19	3.59	3.70	25H-300250

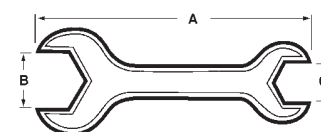

John Perry Ferrules

3  
621  
63-04

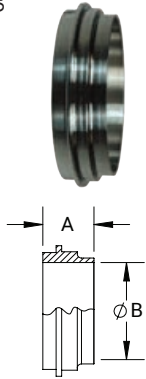

John Perry Short Plain Weld Ferrules - 14PRFJP

Tube O.D.	A (in)	B (in)	304 Stainless Steel Part #	316L Stainless Steel Part #
1"	.69	.87	14PRFJP-G100	14PRFJP-R100
1-1/2"	.72	1.37	14PRFJP-G150	14PRFJP-R150
2"	.72	1.87	14PRFJP-G200	14PRFJP-R200
2-1/2"	.84	2.37	14PRFJP-G250	14PRFJP-R250
3"	.91	2.87	14PRFJP-G300	14PRFJP-R300
4"	1.22	3.83	14PRFJP-G400	14PRFJP-R400

3  
621  
63-04

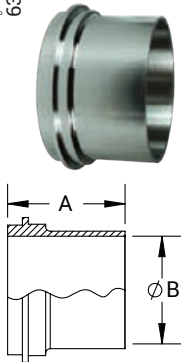

John Perry Long Plain Weld Ferrules - L14AJP

Tube O.D.	A (in)	B (in)	304 Stainless Steel Part #	316L Stainless Steel Part #
1"	1.38	.87	L14AJP-G100	L14AJP-R100
1-1/2"	1.50	1.37	L14AJP-G150	L14AJP-R150
2"	1.50	1.87	L14AJP-G200	L14AJP-R200
2-1/2"	1.75	2.37	L14AJP-G250	L14AJP-R250
3"	1.75	2.87	L14AJP-G300	L14AJP-R300
4"	1.75	3.83	L14AJP-G400	L14AJP-R400

M

3  
621  
63-04

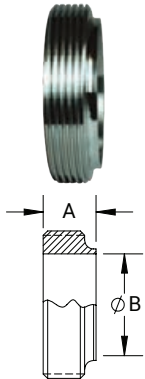

John Perry Threaded Short Weld Ferrules - 15TRFJP

Tube O.D.	A (in)	B (in)	304 Stainless Steel Part #	316L Stainless Steel Part #
1"	.69	.87	15TRFJP-G100	15TRFJP-R100
1-1/2"	.72	1.37	15TRFJP-G150	15TRFJP-R150
2"	.72	1.87	15TRFJP-G200	15TRFJP-R200
2-1/2"	.84	2.37	15TRFJP-G250	15TRFJP-R250
3"	.91	2.87	15TRFJP-G300	15TRFJP-R300
4"	1.22	3.83	15TRFJP-G400	15TRFJP-R400

3  
621  
63-04

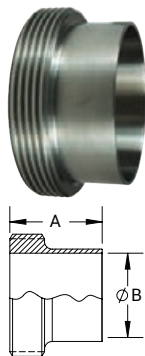

John Perry Threaded Long Weld Ferrules - L15AJP

Tube O.D.	A (in)	B (in)	304 Stainless Steel Part #	316L Stainless Steel Part #
1"	1.38	.87	L15AJP-G100	L15AJP-R100
1-1/2"	1.50	1.37	L15AJP-G150	L15AJP-R150
2"	1.50	1.87	L15AJP-G200	L15AJP-R200
2-1/2"	1.75	2.37	L15AJP-G250	L15AJP-R250
3"	1.75	2.87	L15AJP-G300	L15AJP-R300
4"	1.75	3.83	L15AJP-G400	L15AJP-R400

## John Perry End Caps

### John Perry Solid End Caps - 16AJP

Tube O.D.	A (in)	304 Stainless Steel Part #	316L Stainless Steel Part #
1"	.47	16AJP-G100	16AJP-R100
1-1/2"	.48	16AJP-G150	16AJP-R150
2"	.53	16AJP-G200	16AJP-R200
2-1/2"	.55	16AJP-G250	16AJP-R250
3"	.61	16AJP-G300	16AJP-R300
4"	.69	16AJP-G400	16AJP-R400

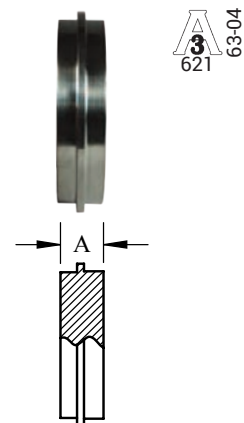

European Fittings - DIN

DIN Round Nuts - 13R

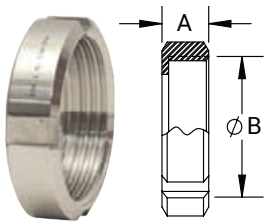

Nominal Size	A (mm)	B (mm)	304 Stainless Steel Part #
1"	21.0	Rd 52 x 1/6"	13R-G100DIN
1-1/2"	21.0	Rd 65 x 1/6"	13R-G150DIN
2"	22.0	Rd 78 x 1/6"	13R-G200DIN
2-1/2"	25.0	Rd 95 x 1/6"	13R-G250DIN
3"	29.0	Rd 110 x 1/4"	13R-G300DIN
4"	31.0	Rd 130 x 1/4"	13R-G400DIN

DIN Blank Caps - 16AMP

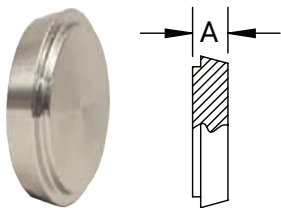

Nominal Size	A (mm)	316 Stainless Steel Part #
1"	13.0	16AMP-R100DIN
1-1/2"	13.0	16AMP-R150DIN
2"	14.0	16AMP-R200DIN
2-1/2"	16.0	16AMP-R250DIN
3"	16.0	16AMP-R300DIN
4"	20.0	16AMP-R400DIN

DIN x Tube O.D. Welding Male Adapters - 15A

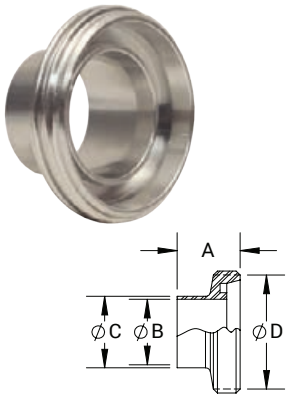

Nominal Size	A (mm)	B (mm)	C (mm)	D (mm)	316 Stainless Steel Part #
1"	29.0	22.1	25.4	Rd 52 x 1/6"	15A-R100DIN
1-1/2"	33.0	34.8	38.1	Rd 65 x 1/6"	15A-R150DIN
2"	35.0	47.5	50.8	Rd 78 x 1/6"	15A-R200DIN
2-1/2"	40.0	60.2	63.5	Rd 95 x 1/6"	15A-R250DIN
3"	45.0	72.9	76.2	Rd 110 x 1/4"	15A-R300DIN
4"	54.0	97.4	101.6	Rd 130 x 1/4"	15A-R400DIN

DIN x Tube O.D. Welding Liner Adapters - 14A

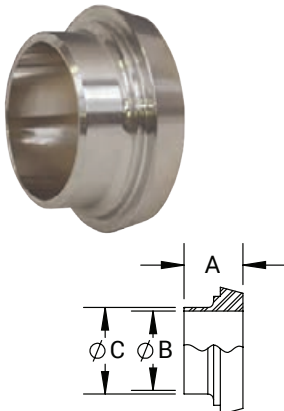

Nominal Size	A (mm)	B (mm)	C (mm)	316 Stainless Steel Part #
1"	22.0	22.1	25.4	14A-R100DIN
1-1/2"	26.0	34.8	38.1	14A-R150DIN
2"	28.0	47.5	50.8	14A-R200DIN
2-1/2"	32.0	60.2	63.5	14A-R250DIN
3"	37.0	72.9	76.2	14A-R300DIN
4"	44.0	97.4	101.6	14A-R400DIN

NOTE: Manufactured in accordance to Imperial DIN 11851

M



## SMS

## SMS Round Nuts - 13R

Nominal Size	A (mm)	B (mm)	304 Stainless Steel Part #
1"	19.0	Rd 40 x 1/6"	13R-G100SMS
1-1/2"	23.0	Rd 60 x 1/6"	13R-G150SMS
2"	24.0	Rd 70 x 1/6"	13R-G200SMS
2-1/2"	28.0	Rd 85 x 1/6"	13R-G250SMS
3"	30.0	Rd 98 x 1/6"	13R-G300SMS
4"	31.0	Rd 125 x 1/4"	13R-G400SMS

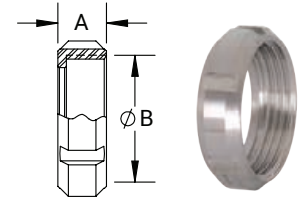

## SMS Blank Caps - 16AMP

Nominal Size	A (mm)	B (mm)	316 Stainless Steel Part #
1"	32.0	35.5	16AMP-R100SMS
1-1/2"	47.9	55.0	16AMP-R150SMS
2"	60.4	65.0	16AMP-R200SMS
2-1/2"	73.5	80.0	16AMP-R250SMS
3"	86.5	93.0	16AMP-R300SMS
4"	112.5	118.0	16AMP-R400SMS

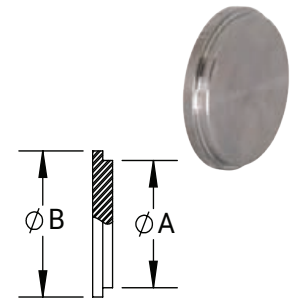

## SMS x Tube O.D. Adapters - 15A

Nominal Size	A (mm)	B (mm)	C (mm)	D (mm)	316 Stainless Steel Part #
1"	19.0	22.1	25.0	Rd 40 x 1/6"	15A-R100SMS
1-1/2"	23.0	34.8	38.0	Rd 60 x 1/6"	15A-R150SMS
2"	23.0	47.5	50.8	Rd 70 x 1/6"	15A-R200SMS
2-1/2"	27.0	60.2	63.5	Rd 85 x 1/6"	15A-R250SMS
3"	27.0	72.9	76.2	Rd 98 x 1/6"	15A-R300SMS
4"	30.0	97.4	101.6	Rd 125 x 1/4"	15A-R400SMS

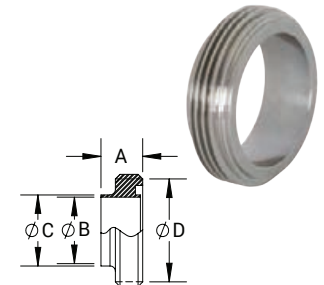

M

## SMS x Tube O.D. Welding Liners - 14A

Nominal Size	A (mm)	B (mm)	C (mm)	316 Stainless Steel Part #
1"	15.5	22.1	25.0	14A-R100SMS
1-1/2"	16.0	34.8	38.0	14A-R150SMS
2"	17.0	47.5	50.8	14A-R200SMS
2-1/2"	17.0	60.2	63.5	14A-R250SMS
3"	19.0	72.9	76.2	14A-R300SMS
4"	19.0	97.4	101.6	14A-R400SMS

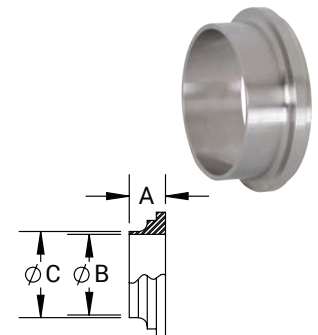

## DIN and SMS Spanner Wrenches - SP

Used On Nominal Size	A (mm)	Nickel Plated Steel Part #
1" - 1-1/2"	247.7	DIN-SMS-60/90SP
2" - 4"	330.2	DIN-SMS90/155SP

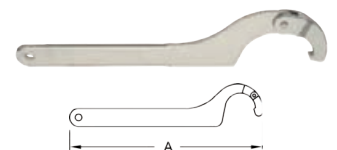

NOTE: Manufactured in accordance to Swedish Milk Standard ISO 2037 and ISO 2851

**European Fittings - RJT BS: 4825**

**RJT Hex Nuts - 13H**

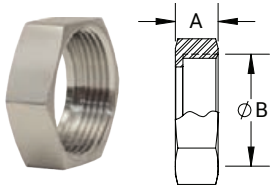

Nominal Size	A (mm)	B (mm)	304 Stainless Steel Part #
1"	22.2	42.3 x 8TPI WHIT	13H-G100RJT
1-1/2"	22.2	55.0 x 8TPI WHIT	13H-G150RJT
2"	22.2	67.9 x 6TPI WHIT	13H-G200RJT
2-1/2"	22.2	80.6 x 6TPI WHIT	13H-G250RJT
3"	22.2	93.3 x 6TPI WHIT	13H-G300RJT
4"	22.2	118.7 x 6TPI WHIT	13H-G400RJT

**RJT Blank Caps - 13RBN**

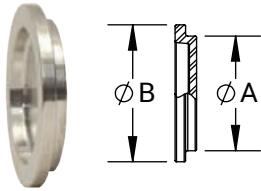

Nominal Size	A (mm)	B (mm)	304 Stainless Steel Part #
1"	32.5	41.3	13RBN-G100RJT
1-1/2"	45.2	54.0	13RBN-G150RJT
2"	57.9	66.7	13RBN-G200RJT
2-1/2"	70.6	79.4	13RBN-G250RJT
3"	83.3	92.1	13RBN-G300RJT
4"	108.7	117.5	13RBN-G400RJT

**RJT x Tube O.D. Adapters - 15A**

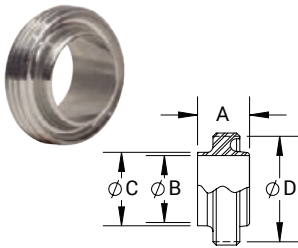

Nominal Size	A (mm)	B (mm)	C (mm)	D (mm)	316 Stainless Steel Part #
1"	27.0	22.1	25.65	45.7 x 8T	15A-R100RJT
1-1/2"	27.0	34.8	38.35	58.4 x 8T	15A-R150RJT
2"	27.0	47.5	50.8	72.7 x 6T	15A-R200RJT
2-1/2"	27.0	60.2	63.75	85.4 x 6T	15A-R250RJT
3"	27.0	72.9	76.2	98.1 x 6T	15A-R300RJT
4"	27.0	97.4	101.85	123.5 x 6T	15A-R400RJT

**RJT x Tube O.D. Welding Liners - 14A**

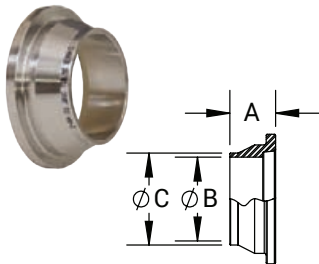

Nominal Size	A (mm)	B (mm)	C (mm)	316 Stainless Steel Part #
1"	19.5	22.1	25.65	14A-R100RJT
1-1/2"	19.5	34.8	38.35	14A-R150RJT
2"	19.5	47.5	50.8	14A-R200RJT
2-1/2"	19.5	60.2	63.75	14A-R250RJT
3"	19.5	72.9	76.2	14A-R300RJT
4"	19.5	97.4	101.85	14A-R400RJT

**RJT Spanner Wrenches - SP**

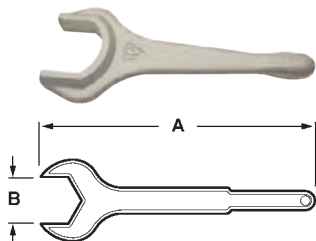

Size	A (mm)	B (mm)	Aluminum Part #
1"	254.00	50.80	RJT-100SP
1-1/2"	292.10	65.02	RJT-150SP
2"	304.80	79.25	RJT-200SP
2-1/2"	342.80	91.95	RJT-250SP
3"	368.30	104.65	RJT-300SP
4"	444.50	130.05	RJT-400SP

NOTE: Manufactured in accordance to BS 4825.

M

## High Purity BioPharm Fittings

## Solid End Caps - T16AMP

Tube O.D.	A (in)	PL Finish - SF1	PM Finish - SF4
1/2" - 3/4"	1.00	T16AMP-050075PL	T16AMP-050075PM
1" - 1-1/2"	1.99	T16AMP-100150PL	T16AMP-100150PM
2"	2.52	T16AMP-200PL	T16AMP-200PM
2-1/2"	3.05	T16AMP-250PL	T16AMP-250PM
3"	3.58	T16AMP-300PL	T16AMP-300PM
4"	4.69	T16AMP-400PL	T16AMP-400PM
6"	6.56	T16AMP-600PL	T16AMP-600PM

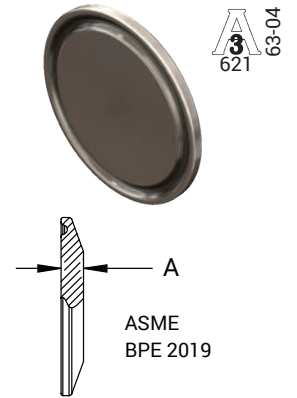

BPE Table DT-4.1.5-2

## Weld Caps - T16W

Tube O.D.	A (in)	PL Finish - SF1	PM Finish - SF4
1/2"	1.50	T16W-050PL	T16W-050PM
3/4"	1.50	T16W-075PL	T16W-075PM
1"	1.50	T16W-100PL	T16W-100PM
1-1/2"	1.50	T16W-150PL	T16W-150PM
2"	1.50	T16W-200PL	T16W-200PM
2-1/2"	1.50	T16W-250PL	T16W-250PM
3"	1.50	T16W-300PL	T16W-300PM
4"	2.00	T16W-400PL	T16W-400PM
6"	2.50	T16W-600PL	T16W-600PM

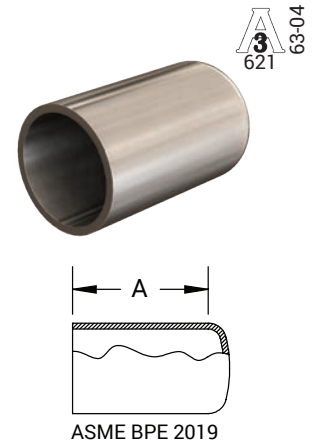

BPE Table DT-4.1.5-1

NOTE: BPE 2019 Specifications

PL Finish – SF1

O.D. = 32Ra Mechanically Polished

I.D. = 20Ra Mechanically Polished

PM Finish – SF4

O.D. = 32Ra Mechanically Polished

I.D. = 15Ra Mechanically Polished and Electropolished

**High Purity BioPharm Line**  
**Clamp Adapter x Male NPT - T21MP**

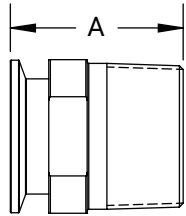

Clamp Size	NPT Thread Size	A (in)	PL Finish - SF1
1/2"	1/4"	2.00	T21MP-050025PL
	3/8"	2.00	T21MP-050375PL
	1/2"	1.63	T21MP-050PL
	3/4"	2.00	T21MP-050075PL
3/4"	1/4"	2.00	T21MP-075025PL
	3/8"	2.00	T21MP-075375PL
	1/2"	2.00	T21MP-075050PL
	3/4"	1.79	T21MP-075PL
1"	1/2"	2.19	T21MP-100050PL
	1"	2.25	T21MP-100PL
1-1/2"	1-1/2"	2.25	T21MP-150PL
2"	2"	2.64	T21MP-200PL
2-1/2"	2-1/2"	2.88	T21MP-250PL
3"	3"	3.07	T21MP-300PL
4"	4"	3.16	T21MP-400PL

**Clamp Adapter x Female NPT - T22MP**

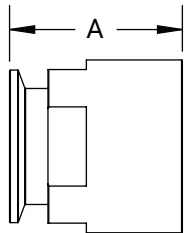

Clamp Size	NPT Thread Size	A (in)	PL Finish - SF1
1/2"	1/8"	1.25	T22MP-050125PL
	1/4"	1.50	T22MP-050025PL
	3/8"	1.50	T22MP-050375PL
	1/2"	1.50	T22MP-050PL
	3/4"	1.63	T22MP-050075PL
3/4"	1/4"	1.50	T22MP-075025PL
	3/8"	1.50	T22MP-075375PL
	1/2"	1.50	T22MP-075050PL
	3/4"	1.63	T22MP-075PL
1"	1"	1.63	T22MP-100PL
1-1/2"	1-1/2"	2.25	T22MP-150PL
2"	2"	2.34	T22MP-200PL
2-1/2"	2-1/2"	2.09	T22MP-250PL
3"	3"	2.19	T22MP-300PL
4"	4"	2.63	T22MP-400PL

**Stub Adapters - T14VB**

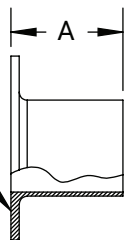

GROOVED  
STUB END

Tube O.D.	A (in)	PL Finish - SF1
1/2"	2.00	T14VB-050PL
3/4"	2.00	T14VB-075PL
1"	2.00	T14VB-100PL
1-1/2"	2.00	T14VB-150PL
2"	2.50	T14VB-200PL
2-1/2"	2.50	T14VB-250PL
3"	2.50	T14VB-300PL
4"	2.50	T14VB-400PL
6"	3.00	T14VB-600PL

PL Finish – SF1  
 O.D. = 32Ra Mechanically Polished  
 I.D. = 20Ra Mechanically Polished

PM Finish – SF4  
 O.D. = 32Ra Mechanically Polished  
 I.D. = 15Ra Mechanically Polished and Electropolished

## High Purity BioPharm Fittings

### Automatic Weld Ferrules - TL14AM7

Tube O.D.	A (in)	B (in)	C (in)	PL Finish - SF1	PM Finish - SF4
1/2"	1.75	0.37	0.50	TL14AM7-050PL	TL14AM7-050PM
3/4"	1.75	0.62	0.75	TL14AM7-075PL	TL14AM7-075PM
1"	1.75	0.87	1.00	TL14AM7-100PL	TL14AM7-100PM
1-1/2"	1.75	1.37	1.50	TL14AM7-150PL	TL14AM7-150PM
2"	2.25	1.87	2.00	TL14AM7-200PL	TL14AM7-200PM
2-1/2"	2.25	2.37	2.50	TL14AM7-250PL	TL14AM7-250PM
3"	2.25	2.87	3.00	TL14AM7-300PL	TL14AM7-300PM
4"	2.25	3.83	4.00	TL14AM7-400PL	TL14AM7-400PM
6"	3.00	5.78	6.00	TL14AM7-600PL	TL14AM7-600PM

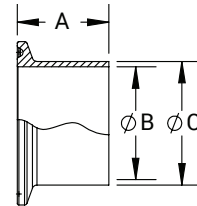
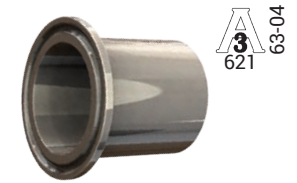

BPE Table DT-4.1.4-1  
ASME BPE 2019

63-04  
3  
621

### 90° Weld Elbows - T2S

Tube O.D.	A (in)	PL Finish - SF1	PM Finish - SF4
1/2"	3.00	T2S-050PL	T2S-050PM
3/4"	3.00	T2S-075PL	T2S-075PM
1"	3.00	T2S-100PL	T2S-100PM
1-1/2"	3.75	T2S-150PL	T2S-150PM
2"	4.75	T2S-200PL	T2S-200PM
2-1/2"	5.50	T2S-250PL	T2S-250PM
3"	6.25	T2S-300PL	T2S-300PM
4"	8.00	T2S-400PL	T2S-400PM
6"	11.50	T2S-600PL	T2S-600PM

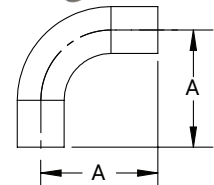

BPE Table DT-4.1.1-1  
ASME BPE 2019

63-04  
3  
621

### 90° Clamp x Weld Elbows - T2CM

Tube O.D.	A (in)	B (in)	PL Finish - SF1	PM Finish - SF4
1/2"	3.00	1.63	T2CM-050PL	T2CM-050PM
3/4"	3.00	1.63	T2CM-075PL	T2CM-075PM
1"	3.00	2.00	T2CM-100PL	T2CM-100PM
1-1/2"	3.75	2.75	T2CM-150PL	T2CM-150PM
2"	4.75	3.50	T2CM-200PL	T2CM-200PM
2-1/2"	5.50	4.25	T2CM-250PL	T2CM-250PM
3"	6.25	5.00	T2CM-300PL	T2CM-300PM
4"	8.00	6.63	T2CM-400PL	T2CM-400PM
6"	11.50	10.50	T2CM-600PL	T2CM-600PM

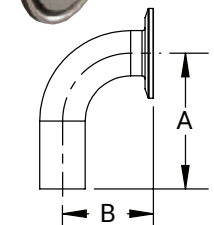

BPE Table DT-4.1.1-2  
ASME BPE 2019

63-04  
3  
621

### 90° Clamp x Clamp Elbows - T2CMP

Tube O.D.	A (in)	PL Finish - SF1	PM Finish - SF4
1/2"	1.63	T2CMP-050PL	T2CMP-050PM
3/4"	1.63	T2CMP-075PL	T2CMP-075PM
1"	2.00	T2CMP-100PL	T2CMP-100PM
1-1/2"	2.75	T2CMP-150PL	T2CMP-150PM
2"	3.50	T2CMP-200PL	T2CMP-200PM
2-1/2"	4.25	T2CMP-250PL	T2CMP-250PM
3"	5.00	T2CMP-300PL	T2CMP-300PM
4"	6.63	T2CMP-400PL	T2CMP-400PM
6"	10.50	T2CMP-600PL	T2CMP-600PM

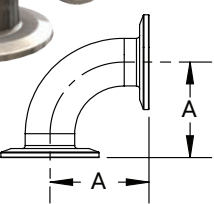

BPE Table DT-4.1.1-3  
ASME BPE 2019

63-04  
3  
621

NOTE: BPE 2019 Specifications

PL Finish – SF1

O.D. = 32Ra Mechanically Polished

I.D. = 20Ra Mechanically Polished

PM Finish – SF4

O.D. = 32Ra Mechanically Polished

I.D. = 15Ra Mechanically Polished and Electropolished

**High Purity BioPharm Fittings**

**45° Weld Elbows - T2KS**

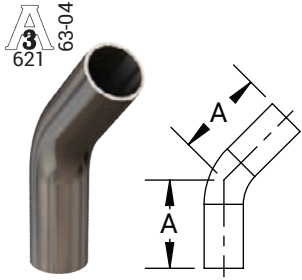

BPE Table DT-4.1.1-4  
ASME BPE 2019

Tube O.D.	A (in)	PL Finish - SF1	PM Finish - SF4
1/2"	2.25	T2KS-050PL	T2KS-050PM
3/4"	2.25	T2KS-075PL	T2KS-075PM
1"	2.25	T2KS-100PL	T2KS-100PM
1-1/2"	2.50	T2KS-150PL	T2KS-150PM
2"	3.00	T2KS-200PL	T2KS-200PM
2-1/2"	3.38	T2KS-250PL	T2KS-250PM
3"	3.63	T2KS-300PL	T2KS-300PM
4"	4.50	T2KS-400PL	T2KS-400PM
6"	6.25	T2KS-600PL	T2KS-600PM

**45° Clamp x Weld Elbows - T2KM**

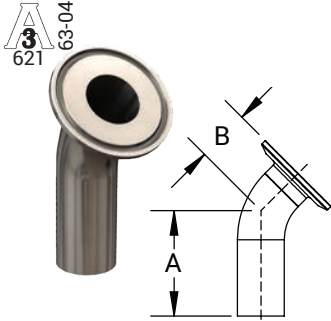

BPE Table DT-4.1.1-5  
ASME BPE 2019

Tube O.D.	A (in)	B (in)	PL Finish - SF1	PM Finish - SF4
1/2"	2.25	1.00	T2KM-050PL	T2KM-050PM
3/4"	2.25	1.00	T2KM-075PL	T2KM-075PM
1"	2.25	1.13	T2KM-100PL	T2KM-100PM
1-1/2"	2.50	1.44	T2KM-150PL	T2KM-150PM
2"	3.00	1.75	T2KM-200PL	T2KM-200PM
2-1/2"	3.38	2.06	T2KM-250PL	T2KM-250PM
3"	3.63	2.38	T2KM-300PL	T2KM-300PM
4"	4.50	3.13	T2KM-400PL	T2KM-400PM
6"	6.25	5.25	T2KM-600PL	T2KM-600PM

**45° Clamp x Clamp Elbows - T2KMP**

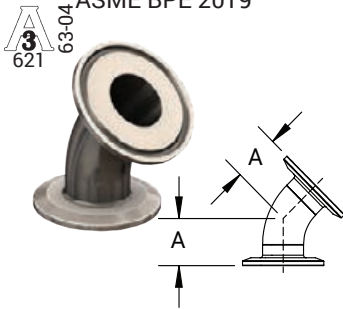

BPE Table DT-4.1.1-6  
ASME BPE 2019

Tube O.D.	A (in)	PL Finish - SF1	PM Finish - SF4
1/2"	1.00	T2KMP-050PL	T2KMP-050PM
3/4"	1.00	T2KMP-075PL	T2KMP-075PM
1"	1.13	T2KMP-100PL	T2KMP-100PM
1-1/2"	1.44	T2KMP-150PL	T2KMP-150PM
2"	1.75	T2KMP-200PL	T2KMP-200PM
2-1/2"	2.06	T2KMP-250PL	T2KMP-250PM
3"	2.38	T2KMP-300PL	T2KMP-300PM
4"	3.13	T2KMP-400PL	T2KMP-400PM
6"	5.25	T2KMP-600PL	T2KMP-600PM

**88° Weld Elbows - T2S88**



Tube O.D.	A (in)	R (in)	PL Finish - SF1	PM Finish - SF4
1/2"	1.94	1.06	T2S88-050PL	T2S88-050PM
3/4"	1.98	1.02	T2S88-075PL	T2S88-075PM
1"	1.50	1.50	T2S88-100PL	T2S88-100PM
1-1/2"	1.50	2.25	T2S88-150PL	T2S88-150PM
2"	1.75	3.00	T2S88-200PL	T2S88-200PM
2-1/2"	1.75	3.75	T2S88-250PL	T2S88-250PM
3"	1.75	4.50	T2S88-300PL	T2S88-300PM
4"	2.00	6.00	T2S88-400PL	T2S88-400PM
6"	2.50	9.00	T2S88-600PL	T2S88-600PM

**92° Weld Elbows - T2S92**

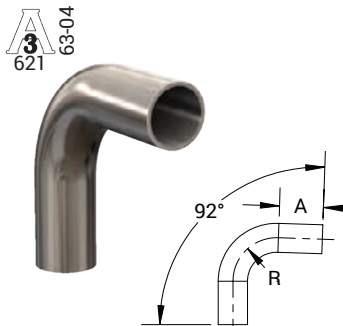

Tube O.D.	A (in)	R (in)	PL Finish - SF1	PM Finish - SF4
1/2"	1.94	1.06	T2S92-050PL	T2S92-050PM
3/4"	1.98	1.02	T2S92-075PL	T2S92-075PM
1"	1.50	1.50	T2S92-100PL	T2S92-100PM
1-1/2"	1.50	2.25	T2S92-150PL	T2S92-150PM
2"	1.75	3.00	T2S92-200PL	T2S92-200PM
2-1/2"	1.75	3.75	T2S92-250PL	T2S92-250PM
3"	1.75	4.50	T2S92-300PL	T2S92-300PM
4"	2.00	6.00	T2S92-400PL	T2S92-400PM
6"	2.50	9.00	T2S92-600PL	T2S92-600PM

NOTE: BPE 2019 Specifications  
 PL Finish – SF1  
 O.D. = 32Ra Mechanically Polished  
 I.D. = 20Ra Mechanically Polished  
 PM Finish – SF4  
 O.D. = 32Ra Mechanically Polished  
 I.D. = 15Ra Mechanically Polished and Electropolished

M

## High Purity BioPharm Fittings

## Weld x Weld x Weld Tees - T7WWW

Tube O.D.	A (in)	PL Finish - SF1	PM Finish - SF4
1/2"	1.88	T7WWW-050PL	T7WWW-050PM
3/4"	2.00	T7WWW-075PL	T7WWW-075PM
1"	2.13	T7WWW-100PL	T7WWW-100PM
1-1/2"	2.38	T7WWW-150PL	T7WWW-150PM
2"	2.88	T7WWW-200PL	T7WWW-200PM
2-1/2"	3.13	T7WWW-250PL	T7WWW-250PM
3"	3.38	T7WWW-300PL	T7WWW-300PM
4"	4.13	T7WWW-400PL	T7WWW-400PM
6"	5.63	T7WWW-600PL	T7WWW-600PM

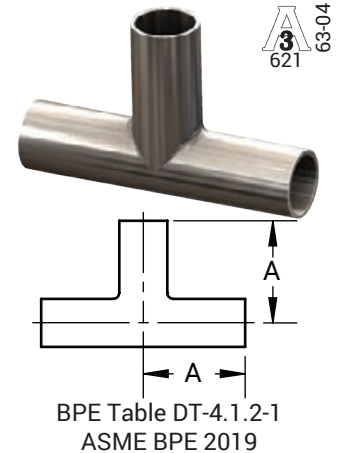

## Weld x Weld x Weld Reducing Tees - T7RWWW

Tube O.D.	A (in)	B (in)	PL Finish - SF1	PM Finish - SF4
3/4" x 1/2"	2.00	2.00	T7RWWW-075050PL	T7RWWW-075050PM
1" X 1/2"	2.13	2.13	T7RWWW-100050PL	T7RWWW-100050PM
1" X 3/4"	2.13	2.13	T7RWWW-10075PL	T7RWWW-10075PM
1-1/2" X 1/2"	2.38	2.38	T7RWWW-150050PL	T7RWWW-150050PM
1-1/2" X 3/4"	2.38	2.38	T7RWWW-150075PL	T7RWWW-150075PM
1-1/2" X 1"	2.38	2.38	T7RWWW-150100PL	T7RWWW-150100PM
2 X 1/2"	2.88	2.63	T7RWWW-200050PL	T7RWWW-200050PM
2" X 3/4"	2.88	2.63	T7RWWW-200075PL	T7RWWW-200075PM
2" X 1"	2.88	2.63	T7RWWW-200100PL	T7RWWW-200100PM
2" X 1-1/2"	2.88	2.63	T7RWWW-200150PL	T7RWWW-200150PM
2-1/2" X 1/2"	3.13	2.88	T7RWWW-250050PL	T7RWWW-250050PM
2-1/2" X 3/4"	3.13	2.88	T7RWWW-250075PL	T7RWWW-250075PM
2-1/2" X 1"	3.13	2.88	T7RWWW-250100PL	T7RWWW-250100PM
2-1/2" X 1-1/2"	3.13	2.88	T7RWWW-250150PL	T7RWWW-250150PM
2-1/2" X 2"	3.13	2.88	T7RWWW-250200PL	T7RWWW-250200PM
3" X 1/2"	3.38	3.13	T7RWWW-300050PL	T7RWWW-300050PM
3" X 3/4"	3.38	3.13	T7RWWW-300075PL	T7RWWW-300075PM
3" X 1"	3.38	3.13	T7RWWW-300100PL	T7RWWW-300100PM
3" X 1-1/2"	3.38	3.13	T7RWWW-300150PL	T7RWWW-300150PM
3" X 2"	3.38	3.13	T7RWWW-300200PL	T7RWWW-300200PM
3" X 2-1/2"	3.38	3.13	T7RWWW-300250PL	T7RWWW-300250PM
4" X 1/2"	4.13	3.63	T7RWWW-400050PL	T7RWWW-400050PM
4" X 3/4"	4.13	3.63	T7RWWW-400075PL	T7RWWW-400075PM
4" X 1"	4.13	3.63	T7RWWW-400100PL	T7RWWW-400100PM
4" X 1-1/2"	4.13	3.63	T7RWWW-400150PL	T7RWWW-400150PM
4" X 2"	4.13	3.88	T7RWWW-400200PL	T7RWWW-400200PM
4" X 2-1/2"	4.13	3.88	T7RWWW-400250PL	T7RWWW-400250PM
4" X 3"	4.13	3.88	T7RWWW-400300PL	T7RWWW-400300PM
6" X 3"	5.63	4.88	T7RWWW-600300PL	T7RWWW-600300PM
6" X 4"	5.63	5.13	T7RWWW-600400PL	T7RWWW-600400PM

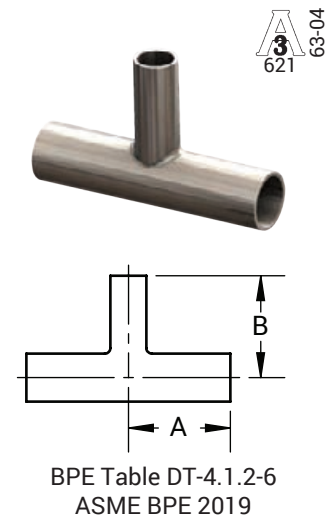

NOTE: BPE 2019 Specifications

PL Finish – SF1

O.D. = 32Ra Mechanically Polished

I.D. = 20Ra Mechanically Polished

PM Finish – SF4

O.D. = 32Ra Mechanically Polished

I.D. = 15Ra Mechanically Polished and Electropolished

High Purity BioPharm Fittings

3 63-04  
621

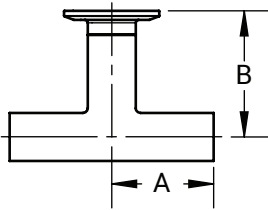
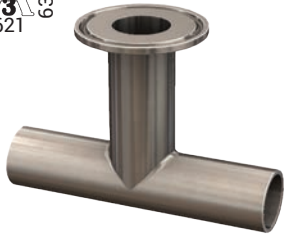

Weld x Weld x Clamp Tees - T7WWM

Tube O.D.	A (in)	B (in)	PL Finish - SF1	PM Finish - SF4
1/2"	1.88	2.25	T7WWM-050PL	T7WWM-050PM
3/4"	2.00	2.38	T7WWM-075PL	T7WWM-075PM
1"	2.13	2.63	T7WWM-100PL	T7WWM-100PM
1-1/2"	2.38	2.88	T7WWM-150PL	T7WWM-150PM
2"	2.88	3.38	T7WWM-200PL	T7WWM-200PM
2-1/2"	3.13	3.63	T7WWM-250PL	T7WWM-250PM
3"	3.38	3.88	T7WWM-300PL	T7WWM-300PM
4"	4.13	4.75	T7WWM-400PL	T7WWM-400PM
6"	5.63	7.13	T7WWM-600PL	T7WWM-600PM

3 63-04  
621

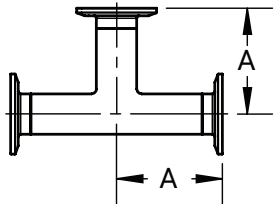

Clamp x Clamp x Clamp Tees - T7MP

Tube O.D.	A (in)	PL Finish - SF1	PM Finish - SF4
1/2"	2.38	T7MP-050PL	T7MP-050PM
3/4"	2.50	T7MP-075PL	T7MP-075PM
1"	2.63	T7MP-100PL	T7MP-100PM
1-1/2"	2.88	T7MP-150PL	T7MP-150PM
2"	3.38	T7MP-200PL	T7MP-200PM
2-1/2"	3.63	T7MP-250PL	T7MP-250PM
3"	3.88	T7MP-300PL	T7MP-300PM
4"	4.75	T7MP-400PL	T7MP-400PM
6"	7.13	T7MP-600PL	T7MP-600PM

M

BPE Table DT-4.1.2-4  
ASME BPE 2019

NOTE: BPE 2019 Specifications

PL Finish – SF1

O.D. = 32Ra Mechanically Polished

I.D. = 20Ra Mechanically Polished

PM Finish – SF4

O.D. = 32Ra Mechanically Polished

I.D. = 15Ra Mechanically Polished and Electropolished



## High Purity BioPharm Fittings

## Clamp x Clamp x Clamp Reducing Tees - T7RMP

  
63-04

Tube O.D.	A (in)	B (in)	PL Finish - SF1	PM Finish - SF4
3/4" x 1/2"	2.50	2.50	T7RMP-075050PL	T7RMP-075050PM
1" x 1/2"	2.63	2.63	T7RMP-100050PL	T7RMP-100050PM
1" x 3/4"	2.63	2.63	T7RMP-100075PL	T7RMP-100075PM
1-1/2" x 1/2"	2.88	2.88	T7RMP-150050PL	T7RMP-150050PM
1-1/2" x 3/4"	2.88	2.88	T7RMP-150075PL	T7RMP-150075PM
1-1/2" x 1"	2.88	2.88	T7RMP-150100PL	T7RMP-150100PM
2" x 1/2"	3.38	3.13	T7RMP-200050PL	T7RMP-200050PM
2" x 3/4"	3.38	3.13	T7RMP-200075PL	T7RMP-200075PM
2" x 1"	3.38	3.13	T7RMP-200100PL	T7RMP-200100PM
2" x 1-1/2"	3.38	3.13	T7RMP-200150PL	T7RMP-200150PM
2-1/2" x 1/2"	3.63	3.38	T7RMP-250050PL	T7RMP-250050PM
2-1/2" x 3/4"	3.63	3.38	T7RMP-250075PL	T7RMP-250075PM
2-1/2" x 1"	3.63	3.38	T7RMP-250100PL	T7RMP-250100PM
2-1/2" x 1-1/2"	3.63	3.38	T7RMP-250150PL	T7RMP-250150PM
2-1/2" x 2"	3.63	3.38	T7RMP-250200PL	T7RMP-250200PM
3" x 1/2"	3.88	3.63	T7RMP-300050PL	T7RMP-300050PM
3" x 3/4"	3.88	3.63	T7RMP-300075PL	T7RMP-300075PM
3" x 1"	3.88	3.63	T7RMP-300100PL	T7RMP-300100PM
3" x 1-1/2"	3.88	3.63	T7RMP-300150PL	T7RMP-300150PM
3" x 2"	3.88	3.63	T7RMP-300200PL	T7RMP-300200PM
3" x 2-1/2"	3.88	3.63	T7RMP-300250PL	T7RMP-300250PM
4" x 1/2"	4.75	4.13	T7RMP-400050PL	T7RMP-400050PM
4" x 3/4"	4.75	4.13	T7RMP-400075PL	T7RMP-400075PM
4" x 1"	4.75	4.13	T7RMP-400100PL	T7RMP-400100PM
4" x 1-1/2"	4.75	4.13	T7RMP-400150PL	T7RMP-400150PM
4" x 2"	4.75	4.38	T7RMP-400200PL	T7RMP-400200PM
4" x 2-1/2"	4.75	4.38	T7RMP-400250PL	T7RMP-400250PM
4" x 3"	4.75	4.38	T7RMP-400300PL	T7RMP-400300PM
6" x 3"	7.13	5.38	T7RMP-600300PL	T7RMP-600300PM
6" x 4"	7.13	5.75	T7RMP-600400PL	T7RMP-600400PM

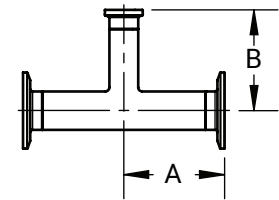
BPE Table DT-4.1.2-8  
ASME BPE 2019

M

## Weld x Weld x Clamp Short Outlet Tees - T7WWMS

  
63-04

Tube O.D.	A (in)	B (in)	PL Finish - SF1	PM Finish - SF4
1/2"	1.88	1.00	T7WWMS-050PL	T7WWMS-050PM
3/4"	2.00	1.13	T7WWMS-075PL	T7WWMS-075PM
1"	2.13	1.13	T7WWMS-100PL	T7WWMS-100PM
1-1/2"	2.38	1.38	T7WWMS-150PL	T7WWMS-150PM
2"	2.88	1.63	T7WWMS-200PL	T7WWMS-200PM
2-1/2"	3.13	1.88	T7WWMS-250PL	T7WWMS-250PM
3"	3.38	2.13	T7WWMS-300PL	T7WWMS-300PM
4"	4.13	2.75	T7WWMS-400PL	T7WWMS-400PM
6"	5.63	4.63	T7WWMS-600PL	T7WWMS-600PM

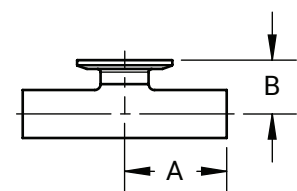
BPE Table DT-4.1.2-2  
ASME BPE 2019

NOTE: BPE 2019 Specifications

PL Finish – SF1

O.D. = 32Ra Mechanically Polished

I.D. = 20Ra Mechanically Polished

PM Finish – SF4

O.D. = 32Ra Mechanically Polished

I.D. = 15Ra Mechanically Polished and Electropolished

High Purity BioPharm Line

Weld x Weld x Clamp Short Outlet Reducing Tees - T7RWWMS

3 63-04  
621

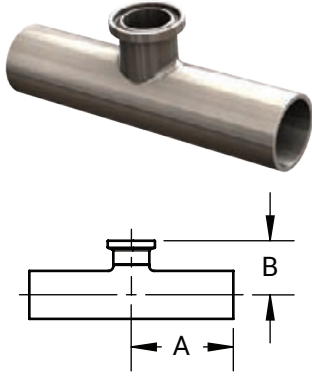

BPE Table DT-4.1.2-7  
ASME BPE 2019

Tube O.D.	A (in)	B (in)	PL Finish - SF1	PM Finish - SF4
3/4" x 1/2"	2.00	1.00	T7RWWMS075050PL	T7RWWMS075050PM
1" x 1/2"	2.13	1.13	T7RWWMS100050PL	T7RWWMS100050PM
1" x 3/4"	2.13	1.13	T7RWWMS100075PL	T7RWWMS100075PM
1-1/2" x 1/2"	2.38	1.38	T7RWWMS150050PL	T7RWWMS150050PM
1-1/2" x 3/4"	2.38	1.38	T7RWWMS150075PL	T7RWWMS150075PM
1-1/2" x 1"	2.38	1.38	T7RWWMS150100PL	T7RWWMS150100PM
2" x 1/2"	2.88	1.63	T7RWWMS200050PL	T7RWWMS200050PM
2" x 3/4"	2.88	1.63	T7RWWMS200075PL	T7RWWMS200075PM
2" x 1"	2.88	1.63	T7RWWMS200100PL	T7RWWMS200100PM
2" x 1-1/2"	2.88	1.63	T7RWWMS200150PL	T7RWWMS200150PM
2-1/2" x 1/2"	3.13	1.88	T7RWWMS250050PL	T7RWWMS250050PM
2-1/2" x 3/4"	3.13	1.88	T7RWWMS250075PL	T7RWWMS250075PM
2-1/2" x 1"	3.13	1.88	T7RWWMS250100PL	T7RWWMS250100PM
2-1/2" x 1-1/2"	3.13	1.88	T7RWWMS250150PL	T7RWWMS250150PM
2-1/2" x 2"	3.13	1.88	T7RWWMS250200PL	T7RWWMS250200PM
3" x 1/2"	3.38	2.13	T7RWWMS300050PL	T7RWWMS300050PM
3" x 3/4"	3.38	2.13	T7RWWMS300075PL	T7RWWMS300075PM
3" x 1"	3.38	2.13	T7RWWMS300100PL	T7RWWMS300100PM
3" x 1-1/2"	3.38	2.13	T7RWWMS300150PL	T7RWWMS300150PM
3" x 2"	3.38	2.13	T7RWWMS300200PL	T7RWWMS300200PM
3" x 2-1/2"	3.38	2.13	T7RWWMS300250PL	T7RWWMS300250PM
4" x 1/2"	4.13	2.63	T7RWWMS400050PL	T7RWWMS400050PM
4" x 3/4"	4.13	2.63	T7RWWMS400075PL	T7RWWMS400075PM
4" x 1"	4.13	2.63	T7RWWMS400100PL	T7RWWMS400100PM
4" x 1-1/2"	4.13	2.63	T7RWWMS400150PL	T7RWWMS400150PM
4" x 2"	4.13	2.63	T7RWWMS400200PL	T7RWWMS400200PM
4" x 2-1/2"	4.13	2.63	T7RWWMS400250PL	T7RWWMS400250PM
4" x 3"	4.13	2.63	T7RWWMS400300PL	T7RWWMS400300PM
6" x 3"	5.63	3.63	T7RWWMS600300PL	T7RWWMS600300PM
6" x 4"	5.63	3.75	T7RWWMS600400PL	T7RWWMS600400PM

M

3 63-04  
621

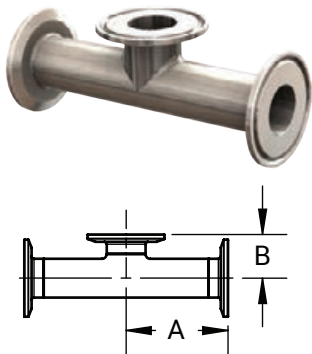

BPE Table DT-4.1.2-5  
ASME BPE 2019

Clamp x Clamp x Clamp Short Outlet Tees - T7MPS

Tube O.D.	A (in)	B (in)	PL Finish - SF1	PM Finish - SF4
1/2"	2.38	1.00	T7MPS-050PL	T7MPS-050PM
3/4"	2.50	1.13	T7MPS-075PL	T7MPS-075PM
1"	2.63	1.13	T7MPS-100PL	T7MPS-100PM
1-1/2"	2.88	1.38	T7MPS-150PL	T7MPS-150PM
2"	3.38	1.63	T7MPS-200PL	T7MPS-200PM
2-1/2"	3.63	1.88	T7MPS-250PL	T7MPS-250PM
3"	3.88	2.13	T7MPS-300PL	T7MPS-300PM
4"	4.75	2.75	T7MPS-400PL	T7MPS-400PM
6"	7.13	4.63	T7MPS-600PL	T7MPS-600PM

NOTE: BPE 2019 Specifications  
 PL Finish – SF1  
 O.D. = 32Ra Mechanically Polished  
 I.D. = 20Ra Mechanically Polished  
 PM Finish – SF4  
 O.D. = 32Ra Mechanically Polished  
 I.D. = 15Ra Mechanically Polished and Electropolished

## High Purity BioPharm Line

## Clamp x Clamp x Clamp Short Outlet Reducing Tees - T7RMPS

Tube O.D.	A (in)	B (in)	PL Finish - SF1	PM Finish - SF4
3/4" x 1/2"	2.50	1.00	T7RMPS-075050PL	T7RMPS-075050PM
1" x 1/2"	2.63	1.13	T7RMPS-100050PL	T7RMPS-100050PM
1" x 3/4"	2.63	1.13	T7RMPS-100075PL	T7RMPS-100075PM
1-1/2" x 1/2"	2.88	1.38	T7RMPS-150050PL	T7RMPS-150050PM
1-1/2" x 3/4"	2.88	1.38	T7RMPS-150075PL	T7RMPS-150075PM
1-1/2" x 1"	2.88	1.38	T7RMPS-150100PL	T7RMPS-150100PM
2" x 1/2"	3.38	1.63	T7RMPS-200050PL	T7RMPS-200050PM
2" x 3/4"	3.38	1.63	T7RMPS-200075PL	T7RMPS-200075PM
2" x 1"	3.38	1.63	T7RMPS-200100PL	T7RMPS-200100PM
2" x 1-1/2"	3.38	1.63	T7RMPS-200150PL	T7RMPS-200150PM
2-1/2" x 1/2"	3.63	1.88	T7RMPS-250050PL	T7RMPS-250050PM
2-1/2" x 3/4"	3.63	1.88	T7RMPS-250075PL	T7RMPS-250075PM
2-1/2" x 1"	3.63	1.88	T7RMPS-250100PL	T7RMPS-250100PM
2-1/2" x 1-1/2"	3.63	1.88	T7RMPS-250150PL	T7RMPS-250150PM
2-1/2" x 2"	3.63	1.88	T7RMPS-250200PL	T7RMPS-250200PM
3" x 1/2"	3.88	2.13	T7RMPS-300050PL	T7RMPS-300050PM
3" x 3/4"	3.88	2.13	T7RMPS-300075PL	T7RMPS-300075PM
3" x 1"	3.88	2.13	T7RMPS-300100PL	T7RMPS-300100PM
3" x 1-1/2"	3.88	2.13	T7RMPS-300150PL	T7RMPS-300150PM
3" x 2"	3.88	2.13	T7RMPS-300200PL	T7RMPS-300200PM
3" x 2-1/2"	3.88	2.13	T7RMPS-300250PL	T7RMPS-300250PM
4" x 1/2"	4.75	2.63	T7RMPS-400050PL	T7RMPS-400050PM
4" x 3/4"	4.75	2.63	T7RMPS-400075PL	T7RMPS-400075PM
4" x 1"	4.75	2.63	T7RMPS-400100PL	T7RMPS-400100PM
4" x 1-1/2"	4.75	2.63	T7RMPS-400150PL	T7RMPS-400150PM
4" x 2"	4.75	2.63	T7RMPS-400200PL	T7RMPS-400200PM
4" x 2-1/2"	4.75	2.63	T7RMPS-400250PL	T7RMPS-400250PM
4" x 3"	4.75	2.63	T7RMPS-400300PL	T7RMPS-400300PM
6" x 3"	7.13	3.63	T7RMPS-600300PL	T7RMPS-600300PM
6" x 4"	7.13	3.75	T7RMPS-600400PL	T7RMPS-600400PM

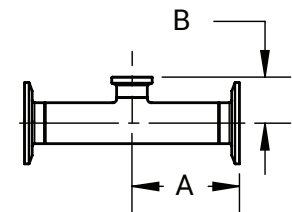
BPE Table DT-4.1.2-9  
ASME BPE 2019

## Weld x Weld x Clamp Instrument Tees - T7IWWMS

Tube O.D.	A (in)	B (in)	PL Finish - SF1	PM Finish - SF4
1/2" x 1-1/2"	2.50	.88	T7IWWMS050150PL	T7IWWMS050150PM
3/4" x 1-1/2"	2.50	1.00	T7IWWMS075150PL	T7IWWMS075150PM
1" x 1-1/2"	2.50	1.13	T7IWWMS100150PL	T7IWWMS100150PM
1/2" x 2"	2.75	1.00	T7IWWMS050200PL	T7IWWMS050200PM
3/4" x 2"	2.75	1.13	T7IWWMS075200PL	T7IWWMS075200PM
1" x 2"	2.75	1.25	T7IWWMS100200PL	T7IWWMS100200PM
1-1/2" x 2"	2.75	1.50	T7IWWMS150200PL	T7IWWMS150200PM

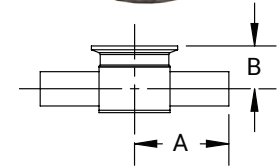
BPE Table DT-4.1.2-10  
ASME BPE 2019

## Clamp x Clamp x Clamp Instrument Tees - T7IMPS

Tube O.D.	A (in)	B (in)	PL Finish - SF1	PM Finish - SF4
1/2" x 1-1/2"	3.00	.88	T7IMPS-050150PL	T7IMPS-050150PM
3/4" x 1-1/2"	3.00	1.00	T7IMPS-075150PL	T7IMPS-075150PM
1" x 1-1/2"	3.00	1.13	T7IMPS-100150PL	T7IMPS-100150PM
1/2" x 2"	3.25	1.00	T7IMPS-050200PL	T7IMPS-050200PM
3/4" x 2"	3.25	1.13	T7IMPS-075200PL	T7IMPS-075200PM
1" x 2"	3.25	1.25	T7IMPS-100200PL	T7IMPS-100200PM
1-1/2" x 2"	3.25	1.50	T7IMPS150200PL	T7IMPS150200PM

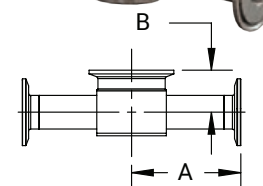
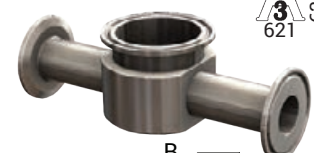
BPE Table DT-4.1.2-11  
ASME BPE 2019

NOTE: BPE 2019 Specifications

PL Finish – SF1

O.D. = 32Ra Mechanically Polished

I.D. = 20Ra Mechanically Polished

PM Finish – SF4

O.D. = 32Ra Mechanically Polished

I.D. = 15Ra Mechanically Polished and Electropolished

High Purity BioPharm Fittings

Weld x Weld Concentric Reducers – 2211C

A  
3  
621 63-04

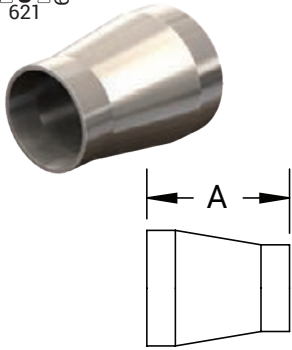

BPE Table DT-4.1.3-1  
ASME BPE 2019

Size	A (in)	PL finish - SF1	PM finish - SF4
3/4" x 1/2"	2.13	2211CBB075050F1	2211CBB075050F4
1" x 1/2"	2.50	2211CBB100050F1	2211CBB100050F4
1" x 3/4"	2.13	2211CBB100075F1	2211CBB100075F4
1-1/2" x 3/4"	3.00	2211CBB150075F1	2211CBB150075F4
1-1/2" x 1"	2.50	2211CBB150100F1	2211CBB150100F4
2" x 1"	3.38	2211CBB200100F1	2211CBB200100F4
2" x 1-1/2"	2.50	2211CBB200150F1	2211CBB200150F4
2-1/2" x 1-1/2"	3.38	2211CBB250150F1	2211CBB250150F4
2-1/2" x 2"	2.50	2211CBB250200F1	2211CBB250200F4
3" x 1-1/2"	4.25	2211CBB300150F1	2211CBB300150F4
3" x 2"	3.38	2211CBB300200F1	2211CBB300200F4
3" x 2-1/2"	2.63	2211CBB300250F1	2211CBB300250F4
4" x 2"	5.13	2211CBB400200F1	2211CBB400200F4
4" x 2-1/2"	4.25	2211CBB400250F1	2211CBB400250F4
4" x 3"	3.88	2211CBB400300F1	2211CBB400300F4
6" x 3"	7.25	2211CBB600300F1	2211CBB600300F4
6" x 4"	5.63	2211CBB600400F1	2211CBB600400F4

A  
3  
621 63-04

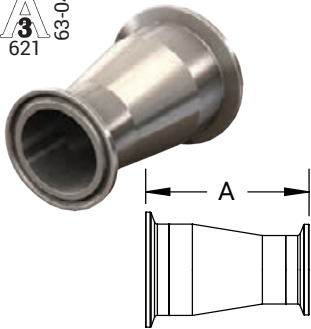

BPE Table DT-4.1.3-3  
ASME BPE 2019

Clamp x Clamp Concentric Reducers – 2221C

Size	A (in)	PL finish - SF1	PM finish - SF4
3/4" x 1/2"	3.13	2221CBB075050F1	2221CBB075050F4
1" x 1/2"	3.50	2221CBB100050F1	2221CBB100050F4
1" x 3/4"	3.13	2221CBB100075F1	2221CBB100075F4
1-1/2" x 3/4"	4.00	2221CBB150075F1	2221CBB150075F4
1-1/2" x 1"	3.50	2221CBB150100F1	2221CBB150100F4
2" x 1"	4.38	2221CBB200100F1	2221CBB200100F4
2" x 1-1/2"	3.50	2221CBB200150F1	2221CBB200150F4
2-1/2" x 1-1/2"	4.38	2221CBB250150F1	2221CBB250150F4
2-1/2" x 2"	3.50	2221CBB250200F1	2221CBB250200F4
3" x 1-1/2"	5.25	2221CBB300150F1	2221CBB300150F4
3" x 2"	4.38	2221CBB300200F1	2221CBB300200F4
3" x 2-1/2"	3.63	2221CBB300250F1	2221CBB300250F4
4" x 2"	6.25	2221CBB400200F1	2221CBB400200F4
4" x 2-1/2"	5.38	2221CBB400250F1	2221CBB400250F4
4" x 3"	5.00	2221CBB400300F1	2221CBB400300F4
6" x 3"	8.50	2221CBB600300F1	2221CBB600300F4
6" x 4"	7.00	2221CBB600400F1	2221CBB600400F4

NOTE: BPE 2019 Specifications

PL Finish – SF1

O.D. = 32Ra Mechanically Polished

I.D. = 20Ra Mechanically Polished

PM Finish – SF4

O.D. = 32Ra Mechanically Polished

I.D. = 15Ra Mechanically Polished and Electropolished

## High Purity BioPharm Fittings

## Weld x Weld Eccentric Reducers – 2211E

Size	A (in)	PL finish - SF1	PM finish - SF4
3/4" x 1/2"	2.13	2211EBB075050F1	2211EBB075050F4
1" x 1/2"	2.50	2211EBB100050F1	2211EBB100050F4
1" x 3/4"	2.13	2211EBB100075F1	2211EBB100075F4
1-1/2" x 3/4"	3.00	2211EBB150075F1	2211EBB150075F4
1-1/2" x 1"	2.50	2211EBB150100F1	2211EBB150100F4
2" x 1"	3.38	2211EBB200100F1	2211EBB200100F4
2" x 1-1/2"	2.50	2211EBB200150F1	2211EBB200150F4
2-1/2" x 1-1/2"	3.38	2211EBB250150F1	2211EBB250150F4
2-1/2" x 2"	2.50	2211EBB250200F1	2211EBB250200F4
3" x 1-1/2"	4.25	2211EBB300150F1	2211EBB300150F4
3" x 2"	3.38	2211EBB300200F1	2211EBB300200F4
3" x 2-1/2"	2.63	2211EBB300250F1	2211EBB300250F4
4" x 2"	5.13	2211EBB400200F1	2211EBB400200F4
4" x 2-1/2"	4.25	2211EBB400250F1	2211EBB400250F4
4" x 3"	3.88	2211EBB400300F1	2211EBB400300F4
6" x 3"	7.25	2211EBB600300F1	2211EBB600300F4
6" x 4"	5.63	2211EBB600400F1	2211EBB600400F4

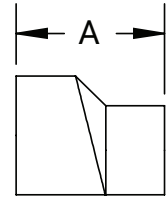

  
63-04
BPE Table DT-4.1.3-1  
ASME BPE 2019

## Clamp x Clamp Eccentric Reducers – 2221E

Size	A (in)	PL finish - SF1	PM finish - SF4
3/4" x 1/2"	3.13	2221EBB075050F1	2221EBB075050F4
1" x 1/2"	3.50	2221EBB100050F1	2221EBB100050F4
1" x 3/4"	3.13	2221EBB100075F1	2221EBB100075F4
1-1/2" x 3/4"	4.00	2221EBB150075F1	2221EBB150075F4
1-1/2" x 1"	3.50	2221EBB150100F1	2221EBB150100F4
2" x 1"	4.38	2221EBB200100F1	2221EBB200100F4
2" x 1-1/2"	3.50	2221EBB200150F1	2221EBB200150F4
2-1/2" x 1-1/2"	4.38	2221EBB250150F1	2221EBB250150F4
2-1/2" x 2"	3.50	2221EBB250200F1	2221EBB250200F4
3" x 1-1/2"	5.25	2221EBB300150F1	2221EBB300150F4
3" x 2"	4.38	2221EBB300200F1	2221EBB300200F4
3" x 2-1/2"	3.63	2221EBB300250F1	2221EBB300250F4
4" x 2"	6.25	2221EBB400200F1	2221EBB400200F4
4" x 2-1/2"	5.38	2221EBB400250F1	2221EBB400250F4
4" x 3"	5.00	2221EBB400300F1	2221EBB400300F4
6" x 3"	8.50	2221EBB600300F1	2221EBB600300F4
6" x 4"	7.00	2221EBB600400F1	2221EBB600400F4

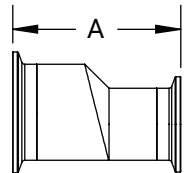

  
63-04
BPE Table DT-4.1.3-3  
ASME BPE 2019

NOTE: BPE 2019 Specifications

PL Finish – SF1

O.D. = 32Ra Mechanically Polished

I.D. = 20Ra Mechanically Polished

PM Finish – SF4

O.D. = 32Ra Mechanically Polished

I.D. = 15Ra Mechanically Polished and Electropolished

High Purity BioPharm Fittings

3 63-04  
621

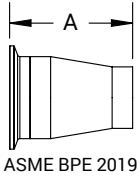

Clamp X Weld Concentric Reducers - 2226C

Tube O.D.	A (in)	PL Finish - SF1	PM Finish - SF4
3/4" x 1/2"	2.63	2226CBB075050F1	2226CBB075050F4
1" x 1/2"	3.00	2226CBB100050F1	2226CBB100050F4
1" x 3/4"	2.63	2226CBB100075F1	2226CBB100075F4
1-1/2" x 3/4"	3.50	2226CBB150075F1	2226CBB150075F4
1-1/2" x 1"	3.00	2226CBB150100F1	2226CBB150100F4
2" x 1"	3.88	2226CBB200100F1	2226CBB200100F4
2" x 1-1/2"	3.00	2226CBB200150F1	2226CBB200150F4
2-1/2" x 1-1/2"	3.88	2226CBB250150F1	2226CBB250150F4
2-1/2" x 2"	3.00	2226CBB250200F1	2226CBB250200F4
3" x 1-1/2"	4.75	2226CBB300150F1	2226CBB300150F4
3" x 2"	3.88	2226CBB300200F1	2226CBB300200F4
3" x 2-1/2"	3.13	2226CBB300250F1	2226CBB300250F4
4" x 2"	5.75	2226CBB400200F1	2226CBB400200F4
4" x 2-1/2"	4.88	2226CBB400250F1	2226CBB400250F4
4" x 3"	4.50	2226CBB400300F1	2226CBB400300F4

3 63-04  
621

M

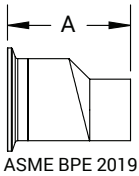

Clamp X Weld Eccentric Reducers - 2226E

Tube O.D.	A (in)	PL Finish - SF1	PM Finish - SF4
3/4" x 1/2"	2.63	2226EBB075050F1	2226EBB075050F4
1" x 1/2"	3.00	2226EBB100050F1	2226EBB100050F4
1" x 3/4"	2.63	2226EBB100075F1	2226EBB100075F4
1-1/2" x 3/4"	3.50	2226EBB150075F1	2226EBB150075F4
1-1/2" x 1"	3.00	2226EBB150100F1	2226EBB150100F4
2" x 1"	3.88	2226EBB200100F1	2226EBB200100F4
2" x 1-1/2"	3.00	2226EBB200150F1	2226EBB200150F4
2-1/2" x 1-1/2"	3.88	2226EBB250150F1	2226EBB250150F4
2-1/2" x 2"	3.00	2226EBB250200F1	2226EBB250200F4
3" x 1-1/2"	4.75	2226EBB300150F1	2226EBB300150F4
3" x 2"	3.88	2226EBB300200F1	2226EBB300200F4
3" x 2-1/2"	3.13	2226EBB300250F1	2226EBB300250F4
4" x 2"	5.75	2226EBB400200F1	2226EBB400200F4
4" x 2-1/2"	4.88	2226EBB400250F1	2226EBB400250F4
4" x 3"	4.50	2226EBB400300F1	2226EBB400300F4

NOTE: BPE 2019 Specifications

PL Finish – SF1

O.D. = 32Ra Mechanically Polished

I.D. = 20Ra Mechanically Polished

PM Finish – SF4

O.D. = 32Ra Mechanically Polished

I.D. = 15Ra Mechanically Polished and Electropolished

### High Purity BioPharm Fittings

#### Weld x Weld Concentric Reducers - T31W

 63-04  
621

Tube O.D.	A (in)	PL Finish - SF1	PM Finish - SF4
3/4" x 1/2"	4.00	T31W-075050PL	T31W-075050PM
1" x 1/2"	4.50	T31W-100050PL	T31W-100050PM
1" x 3/4"	4.00	T31W-100075PL	T31W-100075PM
1-1/2" x 1/2"	5.50	T31W-150050PL	T31W-150050PM
1-1/2" x 3/4"	5.00	T31W-150075PL	T31W-150075PM
1-1/2" x 1"	5.00	T31W-150100PL	T31W-150100PM
2" x 1/2"	7.75	T31W-200050PL	T31W-200050PM
2" x 3/4"	7.25	T31W-200075PL	T31W-200075PM
2" x 1"	7.25	T31W-200100PL	T31W-200100PM
2" x 1-1/2"	5.25	T31W-200150PL	T31W-200150PM
2-1/2" x 1/2"	9.75	T31W-250050PL	T31W-250050PM
2-1/2" x 3/4"	9.25	T31W-250075PL	T31W-250075PM
2-1/2" x 1"	9.25	T31W-250100PL	T31W-250100PM
2-1/2" x 1-1/2"	7.25	T31W-250150PL	T31W-250150PM
2-1/2" x 2"	5.50	T31W-250200PL	T31W-250200PM
3" x 1"	11.25	T31W-300100PL	T31W-300100PM
3" x 1-1/2"	9.25	T31W-300150PL	T31W-300150PM
3" x 2"	7.50	T31W-300200PL	T31W-300200PM
3" x 2-1/2"	5.50	T31W-300250PL	T31W-300250PM
4" x 1"	15.50	T31W-400100PL	T31W-400100PM
4" x 1-1/2"	13.50	T31W-400150PL	T31W-400150PM
4" x 2"	11.75	T31W-400200PL	T31W-400200PM
4" x 2-1/2"	9.75	T31W-400250PL	T31W-400250PM
4" x 3"	7.75	T31W-400300PL	T31W-400300PM
6" x 3"	10.00	T31W-600300PL	T31W-600300PM
6" x 4"	10.00	T31W-600400PL	T31W-600400PM

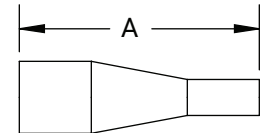

BPE Table DT-4.1.3-1(a)

#### Clamp x Weld Concentric Reducers - T31M

 63-04  
621

Tube O.D.	A (in)	PL Finish - SF1	PM Finish - SF4
3/4" x 1/2"	3.00	T31M-075050PL	T31M-075050PM
1" x 1/2"	3.50	T31M-100050PL	T31M-100050PM
1" x 3/4"	3.00	T31M-100075PL	T31M-100075PM
1-1/2" x 1/2"	4.50	T31M-150050PL	T31M-150050PM
1-1/2" x 3/4"	4.00	T31M-150075PL	T31M-150075PM
1-1/2" x 1"	4.00	T31M-150100PL	T31M-150100PM
2" x 1/2"	6.50	T31M-200050PL	T31M-200050PM
2" x 3/4"	6.00	T31M-200075PL	T31M-200075PM
2" x 1"	6.00	T31M-200100PL	T31M-200100PM
2" x 1-1/2"	4.00	T31M-200150PL	T31M-200150PM
2-1/2" x 1/2"	8.50	T31M-250050PL	T31M-250050PM
2-1/2" x 3/4"	8.00	T31M-250075PL	T31M-250075PM
2-1/2" x 1"	8.00	T31M-250100PL	T31M-250100PM
2-1/2" x 1-1/2"	6.00	T31M-250150PL	T31M-250150PM
2-1/2" x 2"	4.25	T31M-250200PL	T31M-250200PM
3" x 1"	10.00	T31M-300100PL	T31M-300100PM
3" x 1-1/2"	8.00	T31M-300150PL	T31M-300150PM
3" x 2"	6.25	T31M-300200PL	T31M-300200PM
3" x 2-1/2"	4.25	T31M-300250PL	T31M-300250PM
4" x 1"	14.13	T31M-400100PL	T31M-400100PM
4" x 1-1/2"	12.13	T31M-400150PL	T31M-400150PM
4" x 2"	10.38	T31M-400200PL	T31M-400200PM
4" x 2-1/2"	8.38	T31M-400250PL	T31M-400250PM
4" x 3"	6.38	T31M-400300PL	T31M-400300PM
6" x 3"	9.00	T31M-600300PL	T31M-600300PM
6" x 4"	9.00	T31M-600400PL	T31M-600400PM

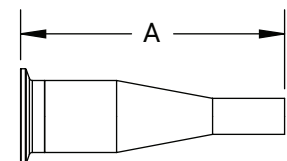

BPE Table DT-4.1.3-2(a)

NOTE: BPE 2016 Specifications

PL Finish – SF1

O.D. = 32Ra Mechanically Polished

I.D. = 20Ra Mechanically Polished

PM Finish – SF4

O.D. = 32Ra Mechanically Polished

I.D. = 15Ra Mechanically Polished and Electropolished



**High Purity BioPharm Fittings**

**Clamp x Clamp Concentric Reducers - T3114MP**

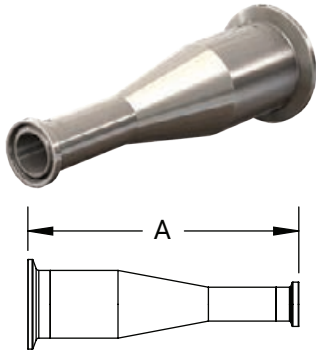

BPE Table DT-4.1.3-3(a)

Tube O.D.	A (in)	PL Finish - SF1	PM Finish - SF4
3/4" x 1/2"	2.00	T3114MP075050PL	T3114MP075050PM
1" x 1/2"	2.50	T3114MP100050PL	T3114MP100050PM
1" x 3/4"	2.00	T3114MP100075PL	T3114MP100075PM
1-1/2" x 1/2"	3.50	T3114MP150050PL	T3114MP150050PM
1-1/2" x 3/4"	3.00	T3114MP150075PL	T3114MP150075PM
1-1/2" x 1"	3.00	T3114MP150100PL	T3114MP150100PM
2" x 1/2"	5.50	T3114MP200050PL	T3114MP200050PM
2" x 3/4"	5.00	T3114MP200075PL	T3114MP200075PM
2" x 1"	5.00	T3114MP200100PL	T3114MP200100PM
2" x 1-1/2"	3.00	T3114MP200150PL	T3114MP200150PM
2-1/2" x 1/2"	7.50	T3114MP250050PL	T3114MP250050PM
2-1/2" x 3/4"	7.00	T3114MP250075PL	T3114MP250075PM
2-1/2" x 1"	7.00	T3114MP250100PL	T3114MP250100PM
2-1/2" x 1-1/2"	5.00	T3114MP250150PL	T3114MP250150PM
2-1/2" x 2"	3.00	T3114MP250200PL	T3114MP250200PM
3" x 1"	9.00	T3114MP300100PL	T3114MP300100PM
3" x 1-1/2"	7.00	T3114MP300150PL	T3114MP300150PM
3" x 2"	5.00	T3114MP300200PL	T3114MP300200PM
3" x 2-1/2"	3.00	T3114MP300250PL	T3114MP300250PM
4" x 1"	13.13	T3114MP400100PL	T3114MP400100PM
4" x 1-1/2"	11.13	T3114MP400150PL	T3114MP400150PM
4" x 2"	9.13	T3114MP400200PL	T3114MP400200PM
4" x 2-1/2"	7.13	T3114MP400250PL	T3114MP400250PM
4" x 3"	5.13	T3114MP400300PL	T3114MP400300PM
6" x 3"	7.50	T3114MP600300PL	T3114MP600300PM
6" x 4"	7.63	T3114MP600400PL	T3114MP600400PM



**Weld x Weld Eccentric Reducers - T32W**

**M**

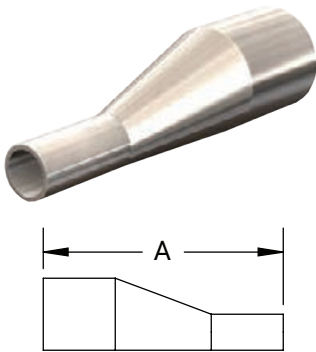

BPE Table DT-4.1.3-1(a)

Tube O.D.	A (in)	PL Finish - SF1	PM Finish - SF4
3/4" x 1/2"	4.00	T32W-075050PL	T32W-075050PM
1" x 1/2"	4.50	T32W-100050PL	T32W-100050PM
1" x 3/4"	4.00	T32W-100075PL	T32W-100075PM
1-1/2" x 1/2"	5.50	T32W-150050PL	T32W-150050PM
1-1/2" x 3/4"	5.00	T32W-150075PL	T32W-150075PM
1-1/2" x 1"	5.00	T32W-150100PL	T32W-150100PM
2" x 1/2"	7.75	T32W-200050PL	T32W-200050PM
2" x 3/4"	7.25	T32W-200075PL	T32W-200075PM
2" x 1"	7.25	T32W-200100PL	T32W-200100PM
2" x 1-1/2"	5.25	T32W-200150PL	T32W-200150PM
2-1/2" x 1/2"	9.75	T32W-250050PL	T32W-250050PM
2-1/2" x 3/4"	9.25	T32W-250075PL	T32W-250075PM
2-1/2" x 1"	9.25	T32W-250100PL	T32W-250100PM
2-1/2" x 1-1/2"	7.25	T32W-250150PL	T32W-250150PM
2-1/2" x 2"	5.50	T32W-250200PL	T32W-250200PM
3" x 1"	11.25	T32W-300100PL	T32W-300100PM
3" x 1-1/2"	9.25	T32W-300150PL	T32W-300150PM
3" x 2"	7.50	T32W-300200PL	T32W-300200PM
3" x 2-1/2"	5.50	T32W-300250PL	T32W-300250PM
4" x 1"	15.50	T32W-400100PL	T32W-400100PM
4" x 1-1/2"	13.50	T32W-400150PL	T32W-400150PM
4" x 2"	11.75	T32W-400200PL	T32W-400200PM
4" x 2-1/2"	9.75	T32W-400250PL	T32W-400250PM
4" x 3"	7.75	T32W-400300PL	T32W-400300PM
6" x 3"	9.75	T32W-600300PL	T32W-600300PM
6" x 4"	10.00	T32W-600400PL	T32W-600400PM

NOTE: BPE 2016 Specifications

PL Finish – SF1

O.D. = 32Ra Mechanically Polished

I.D. = 20Ra Mechanically Polished

PM Finish – SF4

O.D. = 32Ra Mechanically Polished

I.D. = 15Ra Mechanically Polished and Electropolished



### High Purity BioPharm Fittings

#### Clamp x Weld Eccentric Reducers - T32M

Tube O.D.	A (in)	PL Finish - SF1	PM Finish - SF4
3/4" x 1/2"	3.00	T32M-075050PL	T32M-075050PM
1" x 1/2"	3.50	T32M-100050PL	T32M-100050PM
1" x 3/4"	3.00	T32M-100075PL	T32M-100075PM
1-1/2" x 1/2"	4.50	T32M-150050PL	T32M-150050PM
1-1/2" x 3/4"	4.00	T32M-150075PL	T32M-150075PM
1-1/2" x 1"	4.00	T32M-150100PL	T32M-150100PM
2" x 1/2"	6.50	T32M-200050PL	T32M-200050PM
2" x 3/4"	6.00	T32M-200075PL	T32M-200075PM
2" x 1"	6.00	T32M-200100PL	T32M-200100PM
2" x 1-1/2"	4.00	T32M-200150PL	T32M-200150PM
2-1/2" x 1/2"	8.50	T32M-250050PL	T32M-250050PM
2 1/2" x 3/4"	8.00	T32M-250075PL	T32M-250075PM
2-1/2" x 1"	8.00	T32M-250100PL	T32M-250100PM
2-1/2" x 1-1/2"	6.00	T32M-250150PL	T32M-250150PM
2-1/2" x 2"	4.25	T32M-250200PL	T32M-250200PM
3" x 1"	10.00	T32M-300100PL	T32M-300100PM
3" x 1-1/2"	8.00	T32M-300150PL	T32M-300150PM
3" x 2"	6.25	T32M-300200PL	T32M-300200PM
3" x 2-1/2"	4.25	T32M-300250PL	T32M-300250PM
4" x 1"	14.13	T32M-400100PL	T32M-400100PM
4" x 1-1/2"	12.13	T32M-400150PL	T32M-400150PM
4" x 2"	10.38	T32M-400200PL	T32M-400200PM
4" x 2-1/2"	8.38	T32M-400250PL	T32M-400250PM
4" x 3"	6.38	T32M-400300PL	T32M-400300PM
6" x 3"	8.75	T32M-600300PL	T32M-600300PM
6" x 4"	9.00	T32M-600400PL	T32M-600400PM

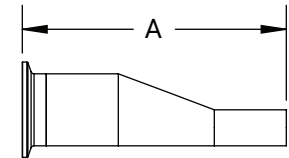

BPE Table DT-4.1.3-2(a)

### Clamp x Clamp Eccentric Reducers - T3214MP

Tube O.D.	A (in)	PL Finish - SF1	PM Finish - SF4
3/4" x 1/2"	2.00	T3214MP075050PL	T3214MP075050PM
1" x 1/2"	2.50	T3214MP100050PL	T3214MP100050PM
1" x 3/4"	2.00	T3214MP100075PL	T3214MP100075PM
1-1/2" x 1/2"	3.50	T3214MP150050PL	T3214MP150050PM
1-1/2" x 3/4"	3.00	T3214MP150075PL	T3214MP150075PM
1-1/2" x 1"	3.00	T3214MP150100PL	T3214MP150100PM
2" x 1/2"	5.50	T3214MP200050PL	T3214MP200050PM
2" x 3/4"	5.00	T3214MP200075PL	T3214MP200075PM
2" x 1"	5.00	T3214MP200100PL	T3214MP200100PM
2" x 1-1/2"	3.00	T3214MP200150PL	T3214MP200150PM
2-1/2" x 1/2"	7.50	T3214MP250050PL	T3214MP250050PM
2-1/2" x 3/4"	7.00	T3214MP250075PL	T3214MP250075PM
2-1/2" x 1"	7.00	T3214MP250100PL	T3214MP250100PM
2-1/2" x 1-1/2"	5.00	T3214MP250150PL	T3214MP250150PM
2-1/2" x 2"	3.00	T3214MP250200PL	T3214MP250200PM
3" x 1"	9.00	T3214MP300100PL	T3214MP300100PM
3" x 1-1/2"	7.00	T3214MP300150PL	T3214MP300150PM
3" x 2"	5.00	T3214MP300200PL	T3214MP300200PM
3" x 2-1/2"	3.00	T3214MP300250PL	T3214MP300250PM
4" x 1"	13.13	T3214MP400100PL	T3214MP400100PM
4" x 1-1/2"	11.13	T3214MP400150PL	T3214MP400150PM
4" x 2"	9.13	T3214MP400200PL	T3214MP400200PM
4" x 2-1/2"	7.13	T3214MP400250PL	T3214MP400250PM
4" x 3"	5.13	T3214MP400300PL	T3214MP400300PM
6" x 3"	7.63	T3214MP600300PL	T3214MP600300PM
6" x 4"	7.63	T3214MP600400PL	T3214MP600400PM

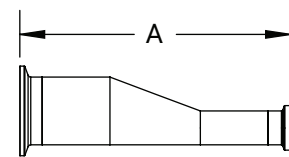

BPE Table DT-4.1.3-3(a)

NOTE: BPE 2016 Specifications

PL Finish – SF1

O.D. = 32Ra Mechanically Polished

I.D. = 20Ra Mechanically Polished

PM Finish – SF4

O.D. = 32Ra Mechanically Polished

I.D. = 15Ra Mechanically Polished and Electropolished

## Pipe Size Clamps

### Schedule 5S and 10S Single Pin Heavy Duty Clamps - 13MHHV

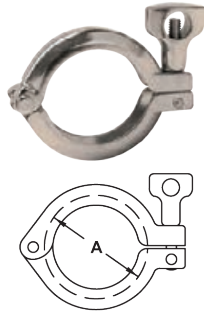

Pipe Size	A (in)	Service Pressure Rating PSI @ 70°F (21°C) <sup>1</sup>	Part #
1"	2.12	500	13MHHV100
1-1/2"	2.65	450	13MHHV150
2"	3.18	400	13MHHV200
2-1/2"	3.72	350	13MHHV250
3"	4.26	250	13MHHV300
4"	5.26	150	13MHHV400
6"	7.50	100	13MHHV600
8"	9.32	75	13MHHV800
10"	11.45	75	13MHHV1000

<sup>1</sup> Wing nut tightened to 25 in-lb of torque

### Schedule 5S and 10S Bolted Clamps - 13MHPV

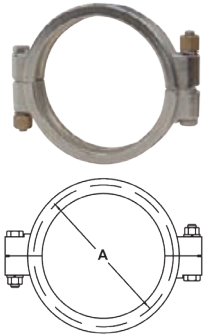

Pipe Size	A (in)	Service Pressure Rating PSI @ 70°F (21°C) <sup>1</sup>	Part #
1"	2.05	750	13MHPV100
1-1/2"	2.58	500	13MHPV150
2"	3.11	500	13MHPV200
2-1/2"	3.46	500	13MHPV250
3"	4.31	400	13MHPV300
4"	5.19	400	13MHPV400
6"	7.20	350	13MHPV600
8"	9.17	350	13MHPV800

<sup>1</sup> Bronze nuts tightened to 20 ft-lb of torque

## Pipe Size Ferrules

### Schedule 5S Short Weld Ferrules - 14WMV

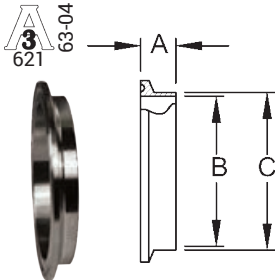

Pipe Size	A (in)	B (in)	C (in)	316L Stainless Steel Part #
1"	.50	1.19	1.32	14WMV-R100
1-1/2"	.50	1.77	1.90	14WMV-R150
2"	.50	2.25	2.38	14WMV-R200
2-1/2"	.50	2.71	2.88	14WMV-R250
3"	.50	3.33	3.50	14WMV-R300
4"	.63	4.33	4.50	14WMV-R400
6"	.88	6.41	6.63	14WMV-R600

### Schedule 10S Short Weld Ferrules - 14WMX

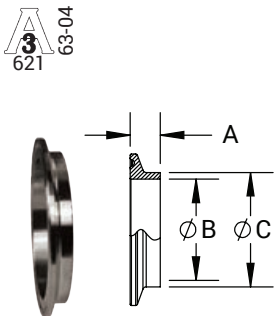

Pipe Size	A (in)	B (in)	C (in)	316L Stainless Steel Part #
1"	.50	1.10	1.32	14WMX-R100
1-1/2"	.50	1.68	1.90	14WMX-R150
2"	.50	2.16	2.38	14WMX-R200
2-1/2"	.50	2.64	2.88	14WMX-R250
3"	.50	3.26	3.50	14WMX-R300
4"	.63	4.26	4.50	14WMX-R400
6"	.88	6.36	6.63	14WMX-R600

NOTE: For additional information on pipe dimensions please reference [dixonvalve.com](http://dixonvalve.com).

## Pipe Size Ferrules

### Schedule 5S Long Weld Ferrules - L14AM7V

Pipe Size	A (in)	B (in)	C (in)	316L Stainless Steel Part #
1"	1.13	1.19	1.32	L14AM7V-R100
1-1/2"	1.13	1.77	1.90	L14AM7V-R150
2"	1.13	2.25	2.38	L14AM7V-R200
2-1/2"	1.13	2.71	2.88	L14AM7V-R250
3"	1.13	3.33	3.50	L14AM7V-R300
4"	1.13	4.33	4.50	L14AM7V-R400
6"	1.50	6.41	6.63	L14AM7V-R600

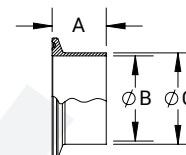
### Schedule 10S Long Weld Ferrules - L14AM7X

Pipe Size	A (in)	B (in)	C (in)	316L Stainless Steel Part #
1"	1.13	1.10	1.32	L14AM7X-R100
1-1/2"	1.13	1.68	1.90	L14AM7X-R150
2"	1.13	2.16	2.38	L14AM7X-R200
2-1/2"	1.13	2.64	2.88	L14AM7X-R250
3"	1.13	3.26	3.50	L14AM7X-R300
4"	1.13	4.26	4.50	L14AM7X-R400
6"	1.50	6.36	6.63	L14AM7X-R600

## Pipe Size End Caps

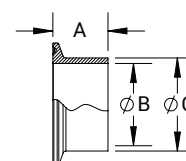
### Schedule 5S and 10S Solid End Caps - 16AMV

Pipe Size	A (in)	B (in)	304 Stainless Steel Part #	316L Stainless Steel Part #
1"	.25	1.98	16AMV-G100	16AMV-R100
1-1/2"	.25	2.52	16AMV-G150	16AMV-R150
2"	.25	3.05	16AMV-G200	16AMV-R200
2-1/2"	.25	3.60	16AMV-G250	16AMV-R250
3"	.31	4.13	16AMV-G300	16AMV-R300
4"	.31	5.13	16AMV-G400	16AMV-R400
6"	.44	7.20	16AMV-G600	16AMV-R600

NOTE: For additional information on pipe dimensions please reference [dixonvalve.com](http://dixonvalve.com).

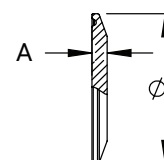
Pipe Size Adapters

3 63-04  
621

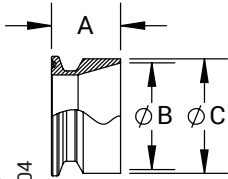

Tube O.D. Clamp x Schedule 5S Weld Adapters - B19MPV

Pipe Size	A (in)	B (in)	C (in)	Pipe Wall Thickness	316L Stainless Steel Part #
1"	1.13	1.19	1.32	.065	B19MPV-R100
1-1/2"	1.13	1.77	1.90	.065	B19MPV-R150
2"	1.13	2.25	2.38	.065	B19MPV-R200
2-1/2"	1.13	2.71	2.88	.083	B19MPV-R250
3"	1.13	3.33	3.50	.083	B19MPV-R300
4"	1.13	4.33	4.50	.083	B19MPV-R400

3 63-04  
621

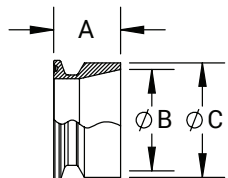

Tube O.D. Clamp x Schedule 10S Weld Adapters - B19MPX

Pipe Size	A (in)	B (in)	C (in)	Pipe Wall Thickness	316L Stainless Steel Part #
1"	1.13	1.10	1.32	.109	B19MPX-R100
1-1/2"	1.13	1.68	1.90	.109	B19MPX-R150
2"	1.13	2.16	2.38	.109	B19MPX-R200
2-1/2"	1.13	2.64	2.88	.120	B19MPX-R250
3"	1.13	3.26	3.50	.120	B19MPX-R300
4"	1.13	4.26	4.50	.120	B19MPX-R400

3 63-04  
621

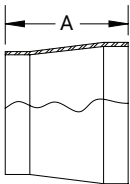
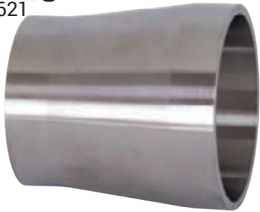

Tube O.D. Weld x Schedule 5S Weld Adapters - B19WV

Pipe Size	A (in)	Tube Wall Thickness	Pipe Wall Thickness	316L Stainless Steel Part #
1"	2.00	.07	.065	B19WV-R100
1-1/2"	2.50	.07	.065	B19WV-R150
2"	2.50	.07	.065	B19WV-R200
2-1/2"	2.50	.07	.083	B19WV-R250
3"	2.50	.07	.083	B19WV-R300
4"	3.00	.08	.083	B19WV-R400

3 63-04  
621

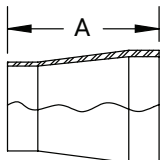
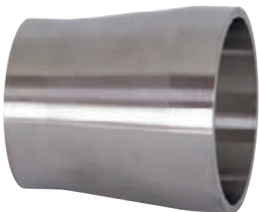

Tube O.D. Weld x Schedule 10S Weld Adapters - B19WX

Pipe Size	A (in)	Tube Wall Thickness	Pipe Wall Thickness	316L Stainless Steel Part #
1"	2.00	.07	.109	B19WX-R100
1-1/2"	2.50	.07	.109	B19WX-R150
2"	2.50	.07	.109	B19WX-R200
2-1/2"	2.50	.07	.120	B19WX-R250
3"	2.50	.07	.120	B19WX-R300
4"	3.00	.08	.120	B19WX-R400

M

## Pipe Size Hangers

### Hex Hanger with Rubber Grommets - B24RV<sup>1</sup>

Pipe Size	A (in)	B (in)	C (in)	304 Stainless Steel Part #
1/2"	3.38	2.25	1.00	B24RV-G50
3/4"	3.38	2.19	1.00	B24RV-G75
1"	3.70	2.20	1.00	B24RV-G100
1-1/2"	4.40	2.80	1.00	B24RV-G150
2"	5.00	3.30	1.00	B24RV-G200
2-1/2"	5.60	3.70	1.00	B24RV-G250
3"	6.10	4.30	1.00	B24RV-G300
4"	7.60	5.00	1.00	B24RV-G400
6"	9.80	7.20	1.50	B24RV-G600
8"	12.25	9.38	1.50	B24RV-G800

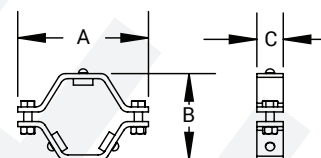

<sup>1</sup> For coupler options, call Dixon Sanitary at 800.789.1718

### Hex Hanger with Polypropylene Sleeves - B24PV<sup>1</sup>

Pipe Size	A (in)	B (in)	304 Stainless Steel Part #
1/2"	3.38	1.63	B24PV-G50
3/4"	3.38	1.63	B24PV-G75
1"	3.63	2.13	B24PV-G100
1-1/2"	4.31	2.63	B24PV-G150
2"	4.88	3.13	B24PV-G200
2-1/2"	4.88	3.13	B24PV-G250
3"	6.00	4.25	B24PV-G300
4"	7.50	5.63	B24PV-G400
5"	8.50	6.38	B24PV-G500
6"	9.75	7.38	B24PV-G600
8"	11.38	9.38	B24PV-G800

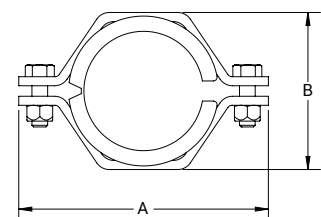

<sup>1</sup> For coupler options, call Dixon Sanitary at 800.789.1718

### Sleeves - 13PV

Pipe Size	Polypropylene Part #
3/4"	13PV-75
1"	13PV-100
1-1/2"	13PV-150
2"	13PV-200
2-1/2"	13PV-250
3"	13PV-300
4"	13PV-400
6"	13PV-600



NOTE: For additional information on pipe dimensions, please reference [dixonvalve.com](http://dixonvalve.com).

## Pipe Size Block Hangers



### Applications

- Clean rooms and mechanical areas; not limited to: biotech, pharmaceutical, food processing, beverage, dairy, cosmetic, chemical, water treatment, and semi-conductor industries.
- Low-flow and low-pressure systems with moderate vibration: WFI, SIP, CIP, process, utility, and instrument lines

### Sizes

- 1" - 4" standard; other sizes may be available upon request

### Features

- Insulation envelope: reduced O.D. allows hanger to be buried under the insulation jacket
- ZERO PUDDLE Silicone inserts raised geometry facilitates drainage of liquids on vertical/riser lines
- There are no exposed threads or openings in hardware plates

### Materials

- Silicone insert - 80 durometer; color: blue
- ZERO PUDDLE silicone rubber insert are available with FDA and UL ratings
- 304 stainless steel as standard; 316 available upon request

### Specification

- Intermittent temperatures from -40°F to 320°F (-40°C to 160°C)
- Continuous temperatures from -20°F to 285°F (-29°C to 140°C)

### Approvals

- All plates polished, bolts are cleaned, and nuts are lubricated with FDA-approved product
- Hanger threads match MSS SP-69 rod O.D. requirements



Hang Plate Block Hangers - B24V-HP

Pipe Size	Line O.D. (in)	H (in)	L (in)	W (in)	CL (in)	Thread	304 Stainless Steel Part #
1"	1.32	2.79	2.49	0.75	0.97	3/8"-16	B24V-HP-G100
1-1/2"	1.90	3.29	2.99	0.88	1.25	3/8"-16	B24V-HP-G150
2"	2.38	5.59	3.36	0.88	1.47	1/2"-13	B24V-HP-G200
2-1/2"	2.88	6.02	3.74	0.88	1.66	1/2"-13	B24V-HP-G250
3"	3.50	6.68	4.48	1.00	2.03	1/2"-13	B24V-HP-G300
4"	4.50	6.24	5.10	1.00	2.50	5/8"-11	B24V-HP-G400

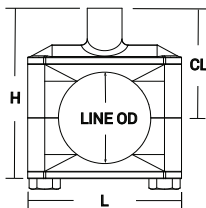

Weld Plate Block Hangers - B24V-WP

Pipe Size	Line O.D. (in)	H (in)	L (in)	W (in)	CL (in)	304 Stainless Steel Part #
1"	1.32	2.23	2.49	0.75	1.03	B24V-WP-G100
1-1/2"	1.90	2.75	2.99	0.88	1.31	B24V-WP-G150
2"	2.38	3.25	3.36	0.88	1.55	B24V-WP-G200
2-1/2"	2.88	3.68	3.74	0.88	1.70	B24V-WP-G250
3"	3.50	4.15	4.48	1.00	2.06	B24V-WP-G300
4"	4.50	5.27	5.10	1.00	2.58	B24V-WP-G400

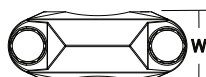
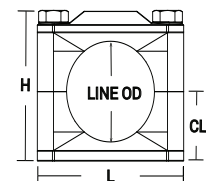

M

## Pipe Size Uni-Hinge Block Hangers

## Base Mount Block Hangers - B24V-BM

Pipe Size	Line O.D. (in)	H (in)	L (in)	W (in)	CL (in)	Round Coupling		304 Stainless Steel Part #
						Height (in)	Thread	
1"	1.312	2.19	2.49	.75	.97	.47	3/8"-16	B24V-BM-G100
1-1/2"	1.90	2.69	2.99	.88	1.25	.47	3/8"-16	B24V-BM-G150
2"	2.38	3.19	3.36	.88	1.49	.59	1/2"-13	B24V-BM-G200
2-1/2"	2.88	3.63	3.74	.88	1.71	.59	1/2"-13	B24V-BM-G250

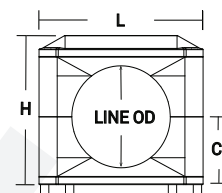

## Base Mount Block Hanger Threaded Couplings - B24V-BMTC

Pipe Size	Line O.D. (in)	H (in)	L (in)	W (in)	CL (in)	Round Coupling		304 Stainless Steel Part #
						Height (in)	Thread	
1"	1.312	2.19	2.49	.75	1.94	.47	3/8"-16	B24V-BM-G100
1-1/2"	1.90	2.69	2.99	.88	2.44	.47	3/8"-16	B24V-BM-G150
2"	2.38	3.19	3.36	.88	2.81	.59	1/2"-13	B24V-BM-G200
2-1/2"	2.88	3.63	3.74	.88	3.19	.59	1/2"-13	B24V-BM-G250

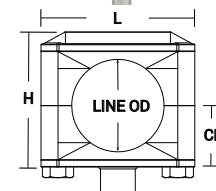
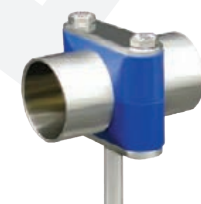

## Base Mount Block Hanger Rod Mounts - B24V-BMR6

Pipe Size	Line O.D. (in)	H (in)	L (in)	W (in)	CL (in)	Rod (stock length)		304 Stainless Steel Part #
						Length (in)	O.D.	
1"	1.32	2.19	2.49	.75	1.94	6.00	.38	B24V-BMR6-G100
1-1/2"	1.90	2.69	2.99	.88	2.44	6.00	.38	B24V-BMR6-G150
2"	2.38	3.19	3.36	.88	2.81	6.00	.50	B24V-BMR6-G200
2-1/2"	2.88	3.63	3.74	.88	3.19	6.00	.50	B24V-BMR6-G250

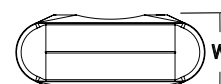
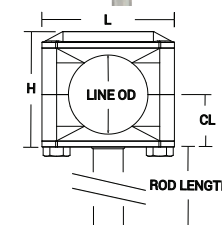

Pipe Size Uni-Hinge Block Hangers

Process Hex Hanger Weld Mounts - B24V-PH

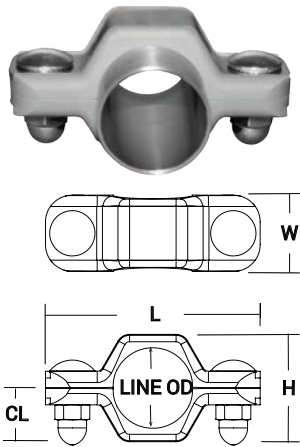

Pipe Size	Line O.D.	H (in)	L (in)	W (in)	CL (in)	304 Stainless Steel With Acorn Nut Part #	304 Stainless Steel With Lock Nut Part #
1"	1.32	1.96	4.00	1.42	0.98	B24V-PH-G100	B24V-PHL-G100
1-1/2"	1.90	2.50	4.60	1.42	1.25	B24V-PH-G150	B24V-PHL-G150
2"	2.38	3.00	5.10	1.42	1.50	B24V-PH-G200	B24V-PHL-G200
2-1/2"	2.88	3.50	5.60	1.42	1.75	B24V-PH-G250	B24V-PHL-G250
3"	3.50	4.13	6.33	1.42	2.06	B24V-PH-G300	B24V-PHL-G300
4"	4.50	5.12	7.52	1.42	2.65	B24V-PH-G400	B24V-PHL-G400

Process Hex Hanger Weld Mount Threaded Couplings - B24V-PHC

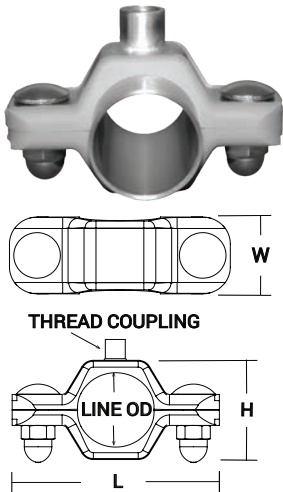

Pipe Size	Line O.D. (in)	H (in)	L (in)	W (in)	Height (in)	Thread (in)	304 Stainless Steel With Acorn Nut Part #	304 Stainless Steel With Lock Nut Part #
1"	1.32	1.96	4.00	1.42	0.47	3/8"-16	B24V-PHC-G100	B24V-PHCL-G100
1-1/2"	1.90	2.50	4.60	1.42	0.47	3/8"-16	B24V-PHC-G150	B24V-PHCL-G150
2"	2.38	3.00	5.10	1.42	0.59	1/2"-13	B24V-PHC-G200	B24V-PHCL-G200
2-1/2"	2.88	3.50	5.60	1.42	0.59	1/2"-13	B24V-PHC-G250	B24V-PHCL-G250
3"	3.50	4.13	6.33	1.42	0.59	1/2"-13	B24V-PHC-G300	B24V-PHCL-G300
4"	4.50	5.12	7.52	1.42	0.59	1/2"-13	B24V-PHC-G400	B24V-PHCL-G400

Process Hex Hanger Weld Mounts Rod Attached - B24V-PHR6

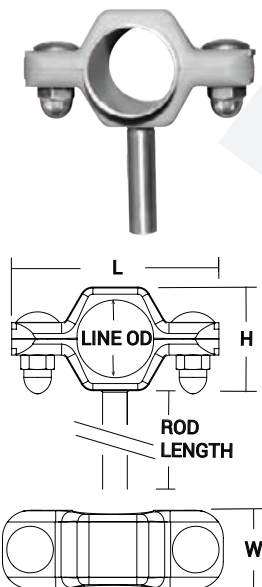

Pipe Size	Line O.D. (in)	H (in)	L (in)	W (in)	Length (in)	O.D. (in)	304 Stainless Steel With Acorn Nut Part #	304 Stainless Steel With Lock Nut Part #
1"	1.32	1.96	4.00	1.42	6	0.38	B24V-PHR6-G100	B24V-PHR6L-G100
1-1/2"	1.90	2.50	4.60	1.42	6	0.38	B24V-PHR6-G150	B24V-PHR6L-G150
2"	2.38	3.00	5.10	1.42	6	0.50	B24V-PHR6-G200	B24V-PHR6L-G200
2-1/2"	2.88	3.50	5.60	1.42	6	0.50	B24V-PHR6-G250	B24V-PHR6L-G250
3"	3.50	4.13	6.33	1.42	6	0.50	B24V-PHR6-G300	B24V-PHR6L-G300
4"	4.50	5.12	7.52	1.42	6	0.63	B24V-PHR6-G400	B24V-PHR6L-G400



## Schedule 5S and 10S Pipe Gaskets

## Nitrile Rubber - 40MPV-U, Black

## Feature

- Color code: red dot

## Approval

- Meets 21CFR 177.2600

Size	Nitrile Rubber Part #
1"	40MPV-U100
1-1/2"	40MPV-U150
2"	40MPV-U200
2-1/2"	40MPV-U250
3"	40MPV-U300
4"	40MPV-U400
6"	40MPV-U600



## PTFE - 40MPV-G, White

## Features

- Color code: no dot
- Not recommended for use with bolted clamps 

## Approvals

- Meets 21CFR 177.1550
- Passed U.S.P. Class VI Cytotoxicity testing

Size	PTFE Part #
1"	40MPV-G100
1-1/2"	40MPV-G150
2"	40MPV-G200
2-1/2"	40MPV-G250
3"	40MPV-G300
4"	40MPV-G400
6"	40MPV-G600



M

PTFE is a material subject to plastic flow. When cycled through heat and then cooled down in process lines, PTFE gaskets will not return to the original configuration, and it will continue to compress as the cycling continues. This plastic flow will allow leakage if clamp torques are not maintained. 

Visit [dixonvalve.com](http://dixonvalve.com) for sizing charts

Schedule 5S and 10S Pipe Gaskets

EPDM - 40MPV-E, Black

Feature

- Color code: 3 green dots

Approvals

- Meets 21CFR 177.2600
- Passed U.S.P. Class VI Cytotoxicity testing



Size	EPDM Part #
1"	40MPV-E100
1-1/2"	40MPV-E150
2"	40MPV-E200
2-1/2"	40MPV-E250
3"	40MPV-E300
4"	40MPV-E400
6"	40MPV-E600

FKM - 40MPV-SFY, Black

Feature

- Color code: 1 white dot, 1 yellow dot

Approvals

- Meets 21CFR 177.2600
- Passed U.S.P. Class VI Cytotoxicity testing

M



Size	FKM Part #
1"	40MPV-SFY100
1-1/2"	40MPV-SFY150
2"	40MPV-SFY200
2-1/2"	40MPV-SFY250
3"	40MPV-SFY300
4"	40MPV-SFY400
6"	40MPV-SFY600

## Sanitary Gaskets

### Types

	Pages
• Clamp .....	674 - 681
• Bevel seat .....	682 - 683
• I-line / Q-line.....	684 - 685
• John Perry.....	686 - 687
• Euro .....	688 - 689
• Clamp gasket sizing chart .....	690 - 692

### Materials

- Nitrile rubber
- Silicone (peroxide cured)
- EPDM
- FKM
- PTFE

### Approvals

- U.S. Pharmacopoeia Class VI Cytotoxicity Criteria
- Title 21 CFR 177.2600 & .1550
- USDA and 3A Sanitary Standards



All elastomeric gaskets require periodic replacement. Gasket life is influenced by the gasket material, product application, temperature, cleaning procedures, etc. After monitoring gasket conditions in a process system, a schedule should be developed for replacement of gaskets.

### Color Coding - Identification of Gasket Materials

Elastomer	Part # Identifier	Color Code	Temperature	
			Farenheit	Celsius
Nitrile rubber	U	1 red dot	-30°F to 200°F	-34°C to 93°C
White nitrile rubber	UW	1 red dot	-30°F to 200°F	-34°C to 93°C
EPDM peroxide cured	E	3 green dots	-30°F to 300°F	-34°C to 149°C
FKM	SFY	1 white dot and 1 yellow dot	-30°F to 400°F	-34°C to 204°C
Silicone platinum cured (white)	XW	1 pink dot	-40°F to 450°F	-40°C to 232°C
Silicone platinum cured (clear)	XC	none	-40°F to 450°F	-40°C to 232°C
PTFE	G	none	-100°F to 500°F	-73°C to 260°C
Metal detectable PTFE	GZ	none	-320°F to 550°F	-195°C to 288°C
Metal detectable nitrile rubber	UZ	2 blue dots and 1 red dot	-30°F to 200°F	-34°C to 93°C
Metal detectable EPDM	EZ	2 blue dots and 3 green dots	-30°F to 300°F	-34°C to 149°C
Metal detectable FKM	SFYZ	2 blue dots and 1 white dot and 1 yellow dot	-30°F to 400°F	-34°C to 204°C
Metal detectable Silicone	XZ	2 blue dots and 1 pink dot	-40°F to 450°F	-40°C to 232°C

### Packaging and Storing Information

The shelf life of rubber gaskets is the maximum period from cure date to the date the product is installed. During the shelf life time, the rubber product is expected to retain its characteristics under the following conditions:

- Stored in original packaging in a clean, dry warehouse
- Not exposed to direct sunlight
- Stored no closer than 6 feet from electric motors
- Temperature between **65°F to 85°F (18°C to 29°C)**

A guideline for shelf life of rubber gaskets manufactured from the following components should have the following shelf life not to exceed:

- |   |          |
|---|----------|
| • Nitrile rubber .....  | 10 years |
| • EPDM.....   | 10 years |
| • FKM .....   | 10 years |
| • Silicone.....   | 5 years  |
| • PTFE .....  | 20 years |
| • Nitrile rubber, EPDM, and Silicone Metal Detectable Gaskets.... | 10 years |

## Clamp Gaskets

### Specifications

- PSI Service Ratings for the sanitary clamps DO NOT APPLY to connections (1" and above) using any PTFE gaskets, due to the potential for cold flow under normal operating conditions. PTFE gaskets, when used with any clamp, are likely to leak at pressures far below the published service ratings. This restriction does not apply to the fractionally sized 1/2" and 3/4" connections, due to their recessed, fully contained design.

### Approval

- Gasket material approved by  (3A), USDA and complies with FDA's 21CFR177.2600 and 1550

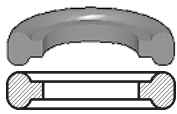

Mini

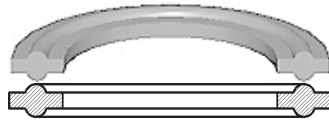

Standard - type 1

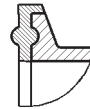

Flanged - type 2

### Clamp Gaskets - Black



Type 1 - Standard  
1" and larger



Type 1 - Standard  
1/2" - 3/4"

#### Feature

- Color code: one red dot

#### Approval

- Meets 21CFR 177.2600

#### Size

1/2"  
3/4"  
1"  
1-1/2"  
2"  
2-1/2"  
3"  
4"  
5"  
6"  
8"

#### Nitrile Rubber Part #

42MP-U50  
42MP-U75  
40MP-U100  
40MP-U150  
40MP-U200  
40MP-U250  
40MP-U300  
40MP-U400  
40MP-U500  
40MP-U600  
40MP-U800

### Clamp Gaskets - White



Type 1 - Standard  
1" and larger



Type 1 - Standard  
1/2" - 3/4"

#### Feature

- Color code: one red dot

#### Approval

- Meets 21CFR 177.2600

#### Size

1/2"  
3/4"  
1"  
1-1/2"  
2"  
2-1/2"  
3"  
4"  
6"

#### Nitrile Rubber Part #

42MP-UW50  
42MP-UW75  
40MP-UW100  
40MP-UW150  
40MP-UW200  
40MP-UW250  
40MP-UW300  
40MP-UW400  
40MP-UW600

### Clamp Gaskets - Black



Type 1 - Standard  
1" and larger



Type 1 - Standard  
1/2" - 3/4"

#### Features

- Color code: three green dots
- Peroxide cured

#### Approvals

- Meets 21CFR 177.2600
- Passed U.S.P. Class VI Cytotoxicity testing

#### Size

1/2"  
3/4"  
1"  
1-1/2"  
2"  
2-1/2"  
3"  
4"  
5"  
6"

#### EPDM Part #

42MP-E50  
42MP-E75  
40MP-E100  
40MP-E150  
40MP-E200  
40MP-E250  
40MP-E300  
40MP-E400  
40MP-E500  
40MP-E600

Visit [dixonvalve.com](http://dixonvalve.com) for sizing charts.

## Clamp Gaskets

### Clamp Gaskets - Black

Size	FKM Part #
1/2"	42MP-SFY50
3/4"	42MP-SFY75
1"	40MP-SFY100
1-1/2"	40MP-SFY150
2"	40MP-SFY200
2-1/2"	40MP-SFY250
3"	40MP-SFY300
4"	40MP-SFY400
6"	40MP-SFY600
8"	40MP-SFY800

#### Features

- Color code: one white dot and one yellow dot
- Peroxide cured

#### Approvals

- Meets 21CFR 177.2600
- Passed U.S.P. Class VI Cytotoxicity testing



Type 1 - Standard  
1/2" - 3/4"



Type 1 - Standard  
1" and larger

### Clamp Gaskets - White

Size	Silicone Part #
1/2"	42MP-XW50
3/4"	42MP-XW75
1"	40MP-XW100
1-1/2"	40MP-XW150
2"	40MP-XW200
2-1/2"	40MP-XW250
3"	40MP-XW300
4"	40MP-XW400
6"	40MP-XW600

#### Features

- Color code: one pink dot
- Peroxide cured

#### Approvals

- Meets 21CFR 177.2600
- Passed U.S.P. Class VI Cytotoxicity testing



Type 1 - Standard  
1/2" - 3/4"



Type 1 - Standard  
1" and larger

### Clamp Gaskets - Clear

Size	Silicone Part #
1/2"	42MP-XC50
3/4"	42MP-XC75
1"	40MP-XC100
1-1/2"	40MP-XC150
2"	40MP-XC200
2-1/2"	40MP-XC250
3"	40MP-XC300
4"	40MP-XC400
5"	40MP-XC500
6"	40MP-XC600
8"	40MP-XC800

#### Features

- Color code: no dot
- Peroxide cured

#### Approval

- Meets 21CFR 177.2600



Type 1 - Standard  
1/2" - 3/4"



Type 1 - Standard  
1" and larger

### Clamp Gaskets - White

Size	PTFE Part #
1/2"	42MP-G50
3/4"	42MP-G75
1"	40MP-G100
1-1/2"	40MP-G150
2"	40MP-G200
2-1/2"	40MP-G250
3"	40MP-G300
4"	40MP-G400
5"	40MP-G500
6"	40MP-G600
8"	40MP-G800
10"	40MP-G1000
12"	40MP-G1200

#### Features

- Color code: no dot
- Not recommended for use with bolted clamps

#### Approvals

- Meets 21CFR 177.1550
- Passed U.S.P. Class VI Cytotoxicity testing



Type 1 - Standard  
1/2" - 3/4"



Type 1 - Standard  
1" and larger



NOTE: PTFE is a material subject to plastic flow. When cycled through heat and then cooled down in process lines, PTFE gaskets will not return to the original configuration, and it will continue to compress as the cycling continues. This plastic flow will allow leakage if clamp torques are not maintained. Visit [dixonvalve.com](http://dixonvalve.com) for sizing charts.

**Metal and X-ray Detectable Clamp Gaskets**



Type 1 - Standard  
1/2" - 3/4"

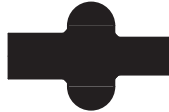

Type 1 - Standard  
1" and larger

**Materials**

- Metal detectable gaskets are impregnated with stainless steel particles, the addition of stainless steel allows a gasket or gasket pieces to be found with metal detection equipment

**Nitrile Rubber - Metal Detectable Clamp Gaskets**

**Feature**

- Color code: two blue dots and one red dot

**Approvals**

- Meets 21CFR 177.2600
- Passed U.S.P Class VI Cytotoxicity testing

Size	Black Part #	Blue Part #	Red Part #
1/2"	42MP-UZ50	42MP-UZ50BL	42MP-UZ50RD
3/4"	42MP-UZ75	42MP-UZ75BL	42MP-UZ75RD
1"	40MP-UZ100	40MP-UZ100BL	40MP-UZ100RD
1-1/2"	40MP-UZ150	40MP-UZ150BL	40MP-UZ150RD
2"	40MP-UZ200	40MP-UZ200BL	40MP-UZ200RD
2-1/2"	40MP-UZ250	40MP-UZ250BL	40MP-UZ250RD
3"	40MP-UZ300	40MP-UZ300BL	40MP-UZ300RD
4"	40MP-UZ400	40MP-UZ400BL	40MP-UZ400RD
6"	40MP-UZ600	40MP-UZ600BL	40MP-UZ600RD
8"	40MP-UZ800	40MP-UZ800BL	40MP-UZ800RD
10"	40MP-UZ1000	40MP-UZ1000BL	40MP-UZ1000RD

**EPDM - Metal Detectable Clamp Gaskets**

**Feature**

- Color code: two blue dots and three green dots

**Approvals**

- Meets 21CFR 177.2600
- Passed U.S.P Class VI Cytotoxicity testing

Size	Black Part #	Blue Part #	Red Part #
1/2"	42MP-E50	42MP-E50BL	--
3/4"	42MP-E75	42MP-E75BL	--
1"	40MP-E100	40MP-E100BL	40MP-E100RD
1-1/2"	40MP-E150	40MP-E150BL	40MP-E150RD
2"	40MP-E200	40MP-E200BL	40MP-E200RD
2-1/2"	40MP-E250	40MP-E250BL	40MP-E250RD
3"	40MP-E300	40MP-E300BL	40MP-E300RD
4"	40MP-E400	40MP-E400BL	40MP-E400RD
6"	40MP-E600	40MP-E600BL	40MP-E600RD
8"	40MP-E800	40MP-E800BL	40MP-E800RD
10"	40MP-E1000	40MP-E1000BL	40MP-E1000RD

**FKM - Metal Detectable Clamp Gaskets**

**Feature**

- Color code: two blue dots, one white dot, and one yellow dot

**Approvals**

- Meets 21CFR 177.2600
- Passed U.S.P Class VI Cytotoxicity testing

Size	Black Part #	Blue Part #	Red Part #
1/2"	42MP-SFY50	42MP-SFY50BL	--
3/4"	42MP-SFY75	42MP-SFY75BL	--
1"	40MP-SFY100	40MP-SFY100BL	40MP-SFY100RD
1-1/2"	40MP-SFY150	40MP-SFY150BL	40MP-SFY150RD
2"	40MP-SFY200	40MP-SFY200BL	40MP-SFY200RD
2-1/2"	40MP-SFY250	40MP-SFY250BL	40MP-SFY250RD
3"	40MP-SFY300	40MP-SFY300BL	40MP-SFY300RD
4"	40MP-SFY400	40MP-SFY400BL	40MP-SFY400RD
6"	40MP-SFY600	40MP-SFY600BL	40MP-SFY600RD

**Silicone - Metal Detectable Clamp Gaskets**

**Feature**

- Color code: two blue dots and one pink dot

**Approvals**

- Meets 21CFR 177.2600
- Passed U.S.P Class VI Cytotoxicity testing

Size	Blue Part #	Red Part #
1/2"	42MP-XZ50BL	42MP-XZ50RD
3/4"	42MP-XZ75BL	42MP-XZ75RD
1"	40MP-XZ100BL	40MP-XZ100RD
1-1/2"	40MP-XZ150BL	40MP-XZ150RD
2"	40MP-XZ200BL	40MP-XZ200RD
2-1/2"	40MP-XZ250BL	40MP-XZ250RD
3"	40MP-XZ300BL	40MP-XZ300RD
4"	40MP-XZ400BL	40MP-XZ400RD
6"	40MP-XZ600BL	40MP-XZ800RD
8"	40MP-XZ800BL	40MP-XZ1000RD

Visit [dixonvalve.com](http://dixonvalve.com) for sizing charts.

## Flanged Clamp Gaskets

### Flanged Clamp Gaskets - Black

Size	Nitrile Rubber Part #
1"	40MPF-U100
1-1/2"	40MPF-U150
2"	40MPF-U200
2-1/2"	40MPF-U250
3"	40MPF-U300
4"	40MPF-U400
6"	40MPF-U600
8"	40MPF-U800
10"	40MPF-U1000
12"	40MPF-U1200

#### Feature

- Color code: one red dot

#### Approval

- Meets 21CFR 177.2600



Type 2 - Flanged  
1" and larger

### Flanged Clamp Gaskets - White

Size	Nitrile Rubber Part #
1"	40MPF-UW100
1-1/2"	40MPF-UW150
2"	40MPF-UW200
2-1/2"	40MPF-UW250
3"	40MPF-UW300
4"	40MPF-UW400
6"	40MPF-UW600
8"	40MPF-UW800
10"	40MPF-UW1000
12"	40MPF-UW1200

#### Feature

- Color code: one red dot

#### Approval

- Meets 21CFR 177.2600



Type 2 - Flanged  
1" and larger

### Flanged Clamp Gaskets - Black

Size	EPDM Part #
1"	40MPF-E100
1-1/2"	40MPF-E150
2"	40MPF-E200
2-1/2"	40MPF-E250
3"	40MPF-E300
4"	40MPF-E400
6"	40MPF-E600
8"	40MPF-E800
10"	40MPF-E1000
12"	40MPF-E1200

#### Features

- Color code: three green dots
- Peroxide cured

#### Approvals

- Meets 21CFR 177.2600
- Passed U.S.P. Class VI Cytotoxicity testing



Type 2 - Flanged  
1" and larger

Visit [dixonvalve.com](http://dixonvalve.com) for sizing charts.

## Clamp Flanged Gaskets

### Flanged Clamp Gaskets - Black



Type 2 - Flanged  
1" and larger

#### Features

- Color code: one white dot, one yellow dot
- Peroxide cured
- Not recommended for use with bolted clamps

#### Approvals

- Meets 21CFR 177.2600
- Passed U.S.P. Class VI Cytotoxicity testing

Size	FKM Part #
1"	40MPF-SFY100
1-1/2"	40MPF-SFY150
2"	40MPF-SFY200
2-1/2"	40MPF-SFY250
3"	40MPF-SFY300
4"	40MPF-SFY400
6"	40MPF-SFY600
8"	40MPF-SFY800
10"	40MPF-SFY1000
12"	40MPF-SFY1200

### Flanged Clamp Gaskets - White

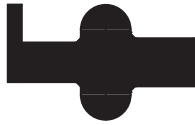

Type 2 - Flanged  
1" and larger

#### Features

- Color code: one pink dot
- Peroxide cured
- Not recommended for use with bolted clamps

#### Approvals

- Meets 21CFR 177.2600
- Passed U.S.P. Class VI Cytotoxicity testing

Size	Silicone Part #
1"	40MPF-XW100
1-1/2"	40MPF-XW150
2"	40MPF-XW200
2-1/2"	40MPF-XW250
3"	40MPF-XW300
4"	40MPF-XW400
6"	40MPF-XW600
8"	40MPF-XW800
10"	40MPF-XW1000
12"	40MPF-XW1200

### Flanged Clamp Gaskets - Clear

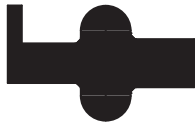

Type 2 - Flanged  
1" and larger

#### Features

- Color code: no dot
- Peroxide cured
- Not recommended for use with bolted clamps

#### Approvals

- Meets 21CFR 177.2600
- Passed U.S.P. Class VI Cytotoxicity testing

Size	Silicone Part #
1"	40MPF-XC100
1-1/2"	40MPF-XC150
2"	40MPF-XC200
2-1/2"	40MPF-XC250
3"	40MPF-XC300
4"	40MPF-XC400
6"	40MPF-XC600
8"	40MPF-XC800
10"	40MPF-XC1000

Visit [dixonvalve.com](http://dixonvalve.com) for sizing charts



## Clamp Mesh Screened Gaskets

### Mesh Screen Clamp Gasket, 316

Size	Nitrile Rubber Part #
1"	40MPS-U100
1-1/2"	40MPS-U150
2"	40MPS-U200
2-1/2"	40MPS-U250
3"	40MPS-U300
4"	40MPS-U400

#### Feature

- Color code: one red dot

#### Approval

- Meets 21CFR 177.2600

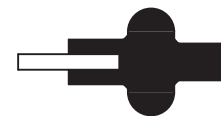

Type 3 - Mesh

### Mesh Screen Clamp Gaskets, 316

Size	EPDM Part #
1"	40MPS-E100
1-1/2"	40MPS-E150
2"	40MPS-E200
2-1/2"	40MPS-E250
3"	40MPS-E300
4"	40MPS-E400

#### Feature

- Color code: three green dot

#### Approval

- Meets 21CFR 177.2600

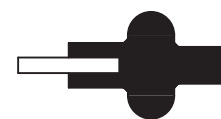

Type 3 - Mesh

### Mesh Screen Clamp Gaskets, 316

Size	FKM Part #
1"	40MPS-SFY100
1-1/2"	40MPS-SFY150
2"	40MPS-SFY200
2-1/2"	40MPS-SFY250
3"	40MPS-SFY300
4"	40MPS-SFY400

#### Feature

- Color code: one white dot

#### Approval

- Meets 21CFR 177.2600

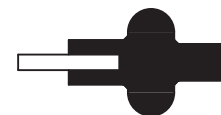

Type 3 - Mesh

NOTE: For other sizes and configurations, contact Dixon Sanitary at 800.789.1718

Visit [dixonvalve.com](http://dixonvalve.com) for sizing charts

### Clamp Perforated Gaskets

#### Perforated Clamp Gaskets - .033" holes

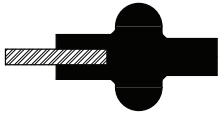

Type 3 - Perforated

**Feature**

- Color code: one red dot

**Material**

- Perforated metal disc 316 stainless steel sheet

**Approval**

- Meets 21CFR 177.2600

Size	Nitrile Rubber Part #
1"	40MP-UP100
1-1/2"	40MP-UP150
2"	40MP-UP200
2-1/2"	40MP-UP250
3"	40MP-UP300
4"	40MP-UP400

### Clamp Orifice Gaskets

#### Orifice Clamp Gaskets, .125" hole

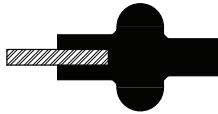

Type 3

**Feature**

- Color code: one red dot

**Material**

- 316 stainless steel sheet

**Approval**

- Meets 21CFR 177.2600

Size	Nitrile Rubber Part #
1"	A80MP-U100
1-1/2"	A80MP-U150
2"	A80MP-U200
2-1/2"	A80MP-U250
3"	A80MP-U300
4"	A80MP-U400

#### Orifice Clamp Gaskets, .125" hole

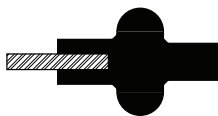

Type 3

**Feature**

- Color code: one white dot

**Material**

- 316 stainless steel sheet

**Approval**

- Meets 21CFR 177.2600

Size	FKM Part #
1"	A80MP-SFY100
1-1/2"	A80MP-SFY150
2"	A80MP-SFY200
2-1/2"	A80MP-SFY250
3"	A80MP-SFY300
4"	A80MP-SFY400

NOTE: For other sizes and configurations, contact Dixon Sanitary at 800.789.1718

M

## Clamp Envelope Gaskets

### Envelope Clamp Gaskets with EPDM Filler

Size	PTFE Part #
1/2"	42MP-GRE50
3/4"	42MP-GRE75
1"	40MP-GRE100
1-1/2"	40MP-GRE150
2"	40MP-GRE200
2-1/2"	40MP-GRE250
3"	40MP-GRE300
4"	40MP-GRE400
6"	40MP-GRE600
8"	40MP-GRE800

#### Features

- Color code: usually not marked
- Peroxide cured EPDM

#### Approvals

- Meets 21CFR 177.1550
- PTFE Passed U.S.P. Class VI Cytotoxicity testing

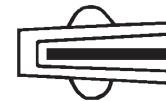

### Envelope Clamp Gaskets with FKM Filler

Size	PTFE Part #
1/2"	42MP-GR50
3/4"	42MP-GR75
1"	40MP-GR100
1-1/2"	40MP-GR150
2"	40MP-GR200
2-1/2"	40MP-GR250
3"	40MP-GR300
4"	40MP-GR400
6"	40MP-GR600
8"	40MP-GR800

#### Features

- Color code: usually not marked
- Peroxide cured FKM

#### Approvals

- Meets 21CFR 177.1550
- PTFE Passed U.S.P. Class VI Cytotoxicity testing



NOTE: PTFE is a material subject to plastic flow. When cycled through heat and then cooled down in process lines, PTFE gaskets will not return to the original configuration, and it will continue to compress as the cycling continues. This plastic flow will allow leakage if clamp torques are not maintained.



**Bevel Seat Gaskets**

**Bevel Seat Gaskets - Black**

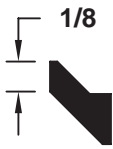

**Feature**

- Color code: one red dot

**Approval**

- Meets 21CFR 177.2600

Size	Nitrile Rubber Part #
1"	40BS-O100
1-1/2"	40BS-O150
2"	40BS-O200
2-1/2"	40BS-O250
3"	40BS-O300
4"	40BS-O400

**Flat Bevel Seat Gaskets - Black**



**Feature**

- Color code: one red dot

**Approval**

- Meets 21CFR 177.2600

Size	Nitrile Rubber Part #
1"	40BS-F100
1-1/2"	40BS-F150
2"	40BS-F200
2-1/2"	40BS-F250
3"	40BS-F300
4"	40BS-F400

**Bevel Seat Gaskets - Black**

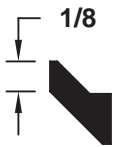

**Features**

- Color code: three green dots
- Peroxide cured

**Approvals**

- Meets 21CFR 177.2600
- Passed U.S.P. Class VI Cytotoxicity testing

Size	EPDM Part #
1"	40BS-E100
1-1/2"	40BS-E150
2"	40BS-E200
2-1/2"	40BS-E250
3"	40BS-E300
4"	40BS-E400

**Bevel Seat Gaskets - Black**

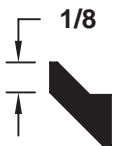

**Features**

- Color code: one white dot and one yellow dot
- Peroxide cured

**Approvals**

- Meets 21CFR 177.2600
- Passed U.S.P. Class VI Cytotoxicity testing

Size	FKM Part #
1"	40BS-Y100
1-1/2"	40BS-Y150
2"	40BS-Y200
2-1/2"	40BS-Y250
3"	40BS-Y300
4"	40BS-Y400

NOTE: PTFE is a material subject to plastic flow. When cycled through heat and then cooled down in process lines, PTFE gaskets will not return to the original configuration and it will continue to compress as the cycling continues. This plastic flow will allow leakage if clamp torques are not maintained.



Visit [dixonvalve.com](http://dixonvalve.com) for sizing charts

## Bevel Seat Gaskets

### Bevel Seat Gaskets - White

Size	Silicone Part #
1"	40BS-X100
1-1/2"	40BS-X150
2"	40BS-X200
2-1/2"	40BS-X250
3"	40BS-X300
4"	40BS-X400

#### Features

- Color code: no dot
- Peroxide cured

#### Approvals

- Meets 21CFR 177.2600
- Passed U.S.P. Class VI Cytotoxicity testing

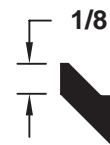

### Bevel Seat Gaskets - White

Size	PTFE Part #
1"	40BS-S100
1-1/2"	40BS-S150
2"	40BS-S200
2-1/2"	40BS-S250
3"	40BS-S300
4"	40BS-S400

#### Feature

- Color code: no dot

#### Approvals

- Meets 21CFR 177.1550
- Passed U.S.P. Class VI Cytotoxicity testing

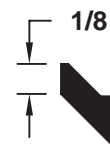

### Bevel Seat Gaskets - White

Size	Heavy PTFE Part #
1"	40BS-H100
1-1/2"	40BS-H150
2"	40BS-H200
2-1/2"	40BS-H250
3"	40BS-H300
4"	40BS-H400

#### Feature

- Color code: no dot

#### Approvals

- Meets 21CFR 177.1550
- Passed U.S.P. Class VI Cytotoxicity testing

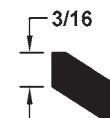

PTFE is a material subject to plastic flow. When cycled through heat and then cooled down in process lines, PTFE gaskets will not return to the original configuration, and it will continue to compress as the cycling continues. This plastic flow will allow leakage if clamp torques are not maintained.



I-Line Gaskets

I-Line Gaskets - Black 3/32"



**Feature**

- Color code: one red dot

**Approval**

- Meets 21CFR 177.2600

Size	Nitrile Rubber Part #
1"	40IH100
1-1/2"	40IH150
2"	40IH200
2-1/2"	40IH250
3"	40IH300
4"	40IH400
6"	40IH600
8"	40IH800

I-Line Gaskets - White 3/32"



**Features**

- Color code: three green dots
- Peroxide cured

**Approvals**

- Meets 21CFR 177.2600
- Passed U.S.P. Class VI Cytotoxicity testing

Size	EPDM Part #
1"	40IE100
1-1/2"	40IE150
2"	40IE200
2-1/2"	40IE250
3"	40IE300
4"	40IE400
6"	40IE600
8"	40IE800

I-Line Gaskets - White 1/16"



**Features**

- Color code: three green dots
- Peroxide cured

**Approvals**

- Meets 21CFR 177.2600
- Passed U.S.P. Class VI Cytotoxicity testing

Size	EPDM Part #
1-1/2"	40IE15016
2"	40IE20016
2-1/2"	40IE25016
3"	40IE30016
4"	40IE40016
6"	40IE60016
8"	40IE80016

I-Line Gaskets - 1/16"



**Features**

- Color code: one white dot and one yellow dot
- Peroxide cured

**Approvals**

- Meets 21CFR 177.1550
- Passed U.S.P. Class VI Cytotoxicity testing

Size	FKM Part #
1"	40IV10016
1-1/2"	40IV15016
2"	40IV20016
2-1/2"	40IV25016
3"	40IV30016
4"	40IV40016
6"	40IV60016
8"	40IV80016

I-Line Gaskets - 3/32"



**Features**

- Color code: one white dot and one yellow dot
- Peroxide cured

**Approvals**

- Meets 21CFR 177.1550
- Passed U.S.P. Class VI Cytotoxicity testing

Size	FKM Part #
1"	40IV100
1-1/2"	40IV150
2"	40IV200
2-1/2"	40IV250
3"	40IV300
4"	40IV400
6"	40IV600
8"	40IV800

M

## I-Line Gaskets

### I-Line Gaskets - 1/16"

Size	PTFE Part #
1"	40IT100
1-1/2"	40IT150
2"	40IT200
2-1/2"	40IT250
3"	40IT300
4"	40IT400
6"	40IT600
8"	40IT800

#### Feature

- Color code: no dot

#### Approvals

- Meets 21CFR 177.1550
- Passed U.S.P. Class VI Cytotoxicity testing



PTFE is a material subject to plastic flow. When cycled through heat and then cooled down in process lines, PTFE gaskets will not return to the original configuration and it will continue to compress as the cycling continues. This plastic flow will allow leakage if clamp torques are not maintained.



## Q-Line Gaskets

### Q-Line Gaskets - Black

Size	Nitrile Rubber Part #
1"	40QH100
1-1/2"	40QH150
2"	40QH200
2-1/2"	40QH250
3"	40QH300
4"	40QH400

#### Feature

- Color code: one red dot

#### Approval

- Meets 21CFR 177.2600

**M**

### Q-Line Gaskets - White

Size	PTFE Part #
1"	40QT100
1-1/2"	40QT150
2"	40QT200
2-1/2"	40QT250
3"	40QT300
4"	40QT400

#### Feature

- Color code: no dot

#### Approvals

- Meets 21CFR 177.1550
- Passed U.S.P. Class VI Cytotoxicity testing



PTFE is a material subject to plastic flow. When cycled through heat and then cooled down in process lines, PTFE gaskets will not return to the original configuration, and it will continue to compress as the cycling continues. This plastic flow will allow leakage if clamp torques are not maintained.



**John Perry Gaskets**

**John Perry Gaskets**

**Feature**

- Color code: one red dot

**Approval**

- Meets 21CFR 177.2600

Size	Nitrile Rubber 80 Duro Part #
1"	40JP-U100
1-1/2"	40JP-U150
2"	40JP-U200
2-1/2"	40JP-U250
3"	40JP-U300
4"	40JP-U400

**John Perry Gaskets**

**Features**

- Color code: three green dots
- Peroxide cured

**Approvals**

- Meets 21CFR 177.2600
- Passed U.S.P. Class VI Cytotoxicity testing

Size	EPDM Part #
1"	40JP-E100
1-1/2"	40JP-E150
2"	40JP-E200
2-1/2"	40JP-E250
3"	40JP-E300
4"	40JP-E400

M



## John Perry Gaskets

### John Perry Gaskets

#### Features

- Color code: one white dot and one yellow dot
- Peroxide cured

#### Approvals

- Meets 21CFR 177.2600
- Passed U.S.P. Class VI Cytotoxicity testing

Size	FKM Part #
1"	40JP-SFY100
1-1/2"	40JP-SFY150
2"	40JP-SFY200
2-1/2"	40JP-SFY250
3"	40JP-SFY300
4"	40JP-SFY400



### John Perry Gaskets

#### Feature

- Color code: no dot

#### Approvals

- Meets 21CFR 177.1550
- Passed U.S.P. Class VI Cytotoxicity testing

Size	Virgin PTFE Part #
1"	40JP-G100
1-1/2"	40JP-G150
2"	40JP-G200
2-1/2"	40JP-G250
3"	40JP-G300
4"	40JP-G400

**M**

PTFE is a material subject to plastic flow. When cycled through heat and then cooled down in process lines, PTFE gaskets will not return to the original configuration and it will continue to compress as the cycling continues. This plastic flow will allow leakage if clamp torques are not maintained.



European Fittings - Gaskets

DIN Euro Gaskets - Black

Feature

- Color code: one red dot

Specification

- DIN 11851

Approval

- Meets 21CFR 177.2600

Nominal Size	I.D. (mm)	O.D. (mm)	Nitrile Rubber Part #
1"	29.97	39.88	40MP-U100DIN
1-1/2"	41.91	52.07	40MP-U150DIN
2"	54.10	64.01	40MP-U200DIN
2-1/2"	71.12	81.03	40MP-U250DIN
3"	85.09	95.00	40MP-U300DIN
4"	103.89	114.05	40MP-U400DIN

SMS Euro Gaskets - Black

Features

- Color code: one red dot
- L-style

Approval

- Meets 21CFR 177.2600

Nominal Size	I.D. (mm)	O.D. (mm)	Nitrile Rubber Part #
1"	24.89	32.00	40MP-U100SMS
1-1/2"	37.49	48.00	40MP-U150SMS
2"	50.80	61.00	40MP-U200SMS
2-1/2"	63.50	73.40	40MP-U250SMS
3"	75.95	86.10	40MP-U300SMS
4"	103.89	114.00	40MP-U400SMS

RJT Nitrile Rubber Euro Gaskets - Black

Feature

- Color code: one red dot

Approval

- Meets 21CFR 177.2600

Nominal Size	I.D. (mm)	O.D. (mm)	Nitrile Rubber Part #
1"	26.92	6.35	40MP-U100RJT
1-1/2"	39.62	6.35	40MP-U150RJT
2"	52.32	6.35	40MP-U200RJT
2-1/2"	65.08	6.35	40MP-U250RJT
3"	77.72	6.35	40MP-U300RJT
4"	103.12	6.35	40MP-U400RJT

## European Gaskets

### DIN Euro Gaskets - Black

#### Feature

- Color code: three green dots

#### Specification

- DIN 11851

#### Approval

- Meets 21CFR 177.2600

Nominal Size	I.D. (mm)	O.D. (mm)	EPDM Part #
1"	29.97	39.88	40MP-E100DIN
1-1/2"	41.91	52.07	40MP-E150DIN
2"	54.10	64.01	40MP-E200DIN
2-1/2"	71.12	81.03	40MP-E250DIN
3"	85.09	95.00	40MP-E300DIN
4"	103.89	114.05	40MP-E400DIN



### SMS Euro Gaskets - Black

#### Features

- Color code: three green dots
- L-style

#### Approval

- Meets 21CFR 177.2600

Nominal Size	I.D. (mm)	O.D. (mm)	EPDM Part #
1"	24.89	32.00	40MP-E100SMS
1-1/2"	37.49	48.00	40MP-E150SMS
2"	50.80	61.00	40MP-E200SMS
2-1/2"	63.50	73.40	40MP-E250SMS
3"	75.95	86.10	40MP-E300SMS
4"	103.89	114.00	40MP-E400SMS

**M**

### RJT Euro Gaskets - Black

#### Feature

- Color code: three green dots

#### Approval

- Meets 21CFR 177.2600

Nominal Size	I.D. (mm)	O.D. (mm)	EPDM Part #
1"	26.92	6.35	40MP-E100RJTCIP
1-1/2"	39.62	6.35	40MP-E150RJTCIP
2"	52.32	6.35	40MP-E200RJTCIP
2-1/2"	65.08	6.35	40MP-E250RJTCIP
3"	77.72	6.35	40MP-E300RJTCIP
4"	103.12	6.35	40MP-E400RJTCIP



Clamp Fittings and Gasket Sizing Guide

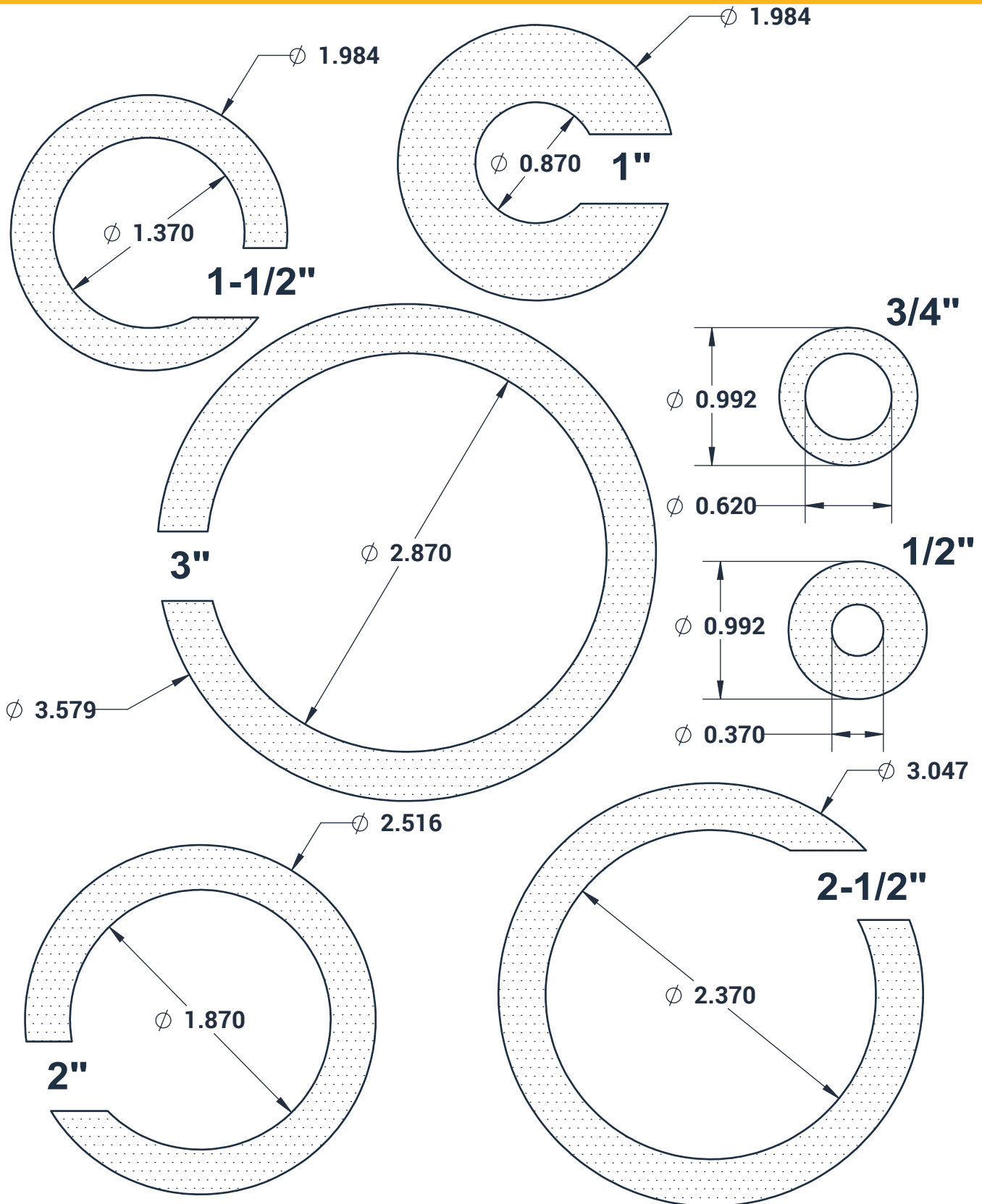

**M**

Sanitary Size	O.D. of Clamp End (in)	I.D. of Fitting (in)
1/2"	0.992	0.370
3/4"	0.992	0.620
1"	1.984	0.870
1-1/2"	1.984	1.370
2"	2.516	1.870
2-1/2"	3.047	2.370

Sanitary Size	O.D. of Clamp End (in)	I.D. of Fitting (in)
3"	3.579	2.870
4"	4.682	3.834
6"	6.562	5.782
8"	8.602	7.782
10"	10.570	9.782
12"	12.570	11.760

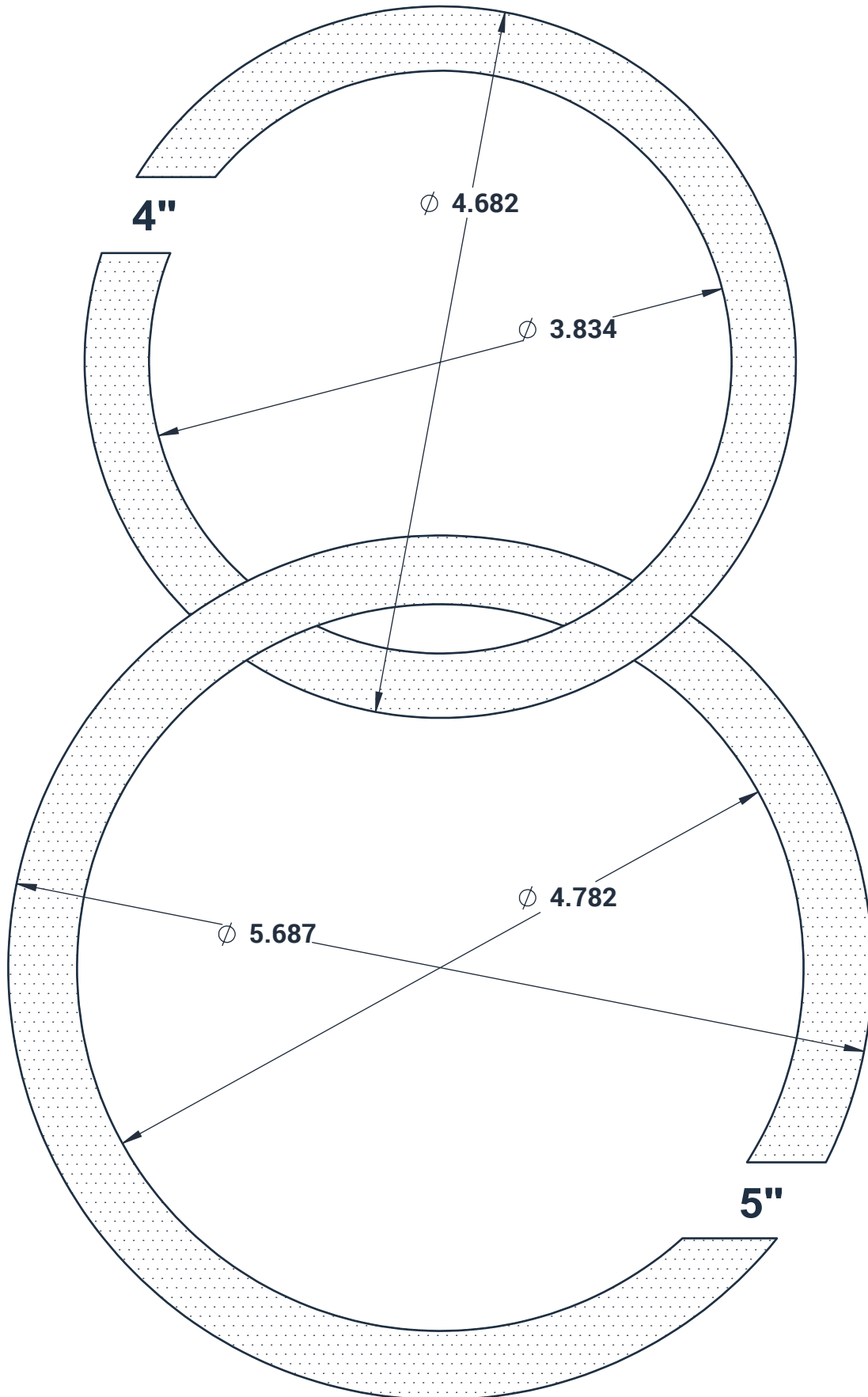

M

Clamp Fittings and Gasket Sizing Guide

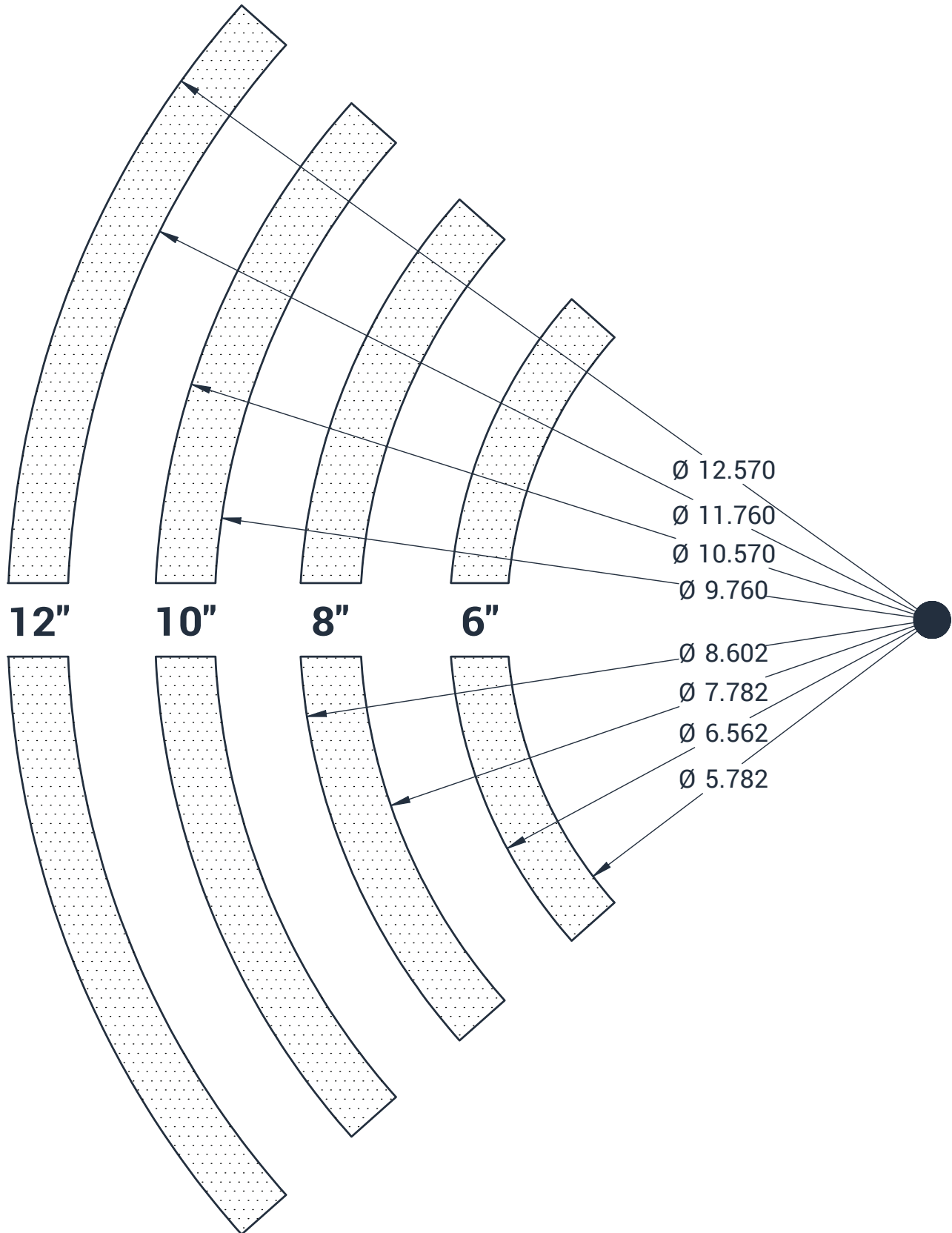

M

### Dixon Sanitary Tubing



**Size**

- 1/2" - 6" O.D. tube

**Materials**

- G = 304L stainless steel
- R = 316L stainless steel
- 3A sanitary finish I.D. and O.D.; Typical 32R<sub>a</sub>
- Unpolished
- BPE finishes:
  - SF1: 20Ra I.D., 32Ra O.D.
  - SF4: 15Ra I.D., 32Ra O.D.

Tube O.D.	Nominal Wall Thickness (inches)	Gage Number	Wt. Pounds per Ft.
1/2"	.065	16	0.31
3/4"	.065	16	0.49
1"	.065	16	0.67
1-1/2"	.065	16	1.02
2"	.065	16	1.36
2-1/2"	.065	16	1.71
3"	.065	16	2.06
4"	.083	14	3.45
6"	.109	12	6.92

- Surcharges change MONTHLY
- Tubing available in 20' lengths only
- Broken box charges apply
- Tubing only ships via truck
- Tubing is NOT returnable
- Call Dixon Sanitary at 800.789.1718 for pricing, full freight allowance, and other sizes available

### Operating Pressures

304L Stainless Steel Tube

Tube O.D.	Nominal Wall Thickness (in)	Pressure (PSI)		
		Working	Yield	Burst
1/2"	.065	4,870	7,800	19,500
3/4"	.065	3,250	5,200	13,000
1"	.065	2,440	3,900	9,800
1-1/2"	.065	1,630	2,600	6,500
2"	.065	1,220	2,000	4,900
2-1/2"	.065	980	1,600	3,900
3"	.065	810	1,300	3,300
4"	.083	780	1,200	3,100
6"	.109	680	1,090	2,720

316L Stainless Steel Tube

Tube O.D.	Nominal Wall Thickness (in)	Pressure (PSI)		
		Working	Yield	Burst
1/2"	.065	3,250	6,500	19,500
3/4"	.065	2,167	4,330	13,000
1"	.065	2,280	3,300	9,100
1-1/2"	.065	1,520	2,200	6,100
2"	.065	1,140	1,600	4,600
2-1/2"	.065	910	1,300	3,600
3"	.065	760	1,100	3,000
4"	.083	730	1,000	2,900
6"	.109	635	900	2,540

The pressures shown in the table above are calculated using Barlow's Formula and the following properties:

- Material: 304L stainless steel
- Yield strength (PSI): 30,000
- Tensile strength (PSI): 75,000

Working Pressure = 1/4 of Burst Pressure, these calculate from -20°F to 100°F (-29°C to 38°C).

The pressures shown in the table above are calculated using Barlow's Formula and the following properties:

- Material: 316L stainless steel
- Yield strength (PSI): 25,000
- Tensile strength (PSI): 70,000

Working Pressure = 1/4 of Burst Pressure, these calculate from -20°F to 100°F (-29°C to 38°C).



Pipe size and tube O.D. size materials are not interchangeable



## ASTM-A270 Polished I.D. and O.D. Tubing

### 3A Food Grade

**Feature**

- ASTM-A270-02 welded austenitic stainless steel sanitary tubing



Size	Nominal Wall Thickness (in)	Box Quantity/ Sticks	Tubing Type	304L Stainless Steel Part #	316L Stainless Steel Part #
1/2"	0.065	100' / 5	Seamless	A270-R50P	--
3/4"	0.065	100' / 5	Seamless	A270-R75P	--
1"	0.065	280' / 14	Laser Weld	A270-R100P	A270-G100P
1-1/2"	0.065	340' / 17	Laser Weld	A270-R150P	A270-G150P
2"	0.065	340' / 17	Laser Weld	A270-R200P	A270-G200P
2-1/2"	0.065	220' / 11	Laser Weld	A270-R250P	A270-G250P
3"	0.065	220' / 11	Laser Weld	A270-R300P	A270-G300P
4"	0.065	100' / 5	Laser Weld	--	A270.065-G400P
4"	0.083	100' / 5	Laser Weld	A270.083-R400P	A270.083-G400P
5"	0.083	40' / 2	Passivated Laser Weld	--	A270.083-G500P
6"	0.083	40' / 2	Passivated Laser Weld	--	A270.083-G600P
6"	0.109	40' / 2	Passivated Laser Weld	A270.109-R600P	A270.109-G600P
8"	0.109	40' / 2	Passivated Laser Weld	A270-R800P	A270-G800P

## ASTM-A269 Unpolished I.D. and O.D. Tubing

### General Service - for Winery / Cannery Applications

**Feature**

- ASTM-A269-02 welded austenitic stainless steel sanitary tubing for general service



Size	Nominal Wall Thickness (in)	Box Quantity/ Sticks	Tubing Type	304L Stainless Steel Part #	316L Stainless Steel Part #
1"	0.065	280' / 14	Laser Weld	A269-R100U	A269-G100U
1-1/2"	0.065	340' / 17	Laser Weld	A269-R150U	A269-G150U
2"	0.065	340' / 17	Laser Weld	A269-R200U	A269-G200U
2-1/2"	0.065	220' / 11	Laser Weld	A269-R250U	A269-G250U
3"	0.065	220' / 11	Laser Weld	A269-R300U	A269-G300U
4"	0.065	100' / 5	Laser Weld	--	A269.065-G400U
4"	0.083	100' / 5	Laser Weld	A269.083-R400U	A269.083-G400U
5"	0.083	40' / 2	Passivated Laser Weld	--	A269.083-G500U
6"	0.083	40' / 2	Passivated Laser Weld	--	A269.083-G600U
6"	0.109	40' / 2	Passivated Laser Weld	A269.109-R600U	A269.109-G600U
8"	0.109	40' / 2	Passivated Laser Weld	A269-R800U	A269-G800U

M



## ASTM-A270 BPE Polished I.D. and O.D. Polished Tubing

316L BPE-Pharmaceutical Grade (Stenciled According to BPE)

### Feature

- ASTM-A270-S2 laser welded tubing

Size	Nominal Wall Thickness (in)	Box Quantity/ Sticks	Tubing Type	Surface Finish	
				SF1	SF4
1/2"	0.065	100' / 5	Seamless	A270-R050PL	A270-050PM
3/4"	0.065	100' / 5	Seamless	A270-R075PL	A270-075PM
1"	0.065	280' / 14	Laser Weld	A270-R100PL	A270-100PM
1-1/2"	0.065	340' / 17	Laser Weld	A270-R150PL	A270-150PM
2"	0.065	340' / 17	Laser Weld	A270-R200PL	A270-200PM
2-1/2"	0.065	220' / 11	Laser Weld	A270-R250PL	A270-250PM
3"	0.065	220' / 11	Laser Weld	A270-R300PL	A270-300PM
4"	0.083	100' / 5	Laser Weld	A270-R400PL	A270-400PM
6"	0.109	40' / 2	Passivated Laser Weld	A270-R600PL	A270-600PM



M

PM Finish - Mechanical Polish - 20Ra max I.D., 32Ra max O.D.  
 PL Finish- Electropolish - 15Ra max I.D., 32Ra max O.D.

## Tube Hex Hangers

### Hex Hanger with Rubber Grommets - B24RG

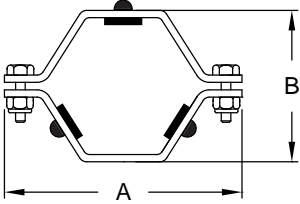

**Specifications**

- All hex and round style hangers can be equipped with the following coupler options:
  - 3/8" NPT
  - all thread: 3/8"-16 or 1/2"-13
- Rubber grommets maximum temperature: **230°F (110°C)**

Tube O.D.	A (in)	B (in)	304 Stainless Steel Part #
1/2"	3.38	2.13	B24RG-G50
3/4"	3.38	2.13	B24RG-G75
1"	3.38	2.13	B24RG-G100
1-1/2"	3.75	2.13	B24RG-G150
2"	4.44	2.63	B24RG-G200
2-1/2"	4.94	3.13	B24RG-G250
3"	5.56	3.63	B24RG-G300
4"	6.63	4.50	B24RG-G400
5"	8.13	5.63	B24RG-G500
6"	9.19	6.63	B24RG-G600
8"	11.38	8.75	B24RG-G800
10"	14.50	10.50	B24RG-G1000
12"	16.63	12.63	B24RG-G1200

### Hex Hanger with FKM Grommets - B24RGSFY

M

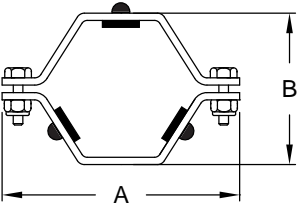

**Features**

- All hex and round style hangers can be equipped with the following coupler options:
  - 3/8" NPT
  - all thread: 3/8"-16 or 1/2"-13

**Specification**

- FKM grommets maximum temperature: **392°F (200°C)**

Tube O.D.	A	B	304 Stainless Steel Part #
1/2"	3.38	2.13	B24RGSFY-G50
3/4"	3.38	2.13	B24RGSFY-G75
1"	3.38	2.13	B24RGSFY-G100
1-1/2"	3.75	2.13	B24RGSFY-G150
2"	4.44	2.63	B24RGSFY-G200
2-1/2"	4.94	3.13	B24RGSFY-G250
3"	5.56	3.63	B24RGSFY-G300
4"	6.63	4.50	B24RGSFY-G400
6"	9.19	6.63	B24RGSFY-G600
8"	11.38	8.75	B24RGSFY-G800
10"	14.50	10.50	B24RGSFY-G1000
12"	16.63	12.63	B24RGSFY-G1200

## Tube Hex Hangers

### Hex Hanger with Rubber Grommets and All Thread Coupler - B24RGC16

#### Features

- Coupler is all thread 3/8"-16
- Optional: 1/2"-13 all thread

#### Specification

- Rubber grommets maximum temperature: 230°F (110°C)

#### 3/8" NPT

Tube O.D.	A (in)	B (in)	C (in)	304 Stainless Steel Part #
1/2" - 3/4"	3.43	1.45	0.75	B24RGC-G75
1"	3.43	1.45	0.75	B24RGC-G100
1-1/2"	4.00	2.13	0.75	B24RGC-G150
2"	4.50	2.50	0.75	B24RGC-G200
2-1/2"	4.75	1.13	0.75	B24RGC-G250
3"	5.50	3.75	0.75	B24RGC-G300
4"	6.75	4.75	0.75	B24RGC-G400
6"	9.25	6.63	0.75	B24RGC-G600
8"	11.50	8.63	0.75	B24RGC-G800

#### 1/2"-13

Tube O.D.	A (in)	B (in)	C (in)	304 Stainless Steel Part #
1/2" - 3/4"	3.43	1.45	0.75	B24RGC13-G75
1"	3.43	1.45	0.75	B24RGC13-G100
1-1/2"	4.00	2.13	0.75	B24RGC13-G150
2"	4.50	2.50	0.75	B24RGC13-G200
2-1/2"	4.75	1.13	0.75	B24RGC13-G250
3"	5.50	3.75	0.75	B24RGC13-G300
4"	6.75	4.75	0.75	B24RGC13-G400
6"	9.25	6.63	0.75	B24RGC13-G600
8"	11.50	8.63	0.75	B24RGC13-G800

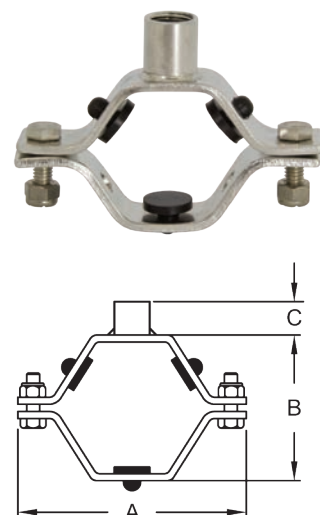
**M**

## Tube Hex Hangers

### Nuts and Bolts - 13NHN



#### Features

- All sizes hex hangers with grommets and round hangers 1" to 4" use 13NHN-G100-600 fastener sets
- 1/2" and 3/4" round and sleeved hangers use 13NHN-G75 fastener sets
- (2) nuts and bolts supplied to a set

Size	Description	304 Stainless Steel Part #
1/2" - 3/4"	1/4"-20 x 3/4" bolt with nylock nut	13NHN-G75
1" - 12"	5/16"-18 x 1" bolt with nylock nut	13NHN-G100-600

### Grommets - 13RG

#### Specifications

- Rubber grommets maximum temperature: **230°F (110°C)**
- High-temp rubber grommets maximum temperature: **392°F (200°C)**

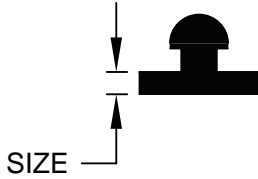

Size	Rubber Part #	High-Temp Rubber Part #
1/8" <sup>1</sup>	13RG18	13RGV18
1/4"	13RG14	13RGV14
1/2"	13RG12	13RGV12
3/8" <sup>2</sup>	13RG3/8	13RGV38
5/8"	13RG58	13RGV58

**M**

<sup>1</sup> For 1" hangers and larger

<sup>2</sup> For 1/2" and 3/4" hangers

## Tube Hex Hangers

### Hex Hanger with Polypropylene Sleeve - B24PS

#### Specification

- Polypropylene sleeve maximum temperature: 230°F (110°C)

Tube O.D.	A (in)	B (in)	304 Stainless Steel Part #
1/2"	2.80	1.15	B24PS-G50
3/4"	2.80	1.15	B24PS-G75
1"	3.43	1.45	B24PS-G100
1-1/2"	4.00	2.13	B24PS-G150
2"	4.50	2.50	B24PS-G200
2-1/2"	4.95	3.13	B24PS-G250
3"	5.50	3.75	B24PS-G300
4"	6.95	4.75	B24PS-G400
5"	8.06	5.63	B24PS-G500
6"	9.25	6.63	B24PS-G600
8"	11.50	8.63	B24PS-G800
10"	14.50	10.50	B24PS-G1000
12"	16.63	13.00	B24PS-G1200

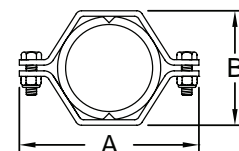

NOTE: Metal detectable options available upon request.

### Hex Hanger with High Temperature Polysulfone Sleeve - B24HS

#### Specification

- High temperature sleeve maximum temperature: 325°F (163°C)

Tube O.D.	A (in)	B (in)	304 Stainless Steel Part #
1/2"	2.38	1.06	B24HS-G50
3/4"	2.63	1.19	B24HS-G75
1"	2.69	1.56	B24HS-G100
1-1/2"	3.63	2.13	B24HS-G150
2"	4.63	2.63	B24HS-G200
2-1/2"	4.81	3.13	B24HS-G250
3"	5.38	3.63	B24HS-G300
4"	6.63	4.63	B24HS-G400
6"	9.00	6.63	B24HS-G600

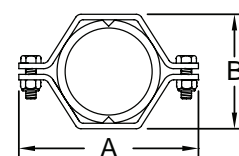

NOTE: Sleeve must be removed before welding.

**M**

Tube Hex Hangers

Sleeves - 13PS

Specifications

- Polypropylene sleeve maximum temperature: 230°F (110°C)
- High-temperature sleeve maximum temperature: 325°F (163°C)



Polypropylene



High Temperature

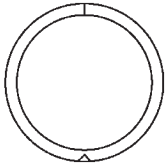

Size	Polypropylene Part #	High-Temperature Part #
1/2"	13PS-50	13HS-50
3/4"	13PS-75	13HS-75
1"	13PS-100	13HS-100
1-1/2"	13PS-150	13HS-150
2"	13PS-200	13HS-200
2-1/2"	13PS-250	13HS-250
3"	13PS-300	13HS-300
4"	13PS-400	13HS-400
5"	13PS-500	---
6"	13PS-600	13HS-600
8"	13PS-800	---

NOTE: Metal detectable options available upon request.

Round Hanger with Nitrile Inserts - B24RPH

Features

- All hex and round style hangers can be equipped with the following coupler options: 3/8" NPT or all thread; 3/8"-16 or 1/2"-13 available upon request



Specification

- Nitrile inserts maximum temperature: 230°F (110°C)

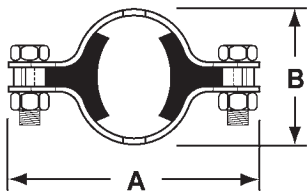

Tube O.D.	A (in)	B (in)	304 Stainless Steel Part #
1/2"	2.75	1.13	B24RPH-G50
3/4"	2.75	1.13	B24RPH-G75
1"	3.31	1.50	B24RPH-G100
1-1/2"	3.81	2.00	B24RPH-G150
2"	4.25	2.56	B24RPH-G200
2-1/2"	5.00	3.00	B24RPH-G250
3"	5.50	3.56	B24RPH-G300
4"	6.50	4.69	B24RPH-G400

M

## Tube Block Hangers

### Applications

- Clean rooms and mechanical areas; not limited to: biotech, pharmaceutical, food processing
- Low flow and low pressure systems with moderate vibration: WFI, SIP, CIP, process, utility, and instrument lines

### Sizes

- Support range: 1/2" - 4"; optional 6" - contact Dixon Sanitary at 800.789.1718

### Materials

- ZERO PUDDLE silicone rubber insert are available with FDA and UL ratings
- Hardware: 304 standard option and 316 stainless steel available upon request

### Features

- Insulation envelope: reduced O.D. allows hanger to be buried under the insulation jacket.
- ZERO PUDDLE silicone inserts raised geometry facilitates drainage of liquids on vertical/riser lines
- There are no exposed threads or openings in hardware plates

### Specification

- Intermittent temperatures from -40°F to 320°F (-40°C to 160°C)
- Continuous temperatures from -20° to 285°F (-29°C to 140°C)

### Approvals

- All plates polished; bolts are cleaned and nuts are lubricated with FDA approved product
- Hanger threads match MSS SP-69 rod O.D. requirements

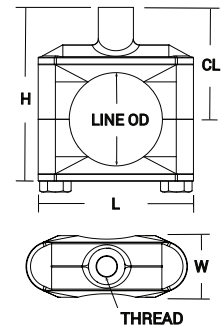

### Hang Plate Block Hangers - B24-HP

Tube O.D.	Line O.D.(in)	H (in)	L (in)	W (in)	CL (in)	Thread	304 Stainless Steel Part #
1/2"	.50	2.29	1.93	.75	.63	3/8"-16	B24-HP-G050
3/4"	.75	2.29	1.93	.75	.63	3/8"-16	B24-HP-G075
1"	1.00	2.29	1.96	.75	.63	3/8"-16	B24-HP-G100
1-1/2"	1.50	2.79	2.49	.75	.97	3/8"-16	B24-HP-G150
2"	2.00	3.29	2.99	.88	1.25	1/2"-13	B24-HP-G200
2-1/2"	2.50	4.43	3.36	.88	1.47	1/2"-13	B24-HP-G250
3"	3.00	5.18	3.99	.88	1.81	1/2"-13	B24-HP-G300
4"	4.00	6.24	5.10	1.00	2.28	5/8"-11	B24-HP-G400

### Weld Plate Block Hangers - B24-WP

Tube O.D.	Line O.D. (in)	H (in)	L (in)	W (in)	CL (in)	304 Stainless Steel Part #
1/2"	.50	1.73	1.93	.75	.79	B24-WP-G050
3/4"	.75	1.73	1.93	.75	.79	B24-WP-G075
1"	1.00	1.73	1.96	.75	.79	B24-WP-G100
1-1/2"	1.50	2.23	2.49	.75	1.03	B24-WP-G150
2"	2.00	2.75	2.99	.88	1.31	B24-WP-G200
2-1/2"	2.50	3.25	3.36	.88	1.55	B24-WP-G250
3"	3.00	3.97	3.99	.88	1.94	B24-WP-G300
4"	4.00	4.87	5.10	1.00	2.39	B24-WP-G400

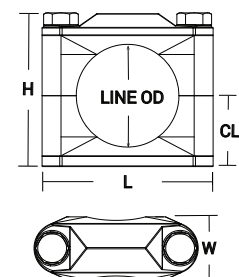

### Tube Uni-Hinge Block Hangers

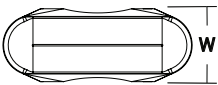
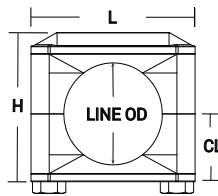

#### Base Mount Block Hangers - B24-BM

Tube O.D.	Line O.D. (in)	H (in)	L (in)	W (in)	CL (in)	304 Stainless Steel Part #
1/2"	.50	1.70	1.93	.75	.73	B24-BM-G050
3/4"	.75	1.70	1.93	.75	.73	B24-BM-G075
1"	1.00	1.70	1.93	.75	.73	B24-BM-G100
1-1/2"	1.50	2.19	2.49	.75	.97	B24-BM-G150
2"	2.00	2.69	2.99	.88	1.25	B24-BM-G200
2-1/2"	2.50	3.19	3.36	.88	1.49	B24-BM-G250
3"	3.00	3.97	3.99	.88	1.85	B24-BM-G300

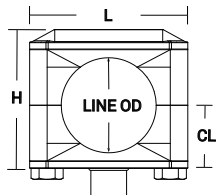

#### Base Mount Block Hanger Threaded Couplings - B24-BMTC

Tube Size	Line O.D. (in)	H (in)	L (in)	W (in)	CL (in)	Round Coupling		304 Stainless Steel Part #
						Height (in)	Thread	
1/2"	.50	1.70	1.93	.75	.73	.47	3/8"-16	B24-BMTC-G050
3/4"	.75	1.70	1.93	.75	.73	.47	3/8"-16	B24-BMTC-G075
1"	1.00	1.70	1.93	.75	.73	.47	3/8"-16	B24-BMTC-G100
1-1/2"	1.50	2.19	2.49	.75	.97	.47	3/8"-16	B24-BMTC-G150
2"	2.00	2.69	2.99	.88	1.25	.47	3/8"-16	B24-BMTC-G200
2-1/2"	2.50	3.19	3.36	.88	1.49	.59	1/2"-13	B24-BMTC-G250
3"	3.00	3.97	3.99	.88	1.85	.59	1/2"-13	B24-BMTC-G300

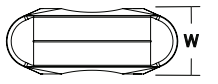
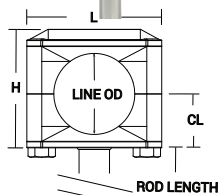

#### Base Mount Block Hanger Rod Mounts - B24-BMR6

Tube Size	Line O.D. (in)	H (in)	L (in)	W (in)	CL (in)	Rod (stock length)		304 Stainless Steel Part #
						Length (in)	O.D.	
1/2"	.50	1.70	1.93	.75	.73	6.00	.38	B24-BMR6-G050
3/4"	.75	1.70	1.93	.75	.73	6.00	.38	B24-BMR6-G075
1"	1.00	1.70	1.93	.75	.73	6.00	.38	B24-BMR6-G100
1-1/2"	1.50	2.19	2.49	.75	.97	6.00	.38	B24-BMR6-G150
2"	2.00	2.69	2.99	.88	1.25	6.00	.38	B24-BMR6-G200
2-1/2"	2.50	3.19	3.36	.88	1.49	6.00	.50	B24-BMR6-G250
3"	3.00	3.97	3.99	.88	1.85	6.00	.50	B24-BMR6-G300

M



## Tube Process Hex Hangers

### Process Hex Hanger Weld Mount - B24V-PH

Tube O.D.	Line O.D. (in)	H (in)	L (in)	W (in)	CL (in)	304 Stainless Steel With Acorn Nut Part #	304 Stainless Steel With Lock Nut Part #
1/2"	0.50	1.15	2.80	1.10	0.58	B24-PH-G050	B24-PHL-G050
3/4"	0.75	1.15	2.80	1.10	0.58	B24-PH-G075	B24-PHL-G075
1"	1.00	1.45	3.00	1.10	0.73	B24-PH-G100	B24-PHL-G100
1-1/2"	1.50	1.93	4.00	1.42	0.98	B24-PH-G150	B24-PHL-G150
2"	2.00	2.50	4.60	1.42	1.25	B24-PH-G200	B24-PHL-G200
2-1/2"	2.50	4.00	5.10	1.42	4.00	B24-PH-G250	B24-PHL-G250
3"	3.00	3.50	5.60	1.42	1.75	B24-PH-G300	B24-PHL-G300
4"	4.00	4.55	6.75	1.42	2.28	B24-PH-G400	B24-PHL-G400

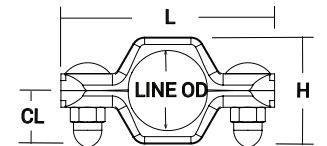
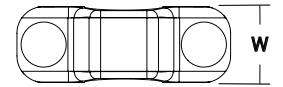

### Process Hex Hanger Weld Mount Threaded Coupling - B24V-PHC

Tube O.D.	Line O.D. (in)	H (in)	L (in)	W (in)	Rod (stock length)		304 Stainless Steel With Acorn Nut Part #	304 Stainless Steel With Lock Nut Part #
					Height (in)	Thread		
1/2"	0.50	1.15	2.80	1.10	0.47	3/8"-16	B24-PHC-G050	B24-PHC-PHCL
3/4"	0.75	1.15	2.80	1.10	0.47	3/8"-16	B24-PHC-G075	B24-PHC-G075
1"	1.00	1.45	3.00	1.10	0.47	3/8"-16	B24-PHC-G100	B24-PHCL-G100
1-1/2"	1.50	1.93	4.00	1.42	0.47	3/8"-16	B24-PHC-G150	B24-PHCL-G150
2"	2.00	2.50	4.60	1.42	0.59	1/2"-13	B24-PHC-G200	B24-PHCL-G200
2-1/2"	2.50	4.00	5.10	1.42	0.59	1/2"-13	B24-PHC-G250	B24-PHCL-G250
3"	3.00	3.50	5.60	1.42	0.59	1/2"-13	B24-PHC-G300	B24-PHCL-G300
4"	4.00	4.55	6.75	1.42	0.59	1/2"-13	B24-PHC-G400	B24-PHCL-G400

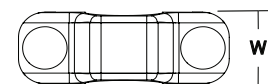
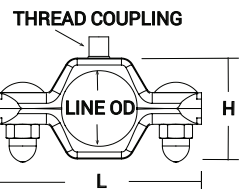

### Process Hex Hanger Weld Mount Rod Attached - B24V-PHR6

Tube O.D.	Line O.D. (in)	H (in)	L (in)	W (in)	Rod (stock length)		304 Stainless Steel With Acorn Nut Part #	304 Stainless Steel With Lock Nut Part #
					Length (in)	O.D. (in)		
1/2"	0.50	1.15	2.80	1.10	6	0.38	B24-PHR6-G050	B24-PHRL-PHR6L
3/4"	0.75	1.15	2.80	1.10	6	0.38	B24-PHR6-G075	B24-PHRL-G075
1"	1.00	1.45	3.00	1.10	6	0.38	B24-PHR6-G100	B24-PHR6L-G100
1-1/2"	1.50	1.93	4.00	1.42	6	0.38	B24-PHR6-G150	B24-PHR6L-G150
2"	2.00	2.50	4.60	1.42	6	0.50	B24-PHR6-G200	B24-PHR6L-G200
2-1/2"	2.50	4.00	5.10	1.42	6	0.50	B24-PHR6-G250	B24-PHR6L-G250
3"	3.00	3.50	5.60	1.42	6	0.50	B24-PHR6-G300	B24-PHR6L-G300
4"	4.00	4.55	6.75	1.42	6	0.63	B24-PHR6-G400	B24-PHR6L-G400

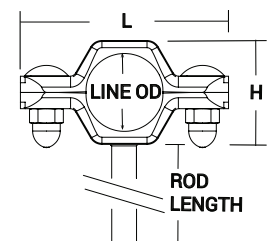

Wall Flanges

Flanges - B25

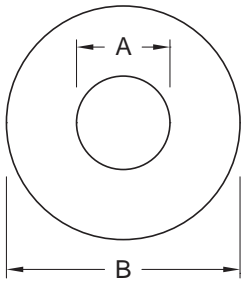

Tube O.D.	A (in)	B (in)	Wall Thickness (in)	304 Stainless Steel Part #
1/2"	.50	3.00	.065	B25-G050300
	.50	5.00		B25-G050500
3/4"	.75	3.00		B25-G075300
	.75	5.00		B25-G075500
1"	1.00	3.00		B25-G100300
	1.00	5.00		B25-G100500
1-1/2"	1.50	5.00		B25-G150500
2"	2.00	5.00		B25-G200500
2-1/2"	2.50	5.00		B25-G250500
3"	3.00	6.00		B25-G300600
4"	4.00	7.00		B25-G400700
5"	5.00	8.00		B25-G500800
6"	6.00	10.00		B25-G6001000
8"	8.00	12.00		B25-G8001200
10"	10.00	14.00		B25-G10001400
12"	12.00	16.00		B25-G12001600

## Dixon Sanitary Gauges

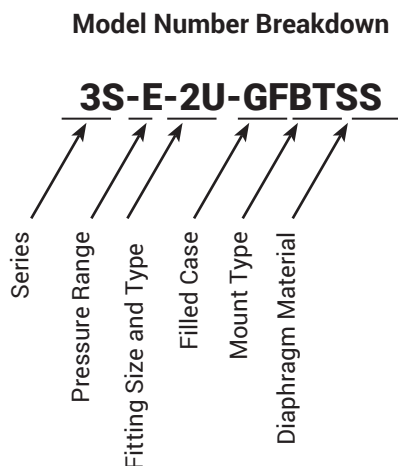
**Sizes**

- 1-1/2", 2", 2-1/2" or 3"

**Material**

- 316L stainless steel

**Features**

- Finishes: 3A sanitary
- Finishes: pharmaceutical

## Ordering Information

**Series**

- 3S**..... 3-1/2" Sanitary pressure gauge  
**5S**..... 5" Sanitary pressure gauge  
**3P**..... 3-1/2" Pharmaceutical pressure gauge  
**5P**..... 5" Pharmaceutical pressure gauge

**Pressure Range<sup>1</sup>**

- B**..... 0 to 30 PSI (2 BAR)  
**C**..... 0 to 60 PSI (4 BAR)  
**D**..... 0 to 100 PSI (7 BAR)  
**E**..... 0 to 160 PSI (11 BAR)  
**F**..... 0 to 200 PSI (14 BAR)  
**G**..... 0 to 300 PSI (21 BAR)  
**H**..... 0 to 400 PSI (28 BAR)  
**I**..... 0 to 600 PSI (41 BAR)  
**K**..... 0 to 1,000 PSI (70 BAR)

<sup>1</sup> Standard scales are in PSI only. For dual scales, add the letter B for PSI/BAR after the pressure range letter.

**Fitting Type<sup>2</sup>**

specify size in inches: 15, 2, 25, or 3

- I**..... male I-Line  
**J**..... female I-Line  
**R**..... RJT  
**S**..... #15 Bevel Seat sanitary male thread  
**T**..... #13H captive nut and #14 Bevel Seat  
**U**..... clamp  
**DIN**..... DIN according to DIN 11851 (*specify DIN40 or DIN50*)  
**SMS**..... SMS (*specify SMS38 or SMS51*)

<sup>2</sup> Specify size then type, i.e. 1-1/2" - 15

**Filled Case**

- GF**..... glycerine filled  
**NF**..... no fill (dry)

**Mount type**

- BT**..... bottom  
**RT**..... right side  
**LF**..... left side  
**TP**..... top  
**BK**..... back

**Diaphragm Material**

- SS**..... stainless steel



### Sanitary Pressure Gauges



3S-EB-2U-GFBTSS

**Sizes**

- Dial size: 3-1/2" or 5" diameter

**Materials**

- Case: 304 stainless steel
- Lens: polycarbonate

**Features**

- Accuracy: ± 1.5% of full scale
- Over range capacity: 30%
- Product contact: 316L stainless steel
- Surface finishes (product contact):  
Ra max = 25 microinches
- Standard fill: food grade glycerin
- Rezero feature: standard on pointer
- Shipping weight: approximately 3 lbs. (1.3 kg)

**Specification**

- Temperature limits: 0°F to 250°F (-18°C to 121°C)

**3-1/2" Gauge - (90 mm)**

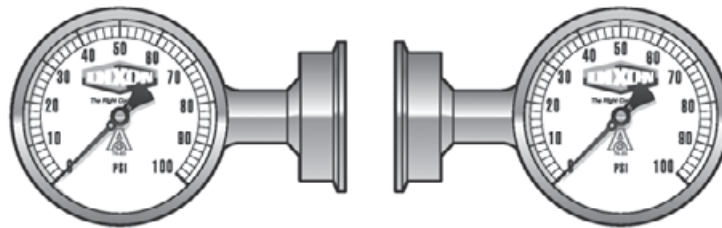
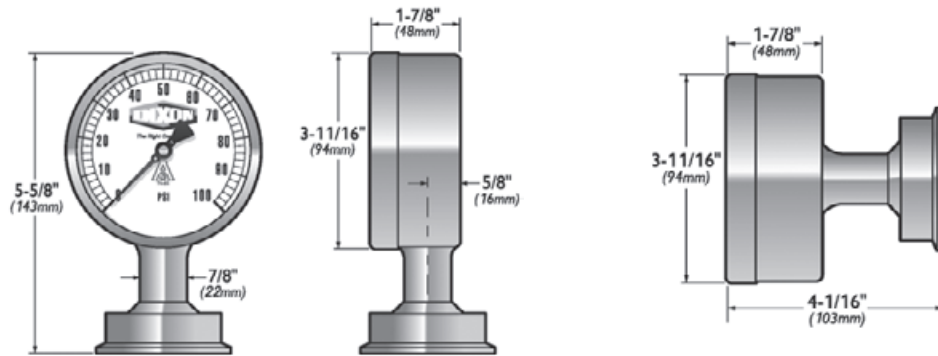

**5" Gauge - (120 mm)**

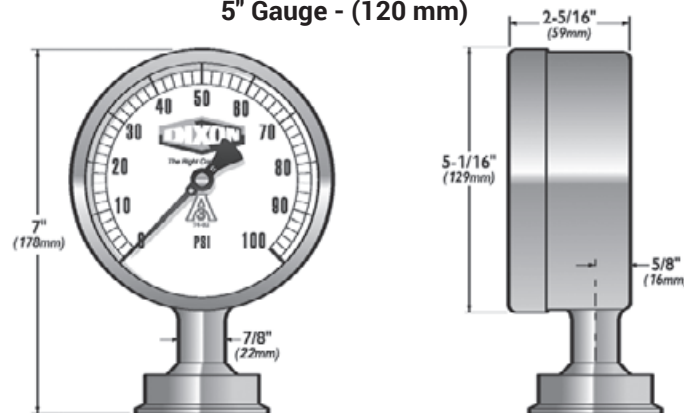

shown with 2" clamp

Product not returnable and no cancellations.

M

Sanitary Pressure Gauges



Part #	Dial Size	Pressure Range (PSI)	Clamp Size	Mount	
3S-B-15U-GFBTSS	3-1/2"	0-30	1-1/2"	bottom	
3S-C-15U-GFBTSS		0-60			
3S-D-15U-GFBTSS		0-100			
3S-E-15U-GFBTSS		0-160			
3S-F-15U-GFBTSS		0-200			
3S-G-15U-GFBTSS		0-300			
3S-B-15U-GFBKSS		0-30			back
3S-C-15U-GFBKSS		0-60			
3S-D-15U-GFBKSS		0-100			
3S-E-15U-GFBKSS		0-160			
3S-F-15U-GFBKSS		0-200			
3S-G-15U-GFBKSS		0-300			
3S-B-2U-GFBTSS		3-1/2"	0-30	2"	
3S-C-2U-GFBTSS			0-60		
3S-D-2U-GFBTSS	0-100				
3S-E-2U-GFBTSS	0-160				
3S-F-2U-GFBTSS	0-200				
3S-G-2U-GFBTSS	0-300				
3S-B-2U-GFBKSS	0-30		back		
3S-C-2U-GFBKSS	0-60				
3S-D-2U-GFBKSS	0-100				
3S-E-2U-GFBKSS	0-160				
3S-F-2U-GFBKSS	0-200				
3S-G-2U-GFBKSS	0-300				



Product not returnable and no cancellations.



## Pharmaceutical Pressure Gauges



3P-D-15U-GBFT

### Sizes

- Dial size: 3-1/2" or 5" diameter

### Materials

- Lens: polycarbonate
- Case: 304 stainless steel

### Features

- Accuracy:  $\pm 0.75\%$  of full scale
- Over range capacity: 30%
- Product contact: 316L stainless steel
- Surface finishes (product contact): Ra max = 8 microinches
- Standard fill: food grade glycerin
- Rezero feature: standard on pointer
- Shipping weight: approximately 3 lbs. (1.3 kg)

### Specification

- Temperature limits: 0°F to 250°F (-18°C to 121°C)

### 3-1/2" Gauge - (90 mm)

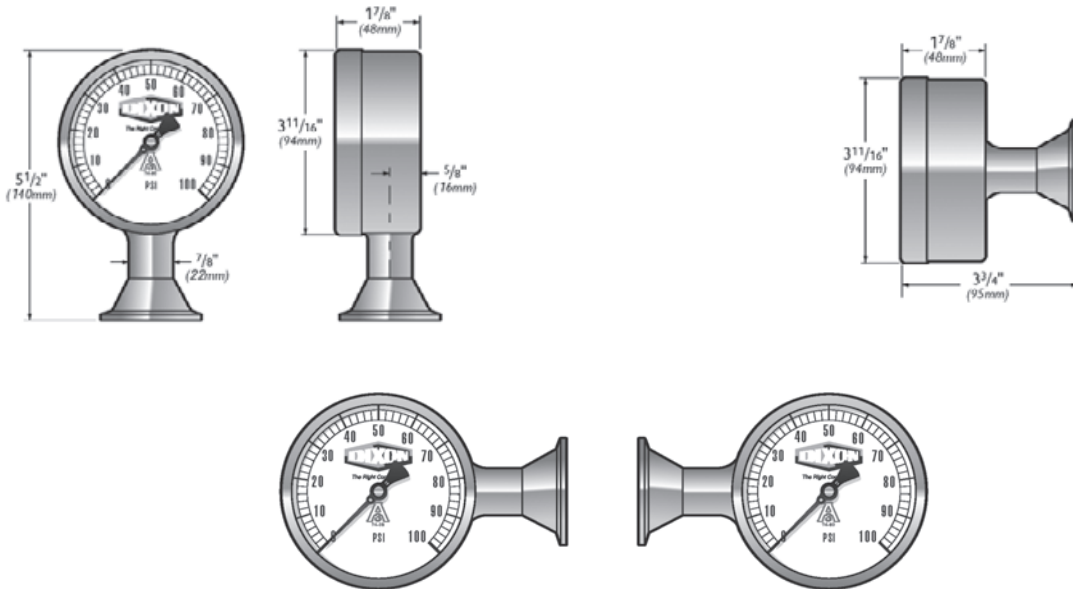

### 5" Gauge - (120 mm)

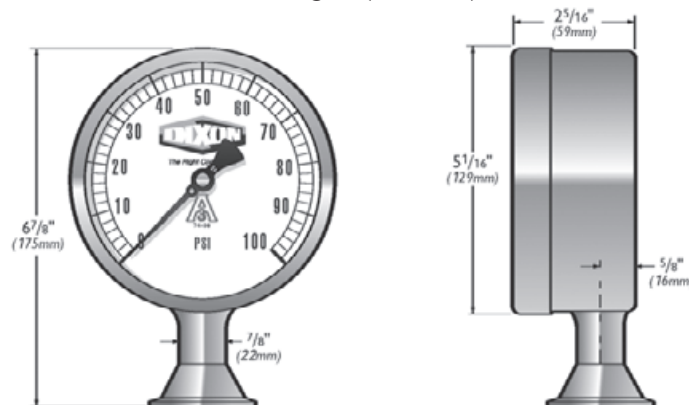

Product not returnable and no cancellations.

## Homogenizer Pressure Gauges

### Size

- Dial size: 5"

### Features

- Lexan® lens virtually impervious to cracks and breakage
- Unique pulsation dampening system insulates the gauge movement from the punishing pulsations of a homogenizer
- Glycerine fill standard
- Waterproof construction
- CIP certified
- True zero with re-zero standard

### Materials

- Product contact: 316L stainless steel
- Case: 304 stainless steel
- Lens: Lexan®

### Specifications

- Ranges up to **15,000 PSI**
- Maximum temperature: **250°F (121°C)**



### Model Number Breakdown

**5H - V - 03**

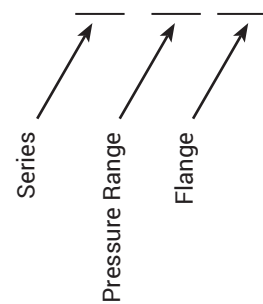

### Ordering Information

#### Series

**5H** ..... 5" Sani-Flow homogenizer pressure gauge

#### Pressure Range<sup>1</sup>

- K** ..... 0 to 1,000 PSI (70 BAR)
- T** ..... 0 to 2,500 PSI (170 BAR)
- U** ..... 0 to 3,000 PSI (205 BAR)
- V** ..... 0 to 5,000 PSI (350 BAR)
- Y** ..... 0 to 7,500 PSI (520 BAR)
- W** ..... 0 to 10,000 PSI (700 BAR)
- X** ..... 0 to 15,000 PSI (1000 BAR)

<sup>1</sup> Standard scales are in PSI only. For dual scales, after the pressure range add the letter B for PSI/BAR, K for PSI/Kg/cm3, P for PSI/KPa (see examples below).

#### Examples

**5H-V-03** - describes a 5" Sani-Flow homogenizer pressure gauge, **0 to 5,000 PSI**, a 1-1/8" thick flange, and a glycerine filled case

**5H-WB-01** - describes a 5" Sani-Flow homogenizer pressure gauge, dual scale **0 to 10,000 PSI/0 to 700 BAR**, no flange, and a glycerine filled case

#### Flange

- 01** ..... no flange
- 02** ..... 7/8" thick 2 bolt flange
- 03** ..... 1-1/8" thick 2 bolt flange
- 04** ..... 1/2" thick 4 bolt flange
- 05** ..... 3/4" thick 4 bolt flange
- 09** ..... 1.66" thick laboratory homogenizer flange

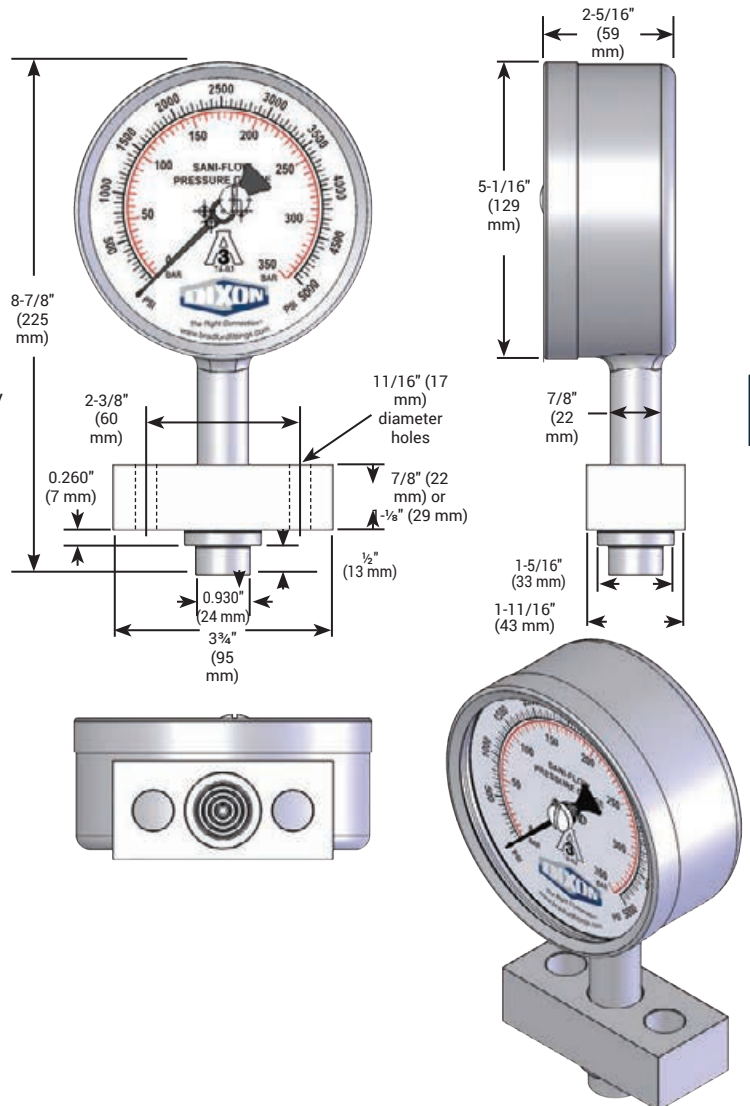

Product not returnable and no cancellations.



### Sanitary Digital Thermometers

#### Model Number Breakdown DT-2U-BT-DF-10

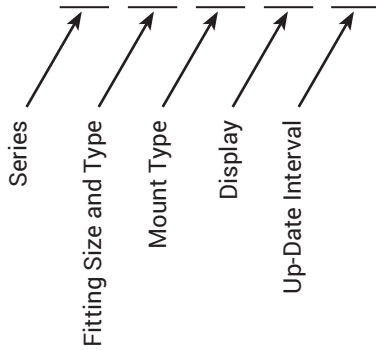

**Sizes**

- Dial size: 3-1/2" diameter
- LCD display: 0.6"

**Materials**

- Product contact: 316L stainless steel
- Case: 304 stainless steel
- Lens: 1/4" polycarbonate

**Features**

- Accuracy: ±1°
- Surface finish: Ra max.is 8 microinches
- Battery size / life: standard AAA/3 years
- Shipping weight: approximately 3 lbs.

**Specifications**

- Temperature limits: -58°F to 302°F (-50°C to 150°C)
- Ambient operating limits: -4°F to 140°F (-20°C to 60°C)
- Resolution: 0.1° (-58° thru 199.9°)

**Ordering Information**

**Series**

DT ..... Sanitary digital thermometer

**Fitting Type<sup>1</sup>**

Sizes available: 75, 15, 2, 25, 3, and 4

- I..... male I-Line
- T..... #13H captive nut and #14 bevel seat
- U..... clamp

<sup>1</sup> Specify size then type, i.e. 1-1/2" = 15U

**Mount type**

- BT ..... bottom
- RT ..... right side
- LF..... left side
- TP ..... top
- BK..... back
- BTR..... remote fitting

**Display**

- DF ..... F (Fahrenheit) *standard*
- DC..... C (Celsius)

**Up-Date Interval**

- 1 ..... one second (1 year battery life)
- 10..... ten second (3 year battery life)



M

**Dimensions**

**LEFT SIDE MOUNT**



**RIGHT SIDE MOUNT**



**BACK MOUNT**

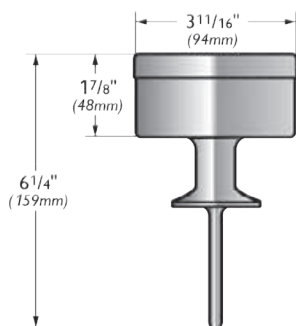

**BOTTOM MOUNT**

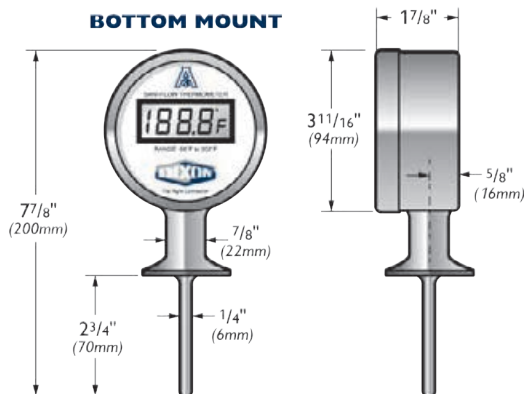

Ordering code shown with clamp configuration "U". See ordering information for other types available.

Size	Probe Length <sup>1</sup>	Code
3/4"	2-3/8"	75U
1"	2-5/5"	1U
1-1/2"	2-3/4"	15U
2"	3-1/2"	2U
2-1/2"	3-1/2"	25U
3"	3-3/4"	3U
4"	4-1/2"	4U

<sup>1</sup> Custom probe lengths are available

Product not returnable and no cancellations.





## Sanitary RTDs and Temperature Transmitters

### Materials

- Product contact: 316L stainless
- Exterior surfaces 316L with a near mirror finish

### Features

- Standard 12mm industrial connector with gold-plated contacts for maximum corrosion resistance and cleanability
- Sensor elements are accurate up to +/-0.1C

### Specifications

- RTD – temperature range: -58°F to 392°F (-50°C to 200°C)
- TT – temperature range: -22°F to 302°F (-30°C to 150°C)

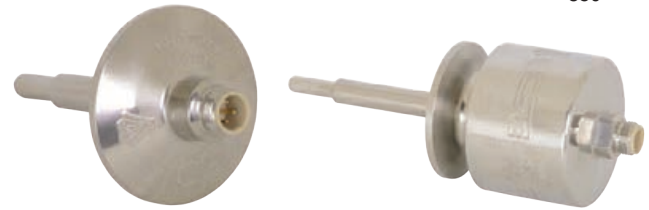

Sanitary RTD

Temperature transmitter

### Ordering Information

#### Series

- RTD..... Sani-Flow resistive temperature device
- TT..... Sani-Flow temperature transmitter

### Sanitary Fittings

Fittings available in 5, 75, 15, 20, 25, 30, and 40

- H..... G & H 'H' line male
- I..... Cherry-Burrell male I-line
- K..... APC 'K' clamp
- Q..... Cherry-Burrell Q-line
- T..... #13H captive nut and #14 bevel seat
- U..... Tri-clamp®

- Specify size, then adapter type such as 15U for 1-1/2" Tri-clamp® adapter
- For special probes, add SP and the required probe length at the end of the part number, such as SP2.75 for a 2-3/4" long probe

### Other Fittings

Specify probe length

- A..... air space
- M..... umbrella fittings
- NPT..... 1/4", 3/8", 1/2", 5/8", or 3/4" pipe thread
- PW..... projectile well with 1-1/4"-18 UNEF male thread
- SP..... split ferrule
- VP..... VAT well fitting with #13H captive nut
- OF..... no fitting

### Element<sup>1</sup>

- E1..... single element
- E2..... dual element

<sup>1</sup> Available for RTD only

### Model Number Breakdown RTD - 15U - E1

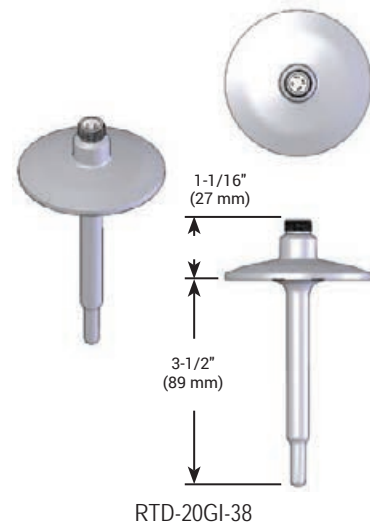
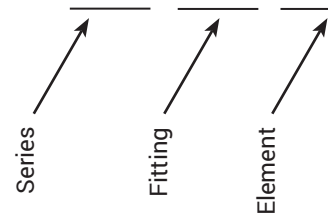

RTD-20GI-38

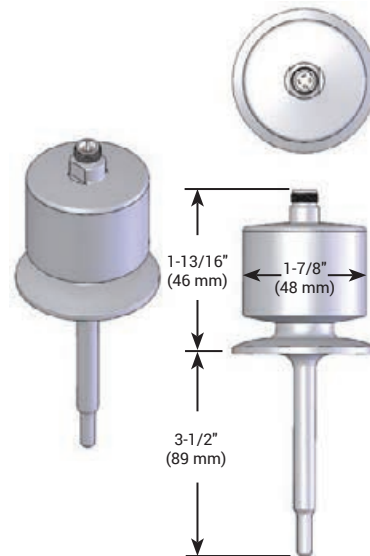

TT-20-G1

Product not returnable and no cancellations.

## Vacuum Fittings KF Flanges and Fittings



**Application**

- Vacuum sealing for 1/2" - 2" O.D. tubing in the semiconductor industry

**Sizes**

- KF10 - KF50

**Features**

- Each assembly contains two identical flanges and a centering ring assembly and is clamped together with a thumbscrew clamp
- Coupling features prevent O-ring collapse and keep the assembly aligned
- KF flanges are compatible with other ISO-KF-QF vacuum flange manufacturers' components
- All fittings are IPA cleaned and bagged in a controlled environment
- MTRs available

**Materials**

- Fittings: 304 or 316L stainless steel
- Clamps: aluminum
- O-ring: FKM

**Specifications**

- Maximum temperature: 302°F (150°C)
- Helium leakage testing to 1x10<sup>-8</sup> Torr
- Standards followed: ISO2681



**Part Number Key**

**Example: DVF - A 10 G A**

(KF10, 304 stainless steel bored flange)

Product Line	-	Series	Size	Material	Type
DVF		A - KF B - ISO C - Fitting	10 - KF10 16 - KF16 25 - KF25 40 - KF40 50 - KF50	G - 304 stainless steel R - 316L stainless steel <sup>1</sup> L - Aluminum (clamp only)	A - KF bored flange
					B - KF blank flange
					C - KF short weld flange
					D - KF long weld flange
					E - KF centering ring assembly
					F - KF overpressure ring
					G - KF flex bellow
					H - KF clamp

<sup>1</sup> Minimum quantity requirements apply.

**KF Bored Flanges**

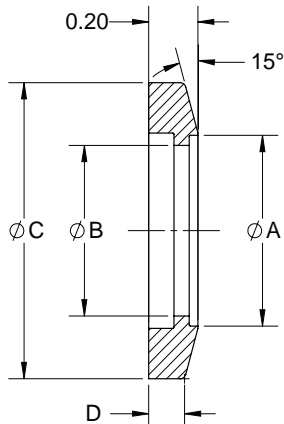

Flange Size	A (in)	B (in)	C (in)	D (in)	304 Stainless Steel Part #
KF10	0.51	0.45	1.18	0.12	DVF-A10GA
KF16	0.76	0.68	1.18	0.11	DVF-A16GA
KF25	1.01	0.94	1.58	0.13	DVF-A25GA
KF40	1.51	1.43	2.17	0.12	DVF-A40GA
KF50	2.01	1.94	2.95	0.12	DVF-A50GA

### Vacuum Fittings

#### KF Blank Flanges

Flange Size	A (in)	B (in)	304 Stainless Steel Part #
KF10	1.18	0.12	DVF-A10GB
KF16	1.18	0.11	DVF-A16GB
KF25	1.58	0.13	DVF-A25GB
KF40	2.17	0.12	DVF-A40GB
KF50	2.95	0.12	DVF-A50GB

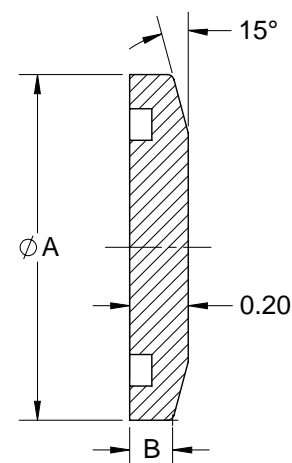

#### KF Short Weld Flanges

Flange Size	A (in)	B (in)	C (in)	D (in)	E (in)	304 Stainless Steel Part #
KF10	1.18	0.48	0.37	0.50	0.50	DVF-A10GC
KF16	1.18	0.67	0.62	0.75	0.50	DVF-A16GC
KF25	1.58	1.03	0.87	1.00	0.50	DVF-A25GC
KF40	2.17	1.62	1.37	1.50	0.75	DVF-A40GC
KF50	2.95	2.05	1.87	2.00	0.75	DVF-A50GC

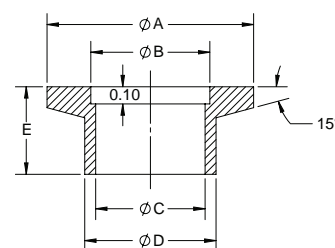

#### KF Long Weld Flanges

Flange Size	A (in)	B (in)	C (in)	D (in)	304 Stainless Steel Part #
KF10	1.18	0.48	0.37	0.50	DVF-A10GD
KF16	1.18	0.67	0.62	0.75	DVF-A16GD
KF25	1.58	1.03	0.87	1.00	DVF-A25GD
KF40	2.17	1.62	1.37	1.50	DVF-A40GD
KF50	2.95	2.05	1.87	2.00	DVF-A50GD

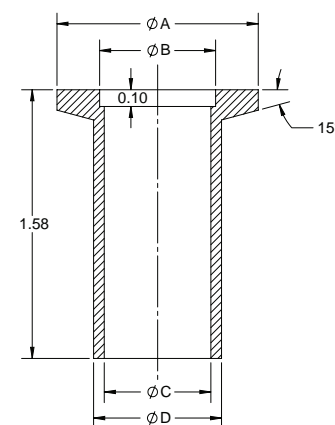

#### KF Centering Ring Assemblies

Flange Size	A (in)	B (in)	304 Stainless Steel with FKM O-ring Part #
KF10	0.48	0.44	DVF-A10GE
KF16	0.67	0.63	DVF-A16GE
KF25	1.02	0.98	DVF-A25GE
KF40	1.61	1.57	DVF-A40GE
KF50	2.05	1.97	DVF-A50GE

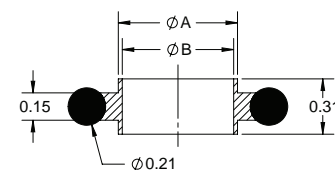

Vacuum Fittings

KF Overpressure Rings

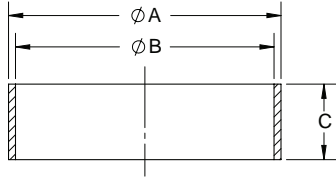

Flange Size	A (in)	B (in)	C (in)	Max PSIG	304 Stainless Steel Part #
KF10	1.25	1.19	0.35	100	DVF-A1016GF
KF16	1.25	1.19	0.35	100	DVF-A1016GF
KF25	1.66	1.58	0.35	100	DVF-A25GF
KF40	2.26	2.18	0.35	75	DVF-A40GF
KF50	2.77	2.64	0.15	50	DVF-A50GF

KF Flex Bellows (Formed)

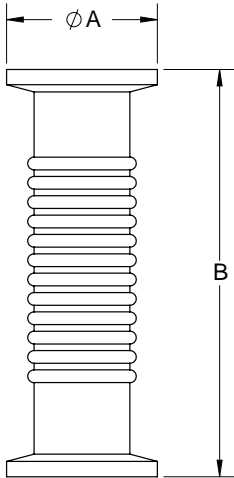

Flange Size	A (in)	B (in)	304 Stainless Steel Part #
KF10	1.18	3.20	DVF-A10GG
KF16	1.18	3.20	DVF-A16GG
KF25	1.58	4.20	DVF-A25GG
KF40	2.17	4.20	DVF-A40GG
KF50	2.95	4.20	DVF-A50GG

M

KF Clamps

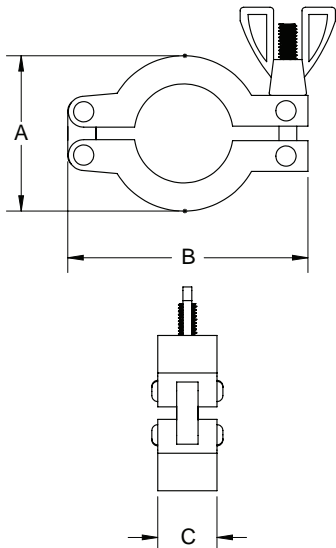

Flange Size	A (in)	B (in)	C (in)	Aluminum Part #
KF10	1.69	2.39	0.63	DVF-A1016LH
KF16	1.69	2.39	0.63	DVF-A1016LH
KF25	2.14	2.80	0.63	DVF-A25LH
KF40	2.75	3.44	0.63	DVF-A40LH
KF50	3.50	4.25	0.71	DVF-A50LH

## Vacuum Fittings

### ISO Flanges and Fittings

#### Application

- Vacuum sealing for 2-1/2" - 10" O.D. tubing in the semiconductor industry

#### Sizes

- ISO63 - ISO250

#### Features

- Each assembly contains two identical flanges and a centering ring assembly and is joined together by clamps
- Centering ring keeps the flanges in line and prevents the O-ring from being pushed in by atmospheric pressure
- Multiple clamps must be used to ensure a sturdy connection
- ISO fittings are compatible with other manufacturers' ISO-KF-QF vacuum flanges
- All fittings are IPA cleaned and bagged in a controlled environment
- MTRs available

#### Materials

- Fittings: 304 or 316L stainless steel
- Clamps: aluminum
- O-ring: FKM

#### Specifications

- Maximum temperature: 302°F (150°C)
- Helium leakage testing to 1x10<sup>-8</sup> Torr
- Standards followed: ISO2681



#### Part Number Breakdown

Example: **DVF - B 63 G A**

(ISO63, 304 stainless steel bored flange)

Product Line	-	Series	Size	Material	Type
DVF		A - KF B - ISO C - Fitting	63 - ISO63 80 - ISO80 100 - ISO100 160 - ISO160 200 - ISO200 250 - ISO250	G - 304 stainless steel R - 316L stainless steel <sup>1</sup> L - Aluminum (clamp only)	A - ISO bored flange B - ISO blank flange E - ISO centering ring assembly G - ISO flexible bellow H - ISO double claw clamp

<sup>1</sup> Minimum quantity requirements apply.

#### ISO Bored Flanges

Flange Size	A (in)	B (in)	C (in)	D (in)	304 Stainless Steel Part #
ISO63	3.74	0.47	2.44	2.51	DVF-B63GA
ISO80	4.33	0.47	2.94	3.01	DVF-B80GA
ISO100	5.12	0.47	3.91	4.02	DVF-B100GA
ISO160	7.09	0.47	5.87	6.03	DVF-B160GA
ISO200	9.45	0.47	7.87	8.03	DVF-B200GA
ISO250	11.42	0.47	9.88	10.02	DVF-B250GA

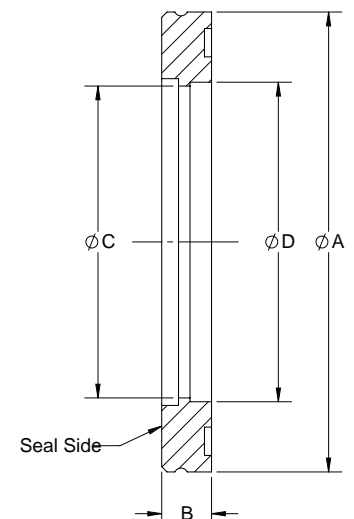

Vacuum Fittings

ISO Blank Flanges

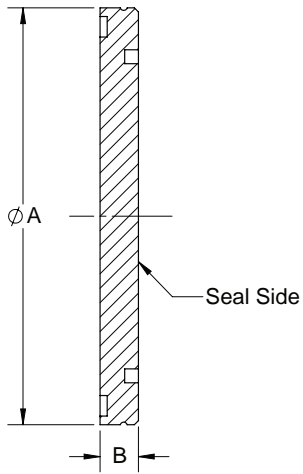

Flange Size	A (in)	B (in)	304 Stainless Steel Part #
ISO63	3.74	0.47	DVF-B63GB
ISO80	4.33	0.47	DVF-B80GB
ISO100	5.12	0.47	DVF-B100GB
ISO160	7.09	0.47	DVF-B160GB
ISO200	9.45	0.47	DVF-B200GB
ISO250	11.42	0.47	DVF-B250GB

ISO Centering Rings Assemblies

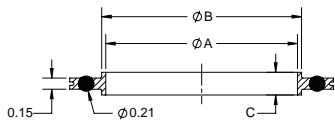

Flange Size	A (in)	B (in)	C (in)	304 Stainless Steel Centering Ring FKM O-ring Aluminum Spacer Ring Part #
ISO63	2.63	2.74	0.31	DVF-B63GE
ISO80	3.14	3.25	0.31	DVF-B80GE
ISO100	3.89	4.00	0.31	DVF-B100GE
ISO160	5.90	6.01	0.31	DVF-B160GE
ISO200	8.26	8.37	0.31	DVF-B200GE

ISO Flexible Bellow (Formed)

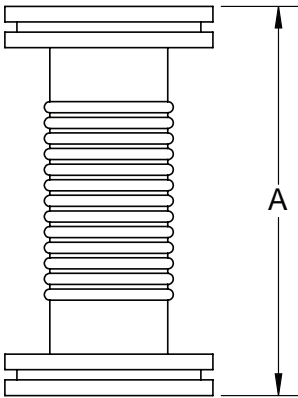

Flange Size	A (in)	Compressed Length (in)	304 Stainless Steel Part #
ISO63	7.00	6.00	DVF-B63GG
ISO80	7.00	6.00	DVF-B80GG
ISO100	7.00	6.00	DVF-B100GG
ISO160	7.00	6.00	DVF-B160GG
ISO200	7.00	6.00	DVF-B200GG
ISO250	13.50	10.50	DVF-B250GG

ISO Double Claw Clamps

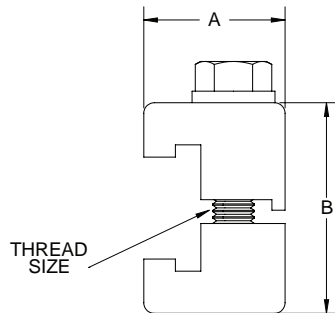

Flange Size	A (in)	B (in)	Thread Size	Qty. of Clamps Required	Aluminum Part #
ISO63	0.94	1.96	5/16"-18	3 - 4	DVF-B63100LH
ISO80	0.94	1.96	5/16"-18	4 - 8	DVF-B63100LH
ISO100	0.94	1.96	5/16"-18	4 - 8	DVF-B63100LH
ISO160	1.10	1.96	5/16"-18	4 - 8	DVF-B160250LH
ISO200	1.10	1.96	5/16"-18	6 - 12	DVF-B160250LH
ISO250	1.10	1.96	5/16"-18	6 - 12	DVF-B160250LH

NOTE: ISO clamps are sold in multiples of 4.

M

## Vacuum Weld Fittings

Each part is crafted with precision to ensure a leak-free fit. All fittings are IPA cleaned and bagged in a controlled environment.

### Application

- Vacuum sealing weld fittings used in the semiconductor industry

### Sizes

- 1/2" - 6"

### Feature

- Material Test Reports (MTRs) available

### Materials

- Fittings: 304 or 316L stainless steel

### Specifications

- Helium leakage testing to  $1 \times 10^{-8}$  Torr
- Maximum temperature: 302°F (150°C)
- Standards followed: ASTM A270, ASTM A269, and ASME SA270



### Part Number Key

Example: **DVF - C 050 G 1 Q**

(1/2" 90° elbow, polished weld fitting, 304 stainless steel)

Product Line	-	Series	Size	Material	Finish	Type
DVF		A - KF B - ISO C - Fitting	050 - 1/2" 075 - 3/4" 100 - 1" 150 - 1-1/2" 200 - 2" 250 - 2-1/2" 300 - 3" 400 - 4" 600 - 6"	G - 304 stainless steel R - 316L stainless steel <sup>1</sup>	1 - polished 2 - bead blast <sup>1</sup>	Q - 90° elbow R - 90° elbow with tangents S - 45° elbow T - 45° elbow with tangents U - concentric reducer V - tee W - reducing tee

<sup>1</sup> Minimum quantity requirements apply.

### Weld 90° Elbows

O.D.	A (in)	R (in)	304 Stainless Steel Part #
1/2"	0.75	0.75	DVF-C050G1Q
3/4"	1.00	1.00	DVF-C075G1Q
1"	1.50	1.50	DVF-C100G1Q
1-1/2"	2.25	2.25	DVF-C150G1Q
2"	3.00	3.00	DVF-C200G1Q
2-1/2"	3.75	3.75	DVF-C250G1Q
3"	4.50	4.50	DVF-C300G1Q
4"	6.00	6.00	DVF-C400G1Q
6"	9.00	9.00	DVF-C600G1Q

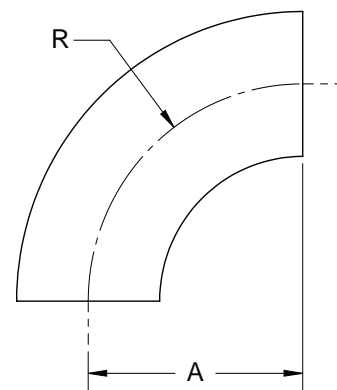

Vacuum Fittings

Weld 90° Elbows with Tangents

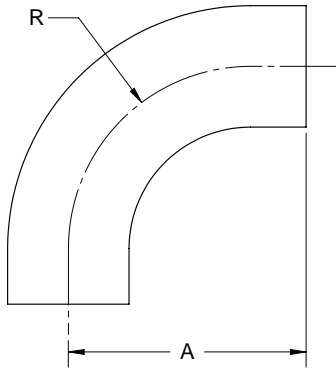

O.D.	A	R	304 Stainless Steel Part #
3/4"	1.42	1.00	DVF-C075G1R
1"	1.82	1.50	DVF-C100G1R
1-1/2"	2.94	2.25	DVF-C150G1R
2"	4.06	3.00	DVF-C200G1R
2-1/2"	5.19	3.75	DVF-C250G1R
3"	6.31	4.50	DVF-C300G1R
4"	8.31	6.00	DVF-C400G1R
6"	11.50	9.00	DVF-C600G1R

Weld 45° Elbows

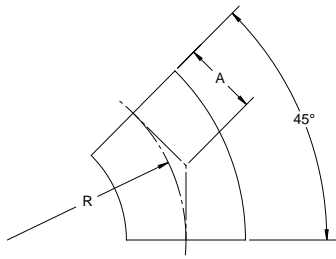

O.D.	A (in)	R (in)	304 Stainless Steel Part #
1/2"	0.31	0.75	DVF-C050G1S
3/4"	0.41	1.00	DVF-C075G1S
1"	0.62	1.50	DVF-C100G1S
1-1/2"	0.93	2.25	DVF-C150G1S
2"	1.25	3.00	DVF-C200G1S
2-1/2"	1.53	3.75	DVF-C250G1S
3"	1.84	4.50	DVF-C300G1S
4"	2.50	6.00	DVF-C400G1S
6"	3.73	9.00	DVF-C600G1S

Weld 45° Elbows with Tangents

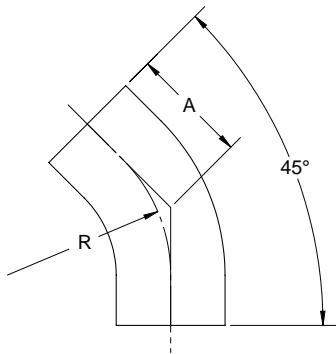

O.D.	A (in)	R (in)	304 Stainless Steel Part #
3/4"	0.76	1.00	DVF-C075G1T
1"	1.19	1.50	DVF-C100G1T
1-1/2"	1.63	2.25	DVF-C150G1T
2"	2.31	3.00	DVF-C200G1T
2-1/2"	3.00	3.75	DVF-C250G1T
3"	3.68	4.50	DVF-C300G1T
4"	4.81	6.00	DVF-C400G1T
6"	7.33	9.00	DVF-C600G1T

M



## Vacuum Fittings

### Concentric Reducers with Tangents

O.D.	A (in)	304 Stainless Steel Part #
1" x 3/4"	1.38	DVF-C100075G1U
1-1/2" x 3/4"	2.38	DVF-C150075G1U
1-1/2" x 1"	2.38	DVF-C150100G1U
2" x 1"	2.38	DVF-C200100G1U
2" x 1-1/2"	2.38	DVF-C200150G1U
2-1/2" x 1-1/2"	2.38	DVF-C250150G1U
2-1/2" x 2"	2.38	DVF-C250200G1U
3" x 1-1/2"	3.63	DVF-C300150G1U
3" x 2"	3.63	DVF-C300200G1U
3" x 2-1/2"	3.63	DVF-C300250G1U
4" x 2"	3.63	DVF-C400200G1U
4" x 2-1/2"	3.63	DVF-C400250G1U
4" x 3"	3.63	DVF-C400300G1U

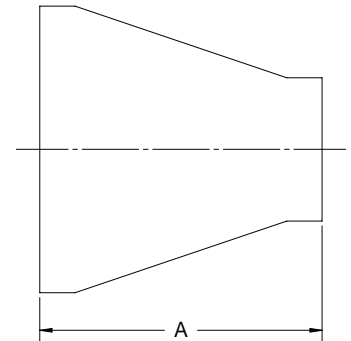

### Weld Tees

O.D.	A (in)	304 Stainless Steel Part #
1/2"	.75	DVF-C050G1V
3/4"	1.00	DVF-C075G1V
1"	1.88	DVF-C100G1V
1-1/2"	2.25	DVF-C150G1V
2"	3.00	DVF-C200G1V
2-1/2"	3.00	DVF-C250G1V
3"	3.25	DVF-C300G1V
4"	3.88	DVF-C400G1V
6"	5.00	DVF-C600G1V

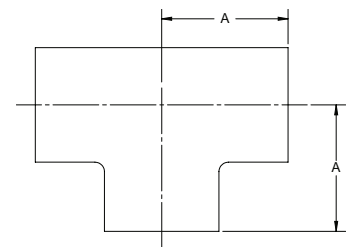
**M**

### Weld Reducing Tees

O.D.	A (in)	B (in)	304 Stainless Steel Part #
1" x 3/4"	1.88	2.13	DVF-C100075G1W
1-1/2" x 3/4"	2.25	2.25	DVF-C150075G1W
1-1/2" x 1"	2.25	2.38	DVF-C150100G1W
2" x 1"	3.00	2.38	DVF-C200100G1W
2" x 1-1/2"	3.00	2.38	DVF-C200150G1W
2-1/2" x 1-1/2"	3.00	2.50	DVF-C250150G1W
2-1/2" x 2"	3.00	2.75	DVF-C250200G1W
3" x 1-1/2"	3.25	3.25	DVF-C300150G1W
3" x 2"	3.25	3.00	DVF-C300200G1W
3" x 2-1/2"	3.25	3.25	DVF-C300250G1W
4" x 1-1/2"	3.88	3.50	DVF-C400150G1W
4" x 2"	3.88	4.00	DVF-C400200G1W
4" x 2-1/2"	3.88	3.75	DVF-C400250G1W
4" x 3"	3.88	3.75	DVF-C400300G1W
6" x 3"	5.00	4.75	DVF-C600300G1W
6" x 4"	5.00	4.88	DVF-C600400G1W

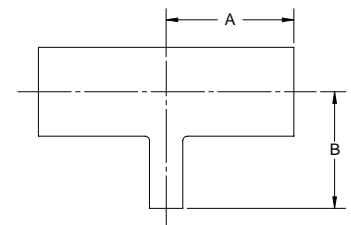

### Vacuum Fittings

#### MTR - Material Test Reports

An MTR is a report that contains information about the raw materials, chemical properties, and mechanical properties of a part. Dixon Sanitary provides material test reports upon request. Here's how you can access them:

##### Each MTR will contain:

- Part number and part description
- Material and material standards
- Heat number
- Chemical properties
- Mechanical properties
- Job number



##### To retrieve an MTR by QR code:

1. Scan the QR code on the product packaging
2. Enter the job number (found on the product's packaging bag)
3. Review the MTR

##### To retrieve an MTR at [dixonvalve.com](https://www.dixonvalve.com):

1. Go to [dixonvalve.com/knowledge-center/interactive-tools/mtr](https://www.dixonvalve.com/knowledge-center/interactive-tools/mtr)
2. Enter the job number (found on the product's packaging bag)
3. Review the MTR

M

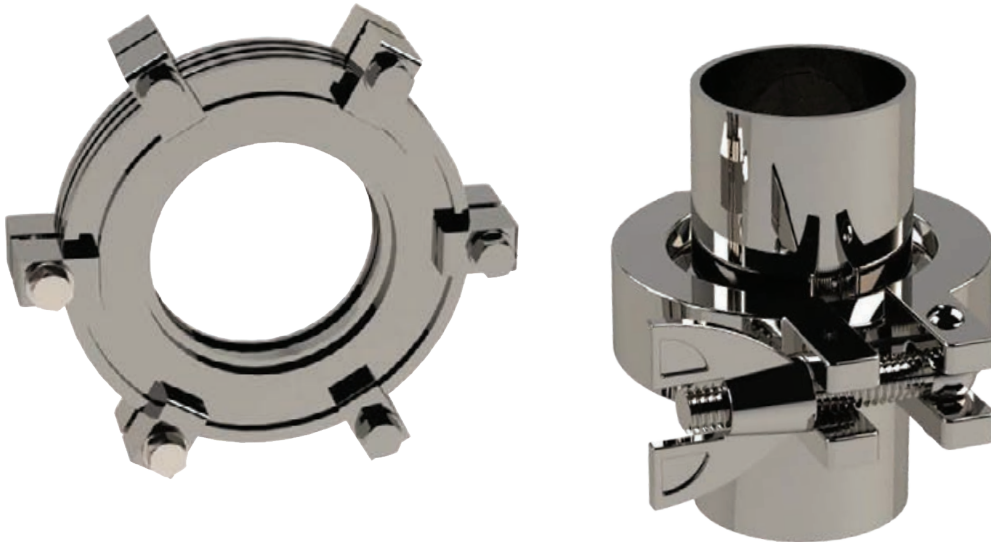

## Breakaway Couplings - Clamp

### Application

- Minimizes damage associated with pull-away and drive-away incidents

### Features

- Designed to be installed between a fixed point and a hose
- 13kN break load bolts standard; other break loads available
- Coupling breaks away with an excessive load
- Other sizes/connection available

### Materials

- 316 stainless steel polished to standard <32Ra, 3A finish
- Clamp gasket: EPDM standard, optional material available

### Specification

- Working pressure: **350 PSI @ 70°F (21°C)**



Size	316 Stainless Steel Part #
2"	SBC-E200CC13
3"	SBC-E300CC13

## Breakaway Couplings - Bevel Seat

### Application

- Minimizes damage associated with pull-away and drive-away incidents

### Features

- Designed to be installed between a fixed point and a hose
- 13kN break load bolts standard; other break loads available
- Coupling breaks away with an excessive load
- Other sizes / connections available

### Materials

- 316 stainless steel polished to standard <32Ra, 3A finish
- Clamp gasket: EPDM standard; optional material available

### Specification

- Working pressure: **350 PSI @ 70°F (21°C)**

Size	316 Stainless Steel Part #
2"	SBC-E200TP13
3"	SBC-E300TP13

**M**

## Spray Balls

### Rotating - SRH

#### Application

- Ideal for cleaning all types of tanks and vessels

#### Features

- Stainless steel ball bearings eliminate rust
- Cleaning solution lubricates unit
- Mirror-like finish (O.D.)
- Spray pattern: 360°

#### Specification

- Available connections: clamp and NPT

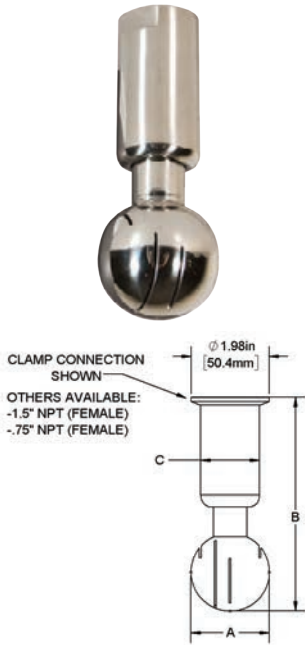

Size	Type	304 Stainless Steel Part #	316L Stainless Steel Part #
3/4"	NPT	SRH360NPT-G075	---
1-1/2"	NPT	---	SRH360NPT-R150
	clamp	SRH360CMP-G150	SRH360CMP-R150

### Stationary - STC

#### Application

- Typically used in food and beverage industries for cleaning storage tanks

#### Features

- Heavy duty 316L stainless steel construction provides longer life
- Stationary - designed to be mounted to a tube or pipe
- 2 mm spray holes
- Various spray patterns available (blanks available as special order)

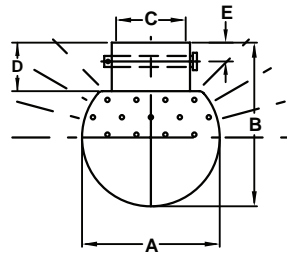

180° Top Pattern

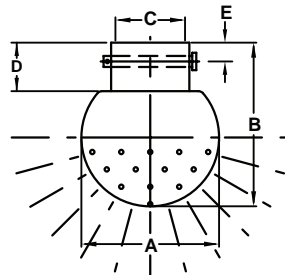

180° Bottom Pattern

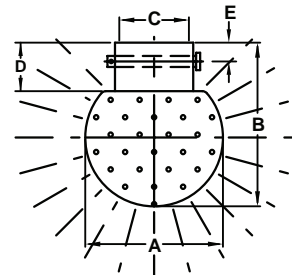

360° Pattern

Size	Pin Length	Spray Pattern	Dimensions					Pin Size (in)	316L Stainless Steel Part #
			A (in)	B (in)	C (in)	D (in)	E (in)		
1"	1.47"	360°	2.50	3.04	1.005	.975	.445	.226	STC-360-R100
1-1/2"	1.95"	360°	2.95	3.55	1.505	1.050	.445	.226	STC-360-R150
1"	1.47"	180° bottom	3.54	2.95	1.005	.975	.445	.226	STC-180B-R100
1-1/2"	1.95"	180° bottom	3.54	2.95	1.505	.975	.445	.226	STC-180B-R150
1"	1.47"	180° top	3.54	2.95	1.005	.975	.445	.226	STC-180T-R100
1-1/2"	1.95"	180° top	3.54	2.95	1.505	.975	.445	.226	STC-180T-R150

### Repair Kits

#### Feature

- Repair kit contains
  - (1) pin
  - (1) R clip

Size	Part #
1"	STC-RK100
1-1/2"	STC-RK150

M

## Sight Glasses

### Sizes

- 1" - 6" O.D. tube

### Materials

- Body: 316L stainless steel
- Sight glass: Borosilicate glass or polycarbonate
- Gaskets: white nitrile rubber or FKM
- 32Ra sanitary finish, I.D. and O.D.

### In-line - B54BMP

### Specifications

- Various end configurations are available: clamp, weld, bevel seat, John Perry, I-Line and Q-Line
- Maximum temperature: 200°F (93°C)

Tube O.D.	A (in)	B (in)	Working Pressure (PSI)	316L Stainless Steel Borosilicate Glass Part #	316 Stainless Steel Polycarbonate Part #
1"	5.625	3.250	145	B54BMP-R100	B54BMP-R100LX
1-1/2"	5.625	4.000	145	B54BMP-R150	B54BMP-R150LX
2"	5.625	4.250	145	B54BMP-R200	B54BMP-R200LX
2-1/2"	6.125	4.750	120	B54BMP-R250	B54BMP-R250LX
3"	7.250	5.500	120	B54BMP-R300	B54BMP-R300LX
4"	7.375	6.500	95	B54BMP-R400	B54BMP-R400LX
6"	7.625	9.500	80	B54BMP-R600	B54BMP-R600LX

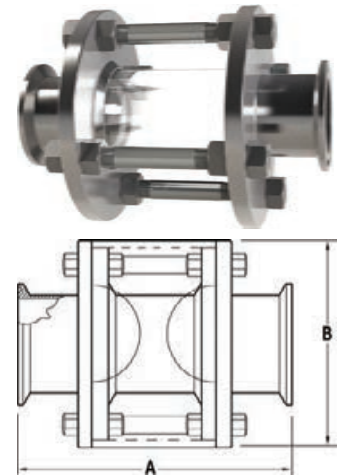

### Kits and Replacement Parts

Size	Nitrile Rubber Seal Kit Part #	FKM Seal Kit Part #	Borosilicate Glass Replacement Part #	Polycarbonate Replacement Part #
1"	B54BMP-SK100	B54BMP-VK100	B54G-P100	B54BMP-LX100
1-1/2"	B54BMP-SK150	B54BMP-VK150	B54G-P150	B54BMP-LX150
2"	B54BMP-SK200	B54BMP-VK200	B54G-P200	B54BMP-LX200
2-1/2"	B54BMP-SK250	B54BMP-VK250	B54G-P250	B54BMP-LX250
3"	B54BMP-SK300	B54BMP-VK300	B54G-P300	B54BMP-LX300
4"	B54BMP-SK400	B54BMP-VK400	B54G-P400	B54BMP-LX400
6"	B54BMP-SK600	B54BMP-VK600	B54G-P600	B54BMP-LX600

NOTE: Seal kit contains: (2) white nitrile rubber gaskets

## Acrylic Sight Glass End Caps - B5416MP

### Feature

- For use on any line with a clamp and gasket

### Specifications

- Maximum temperature: 150°F (66°C)
- Maximum operating pressure: 100 PSI

Tube O.D.	A (in)	B (in)	C (in)	D (in)	Acrylic Plastic Part #
1" - 1-1/2"	1.98	1.72	1.68	.50	B5416MP-A100150
2"	2.52	2.22	2.19	.50	B5416MP-A200
2-1/2"	3.05	2.78	2.71	.50	B5416MP-A250
3"	3.58	3.28	3.22	.50	B5416MP-A300
4"	4.68	4.34	4.26	.50	B5416MP-A400
6"	6.57	6.18	6.13	.50	B5416MP-A600
8"	8.57	8.17	8.22	.50	B5416MP-A600

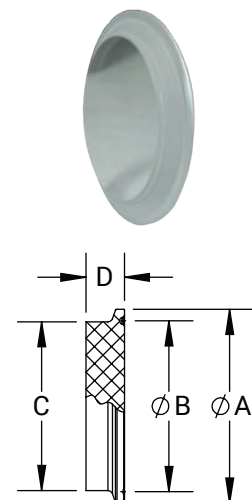

### Compact Sight Glasses - B54BMPS



**Application**

- Used widely in the food, dairy, and beverage sanitary processes to view products and fluids

**Features**

- Design perfect for hoses
- Easier to clean than bolted styles
- Less cost to repair than bolted styles
- Clamp connections standard

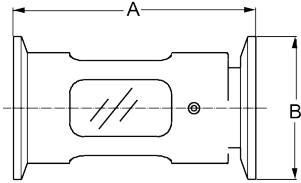

Tube O.D.	Dimensions		316 Stainless Steel Polycarbonate Part #	316 Stainless Steel Borosilicate Glass Part #
	A (in)	B (in)		
1"	3.375	1.985	B54BMPLX-R100	B54BMPS-R100
1-1/2"	3.640	1.985	B54BMPLX-R150	B54BMPS-R150
2"	3.830	2.516	B54BMPLX-R200	B54BMPS-R200
3"	4.130	3.579	B54BMPLX-R300	B54BMPS-R300
4"	4.340	4.682	B54BMPLX-R400	B54BMPS-R400

#### Seal Kits



Size	Nitrile Rubber Seal Kit Part #	FKM Seal Kit Part #
1"	B54BMP-SK100	B54BMP-VK100
1-1/2"	B54BMP-SK150	B54BMP-VK150
2"	B54BMP-SK200	B54BMP-VK200
3"	B54BMP-SK300	B54BMP-VK300
4"	B54BMP-SK400	B54BMP-VK400

#### Replacement Glasses



Size	Polycarbonate Replacement Part #	Borosilicate Glass Replacement Part #
1"	B54BMPS-LX100	B54BMPS-GL100
1-1/2"	B54BMPS-LX150	B54BMPS-GL150
2"	B54BMPS-LX200	B54BMPS-GL200
3"	B54BMPS-LX300	B54BMPS-GL300
4"	B54BMPS-LX400	B54BMPS-GL400

M

## HSG Hygienic Sight Glasses

### Applications

- Used widely in the food, dairy, and beverage sanitary processes to view products and fluids
- Can be used in industrial applications when you want to CIP and require 316L stainless steel construction

### Sizes

- 1/2" to 6"
  - single pin clamp: 1" to 6"; EPDM or FKM gasket
  - bolted clamp: 1/2" to 6"; PTFE gasket

### Features

- 3A CIP certified
- Higher pressure range than other sight glasses
- Easy assembly and disassembly
- Rubber seals are I-line gaskets
- Clamp protects glass from getting damaged
- Patent-pending assembly design



### Materials

- Body: 316L stainless steel
- Sight glass: polycarbonate
- Gaskets: PTFE, EPDM, or FKM



Single Pin Clamp



Bolted Clamp

Tube O.D.	PSI @ 70°F (21°C)	PSI @ 200°F (94°C)	316L Stainless Steel EPDM Seal Part #	316L Stainless Steel FKM Seal Part #	316L Stainless Steel PTFE Seal Part #
1/2"	500	300	---	---	HSGP050CCA
3/4"	500	300	---	---	HSGP075CCA
1"	500	300	HSGE100CCA	HSGV100CCA	HSGP100CCA
1-1/2"	450	250	HSGE150CCA	HSGV150CCA	HSGP150CCA
2"	400	200	HSGE200CCA	HSGV200CCA	HSGP200CCA
2-1/2"	350	175	HSGE250CCA	HSGV250CCA	HSGP250CCA
3"	250	125	HSGE300CCA	HSGV300CCA	HSGP300CCA
4"	80	40	HSGE400CCA	HSGV400CCA	HSGP400CCA
6"	50	25	HSGE600CCA	HSGV600CCA	HSGP600CCA

### Seal Kits

Tube O.D.	EPDM Seal Kit Part #	FKM Seal Kit Part #	PTFE Seal Kit Part #
1/2"	---	---	HSG-RKP050
3/4"	---	---	HSG-RKP075
1"	HSG-RKE100	HSG-RKV100	HSG-RKP100
1-1/2"	HSG-RKE150	HSG-RKV150	HSG-RKP150
2"	HSG-RKE200	HSG-RKV200	HSG-RKP200
2-1/2"	HSG-RKE250	HSG-RKV250	HSG-RKP250
3"	HSG-RKE300	HSG-RKV300	HSG-RKP300
4"	HSG-RKE400	HSG-RKV400	HSG-RKP400
6"	HSG-RKE600	HSG-RKV600	HSG-RKP600

### Replacement Polycarbonate Sight Glass

Tube O.D.	Polycarbonate Part #
1/2"	HSG-POLY-050
3/4"	HSG-POLY-075
1"	HSG-POLY-100
1-1/2"	HSG-POLY-150
2"	HSG-POLY-200
2-1/2"	HSG-POLY-250
3"	HSG-POLY-300
4"	HSG-POLY-400
6"	HSG-POLY-600



### SJSS Series Sanitary Swivels



**Application**

- Process lines that need flexibility to prevent hoses from kinking or making a flow path change on a flow plate

**Sizes**

- 1" - 4"

**Features**

- New and improved design
- Available in clamp and weld configurations in styles 20-70

**Materials**

- Body: 316L stainless steel
- Elastomers: silicone or EPDM

**Approval**

- 3A certified COP

**Straight Clamp - Style 20**

Size	Dimensions			Pressure Rating PSI @ 70°F (21°C)	Pressure Rating PSI @ 250°F (121°C)	316L Stainless Steel Part #
	A (in)	B (in)	C (in)			
1"	2.42	3.86	1.00	500	300	SJSS100*CC120
1-1/2"	2.99	3.87	1.50	500	300	SJSS150*CC120
2"	3.48	3.84	2.00	450	250	SJSS200*CC120
2-1/2"	3.98	3.84	2.50	400	200	SJSS250*CC120
3"	5.08	3.84	3.00	350	175	SJSS300*CC120
4"	7.03	4.97	4.00	300	150	SJSS400*CC120

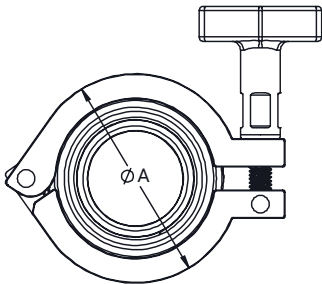

**Straight Weld Connection - Style 20**

Size	Dimensions			Pressure Rating PSI @ 70°F (21°C)	Pressure Rating PSI @ 250°F (121°C)	316L Stainless Steel Part #
	A (in)	B (in)	C (in)			
1"	2.42	2.24	1.00	500	300	SJSS100*BB120
1-1/2"	2.99	2.24	1.50	500	300	SJSS150*BB120
2"	3.48	2.22	2.00	450	250	SJSS200*BB120
2-1/2"	3.98	2.22	2.50	400	200	SJSS250*BB120
3"	5.08	2.21	3.00	350	175	SJSS300*BB120
4"	7.03	3.22	4.00	300	150	SJSS400*BB120

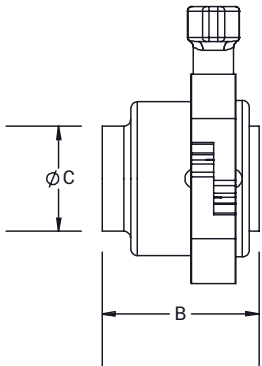

NOTE: S=Silicone  
NOTE: E=EPDM

M

**Repair Kits**

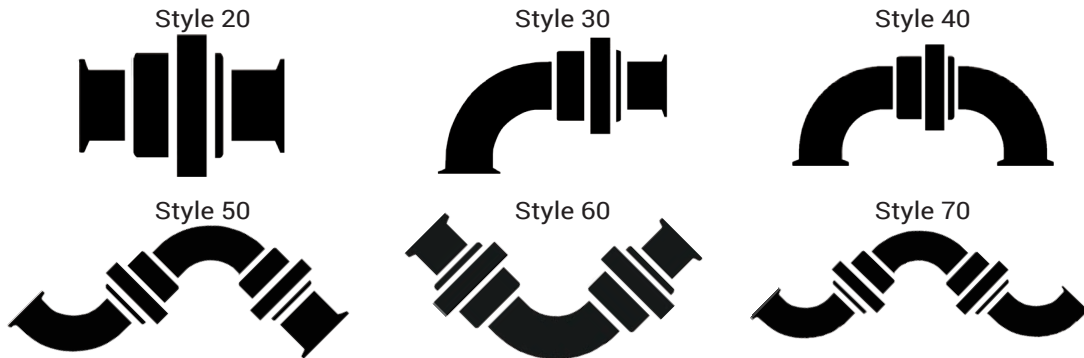

Size	Contains	Silicone Part #	EPDM Part #
1"		SJSS-REPAR-S100	SJSS-REPAR-E100
1-1/2"	(1x) Inner Body Gasket (1x) Outer Body Gasket (1x) Upper Body Seat (1x) Lower Body Washer	SJSS-REPAR-S150	SJSS-REPAR-E150
2"		SJSS-REPAR-S200	SJSS-REPAR-E200
2-1/2"		SJSS-REPAR-S250	SJSS-REPAR-E250
3"		SJSS-REPAR-S300	SJSS-REPAR-E300
4"		SJSS-REPAR-S400	SJSS-REPAR-E400



## FH-SC-Series Sanitary Cartridge Filter Element Housings

### Sizes

- Port connection: 1" - 4"
- Number of elements: 1, 3, 5, 7, 12, and 21
- Cartridge element lengths: 10", 20", 30", and 40"

### Features

- Single-cartridge element housings utilize a heavy-duty stainless steel clamp closure for ease of element changes
- Multiple cartridge element housings feature a swing bolt closure to ensure positive sealing
- High purity construction assures dependable protection for critical process applications
- Custom OEM designs available
- Large variety of cartridge elements available to meet your application needs

### Materials

- Product contact: 316L stainless steel
- Non-contact: 304 stainless steel
- 32Ra, O.D. polish; 25Ra I.D. polish
- Silicone O-ring seals standard; FKM and EPDM optional

### Specifications

- 150 PSI working pressure at 300°F (149°C)
- 1-1/2" clamp vent/gauge connection standard
- 1/2" clamp drain connection standard
- 222 or 226 cartridge elements
- Clamp connections standard; for optional connections call Dixon Sanitary at 800.789.1718.



# of Elements	Element Length (in)	Element Type	Connection Size (in)	Connections Type	Seal Material	Part #
1	10	222	1	clamp	silicone	FH-SC110A10CS
1	20	222	1	clamp	silicone	FH-SC120A10CS
1	30	222	1	clamp	silicone	FH-SC130A10CS
3	30	222	2	clamp	silicone	FH-SC330A20CS
5	30	222	2	clamp	silicone	FH-SC530A20CS
7	30	222	2	clamp	silicone	FH-SC730A20CS
12	30	222	3	clamp	silicone	FH-SC1230A30CS
1	10	226	1	clamp	silicone	FH-SC110B10CS
1	20	226	1	clamp	silicone	FH-SC120B10CS
1	30	226	1	clamp	silicone	FH-SC130B10CS
3	30	226	2	clamp	silicone	FH-SC330B20CS
5	30	226	2	clamp	silicone	FH-SC530B20CS
7	30	226	2	clamp	silicone	FH-SC730B20CS
12	30	226	3	clamp	silicone	FH-SC1230B30CS

NOTE: Filter elements are not included with the filter housings and must be ordered separately.



## DF-MB-Series Melt Blown Cartridge Filters

### Sizes

- Diameters: 2-1/2" (standard) to 4-1/2"
- Cartridge element lengths: 9-3/4" to 50"

### Features

- Made in the USA
- FDA title 21 compliant
- No glue or binders
- Low pressure drop
- 4 zone technology within cartridge allows for high dirt loading
- Available in industry standard end connections
- Multiple efficiency options available
  - Pro - 90%
  - Deluxe - 95%
  - Elite - 99%
- RO - reverse osmosis applications
- Most combinations are WQA tested and certified to:
  - NSF / ANSI 372
  - NSF / ANSI 61
  - CSA B483.1
  - NSF / ANSI 42 - Component

### Materials

- Cartridge element: polypropylene
- Gasket/O-ring: nitrile rubber, FKM, PTFE, silicone, neoprene, EPDM, and Polyfoam; no selection required for double open-ended (DOE) cartridge elements

### Specifications

- Maximum differential pressure:
  - 40 PSID (2.7 bar) at 155°F (68°C)**
  - 60 PSID (4.1 bar) at 86°F (30°C)**
- Recommended change out differential pressure:
  - with core **35 PSID (2.4 bar)**
  - without core **20 PSID (1.3 bar)**
- Micron ratings: 1, 5, 10, 20, 25, 30, 75, and 100
- Sold in standard case quantities only
  - 10" and under are 30 pcs/case
  - 19-1/2" thru 30" are 15 pcs/case
  - 39" and above are determined at time of quote
  - Custom lengths are determined at time of quote

Element Length	Style	Micron	Materials	Case Qty	Part #
10"	DOE / 4-Zone	1	polypropylene	30	DF-MBS1C21
10"	DOE / 4-Zone	10	polypropylene	30	DF-MBS10C21
10"	DOE / 4-Zone	50	polypropylene	30	DF-MBS50C21
10"	DOE / 4-Zone	100	polypropylene	30	DF-MBS100C21
20"	DOE / 4-Zone	1	polypropylene	15	DF-MBS1E21
20"	DOE / 4-Zone	10	polypropylene	15	DF-MBS10E21
20"	DOE / 4-Zone	50	polypropylene	15	DF-MBS50E21
20"	DOE / 4-Zone	100	polypropylene	15	DF-MBS100E21
30"	DOE / 4-Zone	1	polypropylene	15	DF-MBS1G21
30"	DOE / 4-Zone	10	polypropylene	15	DF-MBS10G21
30"	DOE / 4-Zone	50	polypropylene	15	DF-MBS50G21
30"	DOE / 4-Zone	100	polypropylene	15	DF-MBS100G21

## DF-PES-Series Cartridge Filters



## Sizes

- Diameters: 2.65" O.D.; 1" center I.D.
- Cartridge element lengths: 10" to 40"

## Features

- FDA title 21 compliant
- Cartridge elements are constructed in a clean room environment
- Cartridge elements have excellent dirt holding capacity with low flow resistance
- Cartridge elements are free of surfactants, resins, binders, and adhesives
- Low protein binding and chemical compatibility
- Naturally hydrophilic media does not need wetting before use

## Materials

- Cartridge element: polyethersulfone
- Core material: polypropylene
- Gasket/O-ring: nitrile rubber, FKM, PTFE, silicone, neoprene, and EPDM

## Specifications

- Maximum differential pressure: **45 PSID** (3.1 bar)
- Maximum operating pressure: **45 PSID** (3.1 bar)
- Maximum operating temperature: **180°F (82°C)**
- Micron ratings: .1, .22, .45, .60, .80, 1.2, and 5.0
- Sold in standard case quantities only, all sizes are 6 pcs/case



Element Length	Style	Micron	Material	Case Qty	Part #
10"	hard cage/222/closed	.22	polyethersulfone/ polypropylene/silicone	6	DF-PES.22CE4S
10"	hard cage/222/closed	.45	polyethersulfone/ polypropylene/silicone	6	DF-PES.45CE4S
20"	hard cage/222/closed	.22	polyethersulfone/ polypropylene/silicone	6	DF-PES.22EE4S
20"	hard cage/222/closed	.45	polyethersulfone/ polypropylene/silicone	6	DF-PES.45EE4S
30"	hard cage/222/closed	.22	polyethersulfone/ polypropylene/silicone	6	DF-PES.22GE4S
30"	hard cage/222/closed	.45	polyethersulfone/ polypropylene/silicone	6	DF-PES.45GE4S
10"	hard cage/226/fin	.22	polyethersulfone/ polypropylene/silicone	6	DF-PES.22CE5S
10"	hard cage/226/fin	.45	polyethersulfone/ polypropylene/silicone	6	DF-PES.45CE5S
20"	hard cage/226/fin	.22	polyethersulfone/ polypropylene/silicone	6	DF-PES.22EE5S
20"	hard cage/226/fin	.45	polyethersulfone/ polypropylene/silicone	6	DF-PES.45EE5S
30"	hard cage/226/fin	.22	polyethersulfone/ polypropylene/silicone	6	DF-PES.22GE5S
30"	hard cage/226/fin	.45	polyethersulfone/ polypropylene/silicone	6	DF-PES.45GE5S

M

## DF-PHE-Series Pleated High-Efficiency Cartridge Filters

**Sizes**

- Diameters: 2.65"
- Cartridge element lengths: 9-3/4" to 40"

**Features**

- FDA title 21 compliant
- Cartridge elements are constructed in a clean room environment
- Cartridge elements are free of surfactants, resins, binders, and adhesives

**Materials**

- Cartridge element: polypropylene
- Gasket/O-ring: nitrile rubber, FKM, PTFE, silicone, neoprene, and EPDM

**Specifications**

- Maximum operating pressure: **35 PSID** (2.4 bar)
- Recommended change out differential pressure: **35 PSID** (2.4 bar)
- Maximum operating temperature: **180°F (82°C)**
- Retention rating of 99.98%
- Micron ratings: .2, .45, 1, 3, 5, 10, 25, and 50
- Available in hard cage (standard) or netted cage
- Sold in standard case quantities only, all sizes are 6 pcs/case

Element Length	Style	Micron	Material	Case Qty	Part #
10"	hard cage/doe/gasket	.45	polypropylene/silicone	6	DF-PHB.45C1E9S
10"	hard cage/doe/gasket	1	polypropylene/silicone	6	DF-PHB1CE9S
20"	hard cage/doe/gasket	.45	polypropylene/silicone	6	DF-PHB.45E1E9S
20"	hard cage/doe/gasket	1	polypropylene/silicone	6	DF-PHB1E1E9S
30"	hard cage/doe/gasket	.45	polypropylene/silicone	6	DF-PHB.45G1E9S
30"	hard cage/doe/gasket	1	polypropylene/silicone	6	DF-PHB1G1E9S
10"	hard cage/222/closed	.45	polypropylene/silicone	6	DF-PHB.45C1E4S
10"	hard cage/222/closed	1	polypropylene/silicone	6	DF-PHB1CE4S
20"	hard cage/222/closed	.45	polypropylene/silicone	6	DF-PHB.45E1E4S
20"	hard cage/222/closed	1	polypropylene/silicone	6	DF-PHB1E1E4S
30"	hard cage/222/closed	.45	polypropylene/silicone	6	DF-PHB.45G1E4S
30"	hard cage/222/closed	1	polypropylene/silicone	6	DF-PHB1G1E4S
10"	hard cage/226/fin	.45	polypropylene/silicone	6	DF-PHB.45C1E6S
10"	hard cage/226/fin	1	polypropylene/silicone	6	DF-PHB1C1E6S
20"	hard cage/226/fin	.45	polypropylene/silicone	6	DF-PHB.45E1E6S
20"	hard cage/226/fin	1	polypropylene/silicone	6	DF-PHB1E1E6S
30"	hard cage/226/fin	.45	polypropylene/silicone	6	DF-PHB.45G1E6S
30"	hard cage/226/fin	1	polypropylene/silicone	6	DF-PHB1G1E6S

## DF-CB-Series Carbon Block Cartridge Filters



### Sizes

- Diameters: 2-1/2" and 4-1/2" O.D.
- Lengths: 9.75" to 40"

### Features

- Made in the USA
- FDA title 21 compliant
- One piece carbon block construction reduces bypassing
- No GAC by-pass or fluidizing
- Consistent density for controlled flow rates and pressure loss
- Reduce foul odors, chlorine taste and, particulate matter
- Proprietary carbon blend formula

### Materials

- Cartridge element: Extruded coconut carbon construction
- End caps: polypropylene and plastisol
- Gasket/O-ring: nitrile rubber, FKM, PTFE, silicone, neoprene, and EPDM

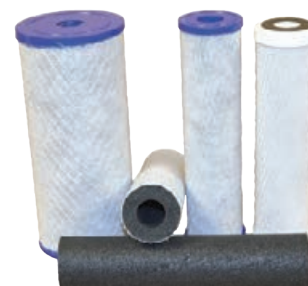

### Specifications

- Micron ratings: 1, 3, 5, and 10
- Recommended differential pressure up to **5 PSID (0.3 bar)**
- Maximum operating temperature: **180°F (82°C)**
- Sold in standard case quantities only
  - 10" are 30 pcs/case
  - 20" and above are 15 pcs/case

Element Length	Micron Rating	Part #
10"	1	DF-CB1C11B
	3	DF-CB3C11B
	5	DF-CB5C11B
	10	DF-CB10C11B
20"	1	DF-CB1E11B
	3	DF-CB3E11B
	5	DF-CB5E11B
	10	DF-CB10E11B
30"	1	DF-CB1G11B
	3	DF-CB3G11B
	5	DF-CB5G11B
	10	DF-CB10G11B
40"	1	DF-CB1I11B
	3	DF-CB3I11B
	5	DF-CB5I11B
	10	DF-CB10I11B

NOTE: Part numbers reflect 2-1/2" diameter, DOE (plastisol ends), and nitrile rubber gaskets.  
For other options, please contact Dixon Sanitary at 800.789.1718..



**Strainers**

**In-line - BSCCQ**



short

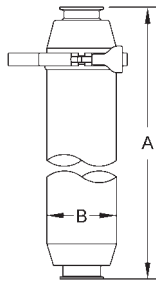

**Features**

- Ships standard with: spring, distributor cap, clamp gasket, 1/4" perforated back-up tube, squeeze clamp, inlet and outlet bodies
- Bevel seat, I-line, and weld ends available, call Dixon Sanitary at 800.789.1718 for information
- 1/8" perforated back-up tube available, must specify when ordering (not 3A)

**Approval**

- Must be vertically mounted to be 3A compliant

**Short**

Size	Dimensions		316L Stainless Steel Part #
	A (in)	B (in)	
1"	15.75"	4.00"	BSCCQ1-R100
1-1/2"	15.75"	4.00"	BSCCQ1-R150
2"	15.75"	4.00"	BSCCQ1-R200
2-1/2"	15.75"	4.50"	BSCCS1-R250
3"	15.75"	4.50"	BSCCS1-R300

**Long**

Size	Dimensions		316L Stainless Steel Part #
	A (in)	B (in)	
1-1/2"	35.375"	4.00"	BSCCQ2-R150
2"	35.375"	4.00"	BSCCQ2-R200
3"	35.375"	4.50"	BSCCS2-R300

**Side-Entry - BSCCQ**

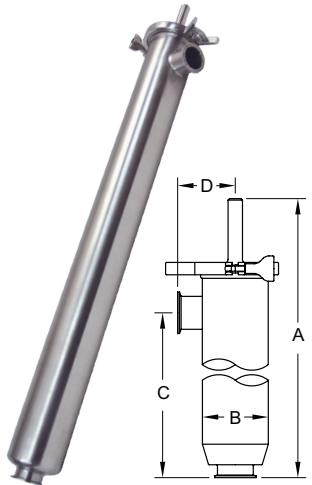

**Features**

- Ships standard with: spring, end cap with handle, distributor cap, clamp gasket, 1/4" perforated back-up tube, body, and squeeze clamp
- Serviceable without removing from the line
- Bevel seat, I-line, and weld ends available; call Dixon for information
- 1/8" perforated back-up tube available, must specify when ordering (not 3A certified)

**Approval**

- Must be a vertically mounted to be 3A compliant

Size	Dimensions				316L Stainless Steel Part #
	A (in)	B (in)	C (in)	D (in)	
1-1/2"	41.90"	4.00"	35.00"	3.50"	BSCCQ3-R150
2"	41.90"	4.00"	35.00"	3.50"	BSCCQ3-R200
3"	41.90"	4.50"	35.00"	3.75"	BSCCQ3-R300

**Side-Outlet Reverse - BSCCQ**

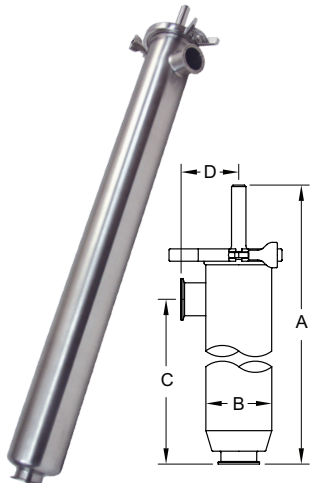

**Features**

- Ships standard with: spring, end cap with handle, distributor cap, clamp gasket, 1/4" perforated back-up tube, body, and squeeze clamp
- 1/8" perforated back-up tube available (not 3A certified)
- Bevel seat, I-line and weld ends available, call Dixon for information
- Can be serviced in-line

Size	Dimensions				316L Stainless Steel Part #
	A (in)	B (in)	C (in)	D (in)	
1-1/2"	41.90"	4.00"	35.00"	3.50"	BSCCQ4-R150
2"	41.90"	4.00"	35.00"	3.50"	BSCCQ4-R200
3"	41.90"	4.50"	35.00"	3.75"	BSCCQ4-R300

M

## Strainers

### Filters

#### Features

- Filter medium are special order and minimum quantities apply, not included with base unit
- Filters require retaining ring

#### Short

Size	Micron Rating	Description	Part #
1" - 2"	38	nonwoven rayon (glued seam)	BF30A-100-200
2-1/2" - 3"	38	nonwoven rayon (glued seam)	BF30A-250-300
1" - 2"	513	woven knapped cotton flannel	BF30B-100-200
2-1/2" - 3"	513	woven knapped cotton flannel	BF30B-250-300
1" - 2"	300	cheese cloth, single thickness cotton	BF30C-100-200
2-1/2" - 3"	300	cheese cloth, single thickness cotton	BF30C-250-300
1" - 2"	765	nylon, 26/29 mesh, rectangular opening, (.025 x .030)	BF30D-100-200
2-1/2" - 3"	765	nylon, 26/29 mesh, rectangular opening, (.025 x .030)	BF30D-250-300
1" - 2"	40-42	nonwoven rayon	BF30E-100-200
2-1/2" - 3"	40-42	nonwoven rayon	BF30E-250-300
1" - 2"	40	nonwoven rayon	---
1" - 2"	420	woven nylon, 40 mesh	BF30G-100-200
2-1/2" - 3"	420	woven nylon, 40 mesh	BF30G-250-300

#### Long

Size	Micron Rating	Description	Part #
1" - 2"	40-42	nonwoven rayon	BF302E-100-200
2-1/2" - 3"	40-42	nonwoven rayon	BF302E-250-300
2-1/2" - 3"	420	woven nylon, 40 mesh	BF302G-250-300

**M**

## Strainers

### 316 Stainless Wire Cloth Mesh Over Screens

**Features**

- Not all sizes are stocked, additional sizes are available (five piece minimum); call Dixon Sanitary at 800.789.1718.
- Not 3A compatible; not included with base unit

Size	Micron Rating	Square Mesh	Space Between Wires	Percent of Open Area	Short Part #	Long Part #
1" - 2"	864	20	0.034"	46.2	BS20-100-200	BS202-100-200
2-1/2" - 3"					BS20-250-300	BS202-250-300
1" - 2"	381	40	0.015"	36.0	BS40-100-200	BS402-100-200
2-1/2" - 3"					BS40-250-300	BS402-250-300
1" - 2"	229	60	0.009"	30.3	BS60-100-200	BS602-100-200
2-1/2" - 3"					BS60-250-300	BS602-250-300
1" - 2"	178	80	0.007"	31.4	BS80-100-200	BS802-100-200
2-1/2" - 3"					BS80-250-300	BS802-250-300
1" - 2"	140	100	0.006"	30.3	BS100-100-200	BS1002-100-200
2-1/2" - 3"					BS100-250-300	BS1002-250-300

### Pressure Drop Curves for Filter and Strainer

**Specifications**

- Water at ambient temperature:  
 Maximum flow for short units is **125 GPM**  
 Maximum flow for long units is **175 GPM**

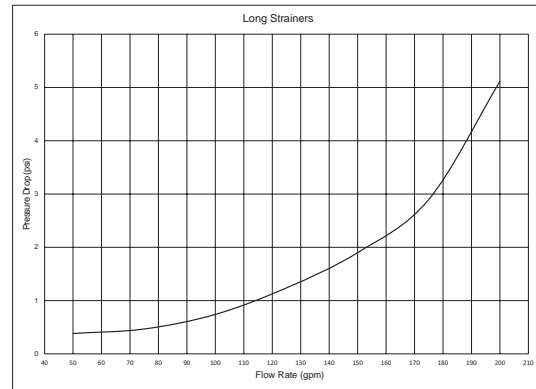
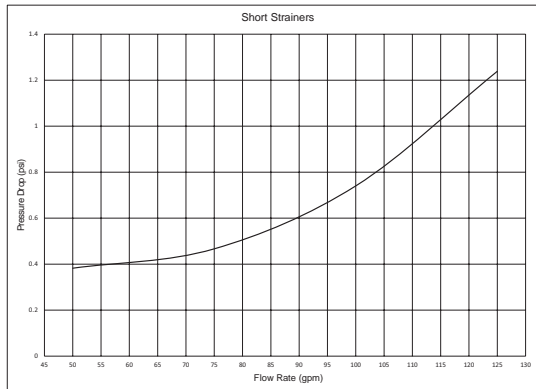



## DX60-Series Hygienic Tanker Valves



### Applications

- Used on food-grade stainless steel bulk transport trailers to safely and hygienically load and unload various products including milk, juices, chocolate, glycerin, and many types of food-grade oils

### Size

- 3"

### Features

- Valve housing machined from solid bar
- Hygienic single-acting wiper seal improves cleanability and durability
- Easy-lock plunger for locking valve in open position
- Patent-pending closure system to eliminate the pinch point
- Bonnet design uses standard sanitary clamp for easy removal

### Materials

- Valve: 304 stainless steel
- Seals: FKM or nitrile rubber
- Cover: aluminum

### Specifications

- Holding pressure: **75 PSI**
- Surface I.D. finish: <32Ra
- Connections: flange x male threaded bevel
- Temperature range: -20°F to 212°F (-28.9°C to 100°C)

### Approval

- 3A-Authorization Number 1655, 53-06 (Compression-Type Valves) for CIP and COP



Size	Cover Style	Part #
3"	with aluminum cover	DX603010A1GV1
	without aluminum cover	DX603010A1GV2

NOTE: All part numbers include 3", L body style, flange to trailer x male threaded bevel, 304 stainless steel construction, standard rod, and FKM gaskets.  
For other configurations, contact Dixon Sanitary at 800.789.1718



### Valve Body Style Port Configurations

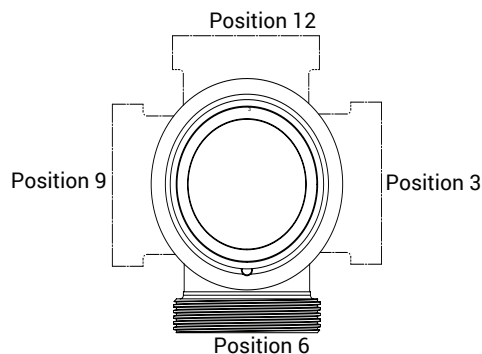

## 2-Way, 3-Piece Encapsulated Ball Valves

### Features

- Live-loaded stem packing
- Precision stainless steel balls reduce torque and friction losses while extending seat life
- Integral ISO 5211 mounting pad
- I.D. polish is Ra 32 minimum
- Lockable handle can prevent accidental actuation
- Standard internal entry blowout-proof stem design
- Full port design matches ball and seat ports to tube I.D. for lower pressure drop and less turbulent flow
- Compact design for areas with tight space restrictions
- Fully encapsulated construction produces bubble tight seal
- Identification tagging available
- Balanced encapsulated construction minimizes cold flow



### Materials

- Body, ends, and ball: CF8M stainless
- Seats: virgin PTFE, 15% glass reinforced RTFE, 25% carbon reinforced PTFE, 50% stainless steel reinforced PTFE or UHMW

### Specifications

- Maximum pressure rating: 1/2" - 2" **1000 PSI WOG**, 2-1/2" - 4" **800 PSI WOG**
- For valve seat options, call Dixon Sanitary at 800.789.1718
- Repair kits available

M

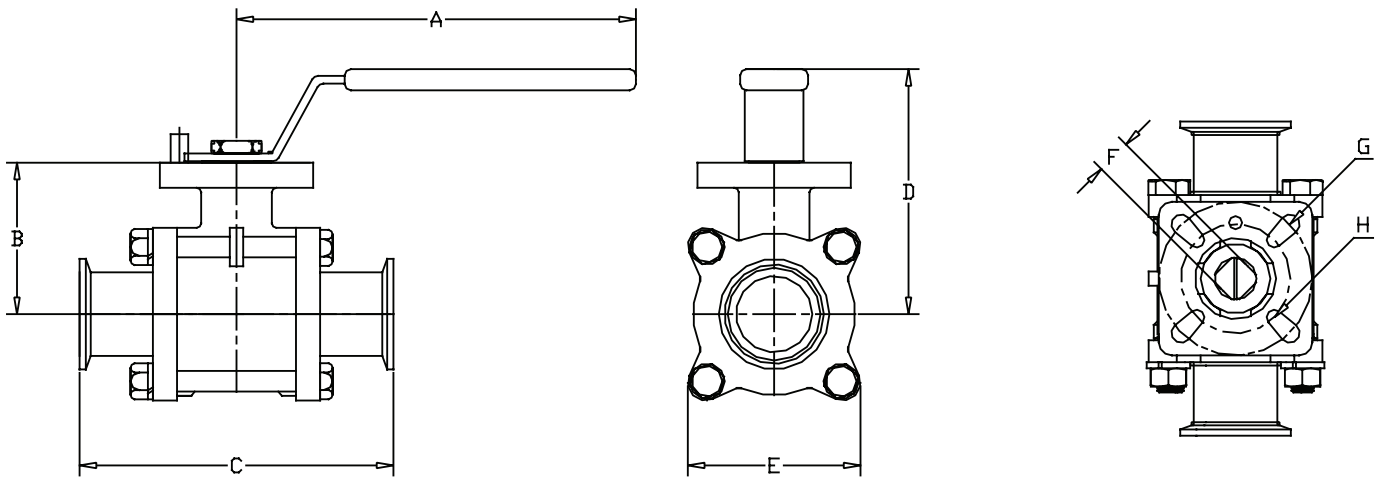

Size	Dimensions								316 Stainless Steel Part #
	A (in)	B (in)	C (in)	D (in)	E (in)	F (mm)	G (mm)	H (mm)	
1/2"	4.9	1.5	4.3	3.1	2.0	9	42	36	BV2CV-050CC-A
3/4"	4.9	1.8	4.7	3.4	2.2	9	42	36	BV2CV-075CC-A
1"	5.4	2.1	4.9	3.6	2.4	11	50	42	BV2CV-100CC-A
1-1/2"	9.3	2.7	5.6	4.4	3.2	14	70	50	BV2CV-150CC-A
2"	9.3	3.1	6.4	4.7	3.8	14	70	50	BV2CV-200CC-A
2-1/2"	18.0	3.8	7.8	5.2	4.9	17	102	70	BV2CV-250CC-A
3"	18.3	4.2	9.0	5.7	5.4	17	102	70	BV2CV-300CC-A
4"	18.3	5.3	9.6	6.9	8.7	22	125	102	BV2CV-400CC-A

## Non-Encapsulated 2-Way, 3-Piece Stainless Steel Ball Valves

### Features

- Blowout-proof stem
- Live-loaded stem packing
- I.D. polish is Ra 32
- Lockable handle

### Materials

- Body, ends, and ball: CF8M stainless
- Seats: 15% glass reinforced PTFE

### Specifications

- Maximum pressure rating: 1/2" - 2" **1000 PSI WOG**, 2-1/2" - 4" **800 PSI WOG**
- Maximum temperature: **300°F (149°C)**
- Repair kits available

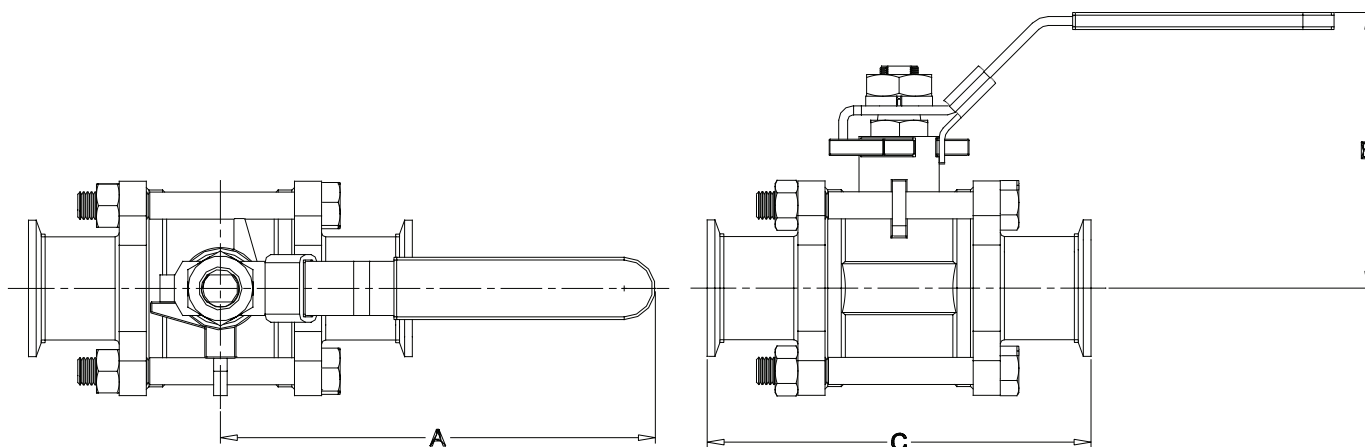
**M**

Size	Dimensions			316 Stainless Steel Part #
	A (in)	B (in)	C (in)	
1/2"	4.1	2.3	4.6	BV2GG-050CC-A
3/4"	4.1	2.5	4.7	BV2GG-075CC-A
1"	5.0	2.8	4.9	BV2GG-100CC-A
1-1/2"	6.1	3.5	5.6	BV2GG-150CC-A
2"	7.6	3.9	6.4	BV2GG-200CC-A
2-1/2"	7.6	4.4	7.8	BV2GG-250CC-A
3"	10.9	4.9	9.0	BV2GG-300CC-A
4"	13.2	6.6	9.6	BV2GG-400CC-A

NOTE: Dimensions are approximate. Engineering dimensions are available upon request. Specifications are subject to change without notice.

## Butterfly Valves - B5107

### Features

- Low resistance to flow
- Bi-directions flow
- Gentle to media
- Suitable for low and medium viscosity fluids
- Can be serviced in the field
- Self-draining
- Various manual or automatic operators available; call Dixon Sanitary for details 800.789.1718
- Optional wing nut kit is available for easy assembly and disassembly
- 100% hydraulic tested / 100% inspected

### Materials

- Body and disc: 316L
- Seat: EPDM, FKM, (6" EPDM and silicone, 8" EPDM only)

### Specifications

- Vacuum rating: 0.4 inches Hg at 68°F (20°C)
- Operating temperature range: 15°F to 200°F (-9°C to 93°C)

### Clamp End with Pull Handle - [A]

Size	316L Stainless Steel with Silicone Seats Part #	316L Stainless Steel with FKM Seats Part #	316L Stainless Steel with EPDM Seats Part #
1/2"	B5107S050CC-A	B5107V050CC-A	B5107E050CC-A
3/4"	B5107S075CC-A	B5107V075CC-A	B5107E075CC-A
1"	B5107S100CC-A	B5107V100CC-A	B5107E100CC-A
1-1/2"	B5107S150CC-A	B5107V150CC-A	B5107E150CC-A
2"	B5107S200CC-A	B5107V200CC-A	B5107E200CC-A
2-1/2"	B5107S250CC-A	B5107V250CC-A	B5107E250CC-A
3"	B5107S300CC-A	B5107V300CC-A	B5107E300CC-A
4"	B5107S400CC-A	B5107V400CC-A	B5107E400CC-A
6"	B5107S600CC-A	---	B5107E600CC-A
8"	---	---	B5107E800CC-A

NOTE: 4" high-pressure butterfly valve is available; call Dixon Sanitary at 800.789.1718 for more information

Size	Dimensions				
	A (in)	B (in)	C (in)	D (in)	E (in)
1/2"	3.50	.90	3.10	2.60	4.60
3/4"	3.50	.90	3.10	2.60	4.60
1"	3.50	.90	3.10	2.60	4.60
1-1/2"	3.50	.90	3.10	2.60	4.60
2"	3.80	.90	3.90	3.00	4.60
2-1/2"	3.80	.90	4.60	3.40	4.60
3"	4.10	1.20	5.20	3.50	6.50
4"	4.80	1.20	6.70	4.30	6.50
6"	5.50	1.20	8.50	5.60	11.70
8"	5.00	1.20	11.20	7.80	18.10

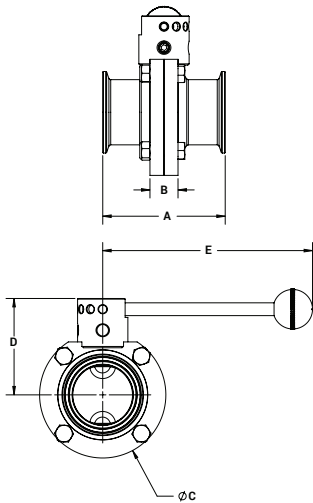

M

## Butterfly Valves - B5107

### Clamp End with Infinite Position Handle - [B]

Size	316L Stainless Steel with Silicone Seats Part #	316L Stainless Steel with FKM Seats Part #	316L Stainless Steel with EPDM Seats Part #
1/2"	B5107S050CC-B	B5107V050CC-B	B5107E050CC-B
3/4"	B5107S075CC-B	B5107V075CC-B	B5107E075CC-B
1"	B5107S100CC-B	B5107V100CC-B	B5107E100CC-B
1-1/2"	B5107S150CC-B	B5107V150CC-B	B5107E150CC-B
2"	B5107S200CC-B	B5107V200CC-B	B5107E200CC-B
2-1/2"	B5107S250CC-B	B5107V250CC-B	B5107E250CC-B
3"	B5107S300CC-B	B5107V300CC-B	B5107E300CC-B
4"	B5107S400CC-B	B5107V400CC-B	B5107E400CC-B

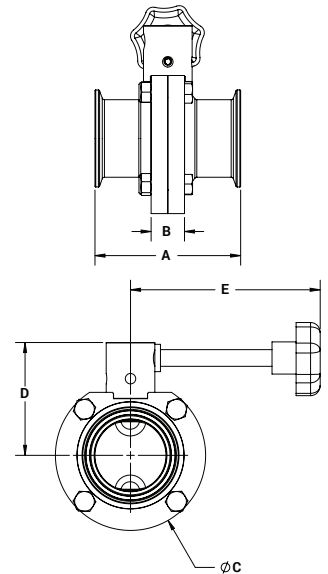

Size	Dimensions				
	A (in)	B (in)	C (in)	D (in)	E (in)
1/2"	3.50	.90	3.10	2.60	4.90
3/4"	3.50	.90	3.10	2.60	4.90
1"	3.50	.90	3.10	2.60	4.90
1-1/2"	3.50	.90	3.10	2.60	4.90
2"	3.80	.90	3.90	3.00	4.90
2-1/2"	3.80	.90	4.60	3.40	4.90
3"	4.10	1.20	5.20	3.50	6.60
4"	4.80	1.20	6.70	4.30	6.60

**M**

## Butterfly Valves - B5107

### Clamp End with Trigger Handle - [C]

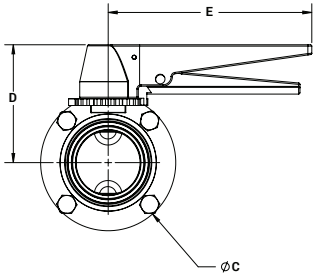
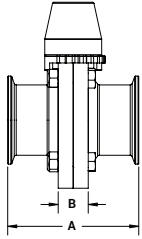

Size	316L Stainless Steel with Silicone Seats Part #	316L Stainless Steel with FKM Seats Part #	316L Stainless Steel with EPDM Seats Part #
1/2"	B5107S050CC-C	B5107V050CC-C	B5107E050CC-C
3/4"	B5107S075CC-C	B5107V075CC-C	B5107E075CC-C
1"	B5107S100CC-C	B5107V100CC-C	B5107E100CC-C
1-1/2"	B5107S150CC-C	B5107V150CC-C	B5107E150CC-C
2"	B5107S200CC-C	B5107V200CC-C	B5107E200CC-C
2-1/2"	B5107S250CC-C	B5107V250CC-C	B5107E250CC-C
3"	B5107S300CC-C	B5107V300CC-C	B5107E300CC-C
4"	B5107S400CC-C	B5107V400CC-C	B5107E400CC-C

Size	Dimensions				
	A (in)	B (in)	C (in)	D (in)	E (in)
1/2"	3.50	.90	3.10	2.60	5.90
3/4"	3.50	.90	3.10	2.60	5.90
1"	3.50	.90	3.10	2.60	5.90
1-1/2"	3.50	.90	3.10	2.60	5.90
2"	3.80	.90	3.90	3.00	5.90
2-1/2"	3.80	.90	4.60	3.40	5.90
3"	4.10	1.20	5.20	3.50	5.90
4"	4.80	1.20	6.70	4.30	5.90

### Repair Kits for Butterfly Valves

#### Features

- Repair kit contains:
  - (1) seat
  - (2) bushings
- For valves located on pages 739 - 740



Valve Size	Black EPDM Part #	Red Silicone Part #	Brown FKM Part #
1/2" - 1"	B5107-RKE100	B5107-RKS100	B5107-RKV100
1-1/2"	B5107-RKE150	B5107-RKS150	B5107-RKV150
2"	B5107-RKE200	B5107-RKS200	B5107-RKV200
2-1/2"	B5107-RKE250	B5107-RKS250	B5107-RKV250
3"	B5107-RKE300	B5107-RKS300	B5107-RKV300
4"	B5107-RKE400	B5107-RKS400	B5107-RKV400
6"	B5107-RKE600	B5107-RKS600	---
8"	B5107-RKE800	---	---

M

## Butterfly Valves - B5102

### Clamp

#### Features

- All sizes use only 3/4" of line space
- The grooved clamp housing connects directly to the corresponding sanitary clamp size
- PTFE valve disc bushings reduce friction and increase cycle life
- 3-position reversible handle
- 100% tested / 100% inspected
- Can be serviced in field (no special tools required)
- Can be modified for lockout / tagout
- Various automated options available

#### Materials

- Contact product surfaces: sanitary finish 316L stainless steel
- Seat: silicone, EPDM, FKM

#### Specifications

- Vacuum rating: 0.4 inches Hg @ 68°F (20°C)
- Operating temperature range: 15°F to 200°F (-9°C to 93°C)

Information supplied based on water media @ 68°F (20°C)

Size	Break Torque (in. lbs.)	Assembly Torque (in. lbs.)	Pressure Rating (PSI)	Flow Coefficient (C <sub>v</sub> )	Weight w/standard handle (lbs.)
1"	125	36	140	23	1.5
1-1/2"	185	36	140	80	2
2"	200	21.6	120	230	2.5
2-1/2"	260	21.6	120	264	3
3"	350	28.8	100	372	4
4"	495	43.2	70	800	6

Size	316L Stainless Steel with Silicone Seats Part #	316L Stainless Steel with FKM Seats Part #	316L Stainless Steel with EPDM Seats Part #
1"	B5102S100-A	B5102V100-A	B5102E100-A
1-1/2"	B5102S150-A	B5102V150-A	B5102E150-A
2"	B5102S200-A	B5102V200-A	B5102E200-A
2-1/2"	B5102S250-A	B5102V250-A	B5102E250-A
3"	B5102S300-A	B5102V300-A	B5102E300-A
4"	B5102S400-A	B5102V400-A	B5102E400-A



M

Size	Dimensions						PSI @ 68°F (20°C)
	A (in)	B (in)	C (in)	D (in)	E (in)	F (in)	
1"	5.6	2.8	1.3	1.3	3.6	5.6	140
1-1/2"	5.6	2.8	1.3	1.3	3.6	5.6	140
2"	5.6	3.0	1.3	1.3	4.1	6.1	120
2-1/2"	5.6	3.3	1.3	1.3	4.6	6.6	120
3"	5.6	3.6	1.3	1.3	5.3	7.1	100
4"	5.6	4.1	1.3	1.3	6.4	8.2	70

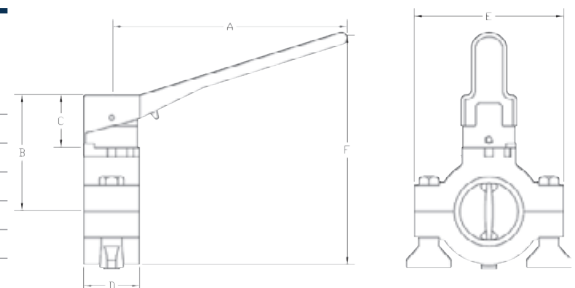

#### Repair Kits for Clamp Butterfly Valves

#### Feature

- Repair kit contains
  - (1) seat
  - (2) bushings

Valve Size	Black EPDM Part #	Red Silicone Part #	Brown FKM Part #
1"	B5102-RKE100	B5102-RKS100	B5102-RKV100
1-1/2"	B5102-RKE150	B5102-RKS150	B5102-RKV150
2"	B5102-RKE200	B5102-RKS200	B5102-RKV200
2-1/2"	B5102-RKE250	B5102-RKS250	B5102-RKV250
3"	B5102-RKE300	B5102-RKS300	B5102-RKV300
4"	B5102-RKE400	B5102-RKS400	B5102-RKV400



B5102-RKS100

## B5116-Series - 304 Stainless Steel Butterfly Valves

### Features

- Manual operation only; cannot be actuated
- Product contact are sanitary finish to <math><32Ra</math>
- Can be serviced in field
- Blue trigger handle

### Material

- Silicone seats

### Specifications

- Operating temperature range: 15°F to 200°F (-9°C to 93°C)
- Maximum operating pressure: 110 PSI

#### Clamp End with Trigger Handle

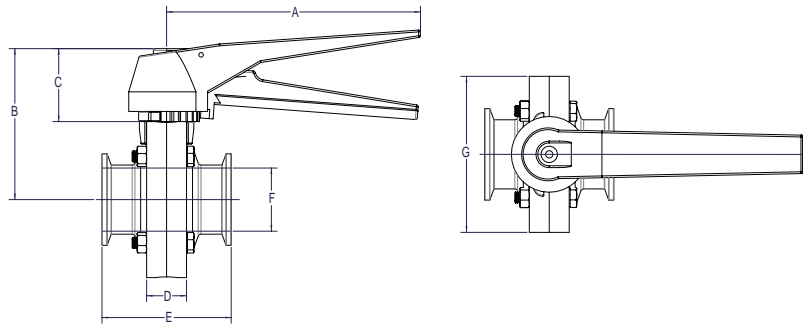

Size	Dimensions							304 Stainless Steel Part #
	A (in)	B (in)	C (in)	D (in)	E (in)	F (in)	G (in)	
1-1/2"	5.70	3.40	1.60	0.87	2.80	1.40	3.40	B5116S150CC-C
2"	5.70	3.60	1.60	0.87	3.00	1.90	3.90	B5116S200CC-C
3"	5.70	4.20	1.60	0.87	3.30	2.90	5.00	B5116S300CC-C
4"	6.89	5.51	1.60	0.87	3.62	3.83	6.89	B5116S400CC-C

#### Weld End with Trigger Handle

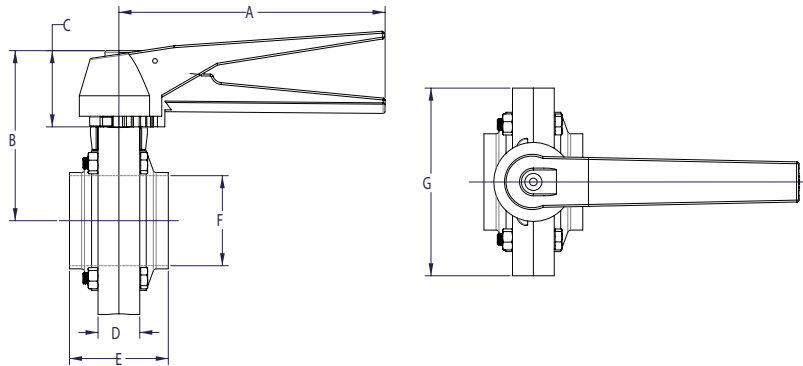

Size	Dimensions							304 Stainless Steel Part #
	A (in)	B (in)	C (in)	D (in)	E (in)	F (in)	G (in)	
1-1/2"	5.70	3.40	1.60	0.87	1.97	1.40	3.40	B5116S150BB-C
2"	5.70	3.60	1.60	0.87	2.05	1.90	3.90	B5116S200BB-C
3"	5.70	4.20	1.60	0.87	2.12	2.90	5.00	B5116S300BB-C
4"	6.89	5.51	1.60	0.87	2.52	3.83	6.89	B5116S400BB-C

#### Replacement Seats

Size	Part #
1-1/2"	B5116-RKS150
2"	B5116-RKS200
3"	B5116-RKS300
4"	B5116-RKS400

NOTE: Cannot be actuated and is supplied with silicone seats only.

M



## EHSC-Series Spring Check Valve



## Features

- Single piece upper body spider design
- Machined from solid bar
- Standard O-ring and gasket seal design
- Can be serviced in field (no special tools required)
- Finish: sanitary polish 32Ra
- Suitable for low and medium viscosity fluids
- Connection: clamp (standard), others available upon request



Size	Pressure Rating	Cracking Pressure (PSI)	Operating Temperature	HSC EPDM 316L Stainless Steel Part #	HSC FKM 316L Stainless Steel Part #	EHSC EPDM 316L Stainless Steel Part #	EHSC EPDM 316L Stainless Steel Part #
1/2"	145 PSI	10.0	15°F to 200°F (-9°C to 93°C)	HSCE050	HSCV050	EHSCE050	EHSCV050
3/4"		4.0		HSCE075	HSCV075	EHSCE075	EHSCV075
1"		2.5		HSCE100	HSCV100	EHSCE100	EHSCV100
1-1/2"		1.0		HSCE150	HSCV150	EHSCE150	EHSCV150
2"		1.5		HSCE200	HSCV200	EHSCE200	EHSCV200
2-1/2"		0.8		HSCE250	HSCV250	EHSCE250	EHSCV250
3"		0.5		HSCE300	HSCV300	EHSCE300	EHSCV300
4"		0.4		HSCE400	HSCV400	EHSCE400	EHSCV400

## Repair Kits

Size	FKM Part #	EPDM Part #
1/2"	HSC-RKV050	HSC-RKE050
3/4"	HSC-RKV075	HSC-RKE075
1"	HSC-RKV100	HSC-RKE100
1-1/2"	HSC-RKV150	HSC-RKE150
2"	HSC-RKV200	HSC-RKE200
2-1/2"	HSC-RKV250	HSC-RKE250
3"	HSC-RKV300	HSC-RKE300
4"	HSC-RKV400	HSC-RKE400

1/2"-3/4" repair kit contains:  
 (1) body gasket  
 (1) plunger O-ring  
 (1) spider O-ring

1"-4" repair kit contains:  
 (1) body gasket  
 (1) plunger O-ring

M

## Dimensions

Size	A (in)
1/2"	2.7
3/4"	2.7
1"	3.3
1-1/2"	3.4
2"	3.4
2-1/2"	3.4
3"	3.4
4"	4.1





1447



### HYC-Series Y - Ball Check Valve

**Applications**

- When liquid flows through the valve, the ball is forced into the branch of the valve allowing full fluid flow; when the liquid stops, equalizing the pressure, the ball drops back into the seat, preventing backflow; should reverse flow occur, the differential pressure will cause the ball to seal firmly against the seat preventing leakage

**Features**

- Two-piece construction
- Replaceable seat
- Can be serviced in field (no special tools required)

**Materials**

- Ball: PTFE
- Product contact surfaces: 316L stainless steel

**Specifications**

- Operating temperature range: 15°F to 200°F (-9°C to 93°C)
- Maximum operating pressure: 150 PSI

Size	Part #
1-1/2"	HYCEP150CCA
2"	HYCEP200CCA
2-1/2"	HYCEP250CCA
3"	HYCEP300CCA

NOTE: All part numbers include clamp connections, EPDM seat material, PTFE ball, and #7 polish.

For other configurations, contact Dixon Sanitary at 800.789.1718

**Dimensions**

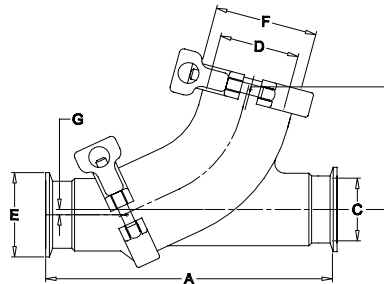

Valve Size	Clamp & Cap Size	A (in)	B (in)	C (in)	D (in)	E (in)	F (in)	G (in)	Ball Diameter (in)	Weight (lbs)
1-1/2"	2"	7.50	3.30	1.36	1.87	1.98	2.51	.16	1.6	4.9
2"	2-1/2"	8.50	3.90	1.86	2.33	2.51	3.04	.16	2.1	6.6
2-1/2"	3"	10.00	4.50	2.37	2.87	3.04	3.57	.16	2.7	10.5
3"	4"	11.50	5.30	2.87	3.83	3.57	4.68	.16	3.6	17.5

All dimensions are approximate. Engineering dimensions are available upon request. Specifications are subject to change without notice.

**Repair and Seal Kits**

Repair kit contains:

- (1) EPDM cap gasket
- (1) PTFE ball
- (1) EPDM/CF8M seat

Seal kit contains:

- (1) EPDM cap gasket
- (1) EPDM/CF8M seat

FKM seal kit contains:

- (1) FKM cap gasket
- (1) FKM /CF8M seat

Size	Repair Kit Part #	Seal Kit Part #	FKM Seal Kit Part #	Replacement Ball Only Part #
1-1/2"	B45BY-RK150	B45BY-SK150	B45BY-SKV150	B45BY-TB150
2"	B45BY-RK200	B45BY-SK200	B45BY-SKV200	B45BY-TB200
2-1/2"	B45BY-RK250	B45BY-SK250	B45BY-SKV250	B45BY-TB250
3"	B45BY-RK300	B45BY-SK300	B45BY-SKV300	B45BY-TB300

## B45 Air Blow Check Valves

### Feature

- Filter discs sold separately in packs of 50

### Materials

- 316L stainless steel
- Stem seat and gasket: EPDM

### Specifications

- Maximum operating temperature: 212°F (100°C)
- Maximum operating pressure: 145 PSI

### Approval

- Conforms to 3A standards for filtration of air entering tanks or pipelines with optional filter disc

Size	Quick-Connect Plug Part #	Female NPT Part #	Hose Barb Part #
1-1/2"	B45AB-R100150	B45BC-R100150	B45CC-R100150
2"	B45AB-R200	B45BC-R200	B45CC-R200
2-1/2"	B45AB-R250	B45BC-R250	B45CC-R250
3"	B45AB-R300	B45BC-R300	B45CC-R300
4"	B45AB-R400	B45BC-R400	B45CC-R400



### Dimensions

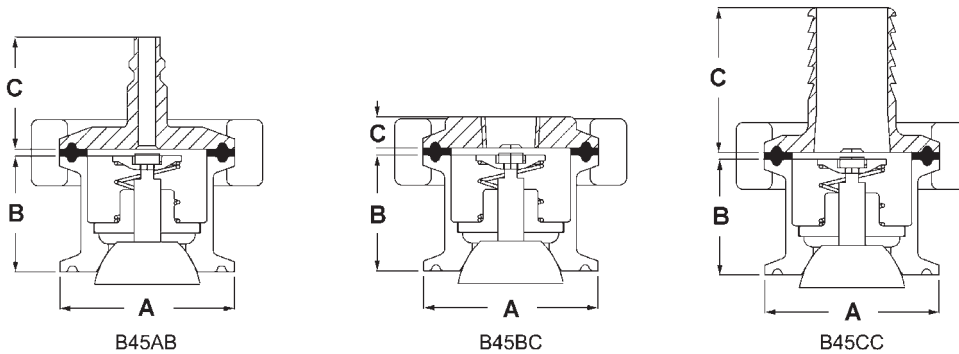

Size	A (in)	B (in)	C (in) Plug	C (in) FNPT	C (in) Hose Barb
1"-1-1/2"	1.984	1.30	1.26	.6	1.7
2"	2.516	1.30	1.26	.6	1.7
2-1/2"	3.047	1.30	1.26	.6	1.7
3"	3.579	1.30	1.26	.6	1.7
4"	4.682	1.30	1.26	.6	1.7

NOTE: All dimensions are approximate. Engineering dimensions are available upon request. Specifications are subject to change without notice.

### Repair Kit

- Repair kit, B45AB-RK, contains
- (1) EPDM / 316L stainless perforated disc
  - (1) 304 stainless spring retainer
  - (1) 304 stainless spring
  - (1) nylon stem guide
  - (1) 316L / EPDM stem and plug

### Sizing Chart

When using air blow check valves with ball check valves, refer to the sizing chart below.

Ball Check Valve Size	Air Blow Check Valve Size
1-1/2"	2"
2"	2-1/2"
2-1/2"	3"
3"	4"



### HAV-Series Air Relief Check Valves

Used to bleed a line when an air pocket has formed because of the installation and requires the valve to be installed at the top of the line.

Also used to bleed off a tube on the suction side of a pump. The suction side is bled automatically before the pump starts, creating a vacuum. In this application, the valve is mounted in front of the pump, on the top of the inlet tube.

The air relief valve allows air to be removed from a line or container without the liquid flowing out. It does not allow air to enter the line or container, even if subjected to a negative pressure.

They are found in food processing, beverage, dairy, personal care, winery, brewery, pet product, and industrial markets.

NOTE: 3A approved only when used with elbow extension.

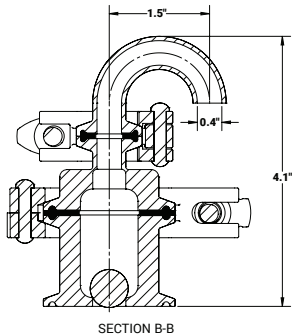

**Sizes**

- 1-1/2" to 2"

**Features**

- No special tools required
- Ball and gaskets are replaceable
- Valve seals are for both pressure and vacuum

**Materials**

- Materials of construction technical data:
  - product contact components: 304 stainless steel
  - ball: polypropylene (standard) or PTFE
  - gasket: EPDM (standard); others available upon request

**Specifications**

- Product temperature technical data:
  - maximum operating temperature: 212°F (100°C)
- Product pressure technical data:
  - maximum operating pressure: 145 PSI
- Surface finish technical data:
  - product contact components: Ra ≤ 32
  - others available upon request

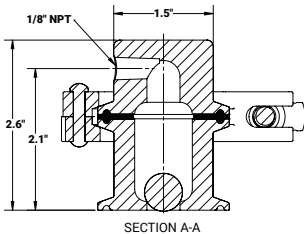

Size	3A Elbow Part #	NPT Part #
1-1/2"	HAV3EA150	HAVNEA150
2"	HAV3EA200	HAVNEA200

NOTE: All part numbers include clamp connections, EPDM seat material, polypropylene ball, and #7 polish.

For other configurations, contact Dixon Sanitary at 800.789.1718

M

## Air & Vacuum Relief Tank Vent Valves

### Applications

- When product filling or emptying a tank, this valve is used to relieve pressure or vacuum

### Features

- Triple action:
  - valve relieves pressure as the fluid level rises while filling a tank
  - valve relieves vacuum as the fluid level drops while emptying a tank
  - seals under equal pressure
- Stainless steel screen surrounds the entire vacuum and pressure flow area
- Other sanitary connections optional
- 1/4" FNPT connection for gas inlet; plug also supplied
- Repair kits available

### Materials

- 304 stainless steel
- EPDM elastomer

### Specifications

- Vacuum break: 2" water column, **0.1 PSI**
- Pressure relief: 22" water column, **0.8 PSI**
- Maximum temperature and pressure rating: **3 PSI @ 70°F (21°C)**
- Maximum flow rate: **500 GPM**

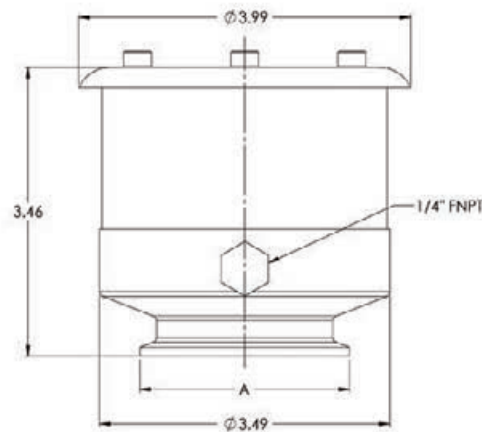
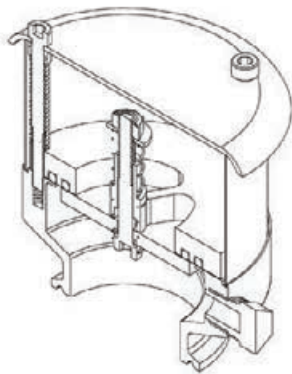
**M**

Tube O.D.	Dimension A (in)	304 Stainless Steel Part #
2"	2.52	TVSEC-G200
3"	3.58	TVSEC-G300
4"	4.68	TVSEC-G400



NOTE: Due to the impossible determination of whether a tank was damaged due to the tank vent or the lack of opening the upper manhole during product transfer, Dixon Sanitary assumes no liability for tank damage or product loss.

NOTE: All dimensions are approximate. Engineering dimensions are available upon request.

NOTE: Specifications are subject to change without notice.

### Air & Vacuum Relief Tank Vent Valve

**Features**

- Dome helps in preventing external contamination
- Can use any clamp gasket

**Materials**

- Light weight, robust PVC and 304 stainless steel construction

**Specifications**

- Maximum flow rate: **500 GPM**
- Vacuum break: **0.1 PSI**
- Pressure relief: **0.1 PSI**



Size	304 Stainless Steel Part #
2" - 3"	TVPC200-300

**Dimensions**

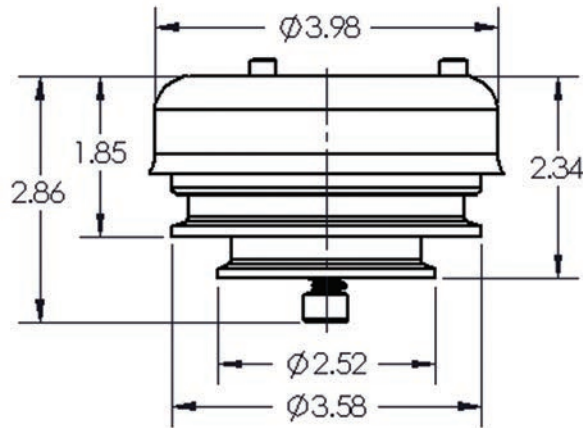

**!** NOTE: Due to the impossible determination of whether a tank was damaged due to the tank vent or the lack of opening the upper manhole during product transfer, Dixon Sanitary assumes no liability for tank damage or product loss.

NOTE: All dimensions are approximate. Engineering dimensions are available upon request.  
 NOTE: Specifications are subject to change without notice.

## 3A Sample Valves with Manual Handle

### Applications

- The 3A sample valve allows easy and safe sampling of liquids from closed systems such as vessels and pipelines.
- These valves are located in the pharmaceutical, bio-pharmaceutical, biochemical, cosmetic, food, dairy, and beverage markets.

### Features

- Valve body made from solid bar
- No dead space
- Drainable
- Connections suitable for orbital welding
- Available with single or dual ports
- Hermetically sealed against environment
- Optimum cleanability
- Change of seals without special tools
- Long life of the PTFE-bellows
- Low spare part costs
- Options for pneumatic actuator: no lever, with self-closing lever and with lever for open position
- Manual actuator (hand wheel)

### Materials

- In product contact: 1.4404/AISI 316L
- Non product contact: 1.4301/AISI 304
- Product contact seals: PTFE bellows
- Surfaces: wetted product surfaces: Ra <= 32 (optional surface finishes available), Non product contact: Ra <= 63

### Specifications

- Closing tension operating pressure: maximum **116 PSI**
- Hand wheel version operating pressure: minimum **87 PSI**, maximum **232 PSI**
- Controlled air pressure: maximum **145 PSI**



single port



double port

Clamp Valve Size	Weld Port Size	Single Port Part #	Dual Port Part #
1/2"	1/4"	BSVS-HC050B025	BSVD-HC050B025
	3/8"	BSVS-HC050B375	BSVD-HC050B375
	1/2"	BSVS-HC050B050	BSVD-HC050B050
1" - 1-1/2"	1/4"	BSVS-HC100B025	BSVD-HC100B025
	3/8"	BSVS-HC100B375	BSVD-HC100B375
	1/2"	BSVS-HC100B050	BSVD-HC100B050
2"	1/4"	BSVS-HC200B025	BSVD-HC200B025
	3/8"	BSVS-HC200B375	BSVD-HC200B375
	1/2"	BSVS-HC200B050	BSVD-HC200B050
2-1/2"	1/4"	BSVS-HC250B025	BSVD-HC250B025
	3/8"	BSVS-HC250B375	BSVD-HC250B375
	1/2"	BSVS-HC250B050	BSVD-HC250B050
3"	1/4"	BSVS-HC300B025	BSVD-HC300B025
	3/8"	BSVS-HC300B375	BSVD-HC300B375
	1/2"	BSVS-HC300B050	BSVD-HC300B050
4"	1/4"	BSVS-HC400B025	BSVD-HC400B025
	3/8"	BSVS-HC400B375	BSVD-HC400B375
	1/2"	BSVS-HC400B050	BSVD-HC400B050

## Fire Hose .....751 - 765

300# single jacket all polyester.....	751
500# single jacket all polyester.....	752 - 753
UL labeled .....	752
Color impregnated.....	753
800# double jacket all polyester .....	753
Color impregnated.....	753
MSHA approved single jacket mine .....	754
Double jacket potable water hose.....	754
500# all polyester rack .....	754 - 755
UL labeled .....	754
Non-UL labeled .....	755
500# nitrile covered .....	755
Forestry non-weeping .....	756
Forestry mop up .....	756
Forestry mop up kit.....	756
Nitrile covered - heavy duty .....	757
Non-collapsible .....	758
Chemical booster .....	758
Fire and utility.....	758
Single jacket mill.....	759 - 761
Double jacket mill.....	762
Nitrile washdown .....	763 - 765
PVC flexible suction hose.....	765

## Fire House Couplings.....766 - 769

Expansion ring couplings.....	766 - 767
Washers.....	767
Ring and gasket guide.....	768
Hose type booster couplings.....	769
Forestry couplings.....	769

## Racks, Reels, Hose Cabinet.....770 - 777

Style V Swing type hose storage.....	770
Swing type hose storage .....	771
Heavy duty swing type hose storage.....	771
Global continuous flow .....	772
Continuous flow .....	773
Carbon steel .....	774
Hump racks .....	775
Hose racks .....	775
Pin rack hose assembly .....	776
Semi automatic pin racks.....	776
Steel hose cabinet .....	777

## Hose Protection ..... 778

Fire jacket .....	778
Fire tape.....	778

## Nozzles.....779 - 794

Fog .....	779 - 781
Rack.....	781
Ball shutoffs .....	782
Nozzle tips.....	782
Plain hose .....	782
Twist .....	782
Red plain hose.....	783

UL play pipes .....	783
Street cleaning .....	783
U.S. Coast Guard approved .....	784
Monitors and nozzles .....	785 - 794
Constant flow .....	787-788
Fog .....	787 - 788
Garden hose.....	788
Break apart attack.....	789
Ball shut off .....	789, 791, 792
Pistol grip.....	789
Gallonage .....	790
Forestry.....	790 - 792
Penetrator.....	792
Straight stream.....	792
Viper™ forestry.....	793 - 794

## Adapters & Connections. ....795 - 850

Double hex .....	795
Rocker lug .....	795, 801, 803, 806 - 807, 809
Swivel.....	796 - 799, 808
Hydrant.....	800 - 803
Hazmat .....	802
Hex nipples .....	803 - 805
Style N37 .....	806 - 807
Style N54 .....	810
Double male hex .....	811 - 813
Style N36 .....	814
Cam & groove .....	814 - 815
Caps and plugs.....	816 - 821
Replacement swivels and accessories.....	821
Storz.....	822 - 826
Accessories .....	827
Wrenches.....	828 - 831
Suction.....	832
Continuous swivel.....	832
Pump head testers. ....	833
Manifolds.....	833
Dry hydrants .....	834
Roof connections.....	835 - 837
Siamese connections .....	838 - 842
Wall hydrant body .....	843
Snoots.....	844 - 845
Siamese assemblies.....	845 - 846
Single sprinkler connection .....	847
Single inlet and hydrant connections .....	847
Wall hydrants.....	847
Round I.D. plates .....	848
British Instantaneous .....	849 - 850
International shore.....	850

## Accessories. .... 851

## Valves.....852 - 872

## Specialty Products. .... 873



### 300# Single Jacket All Polyester Fire Hose

**Materials**

- Outer construction: single jacket, all polyester
- Tube construction: EPDM rubber lining

**Specifications**

- Proof pressure: **300 PSI**
- Service test pressure: **150 PSI** at ambient temperature **70°F (21°C)**
- Working pressure: **135 PSI** at ambient temperature **70°F (21°C)**

**Approvals**

- 25' and 75' lengths, UL labeled hoses and other threads and configurations are available; contact Dixon®

**Uncoupled**

Size	Bowl	Length	Part #
1-1/2"	1-3/4"	50'	A315-50UC
		100'	A315-100UC
2"	2-1/4"	50'	A320-50UC
		100'	A320-100UC
2-1/2"	2-13/16"	50'	A325-50UC
		100'	A325-100UC
3"	3-3/8"	50'	A330-50UC
		100'	A330-100UC



**Coupled with female and male expansion ring couplings**

Size	Length	Rocker Lug Aluminum NST (NH) Part #	Rocker Lug Brass NST (NH) Part #	Rocker Lug Aluminum NPSH Part #
1-1/2"	50'	A315-50RAF	A315-50RBF	A315-50RAS
	100'	A315100RAF	A315100RBF	A315100RAS
2"	50'	---	---	A320-50RAS
	100'	---	---	A320100RAS
2-1/2"	50'	A325-50RAF	A325-50RBF	A325-50RAS
	100'	A325100RAF	A325100RBF	A325100RAS
3"	50'	---	---	A330-50RAS
	100'	---	---	A330100RAS



### 500# Single Jacket All Polyester Fire Hose

**Feature**

- Other threads and configurations are available; contact Dixon®

**Materials**

- Outer construction: single jacket, all polyester
- Tube construction: EPDM rubber lining

**Specifications**

- Proof pressure: **500 PSI**
- Service test pressure: **250 PSI** at ambient temperature **70°F (21°C)**
- Working pressure: **225 PSI** at ambient temperature **70°F (21°C)**

**Uncoupled**

Size	Bowl	Length	Part #
1"	1-1/4"	50'	A510-50UC
		100'	A510-100UC
1-1/2"	1-3/4"	50'	A515-50UC
		100'	A515-100UC
2-1/2"	2-13/16"	50'	A525-50UC
		100'	A525-100UC



**Coupled with female and male expansion ring couplings**

Size	Length	Rocker Lug Aluminum NST (NH) Part #	Rocker Lug Brass NST (NH) Part #	Rocker Lug Aluminum NPSH Part #
1"	50'	A510-50RAF	---	A510-50RAS
	100'	A510100RAF	---	A510100RAS
1-1/2"	25'	A515-25RAF	---	A515-25RAS
	50'	A515-50RAF	A515-50RBF	A515-50RAS
	75'	A515-75RAF	---	A515-75RAS
	100'	A515100RAF	A515100RBF	A515100RAS
2-1/2"	25'	A525-25RAF	---	A525-25RAS
	50'	A525-50RAF	A525-50RBF	A525-50RAS
	75'	A525-75RAF	---	---
	100'	A525100RAF	A525100RBF	A525100RAS



### 500# Single Jacket Fire Hose - UL labeled

**Coupled with female and male expansion ring couplings**

**Feature**

- Impregnated hose and other length threads and configurations are available; contact Dixon

**Materials**

- Outer construction: single jacket, all polyester
- Tube construction: EPDM rubber lining

**Specifications**

- Proof pressure: **500 PSI**
- Service test pressure: **250 PSI** at ambient temperature **70°F (21°C)**
- Working pressure: **225 PSI** at ambient temperature **70°F (21°C)**

**Approval**

- Underwriters Listed

Size	Coupling Type	Length	NST Thread Part #
1-1/2"	combo lug, brass	50'	A515U50CBF
2-1/2"			A525U50CBF

N



### 500# Single Jacket Fire Hose - Color Impregnated

**Feature**

- Consult Dixon® for pricing and availability of other colors, lengths, threads, and configurations

**Materials**

- Outer construction: single jacket, all polyester
- Tube construction: EPDM rubber lining

**Specifications**

- Proof pressure: **500 PSI**
- Service test pressure: **250 PSI**
- Working pressure: **225 PSI** at ambient temperature **70°F (21°C)**

Coupled with female and male expansion ring couplings

Size	Coupling Type	Length	Color	Part #
1-1/2"	rocker lug, aluminum, NST (NH)	50'	yellow	A515Y50RAF
	rocker lug, aluminum, NPSH			A515Y50RAS
	rocker lug, aluminum, NST (NH)		red	A515R50RAF
	rocker lug, aluminum, NPSH			A515R50RAS
	rocker lug, aluminum, NST (NH)		orange	A515OR50RAF
	rocker lug, aluminum, NPSH			A515OR50RAS



orange



red

### 800# Double Jacket All Polyester Fire Hose

**Feature**

- Consult Dixon for pricing and availability of 75' lengths and other threads and configurations

**Materials**

- Outer construction: double jacket, all polyester
- Tube construction: EPDM rubber lining

**Specifications**

- Proof pressure: **800 PSI**
- Service test pressure: **400 PSI**
- Working pressure: **360 PSI** at ambient temperature **70°F (21°C)**

Coupled with female and male expansion ring couplings

Size	Length	Rocker Lug Aluminum NST (NH) RAF Part #	Rocker Lug Brass NST (NH) RBF Part #	Rocker Lug Aluminum NPSH RAS Part #
1-1/2"	25'	D815-25RAF	---	---
	50'	D815-50RAF	D815-50RBF	D815-50RAS
	100'	D815100RAF	D815100RBF	D815100RAS
2-1/2"	25'	D825-25RAF	---	---
	50'	D825-50RAF	D825-50RBF	D825-50RAS
	100'	D825100RAF	D825100RBF	D825100RAS



### 800# Double Jacket Fire Hose - Color Impregnated

**Feature**

- Other lengths, threads, couplings, and colors (yellow, red, blue, tan, orange, green, black) are available; contact Dixon

**Materials**

- Outer construction: double jacket, all polyester
- Tube construction: black, synthetic rubber liner

**Specifications**

- Proof pressure: **800 PSI** at **70°F (21°C)**
- Service test pressure: **400 PSI** at **70°F (21°C)**
- Working pressure: **360 PSI** at **70°F (21°C)**

Coupled with female and male expansion ring couplings

Size	Thread NH (NST)	Coupling Type	Length	Part #
1-1/2"	1-1/2"	rocker lug, aluminum NST (NH)	50'	D815Y50RAF
		rocker lug, aluminum NST (NH)	100'	D815Y100RAF
		rocker lug, aluminum NPSH	50'	D815Y50RAS
		rocker lug, aluminum NPSH	100'	D815Y100RAS
1-3/4"		rocker lug, aluminum NST (NH)	50'	D817Y50RAF
2-1/2"	2-1/2"	rocker lug, aluminum NST (NH)	50'	D825Y50RAF
		rocker lug, aluminum NST (NH)	100'	D825Y100RAF
3"		rocker lug, aluminum NST (NH)	50'	D8325Y50RAF



### MSHA Approved Single Jacket Mine Fire Hose

Coupled with female and male aluminum rocker lug expansion ring couplings



**Features**

- Outer construction: single jacket, synthetic flame resistant
- Tube construction: flame resistant lining

**Specifications**

- Proof pressure: **500 PSI** at 70°F (21°C)
- Service test pressure: **250 PSI** at 70°F (21°C)
- Working pressure: **225 PSI** at 70°F (21°C)

**Approval**

- Approved by Mine Safety and Health Administration (MSHA) for all mine fire protection applications

Size	Thread	Length	Part #
1-1/2"	NST (NH)	50'	SM515W50RAF
	NPSH		SM515W50RAS

### Double Jacket Potable Water Hose - Blue

**Features**

- Outer construction: double jacket, all polyester
- Tube construction: thermoplastic

**Specifications**

- Proof pressure: **600 PSI** at 70°F (21°C)
- Service test pressure: **300 PSI** at 70°F (21°C)
- Working pressure: **270 PSI** at 70°F (21°C)

**Approval**

- Liner is NSF approved for potable water; fittings are not, except for temporary / emergency drinking needs only

Coupled with female and male, brass or aluminum rocker lug, expansion ring couplings



Size	Thread	Length	Brass Expansion Ring Part #	Aluminum Expansion Ring Part #
1-1/2"	NPSH	50'	PW615B50RBS	PW615B50RAS
		100'	PW615B100RBS	PW615B100RAS
	NST (NH)	50'	PW615B50RBF	PW615B50RAF
		100'	PW615B100RBF	PW615B100RAF
2-1/2"	NPSH	50'	PW625B50RBS	PW625B50RAS
		100'	PW625B100RBS	PW625B100RAS
	NST (NH)	50'	PW625B50RBF	PW625B50RAF
		100'	PW625B100RBF	PW625B100RAF

N



### 500# All Polyester Rack Hose - UL Labeled

**Application**

- For pin rack service / emergency fire fighting only. Not to be used for washdown

**Specifications**

- Proof pressure: **300 PSI** at ambient temperature 70°F (21°C)
- Service test pressure: **150 PSI** at ambient temperature 70°F (21°C)
- Working pressure: **135 PSI** at ambient temperature 70°F (21°C)

**Materials**

- Outer construction: single jacket, all polyester
- Tube construction: clear thermoplastic

**Approval**

- Underwriters Listed

Coupled with female and male expansion ring couplings



Size	Coupling Type	Length	Folded Part #	Coiled Part #
1-1/2"	combo lug, brass NST (NH)	50'	R515U50CBF/F	R515U50CBF
		100'	R515U100CBF/F	R515U100CBF
		50'	R515U50RAF/F	R515U50RAF
		100'	R515U100RAF/F	---

### 500# All Polyester Rack Hose - non-UL Labeled

**Application**

- For pin rack service / emergency fire fighting only. Not to be used for washdown

**Materials**

- Outer construction: single jacket, all polyester
- Tube construction: clear thermoplastic

**Specifications**

- Proof pressure: **500 PSI** at ambient temperature 70°F (21°C)
- Service test pressure: **250 PSI** at ambient temperature 70°F (21°C)
- Working pressure: **225 PSI** at ambient temperature 70°F (21°C)

Coupled with female and male expansion ring couplings

Size	Coupling Type	Length	Folded Part #	Coiled Part #
1-1/2"	combo lug, brass NST (NH)	50'	R515-50CBF/F	R515-50CBF
		100'	R515100CBF/F	R515100CBF
		50'	R515-50RAF/F	R515-50RAF
		100'	R515100RAF/F	R515100RAF



### 500# Nitrile Covered Fire Hose - Light Duty Red

**Application**

- Ideal for industrial and construction washdown and discharge applications

**Feature**

- Other colors, threads, and configurations are available; consult Dixon®

**Materials**

- Outer construction: thin ribbed nitrile
- Tube construction: nitrile

**Specifications**

- Proof pressure: **500 PSI** at ambient temperature 70°F (21°C)
- Service test pressure: **250 PSI** at ambient temperature 70°F (21°C)
- Working pressure: **225 PSI** at ambient temperature 70°F (21°C)

Uncoupled

Size	Bowl	Length	Part #
1-1/2"	1-13/16"	50'	H515R50UC
2-1/2"	2-13/16"		H525R50UC
1-1/2"	1-13/16"	100'	H515R100UC
2-1/2"	2-13/16"		H525R100UC

Coupled with female and male expansion ring couplings

Size	Length	Rocker Lug Aluminum NST (NH) Part #	Rocker Lug Brass NST (NH) Part #	Rocker Lug Aluminum NPSH Part #
1-1/2"	50'	H515R50RAF	H515R50RBF	H515R50RAS
2-1/2"		H525R50RAF	H525R50RBF	H525R50RAS
1-1/2"	100'	H515R100RAF	---	H515R100RAS
2-1/2"		H525R100RAF	---	---



### Forestry Non-Weeping Fire Hose



**Features**

- Consult Dixon® for pricing and availability of 25' lengths and other threads and configurations
- Impregnation: yellow

**Materials**

- Outer construction: single jacket, all polyester
- Tube construction: thermoplastic

**Specifications**

- Proof pressure: **600 PSI** at ambient temperature 70°F (21°C)
- Service test pressure: **300 PSI** at ambient temperature 70°F (21°C)
- Working pressure: **270 PSI** at ambient temperature 70°F (21°C)

Coupled with female and male expansion ring couplings

Size	Length	Rocker Lug Aluminum NST (NH) Part #	Rocker Lug Aluminum NPSH Part #
1"	50'	NF610Y50RAF	NF610Y50RAS
	100'	NF610Y100RAF	NF610Y100RAS
1-1/2"	50'	NF615Y50RAF	NF615Y50RAS
	100'	NF615Y100RAF	NF615Y100RAS

### Forestry Mop Up Hose

**Application**

- Used on mop-up and low volume hand lines to fill pump cans supplying sprinklers and remote fire line protection



**Size**

- 50' coil diameter is 9"

**Features**

- Consult Dixon for pricing and availability of other threads and configurations
- Impregnation: yellow

**Materials**

- Outer construction: single jacket, synthetic
- Tube construction: thermoplastic

**Specifications**

- Proof pressure: **300 PSI** at ambient temperature 70°F (21°C)
- service test pressure: **150 PSI** at ambient temperature 70°F (21°C)
- Working pressure: **135 PSI** at ambient temperature 70°F (21°C)

Coupled with female and male brass ferrule type garden hose couplings

Size	Length	Part #
3/4"	50'	NF307Y50GHT
1-1/2"	50'	NF615-50RAQT <sup>1</sup>
	100'	NF615100RAQT <sup>1</sup>

<sup>1</sup> Coupled with quarter turn forestry couplings

### Forestry Mop Up Hose Kit

Description	Part #
kit contains: hose, pouch, and nozzle	NF307Y50GHT-KIT

N



## Nitrile Covered Fire Hose - Heavy Duty - Yellow

### Applications

- Ideal for heavy-duty washdown in refineries and power plants

### Features

- Extruded interlocking matrix fire hose with 100% synthetic circular woven polyester reinforcement
- Heavy ribbed for severe service
- 25' lengths, other colors, threads, and configurations are available; contact Dixon®

### Materials

- Outer construction: thick ribbed nitrile
- Tube construction: nitrile

### Specification

- Pressures supplied in the chart below are at ambient temperature 70°F (21°C).

Size	Proof Pressure PSI	Service Test Pressure PSI	Working Pressure PSI
1" - 3"	600	300	270
4"	450	225	200
5"	400	200	180
6"	300	150	135

#### Uncoupled

Size	Bowl	Length	Part #
1"	1-1/4"	50'	H610Y50UC
1-1/2"	1-13/16"	50'	H615Y50UC
2"	2-1/4"	50'	H620Y50UC
2-1/2"	2-13/16"	50'	H625Y50UC
3"	3-3/8"	50'	H630Y50UC
4"	4-3/8"	50'	H440Y50UC
5"	5-3/8"	50'	H450Y50UC

#### Coupled with female and male expansion ring couplings

Size	Length	Rocker Lug Aluminum NST (NH) RAF	Rocker Lug Brass NST (NH) RBF	Pin Lug Brass NST (NH) PBF	Rocker Lug Aluminum NPSH RAS
1"	50'	H610Y50RAF	---	---	H610Y50RAS
1-1/2"		H615Y50RAF	H615Y50RBF	H615Y50PBF	H615Y50RAS
2-1/2"		H625Y50RAF	H625Y50RBF	H625Y50PBF	H625Y50RAS

#### Coupled with female and male segmented Storz collar style couplings

### Features

- Working pressures can be achieved using appropriate expansion ring couplings
- Under no circumstance should the hose be used beyond the working pressure of the fittings to which it is coupled



### Approval

- Assembled hose should be hydrostatically proof tested before use and thereafter in accordance with NFPA 1962

Size	Length	Storz Size	Part #
4"	50'	4"	H440Y50SZ
5"	50'	5"	H450Y50SZ
	100'		H450Y100SZ



**Non-collapsible Hose**

**Chemical Booster Hose - Red**



**Size**

- 3/4" diameter hose is coupled with 1" threaded couplings

**Feature**

- Reinforced with multiple plies of high tensile Aramid yarn providing flexible strength

**Materials**

- Outer cover material: specially compounded red EPDM tough cover
- Inner tube material: smooth black synthetic EPDM rubber

**Specification**

- Working pressure: **800 PSI**

**Approval**

- Meets and exceeds NFPA standard 1961

**Coupled with female and male NST (NH) thread, chromed brass hole type couplings**

Size	Length	Part #
3/4"	50'	80B07-50HCF
	100'	80B07-100HCF
1"	50'	80B10-50HCF
	100'	80B10-100HCF

**Coupled with female and male NST (NH) thread, hole type coupling, aluminum expansion ring couplings**

Size	Length	Part #
3/4"	50'	80B07-50HAF
	100'	80B07-100HAF
1"	50'	80B10-50HAF
	100'	80B10-100HAF

**Fire and Utility Hose - Red**

**Features**

- Outer construction is designed to withstand abrasion
- Consult Dixon® for pricing and availability of other lengths, threads, and configurations
- Also available with chrome brass fittings

**Specifications**

- Working pressure: **200 PSI** at ambient temperature **70°F (21°C)**
- Burst pressure: **600 PSI** at ambient temperature **70°F (21°C)**

**Coupled with female and male NST (NH) thread, rocker lug, brass expansion ring couplings**



Size	Length	Part #
1-1/2"	50'	15B15-50RBF
	100'	15B15-100RBF

**Coupled with female and male NST (NH) thread, rocker lug, aluminum expansion ring couplings**



Size	Length	Part #
1-1/2"	50'	15B15-50RAF
	100'	15B15-100RAF

**Coupled with female and male NPSH thread, rocker lug, aluminum expansion ring couplings**



Size	Length	Part #
1-1/2"	50'	15B15-50RAS
	100'	15B15-100RAS

N



## Synthetic Single Jacket Mill Hose

### Application

- Used in open end water discharge applications only; not intended for firefighting service



### Feature

- Consult Dixon® for pricing and availability on 75' lengths and other threads and configurations

### Materials

- Outer construction: single jacket, all polyester
- Tube construction: black, PVC rubber

### Specifications

- Rated pressure: **250 PSI** at ambient temperature 70°F (21°C)
- Working pressure: **112 PSI** at ambient temperature 70°F (21°C)

#### Uncoupled

Size	Bowl	Length	Part #
1"	1-1/4"	50'	M10-50UC
		100'	M10-100UC
		300'	M10-300UC
1-1/2"	1-11/16"	25'	M15-25UC
		50'	M15-50UC
		100'	M15-100UC
2"	2-3/8"	25'	M20-25UC
		50'	M20-50UC
		100'	M20-100UC
2-1/2"	2-11/16"	25'	M25-25UC
		50'	M25-50UC
		100'	M25-100UC
3"	3-3/8"	25'	M30-25UC
		50'	M30-50UC
		100'	M30-100UC
4"	4-3/8"	25'	M40-25UC
		50'	M40-50UC
		100'	M40-100UC
6"	6-3/8"	25'	M60-25UC
		50'	M60-50UC



### Synthetic Single Jacket Mill Hose

**Application**

- Used in open end water discharge applications only; not intended for fire fighting service



**Feature**

- Consult Dixon® for pricing and availability on 75' lengths and other threads and configurations

**Materials**

- Outer construction: single jacket, all polyester
- Tube construction: black, PVC rubber

**Specifications**

- Rated pressure: **250 PSI** at ambient temperature **70°F (21°C)**
- Working pressure: **125 PSI** at ambient temperature **70°F (21°C)**

**Coupled with NPSH female and male expansion ring couplings**



Size	Length	Part #
1-1/2"	50'	M15-50RAS
	100'	M15100RAS
2"	50'	M20-50RAS
	100'	M20100RAS
2-1/2"	50'	M25-50RAS
	100'	M25100RAS

**Coupled with NST (NH) female and male expansion ring couplings**



N

Size	Length	Part #
1-1/2"	50'	M15-50RAF
	100'	M15100RAF
2-1/2"	25'	M25-25RAF
	50'	M25-50RAF
	100'	M25100RAF

**Coupled with MNPT x MNPT male expansion ring couplings**



Size	Length	Part #
1-1/2"	50'	M15-50RAT
	100'	M15100RAT
2"	50'	M20-50RAT
	100'	M20100RAT

## Synthetic Single Jacket Mill Hose

### Application

- Used in open end water discharge applications only™; not intended for fire fighting service



### Feature

- Consult Dixon® for pricing and availability of additional lengths and other configurations

### Materials

- Outer construction: single jacket, all polyester
- Tube construction: black, PVC rubber

**Coupled with NPSH female and male King™ short shank couplings, crimp sleeve, aluminum shank with brass pin lug swivel nut**

Size	Length	Working Pressure PSI at 70°F (21°C)	Part #
1-1/2"	25'	75	M15-25KAS
	50'		M15-50KAS
2"	25'	75	M20-25KAS
	50'		M20-50KAS
2-1/2"	25'	50	M25-25KAS
	50'		M25-50KAS
3"	25'	50	M30-25KAS
	50'		M30-50KAS



**Coupled with NST (NH) female and male King™ short shank couplings, crimp sleeve, aluminum shank with brass pin lug swivel nut**

Size	Length	Working Pressure PSI at 70°F (21°C)	Part #
1-1/2"	25'	75	M15-25KAF
	50'		M15-50KAF
2-1/2"	25'	50	M25-25KAF
	50'		M25-50KAF



**N**

**Coupled with female and male (C & E) global aluminum cam and groove, crimp sleeve**

Size	Length	Working Pressure PSI at 70°F (21°C)	Part #
1-1/2"	25'	112	M15-25GAX
	50'		M15-50GAX
2"	25'	112	M20-25GAX
	50'		M20-50GAX
2-1/2"	25'	112	M25-25GAX
	50'		M25-50GAX
3"	25'	112	M30-25GAX
	50'		M30-50GAX
4"	25'	112	M40-25GAX
	50'		M40-50GAX



## Synthetic Double Jacket Mill Hose

### Application

- Ideal for open end discharge applications; not intended for fire fighting service 

### Features

- Consult Dixon® for pricing and availability of additional lengths and other configurations
- Double jacket hoses are not recommended for use with field reattachable couplings 

### Materials

- Outer construction: double jacket, all polyester
- Tube construction: black, PVC rubber

### Specifications

- Rated pressure: **250 PSI at 70°F (21°C)**
- Working pressure: **200 PSI at 70°F (21°C)**

### Uncoupled



Size	Bowl	Length	Part #
1-1/2"	1-13/16"	50'	DM15-50UC
		100'	DM15-100UC
2"	2-5/16"	50'	DM20-50UC
		100'	DM20-100UC
2-1/2"	2-7/8"	50'	DM25-50UC
		100'	DM25-100UC

### Coupled with female and male NST (NH) thread, rocker lug, aluminum expansion ring couplings



Size	Bowl	Length	Part #
1-1/2"	1-13/16"	50'	DM15-50RAF
		100'	DM15100RAF
2-1/2"	2-7/8"	50'	DM25-50RAF
		100'	DM25100RAF

### Coupled with female and male NPSH thread, rocker lug, aluminum expansion ring couplings



Size	Bowl	Length	Part #
1-1/2"	1-13/16"	50'	DM15-50RAS
		100'	DM15100RAS
2"	2-5/16"	50'	DM20-50RAS
		100'	DM20100RAS
2-1/2"	2-7/8"	50'	DM25-50RAS
		100'	DM25100RAS

### Coupled with female and male NPT thread, rocker lug, aluminum expansion ring couplings



Size	Bowl	Length	Part #
1-1/2"	1-13/16"	50'	DM15-50RAT
		100'	DM15100RAT
2"	2-5/16"	50'	DM20-50RAT
		100'	DM20100RAT
2-1/2"	2-7/8"	50'	DM25-50RAT

### Coupled with female and male (C & E) global aluminum cam and groove, crimp sleeve



Size	Bowl	Length	Part #
1-1/2"	1-13/16"	50'	DM15-50GAX
		100'	DM15100GAX
2"	2-5/16"	50'	DM20-50GAX
		100'	DM20100GAX

N

## Nitrile Washdown Hose

### Application

- Ideal for industrial, agricultural, and construction washdown and discharge applications, not for firefighting 

### Feature

- Resistant to weather and abrasion

### Specification

- Working pressure: 200 PSI

#### Coupled with NPSH female and male expansion ring couplings

Size	Length	Part #
1-1/2"	50'	WDH15BK50RAS
	100'	WDH15BK100RAS
2"	50'	WDH20BK50RAS
	100'	WDH20BK100RAS
2-1/2"	50'	WDH25BK50RAS
	100'	WDH25BK100RAS



#### Coupled with NST female and male expansion ring couplings

Size	Length	Part #
1-1/2"	50'	WDH15BK50RAF
	100'	WDH15BK100RAF
2-1/2"	25'	WDH25BK25RAF
	50'	WDH25BK50RAF
	100'	WDH25BK100RAF



#### Coupled with MNPT x MNPT male expansion ring couplings

Size	Length	Part #
1-1/2"	50'	WDH15BK50RAT
	100'	WDH15BK100RAT
2"	50'	WDH20BK50RAT
	100'	WDH20BK100RAT



### Nitrile Washdown Hose

**Application**

- Ideal for industrial, agricultural, chemical, and construction washdown and discharge applications, not for firefighting



**Feature**

- Resistant to weather and abrasion

Coupled with NPSH female and male King™ short shank couplings, crimp sleeve, aluminum shank with brass pin lug swivel nut



Size	Length	Part #
1-1/2"	25'	WDH15BK25KAS
	50'	WDH15BK50KAS
2"	25'	WDH20BK25KAS
	50'	WDH20BK50KAS
2-1/2"	25'	WDH25BK25KAS
	50'	WDH25BK50KAS
3"	25'	WDH30BK25KAS
	50'	WDH30BK50KAS

Coupled with NST (NH) female and male King short shank couplings, crimp sleeve, aluminum shank with brass pin lug swivel nut



Size	Length	Part #
1-1/2"	25'	WDH15BK25KAF
	50'	WDH15BK50KAF
2-1/2"	25'	WDH25BK25KAF
	50'	WDH25BK50KAF

Coupled with female and male (C & E) global aluminum cam and groove, crimp sleeve



Size	Length	Part #
1-1/2"	25'	WDH15BK25GAX
	50'	WDH15BK50GAX
2"	25'	WDH20BK25GAX
	50'	WDH20BK50GAX
2-1/2"	25'	WDH25BK25GAX
	50'	WDH25BK50GAX
3"	25'	WDH30BK25GAX
	50'	WDH30BK50GAX
4"	25'	WDH40BK25GAX
	50'	WDH40BK50GAX

N

## Nitrile Washdown Hose

### Application

- Ideal for industrial, agricultural, and construction washdown and discharge applications, not for firefighting



### Feature

- Resistant to weather and abrasion

### Uncoupled

Size	Color	Bowl	Length	Working Pressure	Part #
1"	black	1-1/4"	50'	200 PSI	WDH10BK50UC
			100'		WDH10BK100UC
	yellow	1-1/4"	100'		WDH10Y100UC
			blue		1-1/4"
1-1/2"	black	1-13/16"			
			100'		WDH15BK100UC
2"	black	2-5/16"	50'		WDH20BK50UC
			100'		WDH20BK100UC
2-1/2"	black	2-13/16"	50'		WDH25BK50UC
			100'		WDH25BK100UC
3"	black	3-3/8"	50'	WDH30BK50UC	
			100'	WDH30BK100UC	
4"	black	4-3/8"	50'	WDH40BK50UC	
			100'	WDH40BK100UC	
6"	black	6-3/8"	50'	WDH60BK50UC	
			100'	WDH60BK100UC	



## Dixon® PVC Flexible Suction Hose

### Couplings with PVC Flexible Suction Hose

Size	Length	Thread	Female L/H x Male Part #	Female R/L x Male Part #	Storz x Storz Part #	Cam and Groove x Cam and Groove Part #
2-1/2"	10'	NST	FSH-9682-000	FSH-9682-050	FSH-9682-020	FSH-9682-030
		BAT	FSH-9682-000B	FSH-9682-050B		
		CSA	FSH-9682-000C	FSH-9682-050C		
		WCT	FSH-9682-000W	FSH-9682-050W		
		NS1	FSH-9682-000NS	FSH-9682-050NS		
		QST	FSH-9682-000Q	FSH-9682-050Q		
3"	10'	NH	FSH-9682-100	FSH-9682-150	FSH-9682-120	FSH-9682-130
4"			FSH-9682-200	FSH-9682-250	FSH-9682-220	FSH-9682-230
4-1/2"			FSH-9682-300	FSH-9682-350	---	---
5"			FSH-9682-400	FSH-9682-450	FSH-9682-420	FSH-9682-430
6"			FSH-9682-500	FSH-9682-550	FSH-9682-520	FSH-9682-530



cam & groove x cam & groove



female L/H x male R/L



storz x storz



### Expansion Ring Couplings

**Features**

- Shipped complete with expansion rings, swivel, and tail washers
- Aluminum expansion ring couplings have (3) rocker lugs on the male and female

**For Single Jacket Hose - Aluminum**



Size	Thread	Bowl	Aluminum Part #
1"	NPSH	1-1/4"	S10125
1-1/2"	NPSH	1-3/4"	S16175
		1-11/16"	S16168
		1-13/16"	S16181
2"	NPSH	2-1/4"	S20225
2-1/2"	NPSH	2-13/16"	S26281
1-1/2"	NST (NH)	1-11/16"	S16168F
		1-3/4"	S16175F
		1-13/16"	S16181F
2-1/2"	NST (NH)	2-11/16"	S26268F
		2-13/16"	S26281F
1-1/2"	MNPT	1-11/16"	MS16168T <sup>1</sup>
		1-3/4"	MS16175T <sup>1</sup>
2"	MNPT	2-1/4"	MS20225T <sup>1</sup>
2-1/2"	MNPT	2-11/16"	MS26268T <sup>1</sup>

<sup>1</sup> Male fitting only

**For Single Jacket Hose - Brass**

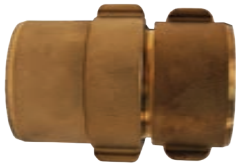

Size	Thread	Bowl	Brass Part #
1-1/2"	NPSH	1-3/4"	RS15175
		1-13/16"	RS15181
2-1/2"	NPSH	2-13/16"	RS25281
1-1/2"	NST (NH)	1-3/4"	RS15175F
		1-13/16"	RS15181F
2-1/2"	NPSH	2-13/16"	RS25281F

### Expansion Ring Couplings

**For Double Jacket Hose - Aluminum**

N



Size	Thread	Bowl	Aluminum Part #
1-1/2"	NPSH	1-13/16"	D16181
		1-15/16"	D16193
		2-1/16"	D16206
2"	NPSH	2-5/16"	D20231
2-1/2"	NPSH	3"	D263
1-1/2"	NST (NH)	1-13/16"	D16181F
		1-15/16"	D16193F
		2-1/16"	D16206F
2-1/2"	NST (NH)	2-7/8"	D26287F
		3"	D263F
1-1/2"	MNPT	1-13/16"	MD16181T <sup>1</sup>
2"	MNPT	2-5/16"	MD20231T <sup>1</sup>
2-1/2"	MNPT	2-7/8"	MD26287T <sup>1</sup>

<sup>1</sup> Male fitting only

**For Double Jacket Hose - Brass**

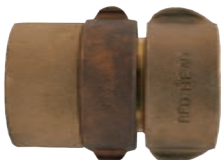

Size	Thread	Bowl	Brass Part #
1-1/2"	NPSH	1-15/16"	RD15193
	NST (NH)		RD15193F



## Expansion Rings

**Feature**

- Used with the fire hose couplings listed on page 766

O.D.	Length	Wall Thickness	85/15 red brass Part #
1"	1-1/4"	.05	ER10125
1-1/2"	3/4"	.05	ER1575
	7/8"		ER1587
	1"		ER1510
	1-1/4"		ER15125
1-3/4"	1-1/4"	.05	ER17125
2-1/2"	1-1/4"	.062	ER27125
	1-1/2"		ER27150
3"	2"	.07	ER3020



## Swivel Washers

**Feature**

- Used on the swivel end of the fire hose couplings listed on page 766

I.D.	O.D.	Thickness	Nitrile Rubber Part #
1-1/16"	1-7/16"	1/8"	SW100F
1-9/16"	2-1/16"		SW150
2-1/16"	2-1/2"		SW200
2-9/16"	3-3/16"	3/16"	SW250
3-1/16"	3-3/4"	1/4"	SW300F
4-1/16"	5-1/8"		SW400F
4-9/16"	5-7/8"		SW450F
5-1/16"	6-3/8"		SW500F
6-1/16"	7-1/8"		SW600F



## Tail Washers

**Feature**

- Used on the tail end of the fire hose couplings listed on page 766

I.D.	O.D.	Thickness	Nitrile Rubber Part #
1-1/32"	1-5/16"	3/16"	STW100
1-9/16"	1-3/4"		RTW150
1-9/16"	1-15/16"		STW150
1-5/8"	2-1/8"		DTW150
2-9/16"	3"	1/4"	STW250
2-5/8"	3-1/4"		DTW250
3-1/8"	3-25/32"		DTW300



Expansion Ring and Gasket Guide

Coupling Part #	Swivel Washer Part #	Tail Washer Part #	Expansion Ring Part #
D15193 & D15193F	SW150	DTW150	ER15125
D15206F	SW150	G12014	ER15125
D16187 & D16187F	SW150	DTW150	ER15125
D16193 & D16193F	SW150	DTW150	ER15125
D16206 & D16206F	SW150	G12014	ER15125
D253 & D253F	SW250	DTW250	ER27150
D26287F	SW250	DTW250	ER27150
D263 & D263F	SW250	DTW250	ER27150
MD16181T	n/a	STW150	ER15125
MD20231T	n/a	special	special
MD26287T	n/a	DTW250	ER27150
MS16168T	n/a	STW150	ER15125
MS16175T	n/a	STW150	ER15125
MS20225T	n/a	special	special
MS26268T	n/a	STW250	ER27150
RD15193 & RD15193F	SW150	DTW150	ER15125
RD15206 & RD15206F	SW150	G12014	ER15125
RD253 & RD253F	SW250	DTW250	ER27150
RH15168 & RH15168F	SW150	RTW150	ER1575
RH16168F & RH16168F	SW150	RTW150	ER1575
RS15175 & RS15175F	SW150	STW150	ER15125
RS15181 & RS15181F	SW150	STW150	ER1510
RS25281 & RS25281F	SW250	STW250	ER27125
RS25287	SW250	STW250	ER27150
S15175 & S15175F	SW150	RTW150	ER15125
S15181 & S15181F	SW150	RTW150	ER1510
S16168 & S16168F	SW150	STW150	ER15125
S16175 & S16175F	SW150	STW150	ER15125
S16181 & S16181F	SW150	STW150	ER15125
S25281 & S25281F	SW250	STW250	ER27125
S25287 & S25287F	SW250	STW250	ER27150
S26268 & S26268F	SW250	STW250	ER27150
S26275 & S26275F	SW250	STW250	ER27150
S26281 & S26281F	SW250	STW250	ER27150

N

### Hose Type Booster Hose Couplings

**Features**

- Special tooling is required to attach these couplings to hose
- Hardcoat finish
- Complete set

**Specifications**

- Working pressure: **800 PSI** at ambient temperature 70°F (21°C)
- 3/4 and 1" NST threads are the same size; also known as chemical hose thread (CHT) or booster hose thread



Hose Size	Thread Type	Bowl Size	Aluminum Hardcoat Part #
3/4"	1" NPSH	1-1/4"	ABH08125
1"	1" NST (NH)	1-7/16"	ABH10143F
		1-1/2"	ABH10150F

### Forged Forestry Couplings

**Feature**

- Common quarter turn sexless head (a 1-1/2" QT fitting will mate with a 3/4" QT or 1" QT)

**Specification**

- Maximum operating pressure: **300 PSI** at ambient temperature 70°F (21°C)

#### 1/4 Turn Male

Thread	Forged Aluminum Part #
3/4" GHT	QTM75GHT-F
1" NPSH	QTM100S-F
1" NPT	QTM100T-F
1 1/2" NST (NH)	QTM150F-F
1-1/2" NPT	QTM150T-F



#### 1/4 Turn Female

Thread	Forged Aluminum Part #
3/4" GHT	QTF75GHT-F
1" NPSH	QTF100S-F
1" NPT	QTF100T-F
1-1/2" NST (NH)	QTF150F-F
1-1/2" NPT	QTF150T-F



#### Forestry Coupling Gasket

Neoprene Part #
QTG-F



### Quick Connect Forestry Expansion Ring Couplings

**Feature**

- Sold in sets of (2) with expansion ring

Hose Size	Bowl Size	Forged Aluminum Part #
1-1/2"	1-11/16"	QTX150-F



### Style V Swing Type Hose Storage Reels

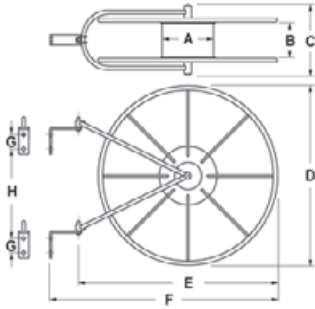

**Features**

- Drum storage of collapsible hose prevents damaging kinks, allowing longer hose life
- Pivot mounting permits reel to swing to the proper angle preventing twists and kinks
- Open sides allow faster hose drying, to prevent mold and mildew
- Red polyester powder coat finish
- Wall mounting is standard; (2) wall mounting brackets included
- Style V5 (when used with 1-1/2" hose only), has a space between the reel sides to accommodate two widths of hose side by side, for maximum capacity in minimum space
- Replacement brackets - 1212-0930-4, (2) per set

Size	Hose Capacity			A	B	C	D	E	F	G	H	Steel Part #
	Rack	Single	Double									
1-1/2" - 1-3/4"	100'	75'	50'	8"	3"	7-1/2"	21"	23"	27"	2"	11-3/8"	FHR-V1
	150'	100'	75'	8"	3"	7-1/2"	26"	29"	33"	2"	15"	FHR-V2
1-1/2"	300'	200'	150'	8"	5-1/2"	9-1/2"	26"	30"	34"	2"	13"	FHR-V5
2" - 2-1/2"	150'	100'	75'	8"	5-1/2"	9-1/2"	26"	30"	34"	2"	13"	FHR-V5

### Covers for Style V Swing Type Hose Storage Reels

**Features**

- Velcro™ closures
- Printed on both sides



Cover for	Dimensions	Vinyl Coated Nylon Part #
FHR-V2	26"	FHR-C
FHR-V1	21"	FHR-C1
FHR-V5	26"	HSRC26

### Swing Type Hose Storage Reels

**Features**

- One piece wall bracket (14 gauge), for easier mounting
- 180° swing will also take pipe clamps to 3"
- Compact size - smaller reel hub to allow more hose storage
- Baked red enamel finish
- Welded construction - rim (18 gauge) hub cap, welded spokes form solid wheels, separated by a molded poly hub and bolted together to form a sturdy unit
- Hose is double rolled from the center of length coupled to valve and nozzle
- Hose is ready for action when completely removed and valve is open

**Material**

- 14 gauge steel support arms

Hose Size	Hose Capacity		Steel Part #
	Lightweight	Rubber Lined	
1-1/2"	150'	50' - 75'	HSR18
	250'	100'	HSR24
2-1/2"	100'	100'	HSR25-24

**Dimensions**

Cover for	A	B	C
HSR18	18"	23-1/2"	6-1/4"
HSR24	24"	29"	6-1/4"
HSR25-24	24"	29"	8-1/4"

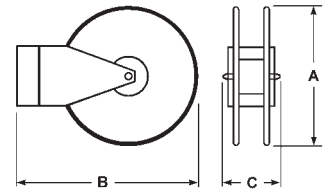

**Covers for Swing Type Hose Reels**

**Application**

- To be used with hose storage reels, bright red fabric reinforced PVC with Velcro™ closures for quick release

**Feature**

- "Fire Hose / Keep Clear" printed on one side

Cover for	Dimensions	Vinyl Part #
HSR18	16" - 18"	HSRC18
HSR24	24"	HSRC24
HSR25-24	24" - 25"	HSRC25-24



### Heavy Duty, High Capacity Swing Type Hose Storage Reel

**Features**

- Welded steel wall bracket swings 180°
- Wall bracket adapts to pipes (1-1/2" - 3") with an optional pipe bracket kit
- Red baked enamel finish
- Supplied with hook-and-loop back strap to keep hose securely wound

Size	Hose Capacity		16-gauge steel Part #
	Single Jacket	Double Jacket	
1-1/2"	200'	150'	DXHDR25HC
2-1/2"	100'	75'	

**Cover for Heavy Duty Swing Type Hose Storage Reel**

**Application**

- To be used with hose storage reels

**Feature**

- "Fire Hose / Keep Clear" printed on one side

Cover for	Dimensions	Vinyl Part #
DXHDR25HC	l: 26", h: 25", w: 8"	DXHDRC25HC



**Pipe Brackets for Heavy Duty Swing Type Hose Storage Reel**

Description	Vinyl Part #
pipe bracket set	DXHDR25PB



Global Continuous Flow Reels

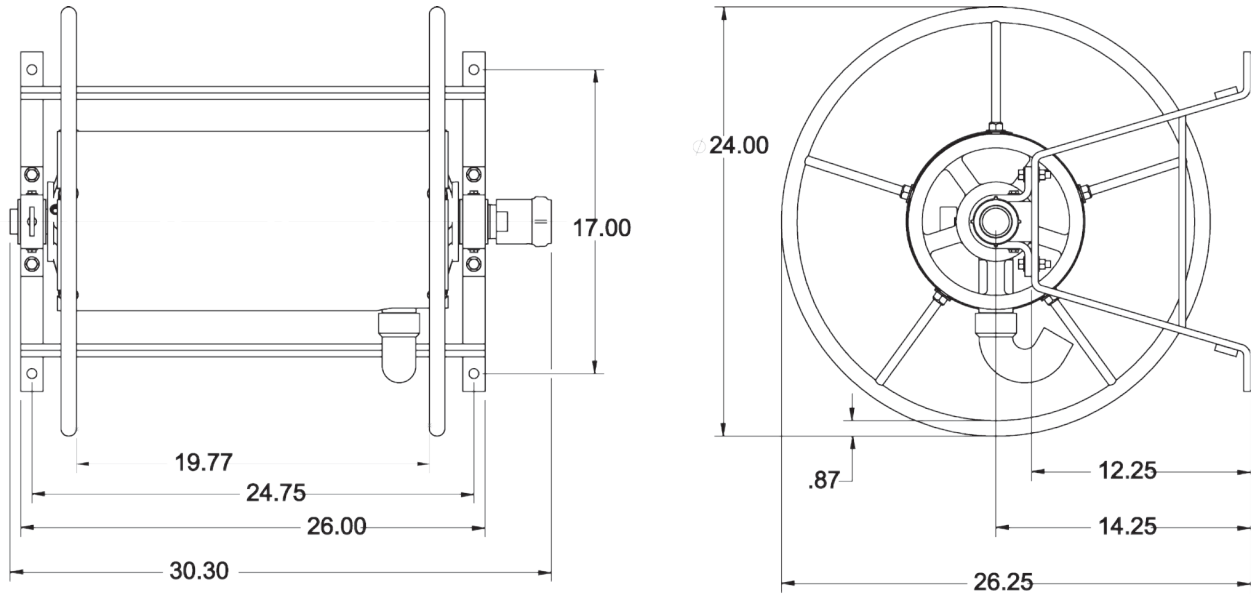

Features

- Greaseless swivel and reel bearings improve performance
- Optional adapters (order separately):  
 FM15S15F = 1-1/2" FNPSH x 1-1/2" MNST brass  
 FM15I15F = 1-1/2" FNPT x 1-1/2" MNST brass
- Replacement inlet swivel joints at bottom of page

Hose Size and Capacity		Inlet Size	Outlet Size	Steel Part #
3/4"	250'	1-1/2" NPT	1-1/2" NPT	FD47IR-150-100
1"	150'			
1-1/2"	100'			

Cover for Global Continuous Flow Hose Reel



Cover for	Dimensions	Vinyl Part #
FD47IR-150-100	22" x 24" x 24"	FD47-C2

Replacement Inlet Swivel Joint for FD47I-150-100



Features

- Ball-bearing swivel
- Requires no lubrication

Specification

- 200 PSI

Size	Cast Brass Part #
1-1/2"	CSSF150T

N

## Continuous Flow Reels

### Features

- Allows immediate and continuous flow of water at all times during deployment of hose
- One-person operation
- Use with non-collapsible hose shown on page 758
- Powder coated with an electrostatically-applied, thermally-fused, red polyester finish steel drum
- Rims and universal mounting stand

### Specification

- Female NPT inlet with male NST (NH) hose thread outlet

A flexible connector assembly must be installed directly between the hose reel inlet hub and the water supply. Failure to use the flexible connector assembly will void the warranty.

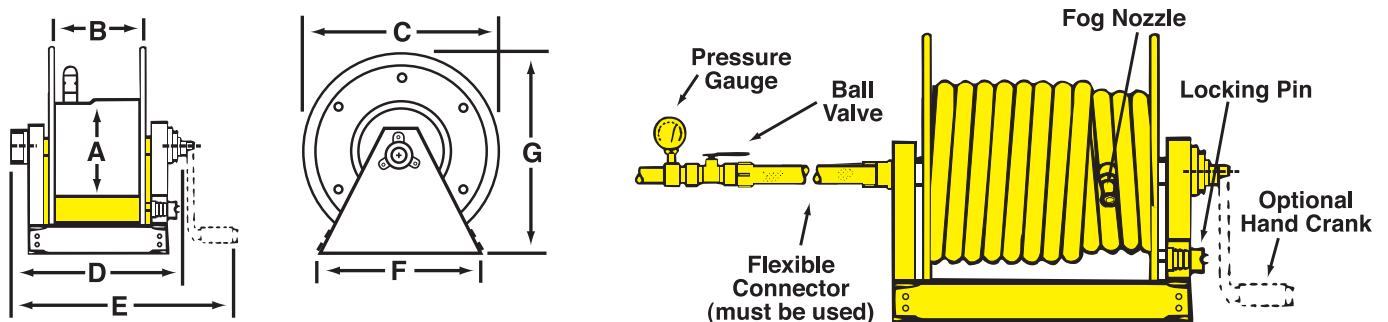

Hose Size and Capacity			A	B	C	D	E	F	G	Inlet Size	Outlet Size	Steel Part #
3/4"	1"	1-1/2"										
150'	125'	---	10-1/2"	11-1/2"	24"	19-1/4"	24"	21-3/4"	26"	1"	1"	CFR47-1-100
250'	150'	100'	10-1/2"	20-1/2"	24"	28-1/4"	33"	21-3/4"	26"	1-1/2"	1-1/2"	CFR47-150-100
400'	300'	150'	10-1/2"	28"	24"	35-3/4"	40-1/2"	21-3/4"	26"	1-1/2"	1-1/2"	CFR47-1-200
---	---	200'	10-1/2"	34"	24"	41-3/4"	46-1/2"	21-3/4"	26"	1-1/2"	1-1/2"	CFR47-150-200

### Optional Accessories

Description	Part #
1" x 18" flexible connector (male NPT x male NPT)	DX2836
1-1/2" x 18" flexible connector (male NPT x male NPT)	DX2839
hand crank	CFR-HC
repair kit: contains O-ring, PTFE retaining ring for the inlet casting, spacer washer, and (2) steel retaining rings for the manifold	CFR-RK

### Covers for Continuous Flow Hose Reels

Cover for	Dimensions H x W x D	Vinyl Part #
CFR47-1-100	26" x 20" x 26"	CFR47-C1
CFR47-1-200	26" x 36" x 26"	CFR47-C2
CFR47-150-100	26" x 29" x 26"	CFR47-C3
CFR47-150-200	26" x 42" x 26"	CFR47-C4



### Carbon Steel Hose Reels



HD150-100PCR

**Sizes**

- 24" stand
- Inlet: brass 1-1/2" MNPT 90° swivel
- Outlet: brass 1-1/2" MNST gooseneck
- 1-1/2" non-collapsible UVX hose (up to 150')

**Features**

- Friction brake
- Left hand inlet
- Right hand inlet
- Red hose reel cover (hose not included)
- Natural, galvanized finish or red powder coated
- Made in USA
- Custom colors available; contact Dixon®

**Materials**

- Reel and frame: heavy-duty welded carbon steel
- Reel and frame: hot dipped galvanized
- Waterway: brass and stainless steel
- Hardware: 316L stainless steel
- Bearings: greaseless polyethylene
- Hose roller assembly (aluminum or stainless steel brackets)
- Manual rewind hand crank (stainless steel with polyethylene handle)

**Specifications**

- Maximum working water pressure: **200 PSI**
- Inlet: brass 1-1/2" FNPT straight swivel inlet

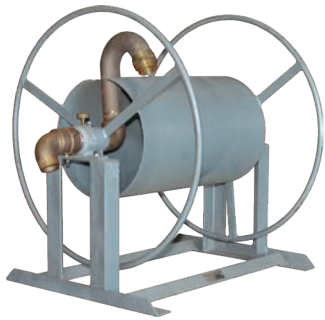

HD150-100G

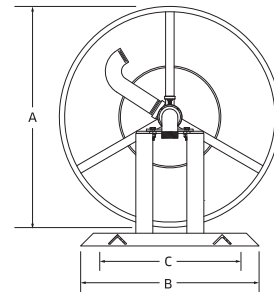
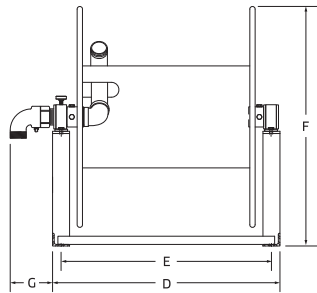

HD150-100PCRACC

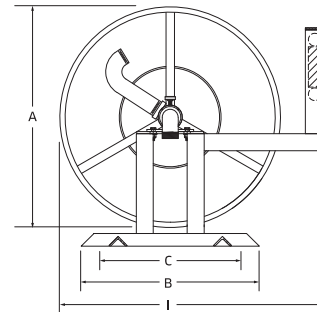
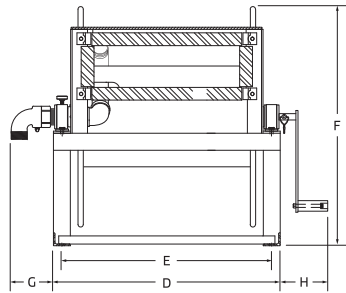

Hose Capacity		Dimensions								
		A	B	C	D	E	F	G	H	I
3/4"	0-250'	26"	21"	17"	26"	24-3/4"	29-3/16"	5"	5-9/16"	31"
1"	0-200'									
1-1/2"	0-150'									

Description	Part #
standard features, galvanized finish	HDR150-100G
hose roller assembly (aluminum), hand crank, galvanized finish	HDR150-100GACC
standard features, galvanized and powder coated (red) finish	HDR150-100PCR
hose roller assembly (aluminum), hand crank, galvanized and powder coated (red) finish	HDR150-100PCRAC



## Hump Racks

### Features

- Compact, neat, and economical method of storing collapsible hose
- Pivot mounting permits rack to swing, preventing kinks and twists
- Rugged steel construction provides long, dependable service
- Red enamel finish for protection
- Open sides allow faster drying to prevent mold and mildew
- Wall mounting brackets are standard

Hose Size	Hose Capacity			Steel Part #
	Synthetic	Single Jacket	Double Jacket	
1-1/2" - 1-3/4"	100'	50'	---	FHHR-1
	150'	100'	50'	FHHR-3
2" - 2-1/2"	100'	50'	---	FHHR-2
	150'	100'	50'	FHHR-4
1-1/2" - 1-3/4"	200'	150'	100'	FHHR-5



### Covers for Hump Racks

Cover for	Dimensions	Vinyl Part #
FHHR-1 or FHHR-2	16" x 25-1/2" x 6"	FHHR-C
FHHR-3 or FHHR-4	24" x 29-1/2" x 6"	FHHR-C4
FHHR-5	33-1/2" x 35-1/2" x 6"	FHHR-C5



## Hose Racks

### Features

- Can be used for fire or water hose
- Provides compact and economical hose storage
- Curved saddle design avoids sharp bends in the hose prolonging hose life
- Red enamel finish

### Material

- Constructed from 12 gauge sheet steel

Hose Size	Hose Capacity			Steel Part #
	Rack	Single Jacket	Double Jacket	
1-1/2" - 1-3/4"	50'	---	---	HR1610-3
	100'	---	---	HR1610-6
1-1/2" - 2-1/2"	200'	150'	100'	HR1610
2" - 2-1/2"	50'	---	---	HR1610-4





### Pin Rack Hose Assembly



**Specifications**

- Components include: rack nipple, UL 300 PSI angle valve, semi-automatic fire hose pin rack, brass rack nozzle, and a length of 1-1/2" pin rack hose

**Approvals**

- UL listed and Factory Mutual approved
- Per NFPA 1962, Chap. 4, in-service hose shall be un-racked and physically inspected at least annually



NST (NH) Thread	Hose	Part #
1-1/2"	50'	FHPR150-50CBF
	75'	FHPR150-75CBF
	100'	FHPR150-100CBF

### Semi Automatic Fire Hose Pin Racks

**Features**

- Red enameled steel
- Holds up to 100' of either 1-1/2" or 2-1/2" rack hose



**Approval**

- 1-1/2" is UL listed and Factory Mutual approved

Hose Size	For use with		Steel Part #
	Valve	Nipple	
1-1/2"	AVF150	PRN150F	FHPR150
2-1/2"	AVF250	PRN250F	FHPR2515

### Covers for Pin Racks

**Application**

- Used on FHPR150, FHPR150-50CBF, FHPR150-75CBF, FHPR150-100CBF

**Feature**

- 10 oz. red vinyl with Velcro™ closures



Size	Vinyl Part #
25" x 30" x 6"	PRC

### Pin Rack Nipples

**Material**

- Finish: -C polished chrome plated



Male NPT	Male NST (NH)	Brass Part #
1-1/2"	1-1/2"	PRN150F
2-1/2"	2-1/2"	PRN250F

### Pin Rack Wall Bracket

**Application**

- Used to support hose rack independent of a stand pipe valve



Aluminum Part #
PRWB

N

## Steel Hose Cabinet



### Features

- Designed for wall installation, with or without legs, or free standing
- Supplied with holes in the back for wall mounting and 1" pipe couplings on the bottom for adding legs
- Hose, accessories, and mounting hardware not included
- Furnished without legs; if legs are required, contact Dixon®

### Material

- Red polyester coated finish on 18-gauge steel

### Approval

- Factory Mutual approved



### Steel Part #

HC30143

### Dimensions

Width	Depth	Height
60"	15"	48"

### Basic Approved Equipment for Hose Cabinet

Examples			Quantity Required		
Part #	Description	Page #	Factory Mutual	UL & FIA	ISO
A525-50RAF <sup>1</sup>	2-1/2" x 50' single jacket hose	752	4	5	5
A515-50RAF <sup>1</sup>	1-1/2" x 50' single jacket hose	752	2	0	0
UPP250F <sup>1</sup>	Underwriters play pipe	783	0	2	2
BFN250NST <sup>1</sup>	2-1/2" adjustable fog nozzle	780	2	0	0
BFN150NST <sup>1</sup>	1-1/2" adjustable fog nozzle	780	1	0	0
HA2515F <sup>1</sup>	2-1/2" x 1-1/2" pin lug adapter	800	1	0	0
233	universal spanner	828	4	5	5
189	adjustable hydrant wrench	829	2	2	2
PHFA6	6 lb. fire axe	851	0	1	1
FCB48	crowbar	---	0	1	1
SW150 <sup>1</sup>	1-1/2" hose coupling gasket	767, 768, 782, 814	4	5	5
SW250 <sup>1</sup>	2-1/2" hose coupling gasket	767, 768, 782, 814, 821	2	0	0

<sup>1</sup> Threads must be appropriate to the authority having jurisdiction

### Fire Jacket for Hose

**Application**

- Used to protect hose and hose assemblies, tubing, piping, wiring and cables from high temperatures, direct flame, or molten splash

**Features**

- Helps maintain line temperature and reduce environmental overheating and overcooling
- Sleeving slides easily over hose and expands to go over fittings
- Resistant to hydraulic fluids and lubricating oil
- Iron oxide red color
- Supplied in 50' lengths
- Made in USA

**Material**

- Compounded silicone rubber coating over fiberglass

**Specifications**

- Temperature range: -65°F to 500°F (-54°C to 260°C)

**Approvals**

- Completely non-asbestos, REACH - ROHS compliant
- Meets flammability requirements of UL 94 HB & UL 94 V-0



Nominal I.D.	Part #
1/4"	0610-4
3/8"	1010-6
1/2"	1310-8
5/8"	1610-10
3/4"	1910-12
7/8"	2210-14
1"	2510-16
1-1/4"	3210-20
1-1/2"	3810-24
1-3/4"	4510-28
2"	5110-32
2-1/2"	6410-40
3"	7610-48
4"	10210-64

### Fire Jacket Tape

**Application**

- Used to seal the ends of fire jackets to prevent fraying and fluid wicking

**Features**

- Completely non-asbestos
- Iron oxide red color
- Made in USA

**Specification**

- Temperature range: -45°F to 380°F (-45°C to 200°C)



Size	Length	Silicone Rubber Part #
1"	12 yards	FTH100

### Non-Adhesive Fire Tape

**Features**

- Fluid resistant to hydraulic fluids and lubricating oils
- Should be installed in a spiral wrap utilizing 30% to 50% overlap
- Iron oxide red color
- Made in the USA

**Specification**

- Temperature range: -65°F to 500°F (-54°C to 260°C)



Width	Length	Fiberglass Coated Silicone Rubber Part #
3"	50'	4055-3

N

## Bumpered Fog Nozzles



### Features

- Straight stream, capable of greater than 100° spray angle
- Twist shut-off and flow-type change

### Specification

- Maximum working pressure: **100 PSI**; maximum rated pressure: **175 PSI**

### Approvals

- FM Approved for class A and B fires
- UL certified for class A and B fires



BBN75

Size	Thread	Rated Flow at Rated Pressure (GPM)	Rated Flow at Wide Open: GPM @ 100 PSI	Approvals			Brass Part #
				FM	UL	ULC	
3/4"	GHT	54	54	✓	✓	✓	BBN75GHT
	NPSH			✓	✓	✓	BBN75
1"	NPSH	60	60	✓	✓	✓	BBN100
	NST			✓	✓	✓	BBN100NST

## Global Approved Fog Nozzles



### Applications

- Industrial
- Rack and reel assemblies

### Feature

- Straight stream, fog, shut-off

### Specification

- Maximum working pressure: **150 PSI** (water only)

### Approvals

- FM Approved
- UL certified, ULC Listed



N

Size	Thread	Brass Part #
1-1/2"	NPSH	GBN150
	NST	GBN150NST
2-1/2"	NST	GBN250NST



### Industrial Fog Nozzles

**Features**

- Delivers 30° - 60° - 90° fog pattern - shut-off - straight stream - fog
- Supplied with bumper

**Specification**

- Maximum operating pressure: 175 PSI (water only) at 70°F (21°C)

**Approval**

- UL listed and Factory Mutual approved for class A and B fires (except noted <sup>1,2</sup>)

Size	Thread	90° Spray GPM @ 100 PSI	Brass Part #
3/4"	GHT	---	BFN75GHT <sup>1</sup>
1"	NPSH	---	BFN75
1-1/2"		32	BFN100
2"		85	BFN150
2-1/2"		108	BFN200 <sup>1,2</sup>
1"	NST (NH)	205	BFN250
1-1/2"		32	BFN100NST
2-1/2"		85	BFN150NST
		205	BFN250NST <sup>2</sup>

<sup>1</sup> Not UL Listed

<sup>2</sup> Not Factory Mutual approved

NOTE: Replacement washers can be found on page 767

### Heavy Duty Industrial Fog Nozzles



**Features**

- Delivers 30° - 60° - 90° fog pattern - shut-off - straight stream - fog
- Supplied with bumper

**Approvals**

- Factory Mutual approved
- Products are to be reapproved; data subject to change in coming months

**Specification**

- Maximum operating pressure: 175 PSI (water only) at 70°F (21°C)

Size	Thread	90° Spray GPM @ 100 PSI	Brass Part #
1"	NPSH	---	HFN100
1-1/2"		88 (+/-12)	HFN150
1"	NST (NH)	---	HFN100NST
1-1/2"		88 (+/-12)	HFN150NST
	NYFD	---	HFN150NYFD

NOTE: Replacement washers can be found on page 767; flow rate chart on following page 781

### High Pressure Industrial Fog Nozzles



**Features**

- Combination straight stream and fog - shut-off - straight stream - fog
- Large one-piece rubber bumper with molded teeth
- Knurled base

**Specifications**

- Working pressure: 25 to 300 PSI (water only) at 70°F (21°C)

**Approval**

- Factory Mutual approved

Size	Thread	90° Spray GPM @ 100 PSI	Brass Part #
1-1/2"	NPSH	117	HPFN150
	NST (NH)		HPFN150NST

NOTE: Replacement washers can be found on page 767; flow rate chart on following page 781

### Electrical Fire All-Fog Nozzles



**Features**

- Delivers 30° - 60° - 90° fog pattern, shutoff to 30° fog, adjustable to 90° fog
- Supplied with bumper
- Use of this nozzle is not likely to prove hazardous when nozzle is held in excess of 10 feet from electrical apparatus and circuits not involving more than 250,000 volts

**Specification**

- Maximum operating pressure: 100 PSI (water only) at 70°F (21°C)

**Approvals**

- UL listed approved for class C fires
- Products are to be reapproved; data subject to change in coming month

Size	Thread	Wide Open GPM @ 100 PSI	Brass Part #
1-1/2"	NST (NH)	96	BFNE150NST
	NPSH		BFNE150

NOTE: Replacement washers can be found on page 767; flow rate chart on following page 781

### Fog Nozzles

**Features**

- Shutoff - straight stream - fog
- Brass stem

**Specification**

- Maximum operating pressure: 100 PSI (water only) at 70°F (21°C)

Size	Thread	90° Spray GPM @ 100 PSI	Polycarbonate <sup>1</sup> Part #	Polycarbonate <sup>2</sup> Part #
3/4"	GHT	8.0	FNB75GHT <sup>3,4</sup>	---
	NPS	30.9	FNB75S <sup>4</sup>	---
1"	NPS	11.4	FNB100S <sup>4</sup>	FN100S
		30.9	HGB100S	---
1-1/2"	NPS	83.6	FNB150S	FN150S
1"	NST (NH)	11.4	FNB100NST	FN100NST
		30.9	HGB100NST	---
1-1/2"	NST (NH)	83.6	FNB150NST	FN150NST

- <sup>1</sup> With bumper
- <sup>2</sup> Without bumper
- <sup>3</sup> Standard flow
- <sup>4</sup> 120° spray GPM @100 PSI

NOTE: Replacement washers can be found on page 767



with bumper



without bumper

### Fog Nozzle Flow Rate Chart

Part #	Inlet Pressure		Straight Stream		30°		60°		90°	
	PSI	kPa	GPM	LPM	GPM	LPM	GPM	LPM	GPM	LPM
BFN100	50	(345)	18	(68)	21	(79)	24	(91)	27	(102)
	75	(517)	22	(83)	25	(95)	28	(106)	32	(121)
	100	(690)	24	(91)	28	(106)	32	(121)	36	(136)
BFN250	50	(345)	90	(341)	120	(454)	130	(492)	145	(549)
	75	(517)	100	(379)	140	(530)	150	(568)	180	(681)
	100	(690)	110	(416)	165	(625)	180	(681)	205	(776)
HFN100	100	(690)	25	(95)	---	---	---	---	---	---
HFN150	100	(690)	---	---	---	---	---	---	86	(326)
HPFN150	275	(1040)	---	---	---	---	---	---	130	(492)

### Domestic Rack Nozzles

**Features**

- Delivers 30° - 60° - 90° fog pattern - shut-off - straight stream - fog
- Supplied without bumper

**Approvals**

- UL listed and Factory Mutual approved for class A and B fires
- Products are to be reapproved; data subject to change in coming months

**Specification**

- Maximum operating pressure: 100 PSI (water only) at 70°F (21°C)

Size	Thread	Wide Open GPM @ 100 PSI	Brass Part #
1-1/2"	NST (NH)	100	BRN150NST
	NPSH		BRN150

NOTE: Replacement washers can be found on page 767



N

### Global Rack Nozzles

**Features**

- Delivers 30° - 60° - 90° fog pattern - shut-off - straight stream - fog
- Supplied without bumper

**Approvals**

- UL listed and Factory Mutual approved for class A and B fires
- New UL and FM approvals are pending due to change in standard UL 401
- Products are to be reapproved; data subject to change in coming months

**Specification**

- Maximum operating pressure: 100 PSI (water only) at 70°F (21°C)

Size	Thread	Wide Open GPM @ 100 PSI	Brass Part #
1-1/2"	NST (NH)	100	BRN150NST-I
	NPSH		BRN150S-I

NOTE: Replacement washers can be found on page 767



### Ball Shut-Offs



**Feature**

- Full-time swivel base ensures durable rubber-like handle can be positioned for easy operation

**Specification**

- Maximum operating pressure: **100 PSI** (water only) at 70°F (21°C)

Thread	Length	Waterway	Cast Brass Part #
1-1/2" NST (NH)	4-3/4"	1-3/8"	BSO150NST
1-1/2" NPSH			BSO150S



**Replacement Part**

Description	Composite Part #
replacement handle	BSO150-H

### Nozzle Tips

**Feature**

- Straight stream only

**Specifications**

- Maximum operating pressure: **100 PSI** (water only) at 70°F (21°C)
- **74 GPM @ 100 PSI**



Thread	Length	Orifice	Satin Finish Brass Part #
1" NST (NH)	4-3/4"	1/2"	BNT100F
1" NPSH			BNT100S
1-1/2" NST (NH)			BNT150F
1-1/2" NPSH			BNT150S

### Plain Hose Nozzles

**Specification**

- Maximum operating pressure: **100 PSI** (water only) at 70°F (21°C)

N



Size	Thread	Overall Length	Orifice	Replacement Gasket	Satin Finish Brass	
					Previous Part #	Part #
3/4"	GHT	6"	1/4"	KRW5	500SN6	BN6
	NPSH	6"	1/4"	KRW5	---	BN7
1"	NPSH	8"	5/16"	KRW10	---	BN10
1-1/4"	NPSH	10"	3/8"	KRW15	---	BN12
1-1/2"	NPSH	10"	1/2"	KRW20	---	BN15
2"	NPSH	12"	9/16"	SW200	---	BN20
2-1/2"	NPSH	12"	1"	KRW35	---	BN25
1"	NST (NH)	8"	5/16"	SW100F	---	BN10F
1-1/2"	NST (NH)	10"	1/2"	SW150	---	BN15F
2-1/2"	NST (NH)	12"	1"	SW250	---	BN25F
1-1/2"	NYFD	10"	1/2"	SW150	---	BN15NYFD
2-1/2"	NYFD	12"	1"	SW250	---	BN25NYFD

### Imported Twist Nozzles

**Specification**

- Maximum operating pressure **150 PSI** (water only)



Thread Size	Length	Extruded Brass	
		Previous Part #	Part #
3/4" GHT	4"	---	BTN75
	6-3/4"	500-AN7	500AN4
			500AN7



### Red Plain Hose Nozzles

**Specification**

- Maximum operating pressure: **100 PSI** (water only) at 70°F (21°C)

Size	Thread	Length	Orifice	Polycarbonate Part #
1-1/2"	NPSH	10"	1/2"	PN15
	NST (NH)			PN15F



### UL Play Pipes with Tip

**Application**

- Often required in hydrant houses by insurance underwriters

**Features**

- Swivel handle, red marlin trim
- Comes standard with 1-1/8" orifice tip

**Specification**

- Maximum operating pressure: **100 PSI** (water only) at 70°F (21°C)

**Approvals**

- UL listed and Factory Mutual approved
- ULT male thread specification: 2-3/16" ODM x 12 TPI

Size	Female Thread	Male Thread	Overall Length	Brass Part #
2-1/2"	NST (NH)	ULT	30"	UPP250F
				playpipe only



### Tips

**Feature**

- Finish: satin

**Specification**

- Maximum operating pressure: **100 PSI** (water only) at 70°F (21°C)

**Approval**

- ULT male thread specification: 2-3/16" ODM x 12 TPI

Orifice	Cast Brass Part #
1-1/8"	UPPT
1-1/4"	UPPT125
1-1/2"	UPPT150
1-3/4"	UPPT175



### Street Cleaning Nozzles

**Feature**

- Welded fabrication

Size	Connection	Aluminum Part #
2"	female cam	200DBAL
3"	female cam	300DBAL



### U.S. Coast Guard Approved AFFF / Water Fog Nozzles



CGSN150F

**Application**

- Designed for maximum efficiency with AFFF (Aqueous Film Forming Foams) or water on shipboard, offshore rigs, and industrial applications

**Features**

- Corrosion resistant brass construction
- Rubber-like bumper and handle for added protection
- Zytel (nylon) horseshoe handle
- Double row of molded teeth for excellent fog pattern
- Flush without shutting down
- Constant gallonage in all fog and straight stream patterns
- Combination fog and straight stream

**Specification**

- Maximum operating pressure: **100 PSI** (water/AFFF only) at **70°F (21°C)**



CGSN151F

Thread NST (NH)	Description	Fog Flow GPM @ 100 PSI	Approval #	Brass Part #
1-1/2"	nozzle	95	162.027/13/0	CGSN150F
	nozzle w/pistol grip		162.027/14/0	CGSN151F

NOTE: Gaskets are special order. Please call 877.712.6179 for assistance.

Thread NPSH	Description	Fog Flow GPM @100 PSI	Brass Part #
1-1/2"	nozzle	95	CGSN150S
	nozzle w/pistol grip		CGSN151S

### U.S. Coast Guard Approved Fog Nozzles

**Application**

- Designed to US Coast Guard specifications for fighting fires with drafted water; required equipment for all commercial vessels under US registry

**Features**

- Corrosion-resistant brass construction
- Combination fog and straight stream for shipboard fire fighting
- Applicator tips are available; consult Dixon® for pricing and availability

**Specification**

- Maximum operating pressure: **100 PSI** (water/AFFF only) at **70°F (21°C)**



Thread	Fog Flow GPM @100 PSI	Cast Brass Part #
1-1/2" NST	55	CGN150NST
2-1/2" NST	108	CGN250NST

NOTE: Gaskets and tips are special order. Please call 877.712.6179 for assistance.

N

### Omega™ Monitor



**Features**

- Cast-in turning vanes for a more efficient flow
- 360° horizontal and 150° vertical travel
- 4 bolt hole pattern on flange

**Specification**

- Friction loss: **10 PSI** at **800 GPM** (.7 bar at 3030 LPM)

**Approval**

- Factory Mutual approved



Size	Inlet	Outlet	Waterway	Flow GPM	Brass Part #
17" x 11-1/2"	3" flange	2-1/2" MNST	3"	<b>1250</b>	AK3526-300FL

NOTE: For flange dimensions, diagrams and additional information please reference dixonvalve.com.

### Monitor Nozzle

**Features**

- Fixed teeth
- Combination straight stream and fog - no shutoff
- Fixed gallonage master stream nozzle

**Specifications**

- Factory set at **500 GPM** (1900 LPM); field changeable to **300** or **700 GPM** (1140 or 2660 LPM)
- Maximum operating pressure: **100 PSI** (water only)



Size	Thread	90° Spray GPM @ 100 PSI	Brass Part #
2-1/2"	NST (NH)	<b>500</b>	AK4450NST

NOTE: Gaskets are special order, please call 877.712.6179 for assistance.

### FirePro™ Monitor



**Features**

- 360° horizontal and 140° vertical travel
- Red epoxy finish standard
- 150# ASA raised face 4" flange

**Specification**

- Seamless 2-1/2" monitor - rated at **750 GPM**

**Approval**

- Factory Mutual approved

**Materials**

- Carbon steel construction, stainless steel discharge tip and ball bearings



Size	Inlet	Outlet	Waterway	Flow GPM	Carbon Steel Part #
22" x 13"	4" flange	2-1/2" MNST	2-1/2"	<b>750</b>	FP475S

NOTE: Gaskets are special order, please call 877.712.6179 for assistance.

NOTE: For flange dimensions, diagrams and additional information please reference dixonvalve.com.

### Master Stream Nozzles

**Features**

- Featuring a straight stream to fog 'quick throw' pattern change
- Constant gallonage

**Specification**

- Factory set at **500 GPM**

Size	Thread	Material	Part #
2-1/2"	NST (NH)	brass	FP500B <sup>1</sup>
		aluminum	FP500A <sup>2</sup>



<sup>1</sup> Factory Mutual approved

<sup>2</sup> Not Factory Mutual approved

NOTE: Gaskets are special order, please call 877.712.6179 for assistance.



### Factory Mutual Approved Fog Nozzles



with bumper



without bumper

**Features**

- Shutoff - straight stream - fog
- Wings on sleeve for ease of adjustment

**Material**

- Brass stem with locking nut

**Specification**

- Maximum operating pressure: **100 PSI** (water only) at **70°F (21°C)**

**Approval**

- Factory Mutual approved

Size	Thread	90° Spray GPM @ 100 PSI	FM Approved Polycarbonate <sup>1</sup> Part #	Polycarbonate <sup>2,4</sup> Global Part #
3/4"	GHT	30.9	SL075GHT <sup>3</sup>	---
	NPSH	30.9	SL075 <sup>3</sup>	---
1"	NPSH	30.9	SL100 <sup>3</sup>	PFNB100S
1-1/2"	NPSH	75.0	SL150	PFNB150S
1"	NST (NH)	30.9	SL100NST	---
		75.0	SL150NST	PFNB150NST

<sup>1</sup> With bumper  
<sup>2</sup> Without bumper  
<sup>3</sup> 120° spray on 3/4" and 1"  
<sup>4</sup> Not Factory Mutual approve

### Polycarbonate Electrical Fire All-Fog Nozzles

**Feature**

- Opens and closes in a 30° fog pattern up to 120° - no straight stream

**Material**

- Brass stem

**Specification**

- Maximum operating pressure: **100 PSI** (water only) at **70°F (21°C)**



Size	Thread	75° Spray GPM @ 100 PSI	Polycarbonate Part #
1-1/2"	NPS	92	FNBE150S
	NST (NH)		FNBE150NST

### Fog Nozzle Gaskets



Size	Thread	I.D.	O.D.	Thickness	Nitrile Rubber Part #
1"	NPSH	0.937"	1.234"	0.125"	FNG100S
		1.000"	1.375"	0.125"	HGG100S
1-1/2"	NPSH	1.500"	1.827"	0.125"	FNG150S
1"	NST (NH)	0.937"	1.281"	0.125"	FNG100NST
		1.000"	1.375"	0.125"	HGG100NST
1-1/2"	NST (NH)	1.510"	1.906"	0.125"	FNG150NST

NOTE: Dimensions are nominal

### Constant Flow Fog Nozzles

**Features**

- Provides consistent volume at any spray angle
- Adjusts from straight stream to fog

**Specification**

- Maximum operating pressure: **100 PSI** (water only) at **70°F (21°C)**

**Material**

- Red polycarbonate with bumper and black plastic and steel stem

**Approval**

- 1" and 1-1/2" are ULC listed

Size	Thread	90° Spray GPM @ 100 PSI	Polycarbonate Part #
3/4"	GHT	8	CFB75GHT
1"	NPSH	22	CFB100S
1-1/2"	NPSH	75	CFB150S <sup>1</sup>
		150	HGCFB150S <sup>2</sup>
2"	NPSH	75	CFB2015S <sup>1</sup>
		150	CFB200S <sup>2</sup>
1"	NST (NH)	22	CFB100NST
1-1/2"	NST (NH)	75	CFB150NST <sup>1</sup>
		150	HGCFB150NST <sup>2</sup>
2-1/2"	NST (NH)	150	CFB250NST <sup>3</sup>
		215	HGCFB250NST <sup>2,4</sup>

<sup>1</sup> Standard flow

<sup>2</sup> High flow

<sup>3</sup> Provided with handles

NOTE: Gaskets located below

NOTE: NYF– New York Fire Dept. Thread 1" (2.100 ODM X 8 TPI) – 2-1/2" (3.030 ODM X 8 TPI)  
 CF – Chicago Fire Dept. Thread 1-1/2" (1.933 ODM X 11.5 TPI) – 2-1/2" (2.990 ODM X 7.5 TPI)  
 NYC– New York Corporation Thread 1-1/2" (2.093 ODM X 11 TPI) – 2-1/2" (3.000 ODM X 8 TPI)  
 Also available CSA, BAT, NSS



2-1/2" nozzle with handles



2-1/2" nozzle without handles



1" nozzle

### Blue Refinery Fog Nozzles

**Features**

- Provides consistent volume at any spray angle
- Adjusts from straight stream to fog
- Resistant to petrochemicals

**Specification**

- Maximum operating pressure: **100 PSI** (water only) at **70°F (21°C)**

**Materials**

- Glass-filled
- Blue polycarbonate with bumper and black plastic and steel stem

Size	Thread	90° Spray GPM @ 100 PSI	Polycarbonate Part #
1-1/2"	NPSH	75	RNB150S
	NST (NH)	75	RNB150NST



**N**

### Gaskets

**Application**

- Used on constant flow and refinery fog nozzles

Size	Thread	I.D.	O.D.	Thickness	Nitrile Rubber Part #
1"	NPSH	0.900"	1.270"	0.125"	CFG100S
1-1/2"		1.510"	1.878"	0.125"	CFG150S
2"		1.680"	2.340"	0.156"	CFG200S
1"	NST (NH)	0.900"	1.270"	0.125"	CFG100NST
1-1/2"		1.510"	1.906"	0.125"	CFG150NST
2-1/2"		2.250"	3.000"	0.187"	CFG250NST

NOTE: Dimensions are nominal



### Tri-Flo Fog Nozzles

**Features**

- Corrosion resistant plated aluminum
- Combination 170° fog and straight stream
- Venturi flow improves straight stream and gallonage
- No nozzle teeth eliminates fingers and voids in the spray pattern thus producing a dense fog



Size	Thread	GPM @ 100 PSI Straight Stream	6061 T-6 Aluminum Part #
1-1/2"	NST	60-100-140	TFN150NST-140
	NPSH		TFN150-140
	NST	75-150-200	TFN150NST-200
	NPSH		TFN150-200

### Econo Fog Nozzles

**Application**

- For cabinet use; discourages theft



**Features**

- Rugged, lightweight, corrosion resistant
- Supplied without bumper

**Specification**

- For use up to 100 PSI (water only)

Size	Thread	Straight Stream @ 100 PSI	6061-T6 Aluminum Part #
1"	NPSH	56	AFN100
	NST		AFN100NST
1-1/2"	NPSH		AFN150
	NST		AFN150NST

### Heavy Duty Constant Flow Fog Nozzles



Size	Thread	Length	GPM @ 100 PSI	Fiberglass Reinforced Composite Part #
1-1/2"	NPSH	5"	95	CFFR150
	NST (NH)			CFFR150NST

### Garden Hose Nozzles

**Features**

- Offers two straight streams and one fog pattern<sup>1</sup>
- Massive bumper specially formulated to resist damage and aging
- Corrosion resistant hard coat



GHN75



GHN75-B

Size	Thread	GPM @ 40 PSI Straight Stream		6061-T6 Aluminum Part #
		1st	2nd	
3/4"	GHT - without bumper	1-2	3-4	GHN75
	GHT - with bumper			GHN75-B

<sup>1</sup> Fog pattern is 4-5 GPM @ 40 PSI

### Break Apart Attack Nozzles

**Application**

- Low-cost, versatile, and easy-to-use nozzle for first responders in rural and suburban fire departments

**Features**

- Minimal training required to connect and operate the nozzle
- Nozzle can be separated from the shut off valve for extended hose lays and other uses

**Specification**

- Nozzle uses a 1-1/2" coupler, provides **20-90 GPM** fog or straight-stream flows at **100 PSI**

**Approval**

- Meets or exceeds USDA Forestry Service standards



Size	Thread	Aluminum Part #
1"	NPSH	ABN100S
	NST (NH)	ABN100F
1-1/2"	NPSH	ABN150S
	NST (NH)	ABN150F

### Ball Shut-Off Nozzles - Bolted Style

**Features**

- Rugged and lightweight
- Pistol grip
- Hardcoated female swivel inlet and male outlet

**Specification**

- Maximum operating pressure: **200 PSI** (water only) at **70°F (21°C)**

Size	Thread	Waterway	Cast Aluminum Part #
1-1/2"	NST (NH)	1-3/8"	ACPSO150F
	NPSH		ACPSO150



### Pistol Grip Adapters

**Application**

- Converts any standard fog nozzle to a well-balanced, easy-to-hold pistol grip fog nozzle, making the job of holding high pressure lines easier

**Features**

- Full-time ball bearing swivel base
- Corrosion resistant

**Approval**

- Hardcoated per MIL-A-8625-F TYPE 111 (Polylube 1)

Size	Thread	6061 T-6 Aluminum Part #
1"	NST	PGA100NST
1-1/2"	NST	PGA150NST
	NPSH	PGA150NPSH
2-1/2"	NST	PGA250NST



### Single Gallonage Shut-off Nozzles

**Size**

- 1-1/16" waterway

**Features**

- Lightweight and easily maneuvered
- Full-time ball bearing swivel base

**Materials**

- PTFE hard-coated for greater corrosion resistance and durability
- Metal ball with non-stick Delrin® seats



Size	Thread	Constant GPM @ 100 PSI	Aluminum Part #
1"	NST	95	BVSO100NST
	NPSH		BVSO100
1-1/2"	NST	125	BVSO150NST
	NPSH		BVSO150
	NST		BVSO150NST-125
	NPSH		BVSO150-125

### Dual Gallonage Shut-off Nozzles

**Size**

- 1-1/16" waterway

**Features**

- Lightweight and easily maneuvered
- Full-time ball bearing swivel base

**Materials**

- PTFE hard-coated for greater corrosion resistance and durability
- Metal ball with non-stick Delrin® seats



Size	Thread	Constant GPM @ 100 PSI	Aluminum Part #
1"	NST	25 - 70	---
	NPSH		BVDSO100
1-1/2"	NST		BVDSO150NST
	NPSH		BVDSO150

### Adjustable Tri-Flo Selectable Gallonage Nozzles

**Features**

- Full-time ball bearing swivel base
- Dense fog delivery with no voids or fingers in pattern

**Materials**

- Corrosion resistant plated with Neoprene bumper
- Metal ball with non-stick Delrin® seats



Size	Thread	Constant GPM @ 100 PSI	Aluminum Part #
1-1/2"	NST	60 - 100 - 140	BVTSO150NST
	NPSH		BVTSO150
	NST	75 - 150 - 200	BVTSO150NST-200
	NPSH		BVTSO150-200
2-1/2"	NST	100 - 200 - 300	BVTSO250NST

### Global Forestry Fog Nozzles



Size	Thread	GPM @ 100 PSI Straight Stream		Anodized Aluminum Part #
		1st	2nd	
1-1/2"	NPSH	23.8	73.9	GFN150
	NST (NH)	37.6	95.0	GFN150NST

N



### Forestry Fog Nozzles

**Features**

- Maroon hard-coated barrel allows for easy identification
- Corrosion resistant plated
- Dual flow rate nozzles offer two straight stream and two fog patterns
- Combination fog and straight stream

**Specification**

- Maximum operating pressure: **600 PSI** (water only) at **70°F (21°C)**

Size	Thread	GPM @ 100 PSI Straight Stream		6061-T6 Aluminum Part #
		1st	2nd	
3/4"	GHT	1-2	3-4 <sup>1</sup>	FFN75GHT <sup>1</sup>
1"	NPSH	12	25	FFN100 <sup>2,4</sup>
1-1/2"	NPSH	25	70	FFN150
1"	NST (NH)	12	25	FFN100NST
1-1/2"	NST (NH)	25	70	FFN150NST <sup>3,4</sup>



FFN75GHT



FFN100

<sup>1</sup> GPM @ 40 PSI

<sup>2</sup> FFN100 meets USFS 5100-239A and NSN 4210-01-165-6603

<sup>3</sup> FFN150NST meets USFS 5100-107A and NSN 4210-01-167-1123

<sup>4</sup> both nozzles conform to Forestry Service specification 5100-239C and 5100-107a

### Forestry Grade Ball Shutoff Nozzles

**Feature**

- Hardcoated threads, acetal ball, and rigid inlet

**Approvals**

- NFPA1964 compliant
- FSS specification 5100-238

**Specification**

- Maximum operating pressure: **600 PSI** at ambient temperature **70°F (21°C)**

Size	Thread	Waterway	Anodized Aluminum Part #
1"	NPSH	3/4"	FBSO100S
1-1/2"		1"	FBSO150S
1"	NST (NH)	3/4"	FBSO100F
1-1/2"		1"	FBSO150F



### Forestry Grade Ball Shutoff Pistol Grips

**Features**

- Hardcoated threads, acetal ball, and full time live swivel inlet

**Approvals**

- NFPA1964 compliant
- FSS specification 5100-238

**Specification**

- Maximum operating pressure: **600 PSI** at ambient temperature **70°F (21°C)**

Size	Thread	Waterway	Anodized Aluminum Part #
1"	NPSH	3/4"	FBSO100S-PG
1-1/2"		1"	FBSO150S-PG
1"	NST (NH)	3/4"	FBSO100F-PG
1-1/2"		1"	FBSO150F-PG



### Ball Shutoff Nozzle Tips

**Size**

- 1/2" orifice standard; other sizes available, contact Dixon®

**Feature**

- Lightweight

**Specification**

- Maximum operating pressure: **200 PSI** (water only) at ambient temperature **70°F (21°C)**

Size	Thread	Length	Orifice	Anodized Aluminum Part #
1"	NPSH	4"	1/2"	ANT100
1-1/2"		4-3/4"		ANT150
1"	NST (NH)	4"		ANT100F
1-1/2"		4-3/4"		ANT150F



NPSH



NST

NOTE: Gaskets are special order, please call 877.712.6179 for assistance.

### Penetrator Nozzles



**Feature**

- 1/4" discharge orifice generates a high velocity water jet that is effective against deep seated wildland fires

**Specifications**

- Maximum operating pressure: **200 PSI** (water only) at ambient temperature **70°F (21°C)**
- Designed with standard 1-1/2" NPSH male hose threads that are converted to female thread for connection to the hose using a double female rigid connector

Size	Thread	Length	Orifice	Polycarbonate Part #
1-1/2"	NPSH	5-1/2"	1/4"	PFN4005S
	NST (NH)			PFN4005F

### Twin Tip Straight Stream Forestry Nozzles



**Size**

- Solid, one-piece reversible twin tip has 1/4" and 3/8" orifices

**Material**

- Molded, high-strength red polycarbonate

**Specification**

- Maximum operating pressure: **100 PSI** (water only) at ambient temperature **70°F (21°C)**

Size	Thread	Length with tip	Length without tip	Orifice of base nozzle	Polycarbonate Part #
1-1/2"	NPSH	9"	7-1/2"	1/2"	PTTF150S
	NST (NH)				PTTF150F

### Ball Shut-Off with Nozzle



FNPSO150F-30

FNPSO150S-30

**Features**

- Flexible design allows nozzle tip to be detached so a mating foam inductor can be inserted between the tip and shut-off valve
- Lightweight
- Black pistol grip shutoff with nozzle

**Specification**

- Maximum operating pressure: **150 PSI** (water or AFFF only) at **70°F (21°C)**

Size	Body Color	Thread	GPM	Polycarbonate Part #
1-1/2"	red	NPSH	30	FNPSO150S-30
	orange	NST (NH)		FNPSO150F-30
1-1/2"	red	NPSH	70	FNPSO150S-70
	orange	NST (NH)		FNPSO150F-70

### Ball Shut-Off Pistol Grips



**Feature**

- Lightweight

**Specification**

- Maximum operating pressure: **150 PSI** (water or AFFF only) at ambient temperature **70°F (21°C)**

Size	Thread	Polycarbonate Part #
1-1/2"	NPSH	PPSO150S
	NST (NH)	PPSO150F

N

### Viper® Forestry Nozzles

**Features**

- 1.5" ball shutoff nozzle
- Forestry nozzle
- Swiveled female inlet

**Materials**

- Constructed of hard anodized aluminum
- Handle is made of composite material

**Specification**

- Maximum working pressure **100 PSI**

Size	Thread	Anodized Aluminum Part #
1"	NST (NH)	DVB1560F
	NPSH	DVB1560S
1-1/2"	NST (NH)	DVB3012F
	NPSH	DVB3012S



### Dual Range Nozzle/Tips

**Application**

- Ideal for forestry, fire fighting, and industrial uses

**Features**

- Adjustable from fog, to straight, or off with twist shut off
- Heavy duty rubber bumper

**Material**

- Dual flow nozzles are constructed of hard anodized aluminum and stainless steel internal components

**Specification**

- Maximum working pressure **100 PSI**

Size	Thread	GPM @ 100 PSI	Anodized Aluminum Part #
1"	NST without bumper	10 - 23	D11023BLF
	NPSH without bumper		D11023BLS
	NST with bumper		DB11023F
	NPSH with bumper		DB11023S
1.5"	NST	20 - 60	D156020F
	NPSH		D156020S



### Blue Devil® Select Gallonage Nozzle

**Features**

- Rylostatic teeth directly machined to the nozzle
- Four gallonage selection rings **5, 10, 25, and 50 GPM** and flush without pattern change

**Specification**

- Maximum working pressure **100 PSI**

**Approval**

- NFPA 1964 Compliant

Size	Thread	GPM @ 100 PSI	Part #
1"	NST	5 - 50	DBD550F
	NPSH		DBD550S
	NST	15 - 60	DBD1560F
	NPSH		DBD1560S





### Viper® Select Gallonage Nozzle

**Feature**

- Four gallonage selection rings **30, 60, 90, and 125 GPM**

**Materials**

- Constructed of E-Lite® aluminum and brass internals

**Specification**

- Maximum working pressure **100 PSI**

Size	Thread	GPM @ 100 PSI	Part #
1-1/2"	NST	30 - 125	DSG3012F
	NPSH		DSG3012S



**Feature**

- Four gallonage selection rings **15, 30, 50, and 60 GPM**

Size	Thread	GPM @ 100 PSI	Part #
1-1/2"	NST	15 - 60	DSG1560F
	NPSH		DSG1560S



### Viper Select Gallonage Low Flow Nozzle

**Features**

- Four gallonage selection rings **5, 10, 25, and 40 GPM**
- Available without pistol grip

**Materials**

- Constructed of E-Lite aluminum and brass internals

**Specification**

- Maximum working pressure **100 PSI**

Size	Thread	GPM @ 100 PSI	Part #
1"	NST	5 - 40	DSG540F
	NPSH		DSG540S



N



### Viper Constant Gallonage Nozzle

**Features**

- Fulltime swivels and spinning teeth
- BIMATIC flush system allows flush without shutting down
- Removeable pistol grip

**Materials**

- Constructed of E-Lite aluminum and brass internals

**Specification**

- Maximum working pressure **100 PSI**

Size	Thread	GPM @ 100 PSI	Part #
1-1/2"	NST	60 - 95	DCG2510F
	NPSH		DCG2510S
2-1/2"	NST	150 - 200	DCG8020F
	NPSH		DCG8020S



### Double Female Hex Adapters

**Feature**

- Other configurations are available; consult Dixon® for information

Female Thread	Female NST (NH) Thread	Cast Brass Part #
1-1/2" NPT	1-1/2"	FFH1515F
2-1/2" NPT	2-1/2"	FFH2525F
1-1/2" NST (NH)	1-1/2"	FFH15F15F
2-1/2" NST (NH)	2-1/2"	FFH25F25F

Female Thread	Female NYFD	Cast Brass Part #
1-1/2" NYFD	1-1/2"	FFH15NYFD15NYFD
1-1/2" NPT	1-1/2"	FFH1515NYFD
2-1/2" NPT	2-1/2"	FFH2525NYFD

Female Thread	Female Thread	Cast Brass Part #
1-1/2" NPT	1-1/2" NPSH	FFH15T15S



### Female Rocker Lug - Suction Adapters with Poly Screen

**Feature**

- Suction intake with strainer screen

Female NST (NH) Thread	Female NPT Thread	Cast Brass Part #
2-1/2"	1-1/2"	RSFSA25F15T
	2"	RSFSA25F20T
	2-1/2"	RSFSA250F
	3"	RSFSA25F30T



NOTE: All adapters are made to approved Dixon specifications.  
 NOTE: Replacement washers can be found on page 814

**(Open Snoot) Female Swivel Adapters - Pin Lug**

**Feature**

- Other configurations are available; consult Dixon® for information
- Finishes: -P polished, -C polished chrome plated

**Specification**

- Double female rigid hexagon to swivel connection, rigid end thread is always NPT, hose thread is on swivel end



Female Swivel Thread	Female Rigid Thread	Cast Brass Part #
1-1/2" NST (NH)	1-1/2" NPT	SF150F
1-1/2" NPSH		SF150S
2-1/2" NST (NH)	2" NPT	SF25F15T
2-1/2" NYFD		SF25F20T
2-1/2" NST (NH)	2-1/2" NPT	SF250NYFD
2-1/2" NPSH		SF250F
2-1/2" NST (NH)		SF250F-P
2-1/2" NST (NH)	3" NPT	SF250F-C
3" NST (NH)		SF250S
3" NYFD		SF25F30T
3" NST (NH)	4" NPT	SF300F
3" NYFD		SF300NYFD
4" NST (NH)		SF400F

**Domestic Female Swivel Adapters - Pin Lug**

**Feature**

- Other configurations are available; consult Dixon for information



Female NST (NH) Swivel Thread	Female Rigid NPT Thread	Cast Brass Part #
1-1/2"	1-1/2"	SF150F-D
2-1/2"	2-1/2"	SF250F-D
	2"	SF25F20T-D

**(Open Snoot) Female Swivel Adapters - Rocker Lug**

**Feature**

- Other configurations are available, consult Dixon for information



Female NST (NH) Thread	Female Rigid NPT Thread	Cast Brass Part #
1-1/2"	1-1/2"	RSF150F
2-1/2"	1-1/2"	RSF25F15T
	2"	RSF25F20T
	2-1/2"	RSF250F
	3"	RSF25F30T

NOTE: All adapters are made to approved Dixon specifications.  
 NOTE: Replacement washers can be found on page 814

**Double Female Swivels  
Pin Lug**

Female NPSH Thread	Female NPSH Thread	Cast Brass Part #
1-1/2"	1-1/2"	DFP1515
2-1/2"	2-1/2"	DFP2525

Female NST (NH) Thread	Female NST (NH) Thread	Cast Brass Part #
1-1/2"	1-1/2"	DFP1515F
2-1/2"	2-1/2"	DFP2525F

Female NST (NH) Thread	Female NPSH Thread	Cast Brass Part #
1-1/2"	1-1/2"	DFP15F15S
2-1/2"	2-1/2"	DFP25F25S

Female NYFD Thread	Female NYFD Thread	Cast Brass Part #
1-1/2"	1-1/2"	DFP15NYFD15NYFD
2-1/2"	2-1/2"	DFP25NYFD25NYFD



**Rocker Lug**

Female NPSH Thread	Female NPSH Thread	Cast Brass Part #
1-1/2"	1-1/2"	DFR1515
2-1/2"	2-1/2"	DFR2525

Female NST (NH) Thread	Female NST (NH) Thread	Cast Brass Part #
1-1/2"	1-1/2"	DFR1515F
2-1/2"	2-1/2"	DFR2525F



**N**

**Domestic Double Female Swivels - Pin Lug**

Female NST (NH) Thread	Female NST (NH) Thread	Cast Brass Part #
1-1/2"	1-1/2"	DFP1515F-D
2-1/2"	2-1/2"	DFP2525F-D



NOTE: Replacement washers can be found on page 814

**Swivel Female x Rigid Female Adapters - Rocker Lug  
Style N53**



Female NPSH Swivel Thread	Female Rigid NPT Thread	Aluminum Extrusion - Anodized Part #
1-1/2"	1-1/2"	N53-15S15T
2"	2"	N53-20S20T
3"	3"	N53-30S30T
6"	6"	N53-60S60T



Female NPSH Swivel Thread	Female Rigid NPSH Thread	Aluminum Extrusion - Anodized Part #
1-1/2"	1-1/2"	N53-15S15S



Female NST (NH) Swivel Thread	Female Rigid NPT Thread	Aluminum Extrusion - Anodized Part #
1-1/2"	1-1/2"	N53-15F15T
2-1/2"	2"	N53-25F20T
	2-1/2"	N53-25F25T
	3"	N53-25F30T
	4"	N53-25F40T
4"	4"	N53-40F40T
4-1/2"	4"	N53-45F40T
	6"	N53-45F60T
5"	6"	N53-50F60T
6"	6"	N53-60F60T

N



Female NST (NH) Swivel Thread	Female Rigid NST Thread	Aluminum Extrusion - Anodized Part #
1-1/2"	1-1/2"	N53-15F15F
2-1/2"	1-1/2"	N53-25F15F
	2-1/2"	N53-25F25F
	6"	N53-25F60F
4"	4"	N53-40F40F
6"	4-1/2"	N53-60F45F

NOTE: All adapters are made to approved Dixon® specifications.  
NOTE: Replacement washers can be found on page 814



### Double Swivel Female Adapters - Rocker Lug Style N35

Female NPSH Swivel Thread	Female NPSH Swivel Thread	Aluminum Extrusion - Anodized Part #
1"	1"	N35-10S10S
1-1/2"	1-1/2"	N35-15S15S
2-1/2"	2-1/2"	N35-25S25S
3"	3"	N35-30S30S



Female NST (NH) Swivel Thread	Female NST (NH) Swivel Thread	Aluminum Extrusion - Anodized Part #
1"	1"	N35-10F10F
1-1/2"	1-1/2"	N35-15F15F
	2-1/2"	N35-15F25F
2-1/2"	2-1/2"	N35-25F25F
4"	4"	N35-40F40F
4-1/2"	4-1/2"	N35-45F45F
5"	5"	N35-50F50F
6"	6"	N35-60F60F



Female NPSH Swivel Thread	Female NST Swivel Thread	Aluminum Extrusion - Anodized Part #
1"	1"	N35-10S10F
	1-1/2"	N35-10S15F
1-1/2"	1-1/2"	N35-15S15F
2"	2-1/2"	N35-20S25F
2-1/2"	2-1/2"	N35-25S25F



### Double Female Swivel Adapters - Long Handle Style N57

Female NST (NH) Thread	Male NST (NH) Thread	Aluminum Extrusion - Anodized Part #
4-1/2"	6"	N57-45F60F
5"	5"	N57-50F50F
	6"	N57-50F60F
6"	6"	N57-60F60F



NOTE: All adapters are made to approved Dixon® specifications.  
 NOTE: Replacement washers can be found on page 814

### Hydrant Adapters - Pin Lug

**Feature**

- Other configurations are also available, consult Dixon® for information



reducer



same size



increaser

Female Thread	Male Thread	Cast Brass Part #	
1-1/2" NPSH	3/4" GHT	HA15S76	
	3/4" NPSH	HA15S75	
	3/4" NPT	HA15S75T	
	1" NPSH	HA15S10S	
	1" NPT	HA15S10T	
	1-1/2" NPT	HA15S15T	
	1-1/2" NST (NH)	HA15S15F	
1-1/2" NPT	1-1/2" NPSH	HA15T15S	
	1-1/2" NST (NH)	HA15T15F	
1-1/2" NST (NH)	3/4" GHT	HA1576	
	3/4" NPSH	HA1575	
	3/4" NPT	HA1575T	
	1" NPSH	HA1510	
	1" NST (NH)	HA1510F	
	1" NPT	HA1510T	
	1-1/2" NPSH	HA1515	
	1-1/2" NPT	HA1515T	
	1-1/2" NST (NH)	HA1515F	
	2-1/2" NST (NH)	HA1525F	
2" NPSH	1-1/2" NPSH	HA20S15S	
	1-1/2" NPT	HA20S15T	
	1-1/2" NST (NH)	HA20S15F	
	2-1/2" NST (NH)	HA20S25F	
2" NPT	2-1/2" NST (NH)	HA20T25F	
2" NST (NH)	2-1/2" NST (NH)	HA2025F	
	1" NPT	HA25S10T	
	1-1/2" NPSH	HA25S15S	
	1-1/2" NPT	HA25S15T	
2-1/2" NPSH	1-1/2" NST (NH)	HA25S15F	
	2-1/2" NST (NH)	HA25S25F	
	3/4" GHT	HA2576	
	3/4" NPT	HA2575T	
	1" NPSH	HA2510	
	1" NST (NH)	HA2510F	
	1" NPT	HA2510T	
	1-1/2" NPSH	HA2515	
	1-1/2" NST (NH)	HA2515F	
	1-1/2" NPT	HA2515T	
2-1/2" NST (NH)	2" NPSH	HA2520	
	2" NST (NH)	HA2520F	
	2" NPT	HA2520T	
	2-1/2" NPSH	HA2525	
	2-1/2" NST (NH)	HA2525F	
	2-1/2" NPT	HA2525T	
	3" NPSH	HA2530	
	3" NST (NH)	HA2530F	
	3" NPT	HA2530T	
	3" NPSH	2-1/2" NST (NH)	HA30S25F
		2-1/2" NPT	HA30S25T
	3" NST (NH)	1-1/2" NPSH	HA3015S
		1-1/2" NST (NH)	HA3015F
2-1/2" NST (NH)		HA3025F	
4" NST (NH)	2-1/2" NST (NH)	HA4025F	
4-1/2" NST (NH)	2-1/2" NST (NH)	HA4525F	

NOTE: All adapters are made to approved Dixon specifications.

NOTE: Replacement washers can be found on page 814

N

### Hydrant Adapters - Rocker Lug

**Feature**

- Other configurations are also available, consult Dixon® for information
- Finishes: -C polished chrome plated

Female Thread	Male Thread	Cast Brass Part #
1-1/2" NST (NH)	3/4" NST (NH)	RHA1576
	1" NST (NH)	RHA1510
	1" NST (NH)	RHA1510F
	1" NPT	RHA1510T
	1-1/2" NPSH	RHA1515
	1-1/2" NST (NH)	RHA1515F
	1-1/2" NPT	RHA1515T
	2" NPSH	RHA1520
1-1/2" NPSH	2-1/2" NST (NH)	RHA1525F
	3/4" NPT	RHA15S75T
	1" NPSH	RHA15S10
	1" NPT	RHA15S10T
	1-1/2" NST (NH)	RHA15S15F
1-1/2" NPT	1-1/2" NPT	RHA15S15T
	1-1/2" NST (NH)	RHA15T15F
2" NST (NH)	2-1/2" NST (NH)	RHA2025F
2-1/2" NST (NH)	3/4" GHT	RHA2576
	1" NPSH	RHA2510
	1" NST (NH)	RHA2510F
	1" NPT	RHA2510T
	1-1/2" NPSH	RHA2515
	1-1/2" NST (NH)	RHA2515F
	1-1/2" NPT	RHA2515T
	2" NST (NH)	RHA2520F
	2" NPT	RHA2520T
	2-1/2" NPT	RHA2525T
2-1/2" NPSH	3" NPT	RHA2530T
	1-1/2" NPSH	RHA25S15
	1-1/2" NST (NH)	RHA25S15F
2-1/2" NPT	2-1/2" NST (NH)	RHA25T25F
3" NST (NH)	2-1/2" NST (NH)	RHA3025F



reducer



reducer - chrome plated



same size

### Female x Male Adapters - Long Handle Style N56

Female NST (NH) Thread	Male NST (NH) Thread	Aluminum Extrusion - Anodized Part #
4"	2-1/2"	N56-40F25F
4-1/2"	4"	N56-45F40F
5"	2-1/2"	N56-50F25F
6"	4-1/2"	N56-60F45F
	6"	N56-60F60T <sup>1</sup>



<sup>1</sup> Female NST (NH) x male NPT

NOTE: All adapters are made to approved Dixon specifications.  
 NOTE: Replacement washers can be found on page 814



### Hydrant Adapters - Pin Lugs (New York Threads)



reducer



same size



increaser

**Feature**

- Other configurations are also available, consult Dixon® for information

**Specifications**

- NYFD thread = 3.031 x 8 TPI
- NYC thread = 3.00 x 8 TPI

Female NYFD Thread	Male Thread	Cast Brass Part #
1-1/2"	3/4" GHT	HA15NYFD76
	3/4" NPT	HA25NYFD75T
2-1/2"	3/4" GHT	HA25NYFD76
	1-1/2" NPSH	HA25NYFD15S
	1-1/2" NST (NH)	HA25NYFD15F
	1-1/2" NPT	HA25NYFD15T
	1-1/2" NYFD	HA25NYFD15NYFD
	2" NPT	HA25NYFD20T
<hr/>		
Female NYC Thread	Male Thread	Cast Brass Part #
2-1/2"	3/4" GHT	HA25NYC76
	1" NPT	HA25NYC10T
	1-1/2" NPT	HA25NYC15T
	2" NPT	HA25NYC20T

### Hazmat Adapters - Pin Lugs

**Feature**

- Divides single stream into double stream

Female NST Thread	Male Thread	Cast Brass Part #
1-1/2"	(2) 3/4" GHT	HHA1576
2-1/2"		HHA2576

### Domestic Hydrant Adapters - Pin Lug

**Feature**

- Other configurations are available, consult Dixon for information



Female NST (NH) Thread	Male Thread	Cast Brass Part #
1-1/2"	3/4" GHT	HA1576-D
2-1/2"	1" NPT	HA2510T-D
	1/12" NST (NH)	HA2515F-D
	1-1/2" NPT	HA2515T-D
	3/4" GHT	HA2576-D

NOTE: All adapters are made to approved Dixon specifications.  
NOTE: Replacement washers can be found on page 814

N

### Hydrant Adapters - Rocker Lug

**Application**

- Use with water

**Specification**

- Maximum working pressure: 100 PSI at 70°F (21°C)

Female Thread	Male Thread	Polycarbonate Part #
1-1/2" NPSH	1-1/2" NST (NH)	POLYHA15S15F
2-1/2" NST (NH)	3/4" GHT	POLYHA2576
	1-1/2" NPSH	POLYHA2515
	1-1/2" NST (NH)	POLYHA2515F
	2" NPT	POLYHA2520T



### Domestic Female to Male Hex Nipples

**Feature**

- Other configurations are available, consult Dixon® for information

Female Thread	Male Thread	Cast Brass Part #
1" NPT	1-1/2" NST (NH)	FM1015F-D
1-1/2" NPT	1-1/2" NST (NH)	FM1515F-D
	2-1/2" NST (NH)	FM1525F-D
1-1/2" NST (NH)	1-1/2" NPSH	FM15F15S-D
	1-1/2" NPT	FM15F15T-D
	2-1/2" NST (NH)	FM15F25F-D
1-1/2" NPSH	1-1/2" NST (NH)	FM15S15F-D
	1-1/2" NPT	FM15S15T-D
2" NPT	1-1/2" NST (NH)	FM2015F-D
2-1/2" NPT	2-1/2" NST (NH)	FM2525F-D
2-1/2" NST (NH)	1-1/2" NST (NH)	FM25F15F-D
	1-1/2" NPT	FM25F15T-D
	2-1/2" NPT	FM25F25T-D



reducer



same size



increaser



NOTE: All adapters are made to approved Dixon® specifications.  
 NOTE: Replacement washers can be found on page 814

### Single Male Outlet with Hex (open snoot)

**Application**

- Used to connect fire hose to a standpipe or sprinkler system

**Features**

- Other sizes, threads, and configurations are available, consult Dixon® for information
- Finishes: -P polished, -C polished chrome plated



polished



polished chrome plated

Female NPT Thread	Male Thread	Cast Brass Part #
2-1/2"	2-1/2" NST (NH)	MOC250F-P
		MOC250F-C
3"	2-1/2" NST (NH)	MOC3025F-P
	3" NST (NH)	MOC3025F-C
		MOC300F-P

Female NPT Thread	Male Thread	Cast Brass Part #
2-1/2"	2-1/2" NYC	MOC250NYC-P
	2-1/2" NYFD	MOC250NYFD-P

### Female to Male Hex Nipples

**Feature**

- Other configurations are also available, consult Dixon for information

Female Thread	Male Thread	Cast Brass Part #
3/4 GHT	1" NPT	FM7610T
1" NPSH	3/4" GHT	FM10S76
1" NPT	3/4" GHT	FM1076
	1" NPSH	FM1010
	1" NST (NH)	FM1010F
	1-1/2" NPSH	FM1015
1" NST (NH)	1-1/2" NST (NH)	FM1015F
	1" NPT	FM10F10T
1-1/2" NPT	1-1/2" NPSH	FM1515
	1-1/2" NST (NH)	FM1515F
	2-1/2" NST (NH)	FM1525F
1-1/2" NST (NH)	1-1/2" NPSH	FM15F15S
	1-1/2" NPT	FM15F15T
	2" NPT	FM15F20T
	2-1/2" NPT	FM15F25T
	2-1/2" NST (NH)	FM15F25F
	1-1/2" NST (NH)	FM15F15F
1-1/2" NPSH	1-1/2" NST (NH)	FM15S15F
	1-1/2" NPT	FM15S15T
	2" NPT	FM15S20T
2" NPSH	1-1/2" NPSH	FM20S15
	1-1/2" NST (NH)	FM20S15F
	1-1/2" NPT	FM20S15T
	2" NPT	FM20S20T
2" NPT	2-1/2" NST (NH)	FM20S25F
	1-1/2" NPSH	FM2015
	1-1/2" NST (NH)	FM2015F
	2" NPSH	FM2020
	2-1/2" NST (NH)	FM2025F
2-1/2" NST (NH)	3/4" NPT	FM25F75T
	1" NPT	FM25F10T
	1-1/2" NST (NH)	FM25F15F
	1-1/2" NPT	FM25F15T
	2" NPT	FM25F20T
2-1/2" NPT	1-1/2" NST (NH)	FM2515F
	2-1/2" NPSH	FM2525
	2-1/2" NST (NH)	FM2525F

Table continued on next page

NOTE: All adapters are made to approved Dixon specifications.

NOTE: Replacement washers can be found on page 814

N



reducer



same size

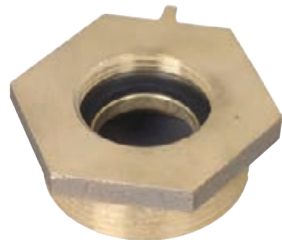

increaser

### Female to Male Hex Nipples

Table continued from previous page

Female Thread	Male Thread	Cast Brass Part #
2-1/2" NST (NH)	2-1/2" NST (NH)	FM25F25F
	2-1/2" NPT	FM25F25T
	3" NST (NH)	FM25F30F
	3" NPT	FM25F30T
2-1/2" NPSH	2-1/2" NPSH	FM25F25S
2-1/2" NPT	2-1/2" NPT	FM2525T
2-1/2" NPSH	2-1/2" NST (NH)	FM25S25F
	2-1/2" NPT	FM25S25T
3" NPT	2-1/2" NST (NH)	FM3025F
	2-1/2" NPT	FM3025T
	3" NST (NH)	FM3030F
3" NST (NH)	2-1/2" NST (NH)	FM30F25F
	2-1/2" NPT	FM30F25T
	3" NPT	FM30F30T
3" NPSH	2-1/2" NST (NH)	FM30S25F
4" NPT	2-1/2" NST (NH)	FM4025F
	4" NST (NH)	FM4040F
	4-1/2" NST (NH)	FM4045F
4" NST (NH)	4" NPT	FM40F40T
4-1/2" NST (NH)	4" NPT	FM45F40T
6" NPT	6" NST (NH)	FM6060F
6" NST (NH)	6" NPT	FM60F60T



reducer



same size

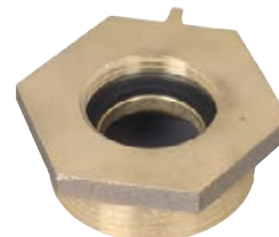

increaser

### Female to Male Hex Nipples (New York Threads)

**Feature**

- Other configurations are available, consult Dixon® for information

**Specifications**

- NYFD thread = 3.031 x 8 TPI
- NYC thread = 3.00 x 8 TPI

Female Thread	Male Thread	Cast Brass Part #
1-1/2" NPT	1-1/2" NYFD	FM1515NYFD
1-1/2" NST (NH)	1-1/2" NYFD	FM15F15NYFD
1-1/2" NYFD	1-1/2" NST (NH)	FM15NYFD15F
	1-1/2" NPT	FM15NYFD15T

Female Thread	Male Thread	Cast Brass Part #
2-1/2" NPT	2-1/2" NYC	FM2525NYC
	2-1/2" NYFD	FM2525NYFD
2-1/2" NST (NH)	2-1/2" NYC	FM25F25NYC
	2-1/2" NYFD	FM25F25NYFD
2-1/2" NYC	2-1/2" NST (NH)	FM25NYC25F
	2-1/2" NPT	FM25NYC25T
2-1/2" NYFD	2-1/2" NST (NH)	FM25NYFD25F
	2-1/2" NPT	FM25NYFD25T

Female NYFD Thread	Male Thread	Cast Brass Part #
2-1/2"	1-1/2" NPT	FM25NYFD15T
	2" NPT	FM25NYFD20T
	3" NPT	FM25NYFD30T



reducer



same size

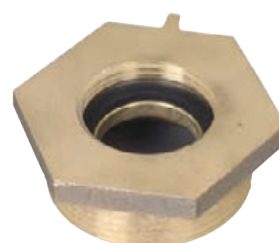

increaser



NOTE: All adapters are made to approved Dixon specifications.  
NOTE: Replacement washers can be found on page 814

**Female x Male Adapters - Rocker Lug  
Style N37**



reducer



same size



increaser

Female Thread	Male Thread	Aluminum Extrusion - Anodized Part #
3/4" GHT	1" NST (NH)	N37-07G10F
	1" NPSH	N37-07G10S
	1" NPT	N37-07G10T
	1-1/2" NST (NH)	N37-07G15F
	1-1/2" NPSH	N37-07G15S
1" NST	3/4" GHT	N37-10F07G
	1" NPSH	N37-10F10S
	1" NPT	N37-10F10T
	1-1/2" NST (NH)	N37-10F15F
	1-1/2" NPSH	N37-10F15S
1" NPSH	2-1/2" NST (NH)	N37-10F25F
	3/4" GHT	N37-10S07G
	3/4" NPSH	N37-10S07S
	1" NST (NH)	N37-10S10F
	1" NPT	N37-10S10T
1" NPT	1-1/2" NST (NH)	N37-10S15F
	1-1/2" NPSH	N37-10S15S
	1" NST	N37-10T10F
	3/4" GHT	N37-15F07G
	3/4" NPT	N37-15F07T
1-1/2" NST (NH)	1" NST (NH)	N37-15F10F
	1" NPSH	N37-15F10S
	1" NPT	N37-15F10T
	1-1/2" NST (NH)	N37-15F15F
	1-1/2" NPSH	N37-15F15S
	1-1/2" NPT	N37-15F15T
	2" NPT	N37-15F20T
	2-1/2" NST (NH)	N37-15F25F
1-1/2" NPSH	3/4" GHT	N37-15S07G
	1" NST (NH)	N37-15S10F
	1-1/2" NST (NH)	N37-15S15F
	1-1/2" NPT	N37-15S15T
1-1/2" NPT	2" NPT	N37-15S20T
	1-1/2" NST (NH)	N37-15T15F
	1-1/2" NPSH	N37-15T15S
	2-1/2" NST (NH)	N37-15T25F
2" NPSH	3/4" GHT	N37-20S07G
	1-1/2" NST (NH)	N37-20S15F
	1-1/2" NPSH	N37-20S15S
	2" NPT	N37-20S20T
2" NPT	2-1/2" NST (NH)	N37-20S25F
	1-1/2" NST (NH)	N37-20T15F
	1-1/2" NPSH	N37-20T15S
	2-1/2" NST (NH)	N37-20T25F

Table continued on next page

NOTE: All adapters are made to approved Dixon® specifications.  
NOTE: Replacement washers can be found on page 814



## Female x Male Adapters - Rocker Lug (continued) Style N37

Table continued from previous page

Female Thread	Male Thread	Aluminum Extrusion - Anodized Part #
2-1/2" NST (NH)	3/4" GHT	N37-25F07G
	3/4" NPT	N37-25F07T
	1" NPT	N37-25F10T
	1-1/2" NST (NH)	N37-25F15F
	1-1/2" NPSH	N37-25F15S
	1-1/2" NPT	N37-25F15T
	2" NPT	N37-25F20T
	2-1/2" NST (NH)	N37-25F25F
	2-1/2" NPSH	N37-25F25S
	2-1/2" NPT	N37-25F25T
	3" NST (NH)	N37-25F30F
	3" NPT	N37-25F30T
2-1/2" NPSH	1-1/2" NPSH	N37-25S15S
	2-1/2" NST (NH)	N37-25S25F
	2-1/2" NPT	N37-25S25T
2-1/2" NPT	1-1/2" NPSH	N37-25T15S
	2-1/2" NST (NH)	N37-25T25F
	3" NPT	N37-25T30T
3" NST (NH)	1-1/2" NST (NH)	N37-30F15F
	2-1/2" NST (NH)	N37-30F25F
	3" NPT	N37-30F30T
3" NPT	2-1/2" NST (NH)	N37-30S25F
	2-1/2" NST (NH)	N37-30T25F
	2-1/2" NPT	N37-30T25T
4" NST (NH)	2-1/2" NST (NH)	N37-40F25F
	4" NST (NH)	N37-40F40F
	4" NPT	N37-40F40T
4" NPT	6" NST (NH)	N37-40F60F
	2-1/2" NST (NH)	N37-40T25F
	4" NST (NH)	N37-40T40F
4-1/2" NST (NH)	4-1/2" NST (NH)	N37-40T45F
	2-1/2" NST (NH)	N37-45F25F
	4" NST (NH)	N37-45F40F
5" NST (NH)	4" NPT	N37-45F40T
	5" NST (NH)	N37-45F50F
	4-1/2" NST (NH)	N37-50F45F
5" NPSH	5" NPT	N37-50F50T
	6" NST (NH)	N37-50F60F
	6" NST (NH)	N37-50S60F
6" NST (NH)	5" NPT	N37-50S60F
	4" NPT	N37-60F40T
	5" NST (NH)	N37-60F50F
6" NPT	6" NPT	N37-60F60T
	4" NST (NH)	N37-60T40F
	6" NST (NH)	N37-60T60F



reducer



same size



increaser



NOTE: All adapters are made to approved Dixon® specifications.  
NOTE: Replacement washers can be found on page 814

**Brass Female Swivel to Male Adapters**

**Pin Lug**

Female NST (NH) Thread	Male NPT Thread	Cast Brass Part #
1-1/2"	1-1/2"	SM150F
2-1/2"	1-1/2"	SM25F15T
	2"	SM25F20T
	2-1/2"	SM250F
	3"	SM25F30T
4"	4"	SM400F



Female NPSH Thread	Male NPT Thread	Cast Brass Part #
1-1/2"	1-1/2"	SM150S
2"	2"	SM200S
2-1/2"	2-1/2"	SM250S

Female Thread	Male NST (NH) Thread	Cast Brass Part #
1-1/2" NPSH	1-1/2"	SM15S15F
2-1/2" NST (NH)	3"	SM25F30F

Female Thread	Male NPT Thread	Cast Brass Part #
1-1/2" NYFD	1-1/2"	SM150NYFD
2-1/2" NYFD	2-1/2"	SM250NYFD

**Rocker Lug**

Female Thread	Male NPT Thread	Cast Brass Part #
1-1/2" NST (NH)	1-1/2"	RSM150F
1-1/2" NPSH		RSM150S
2-1/2" NST (NH)	2"	RSM25F20T
	2-1/2"	RSM250F
	3"	RSM25F30T



**Domestic Male Swivel Adapters - Pin Lug**

Female NST (NH) Swivel Thread	Male NPT Thread	Cast Brass Part #
1-1/2"	1-1/2"	SM150F-D
2-1/2"	2-1/2"	SM250F-D
	2"	SM25F20T-D
	3"	SM25F30T-D



NOTE: All adapters are made to approved Dixon® specifications.  
 NOTE: Replacement washers can be found on page 814

### Male Rocker Lug - Suction with Poly Screen

**Feature**

- Suction intake with strainer screen

Female NST (NH) Thread	Male NPT Thread	Cast Brass Part #
2-1/2"	2"	RSMSA25F20T
	2-1/2"	RSMSA250F
	3"	RSMSA25F30T



### Male Rocker Lug - Suction with Zinc Screen

**Feature**

- Suction intake with zinc strainer screen - excellent to use before backflow preventers

Female NST (NH) Thread	Male NPT Thread	Cast Brass Part #
2-1/2"	2"	RSMSA25F20T-Z
	2-1/2"	RSMSA250F-Z
	3"	RSMSA25F30T-Z



### Male Rocker Lug - Suction with Poly Screen

**Feature**

- Suction intake with strainer screen

Female NST (NH) Thread	Male NPT Thread	Aluminum Part #
2-1/2"	2"	ARSMSA25F20T
	2-1/2"	ARSMSA250F



NOTE: All adapters are made to approved Dixon® specifications.  
 NOTE: Replacement washers can be found on page 814

**Female Swivel to Male Adapters - Rocker Lug  
Style N54**



Female Swivel Thread	Male Rigid Thread	Aluminum Extrusion - Anodized Part #
1-1/2" NST (NH)	1-1/2" NST (NH)	N54-15F15F
	1-1/2" NPT	N54-15F15T
	2-1/2" NST (NH)	N54-15F25F
1-1/2" NPSH	1-1/2" NPSH	N54-15S15S
	1-1/2" NPT	N54-15S15T
2-1/2" NST (NH)	1-1/2" NST (NH)	N54-25F15F
	1-1/2" NPT	N54-25F15T
	2" NPT	N54-25F20T
	2-1/2" NST (NH)	N54-25F25F
	2-1/2" NPT	N54-25F25T
2-1/2" NPSH	2" NPT	N54-25S20T
3" NPSH	3" NPT	N54-30S30T
4" NST (NH)	4" NST (NH)	N54-40F40F
	4" NPT	N54-40F40T
	6" NST (NH)	N54-40F60F
4-1/2" NST (NH)	4" NPT	N54-45F40T
	6" NPT	N54-45F60T
6" NST (NH)	6" NPT	N54-60F60T

**Female Swivel to Male Adapters - Long Handle  
Style N54L**



Female NST Thread	Male Thread	Aluminum Extrusion - Anodized Part #
2-1/2"	2-1/2" NST (NH)	N54L-25F25F
4"	6" NST (NH)	N54L-40F60F
4-1/2"	4" NPT	N54L-45F40T
6"	4" NPT	N54L-60F40T
	5" NST (NH)	N54L-60F50F
	6" NPT	N54L-60F60T

NOTE: All adapters are made to approved Dixon® specifications.  
NOTE: Replacement washers can be found on page 814

## Double Male Hex Nipples

**Feature**

- Other configurations are available, consult Dixon® for information

Male Thread	Male Thread	Cast Brass Part #
3/4" NPT	1-1/2" NPSH	DMH7515
	1-1/2" NST (NH)	DMH7515F
1" NPT	3/4" GHT	DMH1076
	1" NPSH	DMH1010
	1" NST (NH)	DMH1010F
	1-1/2" NPSH	DMH1015
	1-1/2" NST (NH)	DMH1015F
	2-1/2" NST (NH)	DMH1025F
1-1/2" NPSH	1-1/2" NPSH	DMH15S15S
1-1/2" NPT	1" NPSH	DMH1510
	1" NST (NH)	DMH1510F
	1-1/2" NPSH	DMH1515
	1-1/2" NPT	DMH1515T
	1-1/2" NST (NH)	DMH1515F
	2" NPSH	DMH1520
	2-1/2" NST (NH)	DMH1525F
1-1/2" NST (NH)	1-1/2" NPSH	DMH15F15S
	1-1/2" NST (NH)	DMH15F15F
	2-1/2" NST (NH)	DMH15F25F
2" NPT	1-1/2" NPSH	DMH2015
	1-1/2" NST (NH)	DMH2015F
	2" NPSH	DMH2020
	2-1/2" NPSH	DMH2025
	2" NPT	DMH2020T
	2-1/2" NST (NH)	DMH2025F
2-1/2" NPT	1-1/2" NPSH	DMH2515
	1-1/2" NST (NH)	DMH2515F
	2" NPSH	DMH2520
	2-1/2" NPSH	DMH2525
	2-1/2" NST (NH)	DMH2525F
	2-1/2" NPT	DMH2525T
	3" NPSH	DMH2530
	3" NPT	DMH2530T
2-1/2" NST (NH)	2-1/2" NST (NH)	DMH25F25F
	3" NST (NH)	DMH25F30F
3" NPT	2-1/2" NPSH	DMH3025
	2-1/2" NST (NH)	DMH3025F
	3" NPSH	DMH3030
	3" NST (NH)	DMH3030F
4" NPT	3" NPT	DMH3030T
	4" NPSH	DMH4040
4" NST (NH)	4" NST	DMH40F40F
4" NPT	4" NST (NH)	DMH4040F
	4-1/2" NST (NH)	DMH4045F
	4" NPT	DMH4040T
5" NPT	5" NST (NH)	DMH5050F
6" NPT	4-1/2" NST (NH)	DMH6045F
	6" NST (NH)	DMH6060F
	6" NPSH	DMH6060
	6" NPT	DMH6060T



reducer



same size



increaser



NOTE: All adapters are made to approved Dixon specifications.

### Double Male Hex Adapters (NYFD Threads)



reducer



same size



increaser

**Feature**

- Other configurations are available, consult Dixon® for information

Male Thread	Male NYFD Thread	Cast Brass Part #
1-1/2" NPT	1-1/2"	DMH1515NYFD
1-1/2" NST (NH)		DMH15F15NYFD
1-1/2" NPT	2-1/2"	DMH1525NYFD
2" NPT		DMH2025NYFD
2-1/2" NPT	1-1/2"	DMH2515NYFD
	2-1/2"	DMH2525NYFD

Male NST (NH) Thread	Male NYFD Thread	Cast Brass Part #
2-1/2"	2-1/2"	DMH25F25NYFD

Male NYFD Thread	Male NYFD Thread	Cast Brass Part #
1-1/2"	1-1/2"	DMH15NYFD15NYFD
2-1/2"	2-1/2"	DMH25NYFD25NYFD

NOTE: NYFD thread: 3.031 x 8 TPI

### Domestic Double Male Hex Adapters

**Feature**

- Other configurations are available, consult Dixon® for information

Male Thread	Male Thread	Cast Brass Part #
1" NPT	1" NST (NH)	DMH1010F-D
	1-1/2" NST (NH)	DMH1015F-D
1-1/2" NPT	1-1/2" NPSH	DMH1515-D
	1-1/2" NST (NH)	DMH1515F-D
	2-1/2" NST (NH)	DMH1525F-D
1-1/2" NST (NH)	1-1/2" NST (NH)	DMH15F15F-D
	1-1/2" NPSH	DMH15F15S-D
	2-1/2" NST (NH)	DMH15F25F-D
2" NPT	1-1/2" NST (NH)	DMH2015F-D
	2" NPSH	DMH2020-D
	2-1/2" NST (NH)	DMH2025F-D
2-1/2" NPT	1-1/2" NST (NH)	DMH2515F-D
	2-1/2" NST (NH)	DMH2525F-D
2-1/2" NST (NH)	2-1/2" NST (NH)	DMH25F25F-D
3" NPT	2-1/2" NST (NH)	DMH3025F-D
	3" NST (NH)	DMH3030F-D
4" NPT	4-1/2" NST (NH)	DMH4045F-D
6" NPT	6" NST (NH)	DMH6060F-D



reducer



same size



increaser

### Double Male Adapters

**Feature**

- Other configurations are available, consult Dixon for information

**Pin Lug**

Male Thread	Male Thread	Cast Brass Part #
1-1/2" NST (NH)	1-1/2" NST (NH)	DMP1515F
	1-1/2" NPT	DMP15F15T
1-1/2" NPSH	1-1/2" NPSH	DMP1515
	1-1/2" NPT	DMP15S15T
1-1/2" NST (NH)	1-1/2" NPSH	DMP15F15S
	2-1/2" NST (NH)	DMP2525F
2-1/2" NST (NH)	2-1/2" NPSH	DMP25F25S
	2-1/2" NPT	DMP25F25T
	2-1/2" NPSH	DMP2525



**Rocker Lug**

Male Thread	Male Thread	Cast Brass Part #
1-1/2" NST (NH)	1-1/2" NST (NH)	DMR1515F
	1-1/2" NPT	DMR15F15T
	1-1/2" NPSH	DMR15F15S
1-1/2" NPSH	1-1/2" NPSH	DMR1515
	1-1/2" NPT	DMR15S15T
2-1/2" NST (NH)	2-1/2" NST (NH)	DMR2525F
2-1/2" NPSH	2-1/2" NPSH	DMR2525



NOTE: All adapters are made to approved Dixon specifications.

### Double Male Adapters - Rocker Lug Style N36



same size



increaser

Male NST (NH) Thread	Male Thread	Aluminum Extrusion - Anodized Part #
1"	1" NST (NH)	N36-10F10F
1-1/2"	1-1/2" NST (NH)	N36-15F15F
	2" NPT	N36-15F20T
2-1/2"	2-1/2" NST (NH)	N36-15F25F
	2-1/2" NST (NH)	N36-25F25F
	3" NST (NH)	N36-25F30F
	3" NPT	N36-25F30T
	4" NST (NH)	N36-25F40F
3"	4" NPT	N36-25F40T
	4-1/2" NST (NH)	N36-25F45F
3"	3" NST (NH)	N36-30F30F
4"	4" NST (NH)	N36-40F40F
4-1/2"	4-1/2" NST (NH)	N36-45F45F
6"	6" NST (NH)	N36-60F60F

Male NPT Thread	Male Thread	Aluminum Extrusion - Anodized Part #
1-1/2"	1-1/2" NST (NH)	N36-15T15F
	2-1/2" NST (NH)	N36-15T25F
2"	2" NPT	N36-20T20T
	2-1/2" NST (NH)	N36-20T25F
2-1/2"	2-1/2" NST (NH)	N36-25T25F
	3" NPT	N36-25T30T
	4" NPT	N36-25T40T
3"	3" NST (NH)	N36-30T30F
4"	4" NST (NH)	N36-40T40F
	4-1/2" NST (NH)	N36-40T45F
5"	6" NPT	N36-50T60T
6"	6" NST (NH)	N36-60T60F

Male NPSH Thread	Male Thread	Aluminum Extrusion - Anodized Part #
1"	1" NPSH	N36-10S10S
1-1/2"	1-1/2" NST (NH)	N36-15S15F
	1-1/2" NPSH	N36-15S15S
	1-1/2" NPT	N36-15S15T
	2" NPSH	N36-15S20S
2-1/2"	2-1/2" NST (NH)	N36-25S25F
	2-1/2" NPSH	N36-25S25S

### Cam and Groove Hydrant Adapters

**Features**

- Pin lugs allow for easy connection using standard spanner and hydrant wrenches on pages 828 - 831
- Supplied with a nitrile rubber washer in the threaded end



Female NST (NH) Thread	Male Adapter	Brass Part #	Aluminum Part #
1-1/2"	1-1/2"	HA1515ADP	AHA1515ADP
2-1/2"	2-1/2"	HA2525ADP	AHA2525ADP

### Replacement Washers



I.D.	O.D.	Thickness	Nitrile Rubber Part #
1-9/16"	2-1/16"	1/8"	SW150
2-9/16"	3-3/16"	3/16"	SW250

NOTE: All adapters are made to approved Dixon® specifications.





### Cam and Groove x NST

**Features**

- For suction and low pressure discharge only
- Other sizes, configurations, and materials available, contact Dixon® for information

**Material**

- Powder coated aluminum adapter

#### Type A x Female NST (NH)

Adapter Size	Female NST (NH) Thread	Aluminum Part #
1-1/2"	1-1/2"	G150-A-ALNST
2-1/2"	2-1/2"	G250-A-ALNST
3"		3025-A-ALNST



#### Type B x Male NST (NH)

**Material**

- Nitrile rubber seals standard

Coupler Size	Male NST (NH) Thread	Aluminum Part #
1-1/2"	1-1/2"	G150-B-ALNST
2"		2015-B-ALNST
2-1/2"	2-1/2"	G250-B-ALNST
3"		3025-B-ALNST



#### Type D x Female NST (NH)

**Material**

- Nitrile rubber seals standard

Coupler Size	Female NST (NH) Thread	Aluminum Part #
1-1/2"	1-1/2"	G150-D-ALNST
2"	2-1/2"	2025-D-ALNST
2-1/2"		G250-D-ALNST
3"		3025-D-ALNST



#### Adapter x Male NST (NH)

Adapter Size	Male NST (NH) Thread	Aluminum Part #
1-1/2"	1-1/2"	G150-F-ALNST
2"	2-1/2"	2025-F-ALNST
2-1/2"		G250-F-ALNST
3"		3025-F-ALNST



## Brass Caps

### Pin Lug

**Feature**

- NOT intended for pressure applications - for debris and thread protection only 
- Finishes: -P polished, -C polished chrome plated



NST (NH) Thread	Cast Brass Part #
1-1/2"	FC150F
	FC150F-P
	FC150F-C
2"	FC200F
	FC250F
2-1/2"	FC250F-P
	FC250F-C
	FC300F
3"	FC400F
4"	FC450F
4-1/2"	FC600F
6"	

NPSH Thread	Cast Brass Part #
1-1/2"	FC150
2"	FC200
2-1/2"	FC250
3"	FC300
4"	FC400
6"	FC600

### Rocker Lug

**Feature**

- Finishes: -P polished, -C polished chrome plated



NST (NH) Thread	Cast Brass Part #
1"	RFC100F
1-1/2"	RFC150F
2-1/2"	RFC250F
	RFC250F-C

NPSH Thread	Cast Brass Part #
3/4"	RFC075
1"	RFC100
1-1/2"	RFC150
2"	RFC200
2-1/2"	RFC250

### Brass Test Caps

**Specification**

- Pet cock port supplied with 1/8" NPT
- Drain cock port supplied with -1/4" NPT



NST (NH) Thread	Brass Part #
2-1/2"	NST250TC

N

## Aluminum Caps with Cable Rocker Lug

**Features**

- Other configurations are available; consult Dixon® for information, not all configurations are stocked
- Aircraft cable (coated) included

Size	Thread	Extruded Hardcoated Aluminum Part #
1"	NST (NH)	CAP100F-C
1-1/2"		CAP150F-C
2"		CAP200F-C
2-1/2"		CAP250F-C
3"		CAP300F-C
4"		CAP400F-C
4-1/2"		CAP450F-C
5"		CAP500F-C
6"	CAP600F-C	
1"	NPSH	CAP100S-C
1-1/2"		CAP150S-C
2"		CAP200S-C
2-1/2"		CAP250S-C



### Long Handle

NST (NH) Thread	Extruded Hardcoated Aluminum Part #
4"	CAP400F-C-LH
4-1/2"	CAP450F-C-LH
5"	CAP500F-C-LH
6"	CAP600F-C-LH



## Aluminum Test Caps

**Specification**

- Supplied with 1/4" NPT drill and tap

Size	Thread	Aluminum Part #
1-1/2"	NST (NH)	CAP150FABS
2"		CAP200FABS
2-1/2"		CAP250FABS
3"		CAP300FABS
4"		CAP400FABS
4-1/2"		CAP450FABS
5"		CAP500FABS
6"		CAP600FABS
1-1/2"	NPSH	CAP150SABS
2"		CAP200SABS
2-1/2"		CAP250SABS
3"		CAP300SABS
4"		CAP400SABS
4-1/2"		CAP450SABS
5"		CAP500SABS
6"		CAP600SABS



### Thermoplastic Caps

#### Caps with Chain

**Application**

- Prevents entry of foreign material and protects male outlet threads on valves and hydrants

**Feature**

- NOT intended to be pressurized 



Size	Thread	Polycarbonate Part #
1-1/2"	NPSH	PFCW150
	NST (NH)	PFCW150F
2"	NPSH	PFCW200
2-1/2"	NST (NH)	PFCW250F
3"	NST	PFCW300F

#### Pressurizable Cap with Chains

**Specification**

- Can be pressurized to 300 PSI



Size	Thread	Polycarbonate Part #
2-1/2"	NST (NH) Thread	PFC250F

#### Hydrant Caps

**Size**

- 1-1/8" pentagonal nut with weep hole

**Feature**

- Gasket not included



NST (NH) Thread	Polycarbonate Part #
2-1/2"	PFCW250F-Y
4"	PFCW400F-Y
4-1/2"	PFCW450F-Y

#### Universal Hose Cap

**Application**

- Universal push on - pull off cap protects all threads by gripping the valve or outlet on the inside of the waterway

**Feature**

- NOT intended to be pressurized 



Size	Polycarbonate Part #
2-1/2"	PFC250U

N

## Breakable Caps

### Polycarbonate

**Application**

- Prevents entry of foreign material and protects female threads on pin lug fire department inlet connections

**Feature**

- Used on pin lug females

Size	Polycarbonate Part #
2-1/2"	PBC250



### Aluminum

**Applications**

- For use on fire department inlet connections
- Prevents entry of foreign matter and protects female threads

**Features**

- Breakable ears feature permits fast hose connection
- Two eyebolts with nuts for attachment to female pin lug swivel
- Painted red finish

Size	Aluminum Part #
2-1/2"	ABC250



## Specialty Caps

### Domestic Caps - Pin Lug

**Feature**

- Other sizes, threads, and finishes available, call Dixon® for information

Size	Thread	Brass Part #
1-1/2"	NST (NH)	FC150F-D
2-1/2"		FC250F-D



NOTE: Jack chains with S-hooks can be found on page 73

### Hydrant Caps

**Features**

- Pentagon fire hydrant cap
- Supplied with chain and ring

Size	Thread	Iron Part #
2-1/2"	NST (NH)	IHC250F
4-1/2"		IHC450F



NOTE: Jack chains with S-hooks can be found on page 73

## Specialty Caps

### Plugs with Cable - Rocker Lug

**Feature**

- -NC: no cable option available



Size	Extruded Hardcoated Aluminum	
	NST (NH) Part #	NPSH Part #
1-1/2"	PLUG150F-C	PLUG150S-C
2-1/2"	PLUG250F-C	PLUG250S-C
3"	PLUG300F-C	PLUG300S-C
4"	PLUG400F-C	---
4-1/2"	PLUG450F-C	---
5"	PLUG500F-C	---
6"	PLUG600F-C	---

### Cap Test Gauges

**Application**

- Used for testing hose or static pressure on hydrants or trucks



**Features**

- Rocker lug swivel
- Petcock to release pressure

**Specification**

- Supplied with a 0-300 PSI glycerine 3-1/2" diameter gauge

NST (NH) Thread	Hardcoated Aluminum Part #
1-1/2"	AFC150F-TGWP
2-1/2"	AFC250F-TGWP

### FDC Plugs

**Feature**

- Removed from FDC with adjustable hydrant wrench

**Specifications**

- Fits standard 2-1/2" NST (NH) female swivel
- Withstands wide range of temperatures from -4°F to 200°F (-20°C to 93°C)
- 1-1/8" pentagonal nut with weep hole to allow for drainage



Size	Thread	Polycarbonate Part #
1-1/2"	NST (NH)	PP150F
2-1/2"	NST (NH)	PP250F
	NYFD	PP250NYFD

### Adjust-A-Plug

**Features**

- Molded red polycarbonate protective plug for swivel connections up to 2-1/2"
- Two adjustable metal plates installed in the back of the plug can be mated with your local thread
- Plug can be easily removed with a fire department spanner wrench



front



back

Polycarbonate Part #
PAP250

N

### Brass Plugs

#### Pin Lug

**Feature**

- NOT intended for pressure applications - for debris and thread protection only
- Finishes: -P polished, -C polished chrome plated



NST (NH) Thread	Cast Brass Part #
1-1/2"	FP150F
	FP150F-P
	FP150F-C
2-1/2"	FP250F
	FP250F-P
	FP250F-C
3"	FP300F
4"	FP400F
4-1/2"	FP450F

NPSH Thread	Cast Brass Part #
1-1/2"	FP150
2-1/2"	FP250

#### Rocker Lug

**Feature**

- Finishes: -P polished, -C polished chrome plated

NST (NH) Thread	Cast Brass Part #
1-1/2"	RFP150F
2-1/2"	RFP250F

#### Domestic Plugs - Pin Lug

NST (NH) Thread	Brass Part #
1-1/2"	FP150F-D
2-1/2"	FP250F-D

### Brass Replacement Swivels and Accessories

**Features**

- Replacement brass swivels for Dixon® fire department connections
- Swivel comes with gasket, set screw, and ball bearings needed to install on FDC
- Other configurations are available, contact Dixon for information

Size	Female Thread	Brass Part #
2-1/2"	NPSH (2.84x8)	PSNP250S
	NST (NH) (3.07x7.5)	PSNP250NST
	NYC/BA (3.00x8)	PSNP250NYC
	NYFD (3.03x8)	PSNP250NYFD
3"	NST (NH)	PSNP300NST
	NYFD	PSNP300NYFD

NOTE: 2-1/2" requires 50 ball bearings, 3" requires 58 ball bearings

#### Replacement Parts

Description	Part #
2-1/2" gasket	SW250
3" gasket	SW300F
ball bearings	4600300001
set screw	4601100418



4600300001

### FSA-Storz x Rigid Female

**Application**

- For use wherever a non-valved, locking coupling is required

**Specification**

- Working pressure: 150 PSI at 70°F (21°C)

**Materials**

- Nitrile rubber gaskets
- Cast aluminum lock lever assembly on 4", 5", and 6"

**Approval**

- Anodized components per MIL-A-8625 Type III Class 1

#### Storz x NST (NH) Female

Storz Size	NST (NH) Female Thread	6061-T6 Forged Aluminum Part #
1-1/2"	1-1/2"	FSA1515F
2"	1-1/2"	FSA2015F
	2-1/2"	FSA2025F
2-1/2"	2-1/2"	FSA2525F
3"	2-1/2"	FSA3025F
	2-1/2"	FSA4025F
	3"	FSA4030F
	4"	FSA4040F
	4-1/2"	FSA4045F
4"	5"	FSA4050F
	6"	FSA4060F
	2-1/2"	FSA5025F
	3"	FSA5030F
	4"	FSA5040F
5"	4-1/2"	FSA5045F
	5"	FSA5050F
	6"	FSA5060F
	6"	FSA6060F



#### Storz x NPT Female

Storz Size	NPT Female Thread	6061-T6 Forged Aluminum Part #
1-1/2"	1"	FSA1510T
	1-1/2"	FSA1515T
2"	1-1/2"	FSA2015T
	2"	FSA2020T
2-1/2"	1-1/2"	FSA2515T
	2"	FSA2520T
	2-1/2"	FSA2525T
3"	3"	FSA2530T
	3"	FSA3030T
	3"	FSA4030T
4"	4"	FSA4040T
	6"	FSA4060T
	3"	FSA5030T
5"	4"	FSA5040T
	5"	FSA5050T
	6"	FSA5060T
6"	4"	FSA6040T
	6"	FSA6060T



#### Storz x NPSH Female

Storz Size	NPSH Female Thread	6061-T6 Forged Aluminum Part #
1-1/2"	1-1/2"	FSA1515S
2"	1-1/2"	FSA2015S
2-1/2"	2-1/2"	FSA2525S
4"	4"	FSA4040S



NOTE: All adapters are made to approved Dixon® specifications.

NOTE: Replacement washers can be found on page 827

N



## SFSA - Storz x Swivel Female Adapter - Rocker Lug / Long Handle

**Materials**

- Nitrile rubber gaskets
- Cast aluminum lock lever assembly on 4", 5", and 6"

**Specification**

- Working pressure: 150 PSI at 70°F (21°C)

**Approval**

- Anodized components per MIL-A-8625 Type III Class 1

### Storz x NST (NH) Female Swivel

Storz Size	NST (NH) Female Swivel Thread	6061-T6 Forged Aluminum Part #
2-1/2"	2-1/2"	SFSA2525F
3"	2-1/2"	SFSA3025F
4"	2-1/2"	SFSA4025F
	3"	SFSA4030F
	4"	SFSA4040F
	4-1/2"	SFSA4045F
	6"	SFSA4060F
5"	2-1/2"	SFSA5025F
	4"	SFSA5040F
	4-1/2"	SFSA5045F
6"	6"	SFSA5060F
	6"	SFSA6060F



### Storz x NPSH Female

Storz Size	NPSH Female Swivel Thread	6061-T6 Forged Aluminum Part #
2-1/2"	2-1/2"	SFSA2525S
3"	3"	SFSA3030S
4"	4"	SFSA4040S
5"	6"	SFSA5060S



### Storz x NST (NH) Female Swivel - Long Handle

Storz Size	NST (NH) Female Swivel Thread	6061-T6 Forged Aluminum Part #
4"	4-1/2"	SFSA4045F-LH
5"	4"	SFSA5040F-LH
5"	4-1/2"	SFSA5045F-LH
6"	6"	SFSA6060F-LH



NOTE: All adapters are made to approved Dixon® specifications.  
 NOTE: Replacement washers can be found on page 827

### MSA - Storz x Rigid Male

#### Storz x NST (NH) Male



Storz Size	NST (NH) Male Thread	6061-T6 Forged Alumium Part #
1-1/2"	1-1/2"	MSA1515F
2"	1-1/2"	MSA2015F
2-1/2"	2-1/2"	MSA2525F
3"	2-1/2"	MSA3025F
4"	2-1/2"	MSA4025F
	4"	MSA4040F
	4-1/2"	MSA4045F
5"	2-1/2"	MSA5025F
	5"	MSA5050F

#### Storz x NPT Male



Storz Size	NPT Male Thread	6061-T6 Forged Alumium Part #
1-1/2"	1-1/2"	MSA1515T
2"	1-1/2"	MSA2015T
2-1/2"	2"	MSA2520T
	2-1/2"	MSA2525T
	3"	MSA2530T
3"	3"	MSA3030T
4"	4-1/2"	MSA4025T
	4"	MSA4040T
5"	4"	MSA5040T
6"	6"	MSA6060T

#### Storz x NPSH Male

N



1-1/2" x 1-1/2"

Storz Size	NPSH Male Thread	6061-T6 Forged Alumium Part #
1-1/2"	1-1/2"	MSA1515S
2"		MSA2015S

New

### SLSA - Storz Live Swivel



#### Specification

- Working pressure: 200 PSI at 70°F (21°C)

Storz	FNPT	6061-T6 Forged Alumium Part #
4"	4"	SLSA4040T
5"		SLSA5040T

NOTE: Optional configurations from 2-1/2" to 6" on the non-storz side.

### SFSA30 - Storz x Female Swivel 30° Elbow - Rocker Lug

**Feature**

- Screens available for 4" and 5" heads, consult Dixon® for information

**Materials**

- Nitrile rubber gaskets
- Cast aluminum lock lever assembly on 4", 5", and 6"

**Specification**

- Working pressure: 150 PSI at 70°F (21°C)

**Approval**

- Anodized components per MIL-A-8625 Type III Class 1

Storz Size	NST (NH) Female Swivel Thread	6061-T6 Forged Aluminum Part #
4"	4"	SFSA30-4040F
	5"	SFSA30-4050F
	6"	SFSA30-4060F
5"	3"	SFSA30-5030F
	4"	SFSA30-5040F
	4-1/2"	SFSA30-5045F
	6"	SFSA30-5060F



NOTE: Replacement washers can be found on page 827

### SFSA30 - Storz x Female Swivel 30° Elbow - Long Handle

**Materials**

- Nitrile rubber gaskets
- Cast aluminum lock lever assembly on 4", 5", and 6"

**Specification**

- Working pressure: 150 PSI at 70°F (21°C)

**Approval**

- Anodized components per MIL-A-8625 Type III Class 1

Storz Size	NST (NH) Female Swivel Thread	6061-T6 Forged Aluminum Part #
4"	4-1/2"	SFSA30-4045F-LH
	5"	SFSA30-4050F-LH
	6"	SFSA30-4060F-LH



NOTE: Replacement washers can be found on page 827

### NCS-CSF - 150 lbs. Carbon Steel Flange x Storz

150# Flange	Storz	Carbon Steel Part #
4"	5"	NCS-CSF-STZ450
	6"	NCS-CSF-STZ460
5"	4"	NCS-CSF-STZ540
	5"	NCS-CSF-STZ550
	6"	NCS-CSF-STZ560
6"	4"	NCS-CSF-STZ640
	5"	NCS-CSF-STZ650
	6"	NCS-CSF-STZ660



NOTE: For flange dimensions, diagrams and additional information please reference dixonvalve.com.

### NCS-CSF - 150 lbs. Carbon Steel Flange x Storz with Cap

150# Flange	Storz	Carbon Steel Part #
5"	6"	NCS-CSF-STZ650C
6"		NCS-CSF-STZ660C



NOTE: For flange dimensions, diagrams and additional information please reference dixonvalve.com.

### SSA - Storz x Storz Adapter



**Materials**

- Nitrile rubber gaskets
- Cast aluminum lock lever assembly on 4", 5" and 6"

**Specification**

- Working pressure: 150 PSI at 70°F (21°C)

**Approval**

- Anodized components per MIL-A-8625 Type III Class 1

Storz Size	Storz Size	6061-T6 Forged Alumium Part #
1-1/2"	2"	SSA1520
	2-1/2"	SSA1525
2"	2-1/2"	SSA2025
	3"	SSA2030
	4"	SSA2540
4"	5"	SSA4050
	6"	SSA4060
5"		SSA5060

### SSA30 - Storz x Storz 30° Elbow Adapters



**Materials**

- Nitrile rubber gaskets
- Cast aluminum lock lever assembly on 4", 5" and 6"

**Specification**

- Working pressure: 150 PSI at 70°F (21°C)

**Approval**

- Anodized components per MIL-A-8625 Type III Class 1

Storz Size	Storz Size	6061-T6 Forged Alumium Part #
5"	5"	SSA30-550

### Dixon® Storz Hydrant Conversion Adapters

N



**Features**

- Secured to hydrant by three set screws positioned around the rim
- Hydrant side: metal face to seal to gasketed face on hose
- Reflective stripe around the rim for ease of night time location

**Specification**

- Designed to adapt 4-1/2" NH threads found on most hydrants to Storz connection

Size	Part #
5" Storz x 4-1/2" NH (NST)	SHA5045F

## Storz Accessories

### Threaded Storz Mounting Plates (Bracket)

Storz Size	Anodized Aluminum Part #
1-1/2" - 2-1/2"	SMB1525
4" - 5"	SMB450



### Storz Caps

#### Features

- 4", 5", 6" supplied with cables
- 1-1/2", 2", 2-1/2", 3" supplied with chains

Storz Size	Aluminum Part #
1-1/2"	SC150-NL
2"	SC200-NL
2-1/2"	SC250-NL
3"	SC300-NL
4"	SC400-NL
4" ABS	SC400ABS <sup>1</sup>
5"	SC500-NL
5" ABS	SC500ABS <sup>1</sup>
6"	SC600-NL



<sup>1</sup> ABS includes airbleeder/petcock

### Storz Gaskets

#### Features

- Gasket faces should be kept free of sand, grit, etc. and lubricated with O-ring grease or silicone
- Pressure seals have a flat face
- Suction seals have a beaded face



Storz Size	Nitrile Rubber Pressure Part #	Nitrile Rubber Suction Part #
1-1/2"	SGS150-NL <sup>1</sup>	SGS150-NL
2"	SGP200	SGS200-NL
2-1/2"	SGP250	SGS250-NL
3"	SGP300	SGS300-NL
4"	SGP400	SGS400-NL
5"	SGP500	SGS500-NL
6"	SGS600-NL <sup>1</sup>	SGS600-NL



<sup>1</sup> Gasket can be used for both pressure and suction service

### Storz Locking Devices

Description	Part #
metal locking device used on 4" and 5" Storz heads with spring, screw, and washer	LOCKINGDEVICE
metal locking device used on 6" Storz heads with spring, screw, and washer	LOCKINGDEVICE6



## Wrenches

### Universal Spanner



**Application**

- For 3/4" to 3" pin lug and rocker lug couplings

**Feature**

- Includes gas cock shutoff, pry bar and belt hook eye

**Size**

- Overall length 11-7/8"

<b>Aluminum Part #</b>	<b>Pkg Qty</b>
USW	25

### Universal



**Application**

- For pin lug or rocker lug couplings 1" - 4-1/2"

**Features**

- Red epoxy painted
- A gas cock shutoff is provided in the handle

**Size**

- Overall length 11-3/4"

<b>Iron Part #</b>
233

### Hole Type Spanner



**Application**

- Designed for use on 3/4" and 1" booster hose couplings

**Size**

- Overall length is 7-1/2"

<b>AL-MAG 35 Part #</b>
HTSW

### Storz Hydrant



**Features**

- Fits 4" and 5" Storz
- Includes adjustable hydrant nut wrench

**Materials**

- Ductile iron head
- Knurled chrome plated handle
- Manganese bronze adjustable jaw

<b>Part #</b>
SAHW

### Folding Pocket Spanners



PSW



PSW-B



PSW-Z



PSW-Y

**Application**

- For pentagon nuts up to 1-3/4"

**Feature**

- Built-in spanner for pin or rocker lug couplings

**Size**

- Overall length 16-1/4"

Material	Part #
aluminum	PSW
brass	PSW-B
die cast zinc	PSW-Z
yellow plastic	PSW-Y

### Adjustable Hydrant



**Features**

- Fits 3/4" to 3" rocker lug and pin lug couplings
- A compact wrench easily carried in your jacket pocket

<b>Aluminum Part #</b>	<b>Pkg Qty</b>
AHW	20

N

## Wrenches

### Pigtail Adjustable Hydrant

**Feature**

- Double spanner head fits pin lug or rocker (sensible) lug couplings, pentagon nuts up to 1-1/2" from point to flat, 1-1/2" - 6" rocker lug caps, 2" - 4-1/2" pin lug caps, and square nuts up to 1-1/8"



**Part #**

AHWPT

### Heavy Duty Adjustable Hydrant

**Application**

- For pentagon hydrant nuts up to 1-3/4" from point to flat

**Features**

- Notched to fit 1-1/4" square hydrant nut
- Spanner for pin lug and sensible (rocker) lug couplings, 1-1/2" thru 6"

**Size**

- Overall length 18"

**Materials**

- Plated iron head, 7/8" plated steel handle



**Part #**

189

**Pkg Qty**

15

### Double Head Adjustable Hydrant

**Application**

- For pentagon hydrant nuts up to 1-7/8" and square heads up to 1-1/2"

**Feature**

- Fits 3/4" - 6" rocker lug or pin lug couplings, can also be used for long handle couplings

**Size**

- Overall length 19-1/2"

**Materials**

- Ductile iron head with a deeply knurled chrome plated steel handle
- Replaceable adjustable jaw is made of manganese bronze



**Part #**

189DH

### 5 Hole Hydrant

**Size**

- Overall length: 14-1/4"

**Features**

- Five pentagon holes designed to fit common hydrant nut sizes
- Built-in spanner for pin or rocker lug couplings



**Plated Iron Part #**

PHW

**Pkg Qty**

25

### Grip-All Spanner

**Features**

- Fits 3/4" - 6" split lug, rocker lug, and pin lug couplings
- Can be operated in tight quarters
- Gas cock shutoff is provided in the handle; handle is shaped to fit your hand allowing a positive grip on the coupling



**Aluminum Part #**

GAW

## Wrenches

### Hydrant



**Application**

- Used for hydrant work by water works companies and on construction sites

**Size**

- 1-1/4" square hydrant wrench
- Overall length 15"

**Features**

- Fits up to 4" pin lug or rocker lug couplings
- Complete with pry bar

**A356 Aluminum**

**Part #**

DF16-180

**Features**

- Fits up to 2-1/2" pin lug or rocker lug couplings
- Complete with pry bar and 1-1/4" nut wrench
- Lug / drum wrench



**A356 Aluminum**

**Part #**

DF16-181

### Long Handle Suction Spanner

**Application**

- Use on long handle, rocker lug, or pin lug couplings from 2-1/2" - 6"

**Size**

- Overall length 18-3/4"

**Features**

- Open end slips over long handles for additional leverage, the claw fits rocker lugs or pin lugs, the other end can be used as a pry or crowbar
- Inverted "T" body construction for lighter weight and improved strength
- Can be used on Dixon® cam and groove pin lug or trapezoidal lug tank car adapters or 8" pin lug couplings



**Plated Iron**

**Part #**

LHW

### Forestry Hose Clamp and Spanner

**Size**

- Overall length 10"

**Material**

- Cast aluminum and brass

**Features**

- Off-set handle enables the user to easily operate the clamp while wearing gloves
- When clamped onto the hose the brass locking device safely holds the clamp in position, a spanner is an integral part of the clamp

**Specification**

- To be used with lightweight 1" and 1-1/2" hoses for pressures up to **200 PSI**



**Cast Aluminum**

**Part #**

FHCS150

### Forestry Pocket Spanners

**Applications**

- FSW1: for use on 1" hoses only
- FSW2: for 1" and 1-1/2" hose couplings

**Size**

- Overall length 5"

**Approval**

- Meets USFDA specification 5100-101C



**Aluminum**

**Part #**

FSW1

FSW2

N



## Storz Wrenches

### Pin Lug Spanners - Single End

Size	Plated Iron Part #
2"	SW20
2-1/2"	SW25
3"	SW30
4"	SW40
6"	SW60



### Pin Lug Spanner - Double End

Size	Plated Iron Part #
1-1/2", 2" x 2-1/2", 3"	SW153



### Spanner - Single End

**Features**

- SW1530 fits 1-1/2" - 3" Storz
- SZW2 for use on 4" and 6" Storz

Size	AL-MAG 35 Part #
1-1/2" - 3"	SW1530
4" - 6"	SZW2



SZW2



SW1530

### Spanners - Double End

Used On	Material	Part #
2" - 5"	aluminum	SZW2-NL
	steel	SW-S400



SZW2-NL



SW-S400



### Holder with (2) Wrenches - Double Ended

Description	Material	Part #
2 Storz wrenches (2-1/2" - 5") with bracket	aluminum	SWB-2
	steel	SWB-S-2
4 Storz wrenches (2-1/2" - 5") with bracket	steel	SWB-S-4



### Long Handle Short Shank Suction Hose Females



**Application**

- For suction and low pressure discharge only

**Material**

- Powder coated aluminum swivel nut

Female Swivel NST (NH)	Hose Size	Powder Coated Aluminum Part #
4"	4"	LHFS400F
4-1/2"		LHFS4045F

### Angle and Suction Elbows

**Application**

- For use on pump discharge valves, or suction inlets to minimize hose kinking

**Features**

- Rocker lug swivel
- Satin brass finish

**Material**

- -C polished chrome plated



30° elbow



45° elbow

Male NST (NH) Thread	Female NST (NH) Thread	Angle	Brass Part #
2-1/2"	2-1/2"	30°	RSE30250F-C
		45°	RSE45250F
			RSE45250F-C
		90°	RSE90250F
			RSE90250F-C

### Continuous Swivel Elbows

**Features**

- Allows hose to swing when connected
- Full waterway reduces friction loss
- Short style radius is 2-1/2" measured from the center of the waterway to the end of the discharge thread



Female NPT Thread	Male Thread	Length	Cast Brass Part #
1-1/2"	1-1/2" NST (NH)	2-1/2"	CSES150F
2"			CSES2015F
1-1/2"	1-1/2" NPT		CSES150T

### Dixon® Angle and Suction Elbows N54

**Application**

- Ideal for fire apparatus with front suction connections

**Materials**

- Anodized, powder coated aluminum, extruded
- Anodized female swivel connections



90° elbow

Male NST (NH) Thread	Female NST (NH) Swivel Thread	Angle	Aluminum Part #
2-1/2"	2-1/2"	30°	N5430-25F25F
		45°	N5445-25F25F
		60°	N5460-25F25F
		90°	N5490-25F25F

NOTE: Replacement washers can be found on page 814

N

### Pump Test Headers

**Feature**

- Other sizes and configurations available, consult Dixon® for information

**Specification**

- Available connections: grooved, flanged, and threaded

**Approval**

- Certified D1, G1, G6

End Connection	End Size	# of Outlets	Pump Size Max. GPM	Part #
150# flanged	3"	1	300	HVF0301-25
	4"	2	500	HVF0402-25
	6"	3	750	HVF0603-25
	6"	4	1000	HVF0604-25
	6"	6	1000	HVF0606-25
	8"	6	2000	HVF0806-25
grooved	6"	3	750	HVG0603-25
	6"	4	1000	HVG0604-25
	8"	3	750	HVG0803-25
	8"	6	2000	HVG0806-25



flanged

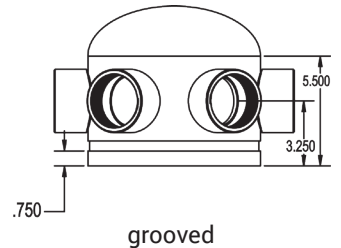

grooved

### Manifolds

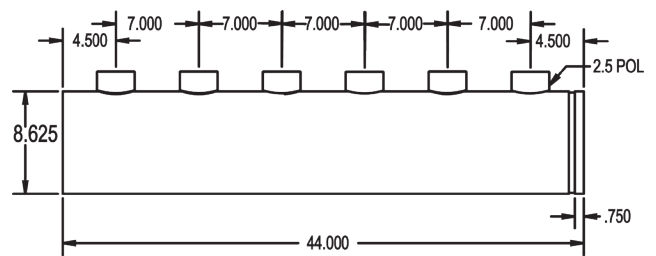
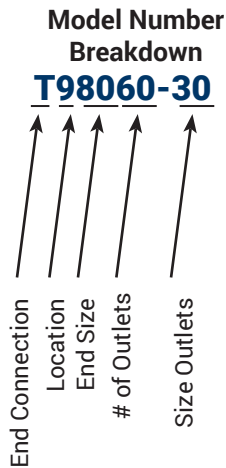

End Connection	Location	End Size	# of Outlets	Outlet Size	
T	threaded	E End	40 20	4" 2	25 2-1/2" FNPT
G	grooved	B Back	60 30	6" 3	30 3" FNPT
F	flanged	9 90°	80 40	8" 4	---
---	---	---	60 60	---	---

### Dry Hydrants

#### Typical Dry Hydrant Installations

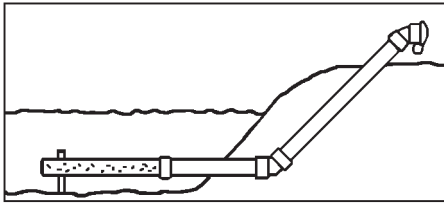

45°  
(preferred)

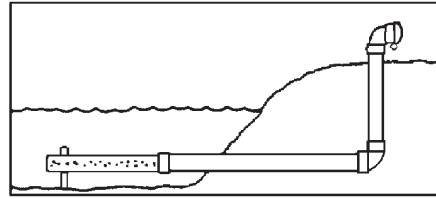

90°

### Underwater Strainer Supports



Description	Part #
underwater strainer support	DHSSC6

### Back Flushing Strainers

**Size**

- Length: 37"



Size	Schedule 40 PVC Part #
6"	DHS6BF
8"	DHS8BF <sup>1</sup>

<sup>1</sup>Includes 8" x 6" reducer

### Male Adapters and Caps

90° Male Adapters

45° Male Adapters



adapters and caps sold separately

Male NST (NH)	Hardcoated Part #	Hardcoated Part #
4-1/2"	ADH90M45F	ADH45M45F
6"	ADH90M60F	ADH45M60F

### Rocker Lug Caps with Cable

Female NST (NH)	Hardcoated Part #
4-1/2"	ADHC450F
6"	ADHC600F

### Female Adapters and Plugs

90° Female Adapters

45° Female Adapters



adapters and plugs sold separately

Female NST (NH)	Hardcoated Part #	Hardcoated Part #
4-1/2"	ADH90F45F	ADH45F45F
6"	ADH90F60F	ADH45F60F

### Rocker Lug Plugs with Cable

Male NST (NH)	Hardcoated Part #
4-1/2"	ADHP450F
6"	ADHP600F



## Two-Way Male Outlet - Roof Connections

### Application

- Used to create roof connections, fire pump test connections, wall hydrants or sidewalk (free standing) hydrants

### Feature

- Other configurations are available, contact Dixon® for additional information

### Specifications

- Maximum operating pressure: **175 PSI at 70°F (21°C)**
- Provides **250 GPM** minimum per outlet

### Approval

- UL listed

### Back Outlet

Pipe Size	(2) Outlets Male	Cast Brass Part #
4"	2-1/2" NPT	IRC4025
		FRC4025
	2-1/2" NST (NH)	IRC4025F
		FRC4025F
6"	2-1/2" NPT	FRC6025
	2-1/2" NST (NH)	FRC6025F

Groove Size	(2) Outlets Male	Cast Brass Part #
4"	2-1/2" NST (NH)	IRC4025GF

### Dimensions

Size	A	B	C
4" x 2-1/2" x 2-1/2"	7-7/8"	5-3/16"	5-1/4"
6" x 2-1/2" x 2-1/2"	8-3/16"	6-3/8"	7-5/8"

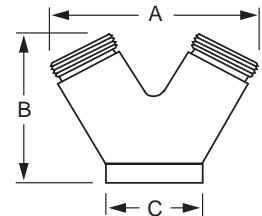



## Two-Way Male Outlet - Roof Connections

### Application

- Used to create roof connections, fire pump test connections, wall hydrants or sidewalk (free standing) hydrants

### Specifications

- Maximum operating pressure: **175 PSI at 70°F (21°C)**
- Provides **250 GPM** minimum per outlet

### Approval

- UL listed

### 90° Bottom Outlet



Pipe Size	(2) Outlets Male	Cast Brass Part #
4"	2-1/2" NPT	90IRC4025
		90FRC4025
	2-1/2" NST (NH)	90IRC4025F
		90FRC4025F
6"	2-1/2" NPT	90FRC6025
	2-1/2" NST (NH)	90FRC6025F

Groove Size	(2) Outlets Male	Cast Brass Part #
4"	2-1/2" NPT	90IRC4025G
	2-1/2" NST(NH)	90IRC4025GF

N

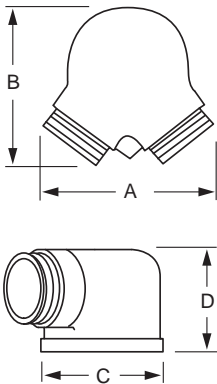

### Dimensions

Size	A	B	C	D
4" x 2-1/2" x 2-1/2"	7-1/2"	6-3/4"	5-1/8"	4-1/2"
6" x 2-1/2" x 2-1/2"	9"	8-1/2"	7-1/2"	5"

### Three-Way Male Outlet - Roof Connections

**Application**

- Used to create roof connections, or fire pump test connections

**Specification**

- Provides **250 GPM** minimum per outlet

**Back Outlet**

Pipe Size	(3) Outlets Male	Cast Brass Part #
4"	2-1/2" NPT	FR3C4025
6"	2-1/2" NPT	FR3C6025
	2-1/2" NST (NH)	FR3C6025F

**Dimensions**

Size	A	B	C
4" x 2-1/2" x 2-1/2" x 2-1/2"	12-3/4"	8-3/4"	5-1/4"
6" x 2-1/2" x 2-1/2" x 2-1/2"	15-3/8"	9-3/4"	7-5/8"

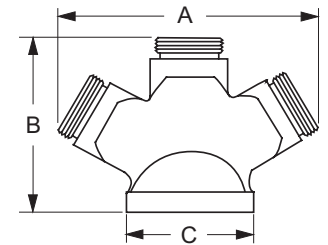

**Bottom Outlet**

Pipe Size	(3) Outlets Male	Cast Brass Part #
4"	2-1/2" NPT	90FR3C4025
	2-1/2" NST (NH)	90FR3C4025F
6"	2-1/2" NPT	90FR3C6025
	2-1/2" NST (NH)	90FR3C6025F

**Dimensions**

Size	A	B	C	D
4" x 2-1/2" x 2-1/2" x 2-1/2"	7-3/4"	11-3/4"	4-7/16"	6-1/4"
6" x 2-1/2" x 2-1/2" x 2-1/2"				

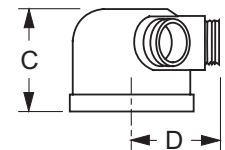
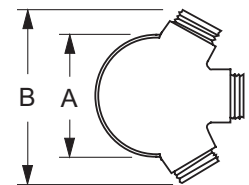

### Sleeve for Sidewalk (Free Standing) Connections

**Application**

- Used in conjunction with a sidewalk escutcheon and a 90° double clapper Siamese to create a sidewalk (free standing) fire department connection
- Finishes: -P polished, -C polished chrome plated

Pipe Size	Length	Brass Part #
4"	18"	SS418-P
		SS418-C
	24"	SS424-P
		SS424-C
6"	18"	SS618-P
		SS618-C
	24"	SS624-P
		SS624-C



### Single Clapper Siamese Connections

**Features**

- Single swing clapper with (2) pin lug swivel inlets
- Design provides unobstructed waterway
- Exposed Fire Department Connections (FDC) provide an economical method of satisfying local fire codes
- Branding: Auto-Spkr
- Replacement swivels can be ordered on page 821
- Finishes: -P polished or -C polished chrome plated

**Specifications**

- Maximum operating pressure: **250 PSI at 70°F (21°C)**
- Provides **500 GPM** minimum to supplement the fire protection as an auxiliary inlet connection to the water supply (**250 GPM** minimum per inlet)



**Back Outlet**

**Approval**

- UL listed and FM approved

Outlet Female NPT Thread	(2) Inlets Female Thread	Cast Brass Part #
4"	2-1/2" NST (NH)	SCS4025F
		ISCS4025F <sup>1</sup>

<sup>1</sup> Imported

**Dimensions**

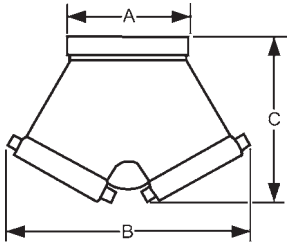

Size	A	B	C
4" x 2-1/2" x 2-1/2"	5-1/8"	9"	6-1/16"

NOTE: Dimensions match SCS4025F and SCS4025NYFD

N



**Bottom Outlet**

**Approval**

- UL listed

Outlet Female NPT Thread	(2) Inlets Female Thread	Cast Brass Part #
4"	2-1/2" NST (NH)	90SCS4025F
		90ISCS4025F <sup>1</sup>

<sup>1</sup> Imported

**Dimensions**

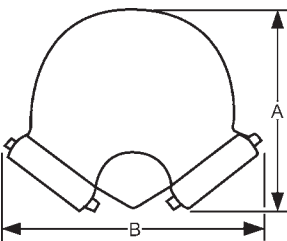

Size	A	B
4" x 2-1/2" x 2-1/2"	6-7/8"	9-7/8"

NOTE: Dimensions match 90SCS4025F and 90SCS4025NYFD





## Double Clapper Siamese Connections

### Features

- Double drop clapper with (2) pin lug swivel inlets provides required **500 GPM** minimum to supplement the fire protection as an auxiliary inlet connection to the water supply (**250 GPM** minimum per inlet)
- Exposed Fire Department Connections (FDC) provide an economical method of satisfying local fire codes
- Finish: -P polished or -C polished chrome plated

### Specification

- Maximum operating pressure: **175 PSI** at **70°F (21°C)**

### Approval

- UL listed and FM approved

### Back Outlet

Outlet Female NPT Thread	(2) Inlets Female Thread	Branding	Cast Brass Part #
4"	2-1/2" NST(NH)	AutoSprinkler	DCS4025F
			DCS4025F-P
			DCS4025F-C
		StandPipe	DCS4025F-SP
	No Branding	DCS4025F-NB	
6"	3" NST(NH)	AutoSprinkler	DCS4030F
			DCS4030NYFD
	3" NYFD	AutoSprinkler	DCS6025F <sup>1</sup>
			StandPipe



### Dimensions

Size	A	B
4" x 2-1/2" x 2-1/2"	9-5/8"	12-1/4"
6" x 2-1/2" x 2-1/2"	10-1/4"	11-3/4"
4" x 3" x 3"	10"	12-1/2"
6" x 3" x 3"	10-3/8"	12-1/2"

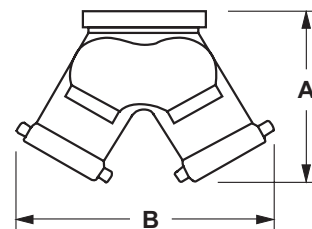

### Bottom Outlet

Outlet Female NPT Thread	(2) Inlets Female Thread	Branding	Cast Brass Part #	
4"	2-1/2" NST(NH)	AutoSprinkler	90DCS4025F	
			90DCS4025F-P	
			90DCS4025F-C	
	3" NST(NH)	AutoSprinkler	90DCS4025F-SP	
			No Branding	90DCS4025F-NB
			90DCS4030F	
3" NYFD	AutoSprinkler	90DCS4030NYFD		
		StandPipe	90DCS4030NYFDSP	
		90DCS4030NYFDSP		
6"	2-1/2" NST(NH)	AutoSprinkler	90DCS6025F <sup>1</sup>	
		StandPipe	90DCS6025F-SP <sup>1</sup>	
	3" NYFD	AutoSprinkler	90DCS6030NYFD <sup>2</sup>	



### Dimensions

Size	A	B	C
4" x 2-1/2" x 2-1/2"	11-3/4"	9-5/8"	7-1/4"
6" x 2-1/2" x 2-1/2"	11-3/4"	10-3/4"	
4" x 3" x 3"	12-1/2"	10-1/8"	
6" x 3" x 3"	12-1/4"	10-7/8"	

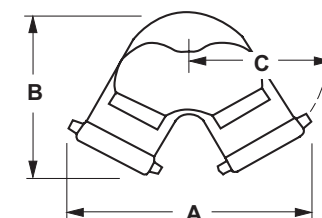

NOTE: Special threads, branding, and finishes are available, consult Dixon® for information

NOTE: Replacement swivels can be ordered on page 821

<sup>1</sup> Models are not UL listed or FM approved

<sup>2</sup> Models are UL listed but not FM approved

### Triple Clapper Siamese Connections

**Feature**

- Branding: see below

**Material**

- Finishes: -P polished or -C polished chrome plated

**Specification**

- Maximum operating pressure: 175 PSI at 70°F (21°C)



polished

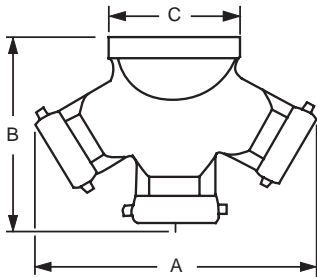

**Back Outlet**

Outlet Female NPT Thread	(3) Inlets Female NST (NH) Thread	Branding	Cast Brass Part #
4"	2-1/2"	AutoSprinkler	TCS4025F
		StandPipe	TCS4025F-SP
		No Branding	TCS4025F-NB
6"		AutoSprinkler	TCS6025F
		StandPipe	TCS6025F-SP
		No Branding	TCS6025F-NB

**Dimensions**

Size	A	B	C
4" x 2-1/2" x 2-1/2" x 2-1/2"	13-3/4"	10-1/2"	5"
6" x 2-1/2" x 2-1/2" x 2-1/2"			7-1/2"

**Bottom Outlet**



N

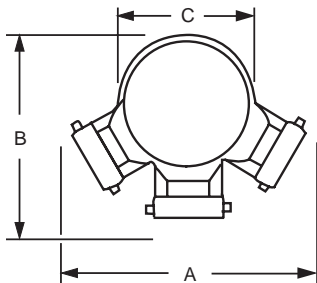

Outlet Female NPT Thread	(3) Inlets Female NST (NH) Thread	Branding	Cast Brass Part #
4"	2-1/2"	AutoSprinkler	90TCS4025F
		No Branding	90TCS4025F-NB
6"		AutoSprinkler	90TCS6025F
		No Branding	90TCS6025F-NB

**Dimensions**

Size	A	B	C
4" x 2-1/2" x 2-1/2" x 2-1/2"	14-1/2"	11-1/2"	7-5/8"
6" x 2-1/2" x 2-1/2" x 2-1/2"			

NOTE: Special threads, branding, and finishes are available; consult Dixon® for information  
 NOTE: Replacement swivels can be ordered on page 821

## Reversible Concealed Angle Siamese Body



### Application

- Stainless steel FDC provides water up to 90 stories without auxiliary pumping systems

### Sizes

- Bodies: 4" and 6"
- Snoots: 2-1/2" x 2-1/2" and 2-1/2" x 3"

### Features

- Uniquely designed clappers are fully reversible with perpendicular trunnion, allowing one body to be installed for top or bottom connections
- Concealed unit mounts behind a wall plate; escutcheon sold separately for exposed installation

### Materials

- Body: 316 stainless steel
- Shutters: 4" x 2-1/2": brass  
6" x 3": 316 stainless steel
- Snoots: 316 stainless steel
- Pivot pins: brass on concealed units, stainless steel on exposed units

### Specifications

- 4" x 2-1/2" maximum working pressure: **500 PSI**
- 6" x 3" maximum working pressure: **600 PSI**

### Approvals

- 4" x 2-1/2" is FM Approved
- 6" x 3" is FM and New York Fire Department approved



4" X 2-1/2"  
(unpolished finish)



6" X 3"  
(unpolished finish)



6" X 3"  
(polished finish)

Inlet	(2) Outlets	Description	Stainless Steel Part #
4" NPT	2-1/2" NPT	concealed angle body	4025REV90SS
6" grooved	3" NPT	concealed straight body	DCS6030GSS
6" NPT	3" NPT	concealed or exposed angle body	90CREV6030SS
		concealed or exposed angle body polished	90CREV6030SS-P
		reversible fire department connection assembly for concealed or exposed installation with proper identification plate	90CREV6030SSPAT

## Open Snoots

Swivel	NPT Thread	Stainless Steel Female Part #	Stainless Steel Male Part #
2-1/2" NST (NH)	2-1/2"	SF250FSS	SM250FSS
	3"	SF2530FSS	SM2530FSS
3" NST (NH)	3"	SF300FSS	SM300FSS
3" NYFD	3"	SF300NYFDSS	SM300NYFDSS



2-1/2" x 3" male  
(polished satin finish)



3" x 3" male  
(polished satin finish)

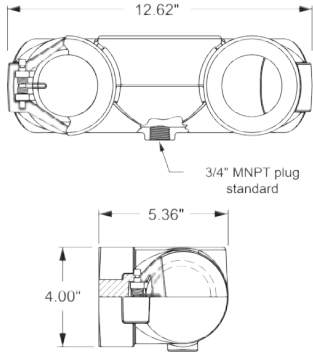

### Reversible Concealed Angle Siamese Bodies

**Features**

- Fully reversible with a perpendicular trunnion allowing one body to be installed for top and bottom connections
- Bodies require wall plate WP2 see page 845

**Specification**

- Maximum operating pressure: **250 PSI at 70°F (21°C)**

**Approvals**

- UL listed
- Approved by New York City Board of Standards and Appeals

Outlet Female NPT Thread	(2) Inlets Female NPT Thread	Brass Part #
4"	2-1/2"	4025REV90
	3"	4030REV90

### Reversible Concealed Angle Siamese Bodies

**Features**

- Fully reversible with a perpendicular trunnion allowing one body to be installed for top and bottom connections
- Replaces 23-391 bodies

**Specification**

- Maximum operating pressure: **250 PSI at 70°F (21°C)**



Outlet Female NPT Thread	(2) Inlets Female NPT Thread	Brass Part #
5"	2-1/2"	90CREV5025
	3"	90CREV5030
6"	2-1/2"	90CREV6025
	3"	90CREV6030

**Dimensions**

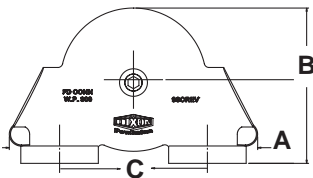

Size	A	B	C
5" x 3" x 3"	12"	9-1/2"	7-5/8"
6" x 2-1/2" x 2-1/2"	12"	7-1/4"	7-5/8"
6" x 3" x 3"	12"	9-1/2"	7-5/8"

N



## Concealed 2-Way Wall Hydrant Bodies

### Size

- 7-5/8" center-line

### Features

- Drop clappers provide unobstructed waterway
- Flush design is desirable when appearance is a factor
- Double clapper
- Bodies require wall plate WP2 (24-385), see page 845

### Specification

- Provides **500 GPM** minimums at **250 GPM** per inlet (ref. NFPA 14)

### Approval

- UL listed

### Back outlet

Outlet Female NPT Thread	(2) Inlets Female NPT Thread	Brass Part #
4"	2-1/2"	CDMHCB40225
	3"	CDMHCB40230
5"	3"	CDMHCB50230
6"	2-1/2"	CDMHCB60225
	3"	CDMHCB60230



### Dimensions

Size	A	B	C
4" x 2-1/2" x 2-1/2"	11-1/8"	6"	7-5/8"
4" x 3" x 3"	12-1/4"	8-1/8"	7-5/8"
5" x 3" x 3"	11-13/16"	7-5/16"	7-5/8"
6" x 2-1/2" x 2-1/2"	11-1/8"	7-3/8"	7-5/8"
6" x 3" x 3"	12-1/4"	8-1/4"	7-5/8"

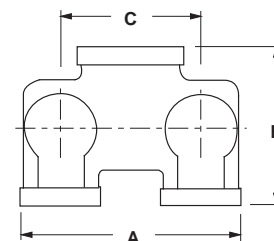

### Bottom outlet

Outlet Female NPT Thread	(2) Inlets Female NPT Thread	Brass Part #
5"	3"	90CDMHCB50230
6"	2-1/2"	90CDMHCB60225
	3"	90CDMHCB60230



### Dimensions

Size	A	B	C
5" x 3" x 3"	12"	9-1/2"	7-5/8"
6" x 2-1/2" x 2-1/2"	12"	7-1/4"	7-5/8"
6" x 3" x 3"	12"	9-1/2"	7-5/8"

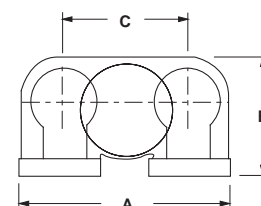

### Spring Check Type Snoots - Pin Lug

**Feature**

- Other configurations are also available, consult Dixon® for information
- Finishes: -P polished, -C polished chrome plated

**Specification**

- Maximum operating pressure: 175 PSI at 70°F (21°C)

**Female Outlet**

**Feature**

- Connections are attached to the bodies with pipe nipples (not included)

**Specification**

- Female NPT rigid with hexagon by female hose thread to swivel



polished chrome plated

Outlet Female NPT Thread	Inlet Female NST (NH) Thread	Cast Brass Part #
3"	2-1/2"	CSSTF25F30T-P
		CSSTF25F30T-C
	3"	CSSTF30F30T-P

**Dimensions**

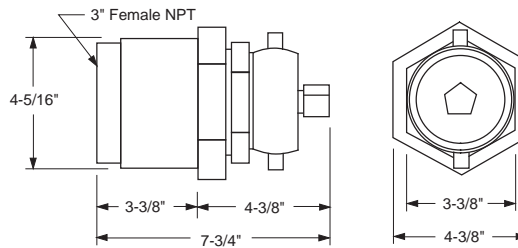

**Male Outlet**

**Feature**

- Used when a direct connection to bodies is desired
- Finishes: -P polished, -C polished chrome plated

**Specification**

- Male NPT x 2-1/2" female hose thread to swivel

N



polished

Outlet Male NPT Thread	Inlet Female NST (NH) Thread	Cast Brass Part #
3"	2-1/2"	CSSTM25F30T-P
		CSSTM25F30T-C
	3"	CSSTM30F30T-P
		CSSTM30F30T-C

**Dimensions**

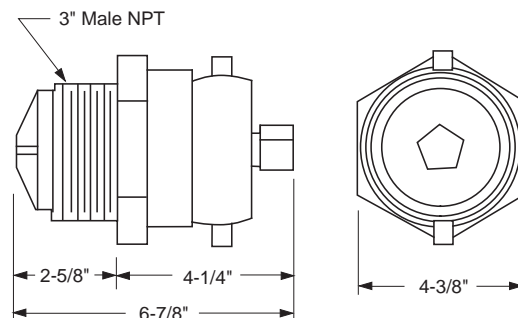

NOTE: Under no circumstances should a check snoot be installed directly into a pipe, as this may prevent the snoot from opening. Install directly into the appropriate standpipe body only.





### Clapper Type Snoots - Pin Lug

**Feature**

- Other sizes and threads are available, consult Dixon® for information
- Finishes: -P polished, -C polished chrome plated

**Approval**

- UL listed

Outlet Female NPT Thread	Inlet Female NST (NH) Thread	Cast Brass Part #
3"	2-1/2"	CSCTF25F30T-P
		CSCTF25F30T-C

Outlet Male NPT	Inlet Female NST (NH)	Cast Brass Part #
3"	2-1/2"	CSCTM25F30T-P
		CSCTM25F30T-C



polished chrome plated



polished

### Wall Plate for Double Clapper Siamese Assemblies

**Feature**

- 4-hole and 6-hole wall plates available, consult Dixon for information
- Finishes: -P polished, -C polished chrome plated

Hole Size	Branding	Brass Part #
3-3/8"	AutoSprinkler	WP2HAS-P
		WP2HAS-C
	StandPipe	WP2HSP-P
		WP2HSP-C
	AutoSprinkler StandPipe Combo	WP2H-ASSP-P
		WP2H-ASSP-C
	Hydrant	WP2H-HY-P
	PumpTest	WP2H-PT-P
		WP2H-PT-C



**Dimensions**

Hole Size	A	B	C	D
3-3/8"	14"	8"	7-5/8"	4-15/16"

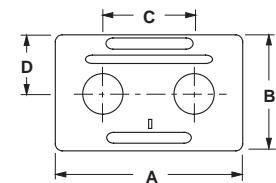

### Wall Plate for Concealed 3-Way Bodies

**Feature**

- 4-hole and 6-hole wall plates available, consult Dixon for information
- Finishes: -P polished, -C polished chrome plated

Hole Size	Positioned	Branding	Brass Part #
3-5/8"	Horizontal	AutoSprinkler	WP3HAS-P
			WP3HAS-C
		StandPipe	WP3HSP-P
			WP3HSP-C



**Dimensions**

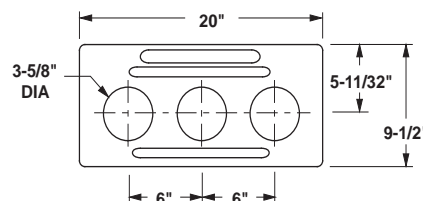



### Double Clapper Concealed Type Siamese Assemblies



**Features**

- Fully reversible with a perpendicular trunnion allowing one body to be installed for top and bottom connections
- Branded: 'standpipe', 'auto-sprkr', 'auto-sprkr-standpipe'
- Complete unit consisting of the following six parts: (1) 4025REV90, or 4030REV90, or 90CREV6025, (1) 24-385 plate, (2) 23-270 double female connections, (2) 17-127 plugs with chains
- Finishes: -P polished or -C polished chrome plated

**Specification**

- Maximum operating pressure: 250 PSI

**Approvals**

- UL listed, FM approved

Outlet Female NPT Thread	(2) Inlets Female NST (NH) Thread	Branding	Cast Brass Part #
4"	2-1/2"	AutoSprinkler	2WCA4025F-P
		StandPipe	2WCA4025F-SP-P
		AutoSprinkler	2WCA4025F-C
		StandPipe	2WCA4025F-SP-C
6"	2-1/2"	AutoSprinkler	2WCA4030F-P
		AutoSprinkler	2WCA6025F-P
		StandPipe	2WCA6025F-SP-P
		AutoSprinkler	2WCA6025F-C
6"	2-1/2"	AutoSprinkler	2WCA6025F-P
		StandPipe	2WCA6025F-SP-P
		AutoSprinkler	2WCA6025F-C
		StandPipe	2WCA6025F-SP-C

NOTE: Other branding and finishes are also available, consult Dixon® for information

### 2-Way Sidewalk Siamese Assemblies



**Feature**

- Complete unit consists of: (1) 21-133 90° Siamese body, double clapper, (2) 17-127 pin lug plugs with chains, (1) 23-404 sleeve, (1) 24-405 escutcheon plate
- Finishes: -P polished or -C polished chrome plated

**Approvals**

- UL listed, FM approved

Outlet Female NPT Thread	(2) Inlets Female Thread	Cast Brass Part #
4"	2-1/2"	2WSA4025F
		2WSA4025F-SP
6"		2WSA6025F
		2WSA6025F-SP

**Dimensions**

Size	A	B	C	E	F
4" x 2-1/2" x 2-1/2"	9-1/4"	10-3/8"	10-3/4"	10-3/8"	6-5/8"
6" x 2-1/2" x 2-1/2"	11-1/4"	10-1/2"	11-3/4"	13"	7-1/4"

NOTE: Some components UL listed/FM approved, not entire assembly

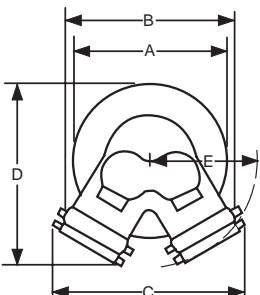

N



### Single Inlet Residential Sprinkler Connection

**Application**

- Complete single inlet connection (exposed type) used on residential automatic sprinkler systems

**Feature**

- Complete unit consists of: (1) 17-127 1-1/2" pin lug plug with chain and (1) 24-209 4-7/16" O.D. round escutcheon plate with swivel

Inlet Female NST (NH) Thread	Outlet Female NPT Thread	Cast Brass Part #
1-1/2"	1-1/2"	RIC150F



### Single Inlet Connections

**Features**

- Provides a complete exposed single inlet connection
- Complete unit consists of: (1) 24-209 round plate branded Auto Sprinkler, (1) 23-270 double female or 09-215 male and female connection, (1) 17-127 pin lug plug with chain
- Swivel end
- Finish: -P polished or -C polished chrome plated

**Specification**

- Rigid hexagon end of either connection is 2-1/2" NPT

Inlet Female NST (NH) Thread	Outlet Female NPT Thread	Brass Part #
2-1/2"	2-1/2"	SIC250F
		SIC250F-P
		SIC250F-C



### Single Hydrant Connection

**Feature**

- Complete unit consists of: (1) 24-209 round plate branded 'Wall Hydrant', (1) 23-272: 2-1/2" female and male connection, (1) 17-126 cap with chain
- Finish: -P polished or -C polished chrome plated

Inlet Female NPT Thread	Outlet Male NST (NH) Thread	Cast Brass Part #
2-1/2"	2-1/2"	MOCA250F



### Exposed 2-Way Wall Hydrants

**Features**

- DMOCA40225F consists of: (1) REP400HY round plate branded 'Wall Hydrant', (1) FRC4025F: 2-1/2" female and male connection, (2) FC250F cap with chain
- DMOCA60225F consists of: (1) REP600HY round plate branded 'Wall Hydrant' (1) FRC6025F: 2-1/2" female and male connection, (2) FC250F cap with chain
- Finish: -P polished or -C polished chrome plated

Inlet Female NPT Thread	(2) Outlets Male NST (NH) Thread	Cast Brass Part #
4"	2-1/2"	DMOCA40225F
6"		DMOCA60225F



### Round Identification Plates



REP250AS-C



REP250AS-P



REP400AS



**Application**

- Used to trim out and identify exposed fire department connections

**Size**

- For Siamese, made in 9-1/4" diameter for 4" pipe and 11-1/4" diameter for 6" pipe

**Feature**

- Finishes: -P polished, -C polished chrome plated

Pipe Size	Branding	Cast Brass Part #
2-1/2"	Auto-Sprinkler	REP250AS
		REP250AS-P
		REP250AS-C
	Wall Hydrant	REP250HY
	Pump Test	REP250PT
	Standpipe	REP250SP
REP250SP-P		
REP250SP-C		
4"	Auto-Sprinkler	AREP400AS <sup>1</sup>
		REP400AS
		REP400AS-P
		REP400AS-C
	Wall Hydrant	REP400HY
	Standpipe	REP400SP
		REP400SP-P
		REP400SP-C
Auto-Sprinkler & Standpipe	REP400AS/SP	
6"	Auto-Sprinkler	REP600AS
		REP600AS-P
		REP600AS-C
	Standpipe	REP600SP
		REP600SP-P
		REP600SP-C

<sup>1</sup> Aluminum

**Dimensions**

Size	O.D.	Hole Size
2-1/2"	7-5/8"	3-1/4"
4"	9-1/4"	4-5/8"
6"	11-1/4"	6-3/4"

## British Instantaneous Fittings

**Feature**

- Polished finish

**Approval**

- Meets BS336 specifications

### Female x Female Threads

Female BRIT Thread	Female Thread	Brass Part #
2-1/2"	2-1/2" NST (NH)	BID250F
	2-1/2" NPT	BID250T



### Female x Male Threads

Female BRIT Thread	Male Thread	Brass Part #
2-1/2"	2-1/2" NST (NH)	BIB250F
	2-1/2" NPT	BIB250T



### Male x Female Threads

Male BRIT Thread	Female Thread	Brass Part #
2-1/2"	2-1/2" NST (NH)	BIA250F
	2-1/2" NPT	BIA250T



### Male x Male Threads

Male BRIT Thread	Male Thread	Brass Part #
2-1/2"	2-1/2" NST (NH)	BIF250F
	2-1/2" NPT	BIF250T



### British Instantaneous Fittings



BIE150



BIC150



#### Hose Shanks

Size	Brass Part #
2-1/2" male BRIT x 1-1/2" hose shank	BIE150
2-1/2" male BRIT x 2-1/2" hose shank	BIE250
2-1/2" female BRIT x 1-1/2" hose shank	BIC150
2-1/2" female BRIT x 2-1/2" hose shank	BIC250

#### Plug

Size	Brass Part #
2-1/2"	BIDP250

#### Cap

Size	Brass Part #
2-1/2"	BIDC250

### International Shore Connections

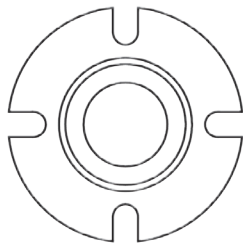

ship connection  
09-319

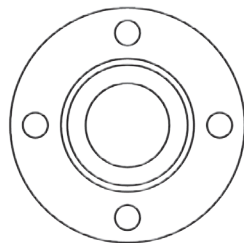

shore connection  
09-318

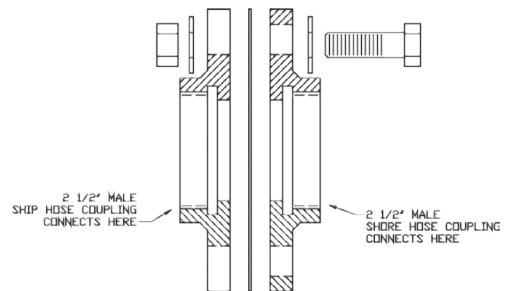

N

#### Size

- 7" O.D. brass flange with 4-3/4" holes

#### Applications

- Makes possible the connection of two different threads between ship and shore or between ships

#### Feature

- Includes 8 washers, 4 hexagon brass nuts, 4 hex head bolts, 1 washer, 1 fiber gasket

#### Specifications

- Working pressure: **300 PSI**
- NST (NH) threads standard, also available in NPT and NYFD threads

#### Approval

- Meets U.S. Coast Guard specifications for vessels 1000 gross tons or more



shore side



ship side

Description	Brass Part #
shore side	09-318-00001
ship side	09-319-00001

### Pick Head Fire Axes

**Size**

- 36" hickory handle

**Feature**

- Red trim

**Approval**

- Listed in the minimum requirements approval guides for outfitting hose houses and hose cabinets by insurance underwriters



Description	Part #
6 lb. axe	PHFA6
axe brackets	PHFA-B-A

### Sprinkler Line Tester

**Application**

- Installs on the last sprinkler head on system branch lines and controls water flow for flushing or testing the system

Inlet	Outlet	Brass Part #
1" female NPT	1" male NPSH	SLT10050





### Domestic Cast Angle Valves

**Material**

- Aluminum hand wheel

**Specification**

- Working pressure: 300 PSI at 70°F (21°C)

**Approval**

- UL listed and FM approved



**Female x Male**

Inlet Female NPT	Outlet Male Thread	Cast Brass Part #
1-1/2"	1-1/2" NST (NH)	AV150
	1-1/2" NPSH	AV150S
	1-1/2" NPT	AV150T
2-1/2"	2-1/2" NST (NH)	AV250
	2-1/2" NYFD	AV250NYFD <sup>1</sup>

<sup>1</sup> Supplied with red hand wheel



**Female x Female**

Inlet Female NPT	Outlet Female NPT	Cast Brass Part #
1-1/2"	1-1/2"	AVF150
2-1/2"	2-1/2"	AVF250

**Replacement Parts**

Description	Part #
aluminum handwheel for 1-1/2" valve	AV150-W
aluminum handwheel for 2-1/2" valve	AV250-W
handwheel nut for 1-1/2" valve	AV150-N
handwheel nut for 2-1/2" valve	AV250-N
valve seal rubber for 1-1/2" valve	AV150-RBR
valve seal rubber for 2-1/2" valve	AV250-RBR

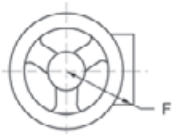

**Dimensions**

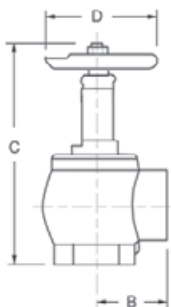

Size	A	B	C closed	C open	D	F
1-1/2"	2-11/64"	2-7/32"	6-5/8"	7-21/32"	3-3/4"	2-13/16"
2-1/2"	3-3/16"	3-3/16"	9-1/4"	11"	5"	3-19/32"

N

## Grooved Angle Valves



### Application

- Commercial fire protection

### Features

- Easy for contractor to install
- Groove inlet
- Made in the USA

### Material

- Nitrile rubber gasket

### Specification

- Working pressure: **300 PSI at 70°F (21°C)**

### Approvals

- UL listed, FM approved, ULC approved



Description	Cast Brass Part #
groove x male	AVG250F
groove x groove	AVG250G
groove x female	AVGF250

## 500# Angle Hose Valves



### Applications

- Fire department, gravity and pressure tank connections, test connections, and public water supplies to sprinkler and standpipe systems where it is necessary to access the system for a fire hose connection

### Feature

- Red handwheel

### Specifications

- Designed and approved to manage **500 PSI** pressures in piping systems
- Maximum operating pressure: **500 PSI at 70°F (21°C)**

### Approvals

- FM approved
- New York City Board of Standards and Appeals, approval # MEA 54-07-E

#### Female x Male

Inlet Female NPT	Outlet Male Thread	Cast Brass Part #
2-1/2"	2-1/2" NST (NH)	AV5-250F
	2-1/2" NYFD	AV5-250NYFD

#### Female x Female

Inlet Female NPT	Outlet Female NPT	Cast Brass Part #
2-1/2"	2-1/2"	AVF5-250





## Global Cast Angle Valves

### Features

- Available finishes:
  - cast (standard)
  - polished: -P
  - chrome: -C
- minimum quantity for special thread, consult Dixon®

### Material

- Aluminum handwheel

### Specifications

- NPT inlet thread only
- Working pressure: **300 PSI at 70°F (21°C)**

### Approvals

- UL listed and FM approved
- New York City Board of Standards and Appeals, approval # MEA 54-07-E



### Female Inlet

Inlet Female NPT	Outlet Male Thread	Cast Yellow DZR Brass Part #
1-1/2"	1-1/2" male NST (NH)	AV150-I
2-1/2"	2-1/2" male NST (NH)	AV250-I
	2-1/2" MNYFD	AV250NYFD-I

### Double Female

### Features

- Available finish:
  - cast (standard)
  - polished = -P
  - chrome = -C

### Material

- Aluminum handwheel

### Specifications

- NPT inlet and outlet
- Working pressure: **300 PSI at 70°F (21°C)**

### Approval

- New York City Board of Standards and Appeals, approval # MEA 54-07-E



Inlet Female NPT	Outlet Female NPT	Cast Yellow DZR Brass Part #
1-1/2"	1-1/2"	AVF150-I
2-1/2"	2-1/2"	AVF250-I

### Dimensions

Size	A	B	C closed	C open	D	E	Wt. in Lbs.
1-1/2"	4.13"	3.75"	6.80"	7.78"	2.25"	1.81"	4.4
2-1/2"	5.69"	5.00"	9.00"	10.72"	3.19"	2.59"	9.5

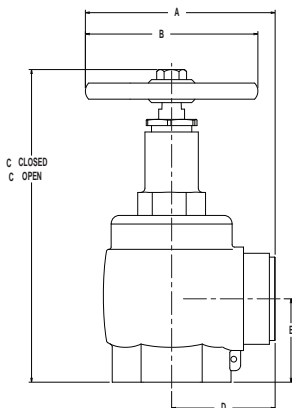

N





## Global Forged Angle Hose Valves

### Application

- To be used with a fire hose rack assembly; or as a fire department outlet connection

### Features

- Red steel handwheel
- Polished or chrome plated parts with other outlet threads are also available, consult Dixon® for information

### Specification

- Maximum operating pressure: **300 PSI at 70°F (21°C)**

### Approvals

- UL listed and FM approved

### Female x Male

Inlet Female NPT	Outlet Male Thread	Forged Brass Part #
1-1/2"	1-1/2" NST (NH)	AV151
2-1/2"	2-1/2" NST (NH)	AV251
	2-1/2" NYC	AV251NYC
	2-1/2" NYFD	AV251NYFD



### Female x Female

Inlet Female NPT	Outlet Female NPT	Forged Brass Part #
1-1/2"	1-1/2"	AVF151
2-1/2"	2-1/2"	AVF251



### Replacement Parts

Description	Part #
handwheel for 1-1/2" valve	AV151-WR
handwheel for 2-1/2" valve	AV251-WR
handwheel nut for 1-1/2" and 2-1/2" valve	AV251-N
valve seal rubber for 1-1/2" valve	AV151-RBR
valve seal rubber for 2-1/2" valve	AV251-RBR



handwheel nut



valve seal

N

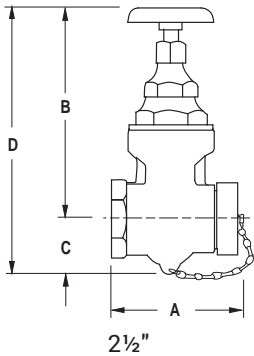

### Non-Rising Stem Wedge Disc Gate Valves

**Features**

- Cap not included on the NYFD threaded valve and special threaded valves
- Solid wedge disc with tapered seats
- Other configurations are available, contact Dixon® for additional information

**Materials**

- Red iron handwheel, with brass cap and chain

**Specification**

- Working pressure: 300 PSI at 70°F (21°C)

**Approvals**

- 2-1/2" UL listed, FM approved, ULC approved

Inlet Female NPT	Outlet Male Thread	UL Listed	Cast Brass Part #
1-1/2"	1-1/2" NST (NH)	no	WDGV150F
2-1/2"	2-1/2" NST (NH)	yes	WDGV250F
	2-1/2" NYFD		WDGV250NYFD

**Dimensions**

Size	A	B	C	D
1-1/2"	3-49/64"	5-5/8"	1-1/8"	6-3/8"
2-1/2"	6"	10-3/4"	2-1/2"	13-1/4"



N

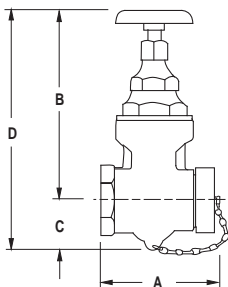

### Global Non-Rising Stem Wedge Disc Gate Valves

**Features**

- Available finishes:
  - cast (standard)
  - polished trim - P
  - cast chrome - RC
  - polished chrome trim - C
- Custom male thread available
- Non-rising stem

**Materials**

- Cast brass with solid wedge disc and tapered seats
- Red iron wheel handle with cap and chain (cap not supplied on non-standard threads)
- Alloy = DZR brass
- Furnished with 2-1/2" NST brass cap and chain

**Specification**

- Working pressure: 300 PSI (2069 kPa)

**Approvals**

- UL listed and FM approved

Inlet Female NPT	Outlet Male NST	UL Listed	Cast DZR Brass Part #
2-1/2"	2-1/2"	yes	GWDGV250F

**Dimensions**

Size	A	B	C	D
2-1/2"	5"	7-3/4"	2-1/2"	10"

## Non-Rising Stem Wedge Disc Gate Valves



### Application

- For use on standpipes, fire pumps, and hydrants

### Features

- Satin finish
- Red handwheel
- Solid wedge disc with tapered seats
- Straightway pattern

### Specification

- Working pressure: 300 PSI at 70°F (21°C)

### Approvals

- UL listed and FM approved



Inlet Female NPT	Outlet Male NST (NH)	Forged Brass Part #
2-1/2"	2-1/2"	WDGV251F
3"		WDGV3025F

## Rising Stem Wedge Disc Gate Valves

### Features

- Solid wedge disc with tapered seats
- Not recommended for wet standpipe systems, use AV250 (18-157) for this purpose, see page 852
- Other configurations are available, contact Dixon® for additional information



### Materials

- Red iron handwheel, with brass cap and chain

Inlet Female NPT	Outlet Male	Working Pressure PSI	UL Listed	Cast Brass Part #
2-1/2"	2-1/2" NST (NH)	200	no	RWDGV250F
3"		300	yes	RWDGV3025F



### Dimensions

Size	A	B closed	C	D closed	D open
2-1/2"	6-1/2"	11	2-1/2"	13-1/2"	16-1/4"
3" x 2-1/2"	6-3/16"				

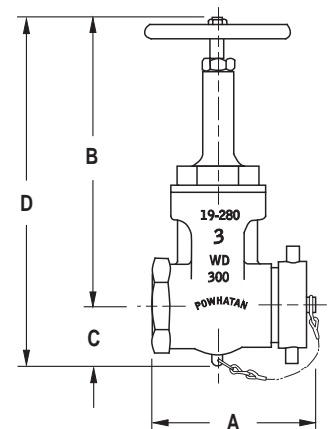



### Single Hydrant Gate Valves with Hand Wheel

**Applications**

- Used to throttle the flow from a fire hydrant preventing damage to the hydrant
- For use on standpipes and fire pumps where UL listing is required

**Features**

- O-ring seal
- Other configurations are available, contact Dixon® for additional information

**Specification**

- Maximum operating pressure: **175 PSI** (water only) at **70°F (21°C)**

**Approval**

- UL listed



Inlet Female	Outlet Male	Cast Red Brass Part #
2-1/2" NST (NH)	2-1/2" NST (NH)	UHGV250F
		UHGV250F-D

**Replacement Part**

Description	Part #
handwheel	UHGV250-W

### Single Hydrant Gate Valves with Speed Handle

**Applications**

- Used to throttle the flow from a fire hydrant preventing damage to the hydrant
- For use on hydrants, standpipes, and fire pumps

**Feature**

- Other configurations are available, contact Dixon for additional information

**Materials**

- Pin lug swivel, non-rising stem, aluminum speed handle
- Rubber seal

**Specification**

- Maximum operating pressure: **175 PSI** (water only) at **70°F (21°C)**



Inlet Female	Outlet Male	Cast Red Brass Part #
2-1/2" NST (NH)	2-1/2" NST (NH)	HGV250F
		HGV250F-D
	2-1/2" NPSH	HGV250

**Replacement Part**

Description	Aluminum Part #
speed handle	HGV250-H

N



### Single Hydrant Gate Valves with Handwheel

**Applications**

- Protects fire hydrants from damage that can occur if they are used for throttling
- For use on hydrants, standpipes, and fire pumps

**Specification**

- Maximum operating pressure: 300 PSI (water only) at 70°F (21°C)

**Approval**

- UL listed

**Materials**

- Pin lug swivel, non-rising stem, red handwheel
- Metal to metal seal

Inlet Female	Outlet Male	Forged Brass Part #
2-1/2" NST (NH)	2-1/2" NST (NH)	HGVW250F

**Replacement Part**

Description	Part #
handwheel	HGVW250-W



### Hydrant Gate Valves with Speed Handle

**Application**

- Protects fire hydrants from damage that can occur if they are used for throttling

**Size**

- Full 2-1/2" waterway

**Specification**

- Test pressure: 250 PSI,
- Working pressure: 100 PSI at 70°F (21°C)

**Material**

- Anodized throughout - minimum thickness 0.001"

Inlet Female Swivel	Outlet Male	Aluminum Alloy, 356-T6 Part #
2-1/2" NPSH	2-1/2" NPSH	AHGV250
2-1/2" NST (NH)	2-1/2" NST (NH)	AHGV250F

**Replacement Parts**

Description	Part #
handwheel and knob	HGV-HDWHL
knob only	HGV-KNOB



handwheel and knob

### Global Hydrant Gate Valves with Speed Handle

**Application**

- Protects fire hydrants from damage that can occur if they are used for throttling

**Materials**

- Pin lug swivel, non-rising stem, aluminum speed handle
- Non-metallic seal

**Specification**

- Maximum operating pressure: 175 PSI (water only) at 70°F (21°C)

Inlet Female NST (NH)	Outlet Male NST (NH)	Aluminum Alloy Part #
2-1/2"	2-1/2"	AHGV250F-I

**Replacement Part**

Description	Aluminum Part #
speed handle	AHGV250F-H



## Large Diameter (LDH) Gate Valves

### Application

- Used on the suction intake and discharge sides of a pumper or on a hydrant

### Size

- 4-1/2" minimum waterway

### Features

- 30° elbow needs only eight easy turns to open and close
- Non-rising stem, with an air bleed off

### Material

- Finish anodized throughout - minimum thickness 0.001"

### Specification

- Maximum operating pressure: **280 PSI at 70°F (21°C)**, without relief valve



### Storz x Storz

Inlet Storz	Outlet Storz	Length	Width	Height	Aluminum Alloy, 356-T6 Part #
4"	4"	9"	6-1/4"	19-1/2"	SGV440
	5"		7-3/4"		SGV450
5"	4"	9"	7-3/4"	19-1/2"	SGV540
	5"				SGV550

NOTE: All measurements include handles

### Storz x Storz 30° with Air Bleeder



Inlet Storz	Outlet Storz	Length	Width	Height	Aluminum Alloy, 356-T6 Part #
4"	4"	9"	6-1/4"	20.0"	SGV30-440
	5"		7-3/4"		SGV30-450
5"	4"	9"	7-3/4"	20.0"	SGV30-540
	5"				SGV30-550

NOTE: All measurements include handles

### Storz x Female Swivel



Inlet Storz	Outlet Female NST Swivel	Length	Width	Height	Aluminum Alloy, 356-T6 Part #
4"	4"	9"	6"	19-1/2"	FSGV440F
	4-1/2"		6-1/2"		FSGV445F
	5"		7"		FSGV450F
	6"		8"		FSGV460F
5"	4"	9"	6"	19-1/2"	FSGV540F
	4-1/2"		6-1/2"		FSGV545F
	5"		7"		FSGV550F
	6"		8"		FSGV560F

NOTE: All measurements include handles

N

## Wharf Hydrants

### Application

- Used to provide a fire department outlet connection

### Features

- Pentagon nut at top of spindle discourages unauthorized use
- Hydrostatically tested

### Specification

- Maximum operating pressure: **300 PSI at 70°F (21°C)**

Inlet Female NPT	Outlet Male NST (NH)	Height Open	Height Closed	Cast Brass Part #
3"	2-1/2"	16.38	14.25	WHYD3025F
4"	2-1/2"	16.38	14.25	WHYD4025F
	4-1/2"	18.13	15.63	WHYD4045F



### Replacement Parts

Description	Part #
optional hand wheel	46-030-00025
pentagon hex nut	44-251-00006



hand wheel



pentagon hex nut

## Forestry Grade 1/4 Turn Ball Type Wye Valves

### Material

- Cast aluminum swivel inlet, anodized body, hard-coated threads

### Specification

- 1" and 1-1/2" for use up to **600 PSI** (water/AFFF only); 2-1/2" for use up to **400 PSI** (water/AFFF only)

### Approval

- Built to U.S. Forest Service specifications

Female Thread	(2) Male Threads	Cast Aluminum Part #
1" NPSH	1" NPSH	FWV10S10S
1-1/2" NPSH	1-1/2" NPSH	FWV15S15S
1-1/2" NST (NH)	1-1/2" NST (NH)	FWV15F15F
2-1/2" NST (NH)	1-1/2" NST (NH)	FWV25F15F
	2-1/2" NST (NH)	FWV25F25F



1" - 1-1/2"



2-1/2"



### 1/4 Turn Ball Type Wye Valve



**Features**

- Rocker lug swivel
- Operates easily under high pressure
- Handles are not field replaceable
- Seals on the ball are field adjustable and field replaceable

**Specification**

- Maximum operating pressure: **175 PSI** (water only) at 70°F (21°C)

**Approval**

- Meets NSN specifications # 4210-00-255-0234

Inlet Female	(2) Outlets Male	Cast Brass Part #
2-1/2" NST (NH)	1-1/2" NPSH	S7337S

### Full Flow 1/4 Turn Ball Type Wye Valves

**Application**

- Recommended for charged pre-connected hose lines



**Features**

- Pin lug swivel
- Other configurations are available, contact Dixon® for additional information

**Specification**

- Maximum operating pressure: **175 PSI** (water only) at 70°F (21°C)

Inlet Female Swivel	(2) Outlets Male	Cast Brass Part #
1-1/2" NPSH	1-1/2" NPSH	S7100-15S
1-1/2" NST (NH)	1-1/2" NST (NH)	S7100-15
2-1/2" NST (NH)		S7100

### Leader Line 1/4 Turn Ball Type Wye Valve

N



**Feature**

- Body painted red with chrome trim

**Specification**

- Maximum operating pressure: **400 PSI** (water only) at 70°F (21°C)

Inlet Female NST (NH)	(2) Outlets Male NST (NH)	Brass Part #
2-1/2"	1-1/2"	LLBV2515F

### 1/4 Turn Plug Type Wye Valves

**Features**

- Pin lug swivel
- Not recommended for charged pre-connected hose 

**Specification**

- Maximum operating pressure: **175 PSI** (water only) at 70°F (21°C)

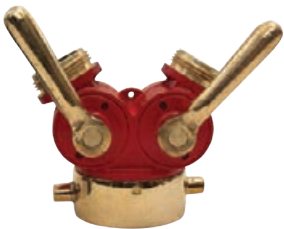

Inlet Female NST (NH)	(2) Outlets Male	Cast Brass Part #
2-1/2"	1-1/2" NST (NH)	S6175
	1-1/2" NPSH	S6175S



## 2-Way Ball Valves

Inlet Female Swivel	(2) Outlet Male	Aluminum Part #
1-1/2" NST (NH)	1-1/2" NST (NH)	FMBV15F15F
1-1/2" NPSH	1-1/2" NPSH	FMBV15S15S
2-1/2" NST (NH)	1-1/2" NST (NH)	FMBV25F15F
	2-1/2" NST (NH)	FMBV25F25F
4" NST (NH)	2-1/2" NST (NH)	FMBV40F25F
4-1/2" NST (NH)	2-1/2" NST (NH)	FMBV45F25F



## Plain Wyes with Pin Lugs

### Features

- Divides one stream into two
- Other configurations are available, contact Dixon® for additional information

Inlet Female	(2) Outlets Male	Cast Brass Part #
1-1/2" NST (NH)	1-1/2" NST (NH)	PW15F15F
1-1/2" NPSH	1-1/2" NPSH	PW15S15S
2-1/2" NST (NH)	1-1/2" NST (NH)	PW25F15F
	2-1/2" NST (NH)	PW25F25F



### Straight Globe Valves



**Applications**

- Used with a fire hose rack assembly, or as a fire department outlet connection
- Ideal for wet and combination systems

**Material**

- Aluminum handwheel

**Specification**

- Maximum operating pressure: **300 PSI at 70°F (21°C)**



**Female x Male**

Inlet Female NPT	Outlet Male NST (NH)	Cast Brass Part #
1-1/2"	1-1/2"	SGV150F
2-1/2"	2-1/2"	SGV250F

**Female x Female**

Inlet Female NPT	Outlet Female NPT	Cast Brass Part #
1-1/2"	1-1/2"	SGVF150
2-1/2"	2-1/2"	SGVF250

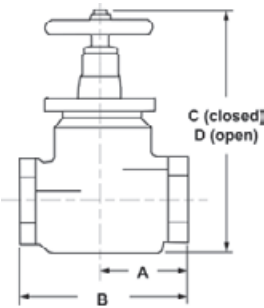

**Dimensions**

Size	A	B	C closed	D open
1-1/2"	2-3/8"	4-3/4"	7-1/4"	8"
2-1/2"	3-9/32"	6-9/16"	7-3/8"	8-1/8"

### Angled Ball Drip Valves

**Feature**

- Seals automatically under pressure

**Specifications**

- Installed horizontally, the ball seats at approximately **8-10 PSI**
- Working pressure: **175 PSI at 70°F (21°C)**

N

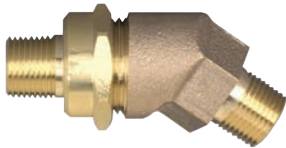

Male NPT	Male NPT	Brass Part #
1/2"	1/2"	ASBDV50
3/4"	3/4"	ASBDV75

### Straight Ball Drip Valves

**Application**

- Designed to drain the low point of a system

**Features**

- Place valve between a fire department connection and a swing check valve
- Seals automatically under pressure
- Install horizontally

**Specification**

- Working pressure: **175 PSI at 70°F (21°C)**



Male NPT	Male NPT	Brass Part #
1/2"	1/2"	SBDV50
3/4"	3/4"	SBDV75

## Factory Set Pressure Reducing Brass Angle Valves

### Features

- True combination shut-off and pressure reducing valves
- Female x female valves have an open / closed indicator bonnet for confirmation of status
- Tamper resistant and automatic
- Available with a tamper proof switch
- All debris must be flushed from the system prior to being placed into service
- Complete switch, bracket, and housing available for field mounting; consult Dixon® for price and availability
- Other configurations are available, contact Dixon for additional information

### Specification

- 1-1/2" reduces inlet pressure of **300 PSI (2069 kPa)** or less to working pressures of **10 through 175 PSI (69-1207 kPa)**; 2-1/2" reduces inlet pressures of **400 PSI (2758 kPa)** or less to working pressures of **20 - 175 PSI (138-1207 kPa)** under discharge or static conditions

### Approvals

- UL listed for Automatic Sprinkler Systems as floor or zone control valves
- Standpipe Systems, Class I, II and III
- Automatic Check Valve for Dual Riser Systems
- Approved by New York City Board of Standards and Appeals, approval # MEA 54-07-E
- Approved by City of Los Angeles and the City of San Francisco (ULC 2½")

#### Female x Male

Inlet Female NPT	Outlet Male NST (NH)	Cast Brass Part #
1-1/2"	1-1/2"	NAPRAV150F-15
		NAPRAV150F-20
		NAPRAV150F-25
		NAPRAV150F-30
		NAPRAV150F-35
2-1/2"	2-1/2"	NAPRAV250F-55
		NAPRAV250F-60
		NAPRAV250F-65
		NAPRAV250F-70
		NAPRAV250F-75
		NAPRAV250F-80

#### Female x Female

Inlet Female NPT	Outlet Female NPT	Cast Brass Part #
1-1/2"	1-1/2"	NAPRAVF150-15
		NAPRAVF150-20
		NAPRAVF150-25
		NAPRAVF150-30
		NAPRAVF150-50
2-1/2"	2-1/2"	NAPRAVF250-55
		NAPRAVF250-60
		NAPRAVF250-65
		NAPRAVF250-70
		NAPRAVF250-75
		NAPRAVF250-80

#### Dimensions

Size	A	B	C	D	E closed	E open
1-1/2"	2-7/32"	4-5/32"	3-7/8"	3-3/4"	9-25/64"	8-53/64"
2-1/2"	3-7/32"	6-3/32"	5-3/4"	5-3/4"	11-3/8"	10-13/16"

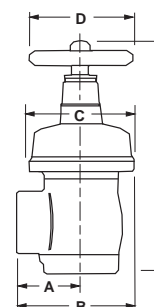

N



## Factory Set Pressure Reducing Brass Standard Globe Valve

Approval  
 • UL listed



### Female x Female

Inlet Female NPT	Outlet Female NPT	Cast Brass Part #
2-1/2"	2-1/2"	NAPRVF250-55
		NAPRVF250-60
		NAPRVF250-65
		NAPRVF250-70
		NAPRVF250-75
		NAPRVF250-80



### Grooved x Grooved

Inlet Grooved	Outlet Grooved	Cast Brass Part #
2-1/2"	2-1/2"	NAPRVGT250-55
		NAPRVGT250-60
		NAPRVGT250-65
		NAPRVGT250-70
		NAPRVGT250-75

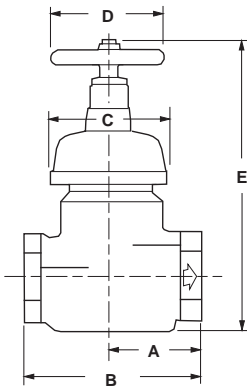

### Dimensions

Size	Style	A	B	C	D	E closed	E open
2-1/2"	NPT	3-7/8"	7-3/4"	5-3/4"	5-3/4"	12-3/4"	12-13/16"
	grooved	4-3/8"	8-3/4"				

### Accessories

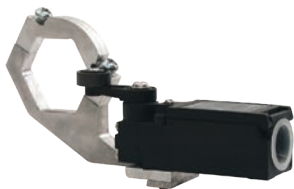

Description	Part #
2-1/2" tamper switch bracket kit (bonnet, nut, switch, bracket)	4201901587
switch bracket only	18-458-00017
replacement handles for 1-1/2" valves	AV150-W
replacement handles for 2-1/2" valves	46-030-00025

N



## Factory Set Pressure Reducing (regulating) Valves

**Feature**

- (4) drilled and tapped bosses:
  - two on each side for upstream and downstream pressure monitoring
  - saves installation time and provides a cleaner appearance
- Tamper switch available

**Specification**

- 2-1/2" size reduces inlet pressures of **400 PSI (2758 kPa)** or less to desired working pressures from **20 - 175 PSI (138-1207 kPa)** under discharge or static conditions

**Approval**

- UL listed

**Angle Grooved x Grooved**

Inlet Grooved	Outlet Grooved	Cast Brass Part #
2-1/2"	2-1/2"	NAPRAVGT250-55
		NAPRAVGT250-60
		NAPRAVGT250-65
		NAPRAVGT250-70
		NAPRAVGT250-75
		NAPRAVGT250-80
		NAPRAVGT250-85
		NAPRAVGT250-95

**Angle Grooved x Female**

Inlet Grooved	Outlet Female NPT	Cast Brass Part #
2-1/2"	2-1/2"	NAPRAVGFT250-55
		NAPRAVGFT250-60
		NAPRAVGFT250-65
		NAPRAVGFT250-70
		NAPRAVGFT250-75
		NAPRAVGFT250-80
		NAPRAVGFT250-85
		NAPRAVGFT250-95

**Globe Female x Female**

Inlet Female NPT	Outlet Female NPT	Cast Brass Part #
2-1/2"	2-1/2"	NAPRVFT250-55
		NAPRVFT250-60
		NAPRVFT250-65
		NAPRVFT250-70
		NAPRVFT250-75
		NAPRVFT250-80
		NAPRVFT250-85

**Globe Grooved x Grooved**

Inlet Grooved	Outlet Grooved	Cast Brass Part #
2-1/2"	2-1/2"	NAPRVGT250-55
		NAPRVGT250-60
		NAPRVGT250-65
		NAPRVGT250-70
		NAPRVGT250-75
		NAPRVGT250-80
		NAPRVGT250-85



**Dimensions**

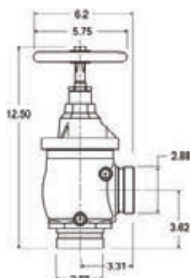

grooved x grooved angle valve

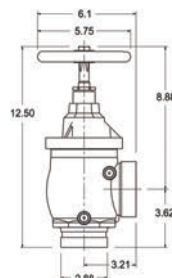

grooved x female angle valve

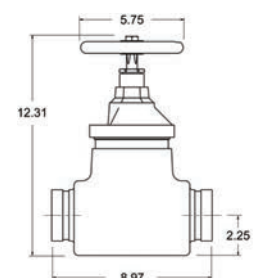

grooved x grooved globe valve



### Field Adjustable Pressure Reducing Valves

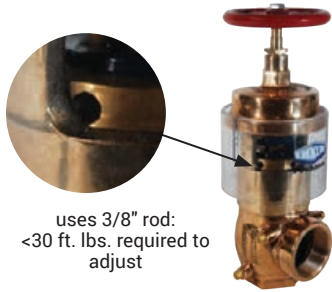

uses 3/8" rod:  
<30 ft. lbs. required to adjust

**Features**

- 3/8" adjusting rod included
- Allows flexibility during installation with the ability to adjust settings once installed as hydraulic conditions change

**Specifications**

- Used in applications where the inlet pressure is greater than 175 PSI
- 1/4" NPT gauge ports - both sides, drilled and tapped standard

**Approval**

- UL listed

**Angle Valves**

Inlet	Outlet	Cast Brass Part #
2-1/2" FNPT	2-1/2" MNST	FAPRAV250F
	2-1/2" FNPT	FAPRAVF250
2-1/2" groove	2-1/2" MNST	FAPRAVG250F
	2-1/2" groove	FAPRAVG250G

**Straight Valves**

Inlet	Outlet	Cast Brass Part #
2-1/2" groove	2-1/2" groove	FAPRVG250
2-1/2" FNPT	2-1/2" FNPT	FAPRVF250

**Replacement Parts**

Description	Cast Iron Part #
handwheel	46-030-00025

**Setting Instructions**

1. Determine desired outlet pressure for known inlet pressure.
2. Remove the tamper-resistant screw and slide the plastic cover up to access the adjusting nut.
3. Use a 3/8" diameter rod in any one of the six holes in the adjusting nut and rotate counter clockwise to increase the pressure at the outlet.
4. Check valve under pressure under static and under the anticipated flowing conditions to ascertain that the setting produces the expected results.

### Adjustable Pressure Restricting Devices

**Application**

- For installation on Class I or Class III standpipe system hose outlets

**Specification**

- Working pressure: 175 PSI at 70°F (21°C)

**Feature**

- Device restricts pressure in the piping system to such a degree that hose lines can be handled by persons untrained in the handling of heavy fire streams

**Approvals**

- New York City Board of Standards and Appeals, approval # MEA 54-07-E
- 2-1/2" UL listed, ULC approved



Female Thread	Male Thread	UL Listed	Cast Brass Part #
1-1/2" NST (NH)	1-1/2" NST (NH)	no	APRD150F
2-1/2" NST (NH)	2-1/2" NST (NH)	yes	APRD250F

N





## Domestic Adjustable Pressure Restricting Angle Valves

### Application

- Used where flowing water pressure needs to be controlled

### Features

- Restricting valve has no effect on the static pressure of a system
- Can be manually bypassed if required by opening the valve fully, this is accomplished by breaking the breakable link, which allows the valve stem to rise to the full open position
- Breakable link also serves as an indication of valve condition and status; if valve is opened without breaking the link it will resume its previous position and no resetting is necessary
- Restricts only under flow conditions
- Setting charts are packed with valve
- Aluminum handwheel
- Other configurations are available, contact Dixon® for additional information

### Specifications

- Maximum operating pressure: up to **175 PSI**
- Preset orifices restrict the volume of water thereby lowering the pressure of the flowing water; NFPA requires restricting valves where inlet pressure exceeds **100 PSI**
- Restricts inlet pressure from **70 PSI** up to a maximum of **175 PSI**
- Restricts down to outlet pressures of **65, 80, or 100 PSI**, outlet pressures may be set below **65 PSI** when authorized by the local authority having jurisdiction

### Approvals

- UL listed
- New York City Board of Standards and Appeals, approval # MEA 54-07-E

#### Female x Male

Inlet Female NPT	Outlet Male NST (NH)	Cast Brass Part #
1-1/2"	1-1/2"	AVAPR150F
2-1/2"	2-1/2"	AVAPR250F

#### Female x Female

Inlet Female NPT	Outlet Female NPT	Cast Brass Part #
1-1/2"	1-1/2"	AVAPRF150
2-1/2"	2-1/2"	AVAPRF250



## Global Adjustable Pressure Restricting Angle Valves

### Application

- Used when flowing water pressure needs to be controlled

### Features

- Restricting valve has no effect on the static pressure of a system
- Restricting device can be manually bypassed if required by opening the valve fully: pull the pin allowing the yoke to fall back from the valve stem, which allows valve to be fully opened. When valve needs to be restricted again, slide the yoke back into place to be NFPA compliant

### Specification

- Preset orifices restrict the volume of water, thereby lowering the pressure of the flowing water; NFPA requires restricting valves where inlet pressure exceeds **100 PSI**

#### Female x Male

Inlet Female NPT	Outlet Male NST (NH)	Cast Brass Part #
1-1/2"	1-1/2"	AVAPR150F-I
2-1/2"	2-1/2"	AVAPR250F-I

#### Female x Female

Inlet Female NPT	Outlet Female NPT	Cast Brass Part #
1-1/2"	1-1/2"	AVAPRF150-I
2-1/2"	2-1/2"	AVAPRF250-I



N





### Backflow Preventer

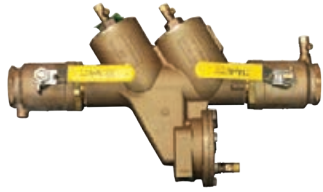

**Features**

- Provides maximum protection against backflow caused by back-pressure or back-siphonage from a cross-connection wherein a contaminant hazard exists
- Consists of two spring-loaded poppet type check valves and a mechanically independent, hydraulically dependent pressure differential relief valve
- Three top-mounted test cocks ensure easy access during repair and maintenance
- Create a fire hydrant backflow preventer by using the RSMSA25F20T (page 809) and the DMH2025F (page 811)

**Specifications**

- Working pressure: to **175 PSIG**
- Temperature range: **33°F to 180°F (.5°C to 82°C)**

**Approvals**

- Meets Foundation for Cross Connection Control and Hydraulic Research at University of Southern California Manual Section 10, ASSE 1015, AWWA C-510 and CSA B64.4 specifications
- UL listed and FM approved

NPT Thread	Brass Part #
2"	BFP200

### Chicago Pattern Valves



**Material**

- Aluminum handwheel

**Specification**

- Maximum operating pressure: **175 PSI at 70°F (21°C)**

Inlet Male NPT	Outlet Male	Cast Brass Part #
1-1/2"	1-1/2" NST (NH)	CPV150F

N



### Sprinkler Hose Valve



**Material**

- Aluminum wheel

**Specification**

- Working pressure: 175 PSI (water only) at 70°F (21°C)

**Approvals**

- UL listed and FM approved for automatic sprinkler and standpipe systems



Inlet Male NPT	Outlet Male NST (NH)	Cast Brass Part #
1"	1-1/2"	ASHV1015F

### Push Pull Drain Valve

**Size**

- 2-1/2" handle length

**Feature**

- Direct mount



Inlet	Outlet	Brass Part #
3/4" FNPT	3/4" FNPT	PPDV75

### Automatic Drain Vent Valve

**Application**

- Attaches to the hose end of a hose rack nipple keeping the hose free of moisture by draining water from a leaky valve; when the valve is opened for use a spring valve closes the drain and directs all water through the hose

**Feature**

- Other threads and finishes are available, consult Dixon® for more information



Female NST (NH)	Male NST (NH)	Working Pressure (PSI)	Cast Brass Part #
1-1/2"	1-1/2"	175	ADV150F



### Piston Intake Relief Valves

**Size**

- 4-1/2" minimum waterway

**Features**

- Standard with a 30° elbow (permitting smoother water flow), adjustable relief valve, retractable knob on hand wheel, and air bleed off
- Permits safe controlled flow to the intake pump and can also be used to draft
- Nine easy turns open and close the valve

**Material**

- Finish anodized throughout - minimum thickness 0.001"

**Specifications**

- 280 PSI at 70°F (21°C), without relief valve
- Relief valve - double spring, cartridge type, adjustable from 50 to 200 PSI

**Storz x Female Swivel**



Storz	Female Swivel NST (NH)	Length	Width	Height	Aluminum Alloy, 356-T6 Part #
4"	4"	12"	8"	17"	FSGR440F
	4-1/2"				FSGR445F
	5"				FSGR450F
	6"				FSGR460F
5"	4"	12"	8"	17"	FSGR540F
	5"				FSGR550F
	6"				FSGR560F

**Female Swivel x Male**

N



Male NST (NH)	(2) Female NST (NH) Swivel	Length	Width	Height	Aluminum Alloy, 356-T6 Part #
4"	4"	12"	8"	17"	FMGR40F40F
	4-1/2"				FMGR40F45F
	5"				FMGR40F50F
	6"				FMGR40F60F
4-1/2"	4"	12"	8"	17"	FMGR45F40F
	4-1/2"				FMGR45F45F
	5"				FMGR45F50F
	6"				FMGR45F60F
5"	4"	12"	8"	17"	FMGR50F40F
	4-1/2"				FMGR50F45F
	5"				FMGR50F50F
	6"				FMGR50F60F
6"	6"	12"	8"	17"	FMGR60F60F

**Replacement Parts**



PV-HDWHL

Description	Part #
handwheel and knob	PV-HDWHL
knob only	PV-KNOB

**Fire Specialty Products**

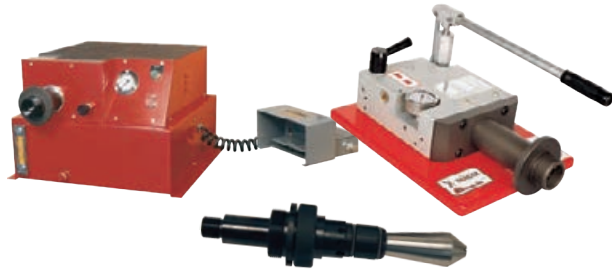

**Fire Hose Coupling Machines and Accessories**



**Low Level Strainer - Floating Strainer**



**Dry Hydrants**



**Barrel and Basket Strainers**



**Booster Hose Installation Kit**



**Suction Hoses**



**Partial Listing of Powder Coating Colors Available for Wrenches**

Contact Dixon Fire at 877.712.6179 for more information.

					
Black	Dark Blue	Medium Blue	Gray	Red	Orange
					
Mustard	Yellow	Green	Aqua	Plum	Pink

**Ball.....875 - 899**

Domestic.....875  
 Full port.....875  
 Locking handle.....876  
 Bronze.....876  
 Deadman spring return.....876  
 250 Lb. steam.....877  
 Safety vented.....877  
 NPT tap for drain.....877  
 Imported.....878  
 Imported with locking handle.....878  
 Global.....879  
 Solder end.....879  
 Lead-free brass.....879  
 Dual Y.....880  
 Mini.....880  
 3-Way diverting T flow.....881  
 3-Way diverting L flow.....881  
 2-Piece stainless.....882  
 Stainless full port.....882  
 Stainless full port with locking handle.....883  
 Stainless reduced port with locking handle.....883  
 3-Piece stainless.....884  
 3-Piece socket weld.....884  
 Deadman spring return stainless.....884  
 Electrically actuated stainless.....885  
 Electrically actuated brass.....886  
 Electrically actuated 3-way 'T / L' port.....887  
 Pneumatically actuated stainless.....888  
 Pneumatically actuated brass.....889  
 Pneumatically actuated 3-way stainless 'T / L' port.....890  
 Pneumatically actuated 3-way brass 'T / L' port.....891  
 Pneumatically actuated wafer butterfly valves.....892  
 BV3/4 stainless ball.....893  
 Actuated valve accessories.....894  
 Dixon® manntek full flow.....895 - 896  
 Carbon steel ball.....896  
 High pressure full-bore 3-way.....897  
 High pressure clear zinc.....897  
 High pressure full-bore.....897  
 150# Flanged.....898  
 Polypropylene bolted.....898  
 Polypropylene compact bolted.....899  
 Polypropylene 45° single union nozzle.....899  
 Polypropylene bolted with nozzle.....899  
 Polypropylene single union.....899

**Gate..... 900**

Domestic bronze gate.....900  
 Stainless steel gate.....900  
 Forged steel gate.....900

**Globe..... 901**

Domestic bronze globe.....901  
 Forged steel globe.....901

**Butterfly .....902 - 903**

Betts Wet-R-Dri™.....902  
 Ductile iron.....903

**Flow Control.....904 - 905**

Steel series F.....904  
 Brass series F.....904  
 Series MV.....904  
 Steel series N.....905  
 Brass series N.....905

**Needle.....906 - 907**

Mini.....906  
 Multiport.....906  
 Block and bleed.....907  
 Bleed.....907

**Air .....908 - 909**

Button.....908  
 Tank filler.....908  
 Brass lever external drains.....908  
 Brass external drain cocks.....908  
 Needle.....909

**Safety.....910 - 914**

Safety check.....910  
 Safety pop-off.....911  
 Series C check.....912  
 Domestic ball cone check.....912  
 800 PSI stainless steel check.....913  
 Forged steel check.....913  
 Spring-loaded check.....913  
 Strainer with spring-loaded check.....914  
 Swing check.....914  
 Domestic swing check.....914

**Drum .....915 - 916**

Drum plug wrenches.....915  
 Drum faucets.....915  
 Compression bibb faucets.....915  
 Drum thread adapters.....916  
 Drum gate valves.....916  
 Self-closing gate valves.....916



## Domestic Bronze Ball Valves

### Application

- For control of air, water, oil, and gas in hose or pipe lines. For other services, please contact Dixon®

### Features

- Blowout-proof stems
- Full and standard port valves are repairable

### Materials

- Bronze valve bodies, balls, and stems
- Glass-filled reinforced PTFE seats and stuffing box ring; stem seals and washers
- Plated steel handles and nuts with vinyl sleeves. Replacements available, contact Dixon for pricing



### Specification

- Pressure rating: **600 PSI CWP**; **150 PSI** saturated steam

### Approval

- Meets WW-V 35C, Type II Composition

Female NPT	Port	Bronze Part #
1/4"	full	BBV25
3/8"		BBV38
1/2"		BBV50
3/4"	standard	BBV75
1"		BBV100
1-1/4"		BBV125
1-1/2"		BBV150
2"		BBV200
2-1/2"		BBV250
3"		BBV300

## Domestic Full Port Bronze Ball Valves

### Features

- Adjustable packing
- Blow-out proof stem design

### Materials

- Machined solid chrome-plated ball
- Multi-fill RPTFE seats and seals

### Specifications

- Vacuum service to 29 inches Hg
- Pressure rating: **600 PSI CWP**; **150 PSI** saturated steam

Female NPT	Port	Bronze Part #
3/4"	full	BBV75FP
1"		BBV100FP
1-1/4"		BBV125FP
1-1/2"		BBV150FP
2"		BBV200FP



## Locking Handle Bronze Ball Valves

### Application

- For control of air, water, oil, and gas in hose or pipe lines. For other services, please contact Dixon®

### Features

- Blow-out proof RPTFE stem
- Full and standard port valves are repairable

### Materials

- Chrome-plated bronze ball
- Stainless steel sliding lock mechanism secures handle in open or closed position; can be padlocked opened or closed
- Plated steel handles and nuts with vinyl sleeves

### Specification

- Pressure rating: **600 PSI CWP; 150 PSI** saturated steam

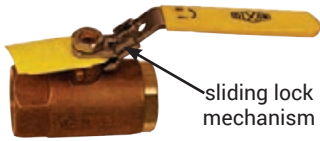

sliding lock mechanism

Female NPT	Port	Bronze Part #
1/4"	full	BBLV25
3/8"		BBLV38
1/2"		BBLV50
3/4"	standard	BBLV75
1"		BBLV100
1-1/4"		BBLV125
1-1/2"		BBLV150
2"		BBLV200

## Bronze Ball Valves

### Applications

- For air, water, oil, and gas service

### Materials

- Chromium plated ball
- RTFE seats and stuffing box ring

### Features

- Blow-out proof stem
- Adjustable packing gland

### Specification

- Pressure rating: **600 PSI**
- Cold non-shock pressure rating: **150 PSI** saturated steam



Male NPT x Female NPT	Port	Bronze Part #
1/2"	standard	BMV50
3/4"	standard	BMV75
1"	standard	BMV100

0

## "Deadman" Spring Return Handle Brass Ball Valves

### Features

- Blow-out proof stem design
- Adjustable packing gland
- Spring return closes valve when not held open

### Specification

- Operating torque approximately three times standard valve torque
- Pressure rating: **600 PSI CWP; 150 PSI** saturated steam
- Vacuum service to 29 inches Hg

### Materials

- Stainless steel lever
- Chromium plated ball
- RTFE seats and stuffing box ring



Female NPT	Port	Brass Part #
1/2"	full	BBV50SR
3/4"	standard	BBV75SR
1"		BBV100SR
1-1/2"		BBV150SR
2"		BBV200SR

## 250 Lb. Steam Ball Valves

### Application

- Recommended for use with fluids with widely varying temperatures and/or thermal expansion rates

### Material

- 316 stainless steel ball and stem

### Features

- Blow-out proof stem design
- Multi-fill RPTFE seats
- Multi-fill stuffing box ring
- High temperature MTFE stem packing
- Adjustable packing gland

### Specifications

- Maximum temperature: **450°F (232°C)**
- Pressure rating: **600 PSI; 250 PSI** saturated steam
- Vacuum service to 29 inches Hg



Female NPT	Port	Bronze Part #
1/2"	full	BBV50ST
3/4"	standard	BBV75ST
1"		BBV100ST
2"		BBV200ST

## Safety Vented Ball Valves

### Application

- For air service only



### Materials

- Chromium plated ball
- RTFE seats and stuffing box ring

### Features

- Blow-out proof stem design
- Adjustable packing gland
- Vent downstream air in accordance with OSHA regulation 1910.147 for pneumatic systems

### Specification

- Pressure rating: **0-125 PSI**



sliding lock mechanism

Female NPT	Port	Bronze Part #
1/4"	full	BBV25LV
3/8"		BBV38LV
1/2"		BBV50LV
3/4"	standard	BBV75LV
1"		BBV100LV
1-1/4"		BBV125LV
1-1/2"		BBV150LV
2"		BBV200LV

## Bronze Ball Valves with NPT Tap for Drain

### Application

- Recommended for water and air service

### Materials

- RTFE seats and stuffing box ring
- Chromium plated ball

### Features

- Blow-out proof stem
- Adjustable packing gland
- Auto-drain / auto-vent
- 1/4" NPT tapped port provides additional options such as an air venting elbow or noise muffler
- Vent downstream air in accordance with OSHA regulations for pneumatic systems

### Specification

- Pressure rating: **125 PSI CWP**



Female NPT	Port	Bronze Part #
1/4"	full	BBV25VT
3/8"		BBV38VT
1/2"		BBV50VT
3/4"		BBV75VT
1"		BBV100VT

### Imported Brass Ball Valves

**Application**

- For control of air, water, oil, and gas in hose or pipe lines, for other services, please contact Dixon®

**Features**

- Blow-out proof stems

**Materials**

- PTFE seat, seal and thrust washer
- Chrome-plated brass ball and plated steel handle

**Specifications**

- Maximum temperature: **366°F (186°C)**
- Pressure rating: **600 PSI WOG; 150 PSI Working Steam Pressure**

**Approval**

- UL listed



**Female NPT x Female NPT**



Size	Port	Forged Brass Part #
1/4"	full	FBV25
3/8"		FBV38
1/2"		FBV50
3/4"		FBV75
1"		FBV100
1-1/4"		FBV125
1-1/2"		FBV150
2"		FBV200

**Female NPT x Female NPT**



Size	Port	Forged Brass Part #
2-1/2"	full	FBV250
3"		FBV300
4"		FBV400

### Imported Brass Ball Valves with Locking Handle

**Application**

- For control of air, water, oil and gas in hose or pipe lines, for other services please contact Dixon®

**Features**

- Blow-out proof stem

**Materials**

- PTFE seat, seal, and thrust washer
- Chrome-plated brass ball and plated steel handle

**Specifications**

- Maximum temperature: **366°F (186°C)**
- Pressure ratings: **600 PSI WOG; 150 PSI working steam pressure**

0



Female NPT	Port	Forged Brass Part #
1/2"	full	FBVL50
3/4"		FBVL75
1"		FBVL100
1-1/4"		FBVL125
1-1/2"		FBVL150
2"		FBVL200
2-1/2"		FBVL250
3"		FBVL300
4"		FBVL400



## Global Brass Ball Valves

### Application

- For water and air only



### Specifications

- Pressure ratings
  - 1/4" - 3/8" rated to **365 PSI**
  - 1/2" - 2" rated to **600 PSI**
- Maximum temperature: **248°F (120°C)**

Female NPT	Port	Forged Brass Part #
1/4"	full	FBVG25
3/8"		FBVG38
1/2"		FBVG50
3/4"		FBVG75
1"		FBVG100
1-1/4"		FBVG125
1-1/2"		FBVG150
2"		FBVG200



## Solder End Brass Ball Valves

### Application

- Provides protection against potential gas leakage under extreme duty or low pressure applications

### Materials

- Chrome-plated brass ball
- PTFE seat, seal, and thrust washer

### Features

- Blow-out proof stem
- Adjustable stem packing nut

### Specifications

- Pressure rating: **600 PSI WOG; 150 PSI** working steam pressure
- Maximum temperature: **366°F (186°C)**

Size	Port	Brass Part #
1/2"	full	FBV50SE
3/4"		FBV75SE
1"		FBV100SE
1-1/4"		FBV125SE
1-1/2"		FBV150SE
2"		FBV200SE



## Lead-Free Brass Ball Valves

### Feature

- PTFE seat and double O-ring stem packing

### Specifications

- Pressure rating: **600 WOG - 150 WSP**
- Maximum temperature: **366°F (186°C)**

### Approvals

- Lead-free refers to the wetted surface of pipes, fittings, and fixtures in potable water systems that have a weighted average lead content = 0.25% Source: California Health & Safety Code (116875). Vermont Act 193\*171NLF

Female NPT	Port	Lead-Free Brass Part #
1/2"	full	LFV50
3/4"		LFV75
1"		LFV100
1-1/4"		LFV125
1-1/2"		LFV150
2"		LFV200



### Dual Y Valves

**Application**

- Ideal for compressor applications

**Feature**

- Dual action valve

**Specifications**

- Non-vented pressure rating: **600 PSI CWP**
- Vented pressure rating: **125 PSI CWP**



**Vented**

Female NPT Inlet (1)	Female NPT Outlets (2)	Bronze Part #
1"	3/4"	BBV100DWV
1-1/4"		BBV125DWV

**Non-Vented**

Female NPT Inlet (1)	Female NPT Outlets (2)	Bronze Part #
1"	3/4"	BBV100DW
1-1/4"		BBV125DW



### Mini Ball Valves

**Feature**

- Blow-out proof stem

**Material**

- PTFE seats and FKM stem seal

**Specifications**

- Maximum temperature **330°F (166°C)**
- Pressure rating: **450 PSI**



**Approval**

- Canadian Standard Association approved

Female NPT	Port	Nickel Plated Brass Part #
1/8"	standard	MBV12
1/4"		MBV25
3/8"		MBV38
1/2"		MBV50

### 3-Way Brass Diverting Ball Valves - T Flow

Female NPT x Female NPT x Female NPT

**Features**

- Blow-out proof stem
- Adjustable stem packing

**Materials**

- Chrome plated brass ball
- PTFE seats, seals, and thrust washer

**Specifications**

- Maximum temperature: **366°F (186°C)**
- Pressure rating: **400 PSI WOG; 100 PSI saturated steam**

Size	Port	Brass Part #
1/2"	standard	BBV50DTW
3/4"		BBV75DTW
1"		BBV100DTW
1-1/4"		BBV125DTW
1-1/2"		BBV150DTW
2"		BBV200DTW

NOTE: 1/4 turn handle can be adjusted to any orientation. Notches on the valve stem reflect the three openings on the ball.

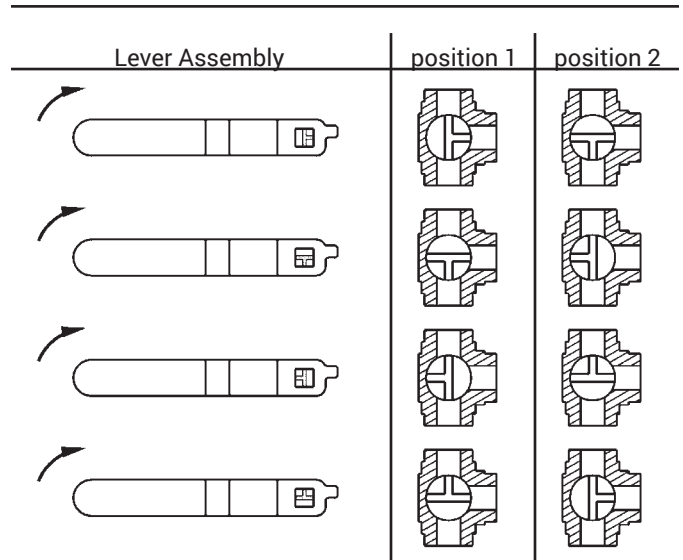

### 3-Way Brass Diverting Ball Valves - L Flow

Female NPT x Female NPT x Female NPT

**Features**

- Can be used with gasoline and diesel fuel
- Blow-out proof stem
- Adjustable packing gland

**Materials**

- Chromium-plated ball
- RPTFE seats and stuffing box ring
- Stainless steel handle and nut with vinyl sleeve

**Specification**

- Pressure rating: **400 PSI CWP**

Size	Port	Bronze Part #
1/2"	full	BBV50TW <sup>1</sup>
3/4"	standard	BBV75TW
1"		BBV100TW

<sup>1</sup> Carbon steel handle and nut with vinyl sleeve

**Features**

- Blow-out proof stem
- Adjustable packing gland

**Materials**

- Stainless steel ball
- RPTFE seats and stuffing box ring
- Stainless steel handle and nut with vinyl sleeve

**Specification**

- Rated to **800 PSI CWP**

**Approval**

- Meets NACE MR0175

Size	Port	Stainless Steel Part #
1/2"	full	SSBV50TW
3/4"	standard	SSBV75TW
1"		SSBV100TW

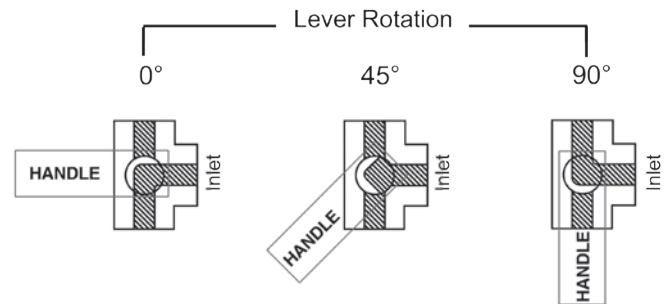

## 2-Piece Domestic Stainless Steel Ball Valves

### Feature

- Blow-out proof stem

### Materials

- 316 stainless ball and stem
- RPTFE seal
- Vinyl handle cover

### Specifications

- Temperature range: **-40°F to 400°F (-40°C to 204°C)**
- Pressure rating: **1,000 PSI CWP**
- Pressure rating: **150 PSI saturated steam**
- Vacuum service to 29 inches Hg



Female NPT	Port	316 Stainless Steel Part #
1/4"	full	DSBV25
3/8"		DSBV38
1/2"		DSBV50
3/4"		DSBV75
1"		DSBV100
1-1/4"		DSBV125
1-1/2"		DSBV150
2"		DSBV200

## Stainless Steel Ball Valves Full Port

### Applications

- For use with water, oil, and gas

### Feature

- Blow-out proof stem design

### Materials

- 316 stainless steel ball and stem
- RPTFE seat, joint gasket, and thrust washer

### Specifications

- Temperature range: **-20°F to 300°F (-29°C to 149°C)** as long as the valve is run fully open/closed
- Pressure rating:
  - 1/4" - 2" rated to **1000 PSI WOG (CWP)**
  - 2-1/2" - 3" rated to **800 PSI WOG (CWP)**
  - 100 PSI saturated steam**



Female NPT	Port	316 Stainless Steel Part #
1/4"	full	SSBV25
3/8"		SSBV38
1/2"		SSBV50
3/4"		SSBV75
1"		SSBV100
1-1/4"		SSBV125
1-1/2"		SSBV150
2"		SSBV200
2-1/2"		SSBV250
3"		SSBV300

## Full Port Ball Valves with Locking Handle

### Applications

- For use with water, oil, and gas

### Features

- Lockable
- Blow-out proof stem design
- Not recommended as a throttling valve

### Materials

- 316 stainless steel ball and stem
- RPTFE seat, joint gasket and thrust washer
- Plastic cover on handle

### Specifications

- Temperature range: **-20°F to 356°F (-29°C to 180°C)**
- Pressure rating: 1/4" - 2" rated to **1000 PSI WOG (CWP)**  
2-1/2" - 3" rated to **800 PSI WOG (CWP)**  
**100 PSI saturated steam**

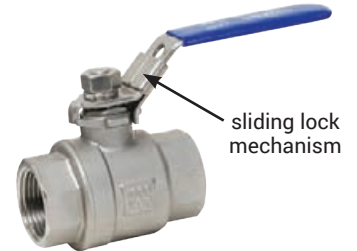

Female NPT	Port	316 Stainless Steel Part #
1/4"	full	SSLBV25
3/8"		SSLBV38
1/2"		SSLBV50
3/4"		SSLBV75
1"		SSLBV100
1-1/4"		SSLBV125
1-1/2"		SSLBV150
2"		SSLBV200
2-1/2"		SSLBV250
3"		SSLBV300

## Reduced Port Ball Valves with Locking Handle

### Applications

- For use with water, oil, and gas

### Features

- Lockable
- Blow-out proof stem design
- Not recommended as a throttling valve

### Materials

- 316 stainless steel ball and stem
- RPTFE seat, joint gasket, and thrust washer
- Plastic cover on handle

### Specifications

- Temperature range: **-20°F to 356°F (-29°C to 180°C)**
- Pressure rating: **1000 PSI WOG; 100 PSI saturated steam**

Female NPT	Port	316 Stainless Steel Part #
1/4"	reduced	SSLBV25SP
3/8"		SSLBV38SP
1/2"		SSLBV50SP
3/4"		SSLBV75SP
1"		SSLBV100SP
1-1/4"		SSLBV125SP
1-1/2"		SSLBV150SP
2"		SSLBV200SP

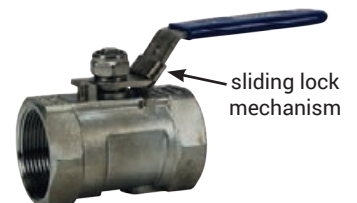

### 3-Piece Industrial Stainless Steel Ball Valves FNPT

**Features**

- Blowout-proof stem
- Live-loaded stem packing
- Swing out design for easy maintenance
- ISO 5211 mounting pad
- RTFE seat and seals

**Specifications**

- Maximum temperature: **400°F (200°C)**
- Maximum pressure: 1/4" - 1/2" **1,000 PSI WOG** at 65°F, 2-1/2" - 3" **800 PSI WOG** at 65°F, 4" **600 PSI WOG** at 65°F



Female NPT	Port	PSI @ 65°F	Body Length	CF8M Stainless Steel Part #
1/2"	full	1000	2.8"	BV2IGN05011-A
3/4"			3.1"	BV2IGN07511-A
1"			3.3"	BV2IGN10011-A
1-1/4"			4.1"	BV2IGN12511-A
1-1/2"			4.4"	BV2IGN15011-A
2"			5.1"	BV2IGN20011-A
2-1/2"		800	6.6"	BV2IGN25011-A
3"		7.3"	BV2IGN30011-A	
4"		600	8.9"	BV2IGN40011-A

### 3-Piece Industrial Stainless Steel Ball Valves Socket Weld



Female NPT	Port	PSI @ 65°F	Body Length	CF8M Stainless Steel Part #
1/2"	full	1000	2.8"	BV2IGN05033-A
3/4"			3.1"	BV2IGN07533-A
1"			3.3"	BV2IGN10033-A
1-1/4"			4.1"	BV2IGN12533-A
1-1/2"			4.4"	BV2IGN15033-A
2"			5.1"	BV2IGN20033-A
2-1/2"		800	6.6"	BV2IGN25033-A
3"		7.3"	BV2IGN30033-A	
4"		600	8.9"	BV2IGN40033-A

0

### "Deadman" Spring Return Handle Stainless Steel Ball Valves

**Features**

- PTFE seal
- Blow-out proof stem design
- Adjustable packing gland
- Spring return closes valve when not held open

**Specifications**

- Operating torque approximately three times standard valve torque
- Pressure rating: **2000 PSI WOG** 1/2" to 1"; **1500 PSI WOG** 1-1/4" to 2"
- **150 PSI** saturated steam, all sizes
- Vacuum service to 29 inches Hg, all sizes



Female NPT	Port	316 Stainless Steel Part #	
1/2"	full	SSBV50SR	
3/4"		SSBV75SR	
1"		SSBV100SR	
1-1/4"		standard	SSBV125SR
1-1/2"			SSBV150SR
2"			SSBV200SR

## Electrically Actuated Stainless Steel Ball Valves

### 2-Piece

#### 2-Piece Stainless Steel Ball Valve

##### Feature

- Blow-out proof stem

##### Materials

- Body, ends and ball: CF8M stainless
- Seats: RTFE
- Seals: PTFE
- ISO 5211 mounting pad

##### Specifications

- Pressure rating:
  - 1/4" - 2": **1000 PSI WOG**,
  - 2-1/2" - 3": **800 PSI WOG**
- Temperature range:
  - **-40°F to 350°F (-40°C to 177°C)**

#### Electric Actuator

##### Features

- H-insulation class
- Visual position indication
- Space heater is standard
- NEMA 4/4X waterproof and dustproof

##### Materials

- Gear train: high alloy steel
- Housing: lightweight powder coated aluminum alloy

##### Specifications

- Temperature range: **-41°F to 140°F (-41°C to 60°C)**

##### Approvals

- ISO 9001, CS, CE and CSA-C US Certified
- RoHS compliant



### 3-Piece

#### 3-Piece Stainless Steel Ball Valve

##### Features

- Blow-out proof stem
- Live-loaded stem packing
- Swing out design allows easy maintenance

##### Materials

- Body and ball: CF8M stainless steel
- Stem: 316 stainless steel
- Seat: RTFE
- ISO 5211 mounting pad

##### Specifications

- Maximum pressure:
  - 1/4" - 2": **1,000 PSI WOG at 65°F**
  - 2-1/2" - 3": **800 PSI WOG at 65°F**
  - 4" **600 PSI WOG at 65°F**
- Temperature range:
  - **-40°F to 400°F (-40°C to 204°C)**

#### Electric Actuator

##### Features

- H-insulation class
- Visual position indication
- Space heater is standard
- NEMA 4/4X waterproof and dustproof

##### Materials

- Gear train: high alloy steel
- Housing: lightweight powder coated aluminum alloy

##### Specification

- Temperature range: **-41°F to 140°F (-41°C to 60°C)**

##### Approvals

- ISO 9001, CS, CE, and CSA-C US Certified
- RoHS compliant



A wide variety of options are available: voltages, modulating, extra switches, transmitters, potentiometer, etc. Contact Dixon® Sanitary at 800.789.1718.

Even though there are torque safety factors built into our automated ball valve packages, actual service conditions must also be considered when selecting the proper product for the appropriate application. For example: Severe service conditions such as dirty water, dirty air, all slurries, raw sewage water, oils, and other viscous fluids can have a dramatic effect in raising the torque requirements of ball valves as much as 75% and therefore larger actuators may be required. Please consult Dixon when dealing with these types of applications.



## Electrically Actuated Brass Ball Valves



### 2-Piece Brass Ball Valve

#### Size

- 1/4" to 2" brass; 2-1/2" to 4" bronze

#### Features

- Stem: blow-out proof brass
- ISO 5211 mounting pad

#### Materials

- Elastomers: FKM
- Seats: PTFE with double O-ring stem packing

#### Specifications

- Pressure rating: - 600 PSI WOG, 150 PSI WOG
- Maximum temperature: - 300°F (149°C)

### Electric Actuator

#### Features

- H-insulation class
- Visual position indication
- Space heater is standard
- NEMA 4/4X waterproof and dustproof

#### Materials

- Gear train: high alloy steel
- Housing: lightweight powder coated aluminum alloy

#### Specification

- Temperature range: -41°F to 140°F (-41°C to 60°C)

#### Approvals

- ISO 9001, CS, CE, and CSA-C US Certified
- RoHS compliant

## 0

A wide variety of options are available: voltages, modulating, extra switches, transmitters, potentiometer, etc. Contact Dixon® Sanitary at 800.789.1718.

Even though there are torque safety factors built into our automated ball valve packages, actual service conditions must also be considered when selecting the proper product for the appropriate application.

For example: Severe service conditions such as dirty water, dirty air, all slurries, raw sewage water, oils, and other viscous fluids can have a dramatic effect in raising the torque requirements of ball valves as much as 75% and therefore larger actuators may be required. Please consult Dixon when dealing with these types of applications.





## Electrically Actuated 3-Way Ball Valves - 'T / L' Port

### 3-Way Stainless Steel

#### 3-Way Stainless Steel Ball Valve

##### Features

- Full port with FNPT ends
- Blow-out proof stem
- Live-loaded stem packing
- ISO 5211 mounting pad

##### Materials

- Body and ball: CF8M stainless steel
- Seats and seals: RTFE

##### Specifications

- Working pressure:
  - 1/4" to 1": **1000 PSI WOG**
  - 1-1/4" to 2": **800 PSI WOG**
- Maximum temperature: **350°F (177°C)**

#### Electric Actuator

##### Features

- NEMA 4/4X waterproof and dustproof
- H-insulation class
- Visual position indication
- Space heater is standard

##### Materials

- Gear train: high alloy steel
- Housing: lightweight powder coated aluminum alloy

##### Specification

- Temperature range: **-41°F to 140°F (-41°C to 60°C)**

##### Approvals

- ISO 9001, CS, CE, and CSA-C US Certified
- RoHS compliant



### 3-Way Brass

#### 3-Way Brass Ball Valve

##### Features

- Reduced port ball valves with FNPT ends
- Blow-out proof stem
- ISO 5211 mounting pad

##### Materials

- Body: brass
- Seats: PTFE with O-ring backing

##### Specifications

- Pressure rating:
  - **400 PSI WOG**
  - **100 PSI WSP**
- Maximum temperature: **300°F (149°C)**

#### Electric Actuator

##### Features

- NEMA 4/4X waterproof and dustproof
- H-insulation class
- Visual position indication
- Space heater is standard

##### Materials

- Gear train: high alloy steel
- Housing: lightweight powder coated aluminum alloy

##### Specification

- Temperature range: **-41°F to 140°F (-41°C to 60°C)**

##### Approvals

- ISO 9001, CS, CE, and CSA-C US Certified
- RoHS compliant



A flow path needs to be selected at time of order. See page 893 for flow path options.

Customer verification is critical. If flow path needs to be changed after being shipped, labor and shipping charges will apply.

A wide variety of options are available: voltages, modulating, extra switches, transmitters, potentiometer, etc. Contact Dixon® Sanitary at 800.789.1718.

Even though there are torque safety factors built into our automated ball valve packages, actual service conditions must also be considered when selecting the proper product for the appropriate application. For example: Severe service conditions such as dirty water, dirty air, all slurries, raw sewage water, oils, and other viscous fluids can have a dramatic effect in raising the torque requirements of ball valves as much as 75% and therefore larger actuators may be required. Please consult Dixon when dealing with these types of applications.



## Pneumatically Actuated Stainless Steel Ball Valves

### 3-Piece Stainless Steel Ball Valve



#### Features

- Blow-out proof stem
- Live-loaded stem packing
- ISO 5211 mounting pad

#### Materials

- Body, ends and ball: CF8M stainless
- Seats: RTFE
- Seals: PTFE

#### Specifications

- Pressure rating:
  - 1/4" - 2" **1000 PSI WOG**
  - 2-1/2" - 3" **800 PSI WOG**
- Temperature range:
  - 1/4" to 2": **-40°F to 350°F (-40°C to 177°C)**
  - 2-1/2" to 3": **-40°F to 325°F (-40°C to 163°C)**

### 2-Piece Rack and Pinion Actuator

#### Features

- NAMUR mounting
- Bi-directional stops for  $\pm 5^\circ$  travel adjustment
- Visual position indication
- Tested to one million cycles
- For spring return actuators must note fail position

#### Materials

- Body: hard anodized aluminum
- Anti-blowout pinion: nickel plated anti-blowout pinion
- O-rings: Nitrile rubber

#### Specifications

- **80 PSI** plant air required
- Maximum operating pressure: **120 PSI**
- Temperature range:
  - **-40°F to 200°F (-40°C to 93°C)**

### 3-Piece

### 3-Piece Stainless Steel Ball Valve



#### Features

- Blow-out proof stem
- Live-loaded stem packing
- ISO 5211 mounting pad
- Swing-out design allows easy maintenance

#### Materials

- Body and ball: CF8M stainless steel
- Stem: 316 stainless steel
- Seat: RTFE

#### Specifications

- Maximum pressure:
  - 1/4" - 2": **1,000 PSI WOG at 65°F**
  - 2-1/2" - 3": **800 PSI WOG at 65°F**
  - 4": **600 PSI WOG at 65°F**
- Temperature range:
  - 1/2" to 2": **-40°F to 350°F (-40°C to 177°C)**
  - 3" to 4": **-40°F to 325°F (-40°C to 163°C)**

### Rack and Pinion Actuator

#### Features

- NAMUR mounting
- Bi-directional stops for  $\pm 5^\circ$  travel adjustment
- Visual position indication
- Tested to one million cycles
- For spring return actuators must note fail position

#### Materials

- Body: hard anodized aluminum
- Anti-blowout pinion: nickel plated
- O-rings: Nitrile rubber

#### Specifications

- **80 PSI** plant air required
- Maximum operating pressure: **120 PSI**
- Temperature range:
  - **-40°F to 200°F (-40°C to 93°C)**

A wide variety of options are available: spring return (normally closed) and double acting actuators, switches, solenoids, positioners, etc. Contact Dixon® Sanitary at 800.789.1718.

Even though there are torque safety factors built into our automated ball valve packages, actual service conditions must also be considered when selecting the proper product for the appropriate application. For example: Severe service conditions such as dirty water, dirty air, all slurries, raw sewage water, oils, and other viscous fluids can have a dramatic effect in raising the torque requirements of ball valves as much as 75% and therefore larger actuators may be required. Please consult Dixon when dealing with these types of applications.



## Pneumatically Actuated Brass Ball Valves

### 2-Piece Brass Ball Valve

#### Features

- Blow-out proof stem
- PTFE seats with double O-ring stem packing
- ISO 5211 mounting pad

#### Materials

- Body: 1/4" to 2" brass, 2-1/2" - 4" bronze
- Seats: PTFE
- Ends: FNPT
- Brass ball
- FKM elastomers

#### Specifications

- Pressure rating: - **600 PSI WOG, 150 PSI WSP**
- Maximum temperature: **300°F (149°C)**

### Rack and Pinion Actuator

#### Features

- NAMUR mounting
- Bi-directional stops for  $\pm 5^\circ$  travel adjustment
- Visual position indication
- Tested to one million cycles
- For spring return actuators must note fail position

#### Materials

- Body: hard anodized aluminum
- Anti-blowout pinion: nickel plated
- O-rings: Nitrile rubber

#### Specifications

- **80 PSI** plant air required
- Maximum operating pressure: **120 PSI**
- Temperature range: **-40°F to 200°F (-40°C to 93°C)**



A wide variety of options are available: spring return (normally closed) and double acting actuators, switches, solenoids, positioners, etc. Contact Dixon® Sanitary at 800.789.1718.

Even though there are torque safety factors built into our automated ball valve packages, actual service conditions must also be considered when selecting the proper product for the appropriate application. For example: Severe service conditions such as dirty water, dirty air, all slurries, raw sewage water, oils, and other viscous fluids can have a dramatic effect in raising the torque requirements of ball valves as much as 75% and therefore larger actuators may be required. Please consult Dixon when dealing with these types of applications.



## Pneumatically Actuated 3-Way Stainless Steel Ball Valves - 'T / L' Port

### 3-Way Stainless Steel Ball Valve

#### Features

- Full port ball valves with FNPT ends
- Blow-out proof stem
- Live-loaded stem packing
- ISO 5211 mounting pad

#### Materials

- Body and ball: CF8M stainless steel
- Seats and seals: RTFE

#### Specifications

- Working pressure:
  - 1/4" to 1": **1000 PSI WOG**
  - 1-1/4" to 2": **800 PSI WSP**
- Maximum temperature: **350°F (177°C)**



### Rack and Pinion Actuator

#### Features

- NAMUR mounting
- Bi-directional stops for  $\pm 5^\circ$  travel adjustment
- Visual position indication
- Tested to one million cycles
- For spring return actuators must note fail position

#### Materials

- Body: hard anodized aluminum
- Anti-blowout pinion: nickel plated
- O-rings: Nitrile rubber

#### Specifications

- **80 PSI** plant air required
- Maximum operating pressure: **120 PSI**
- Temperature range: **-40°F to 200°F (-40° to 93°C)**

A flow path needs to be selected at time of order. See page 893 for flow path options.

Customer verification is critical. If flow path needs to be changed after being shipped, labor and shipping charges will apply.

A wide variety of options are available: spring return (normally closed) and double acting actuators, switches, solenoids, positioners, etc. Contact Dixon® Sanitary at 800.789.1718.

Even though there are torque safety factors built into our automated ball valve packages, actual service conditions must also be considered when selecting the proper product for the appropriate application. For example: Severe service conditions such as dirty water, dirty air, all slurries, raw sewage water, oils, and other viscous fluids can have a dramatic effect in raising the torque requirements of ball valves as much as 75% and therefore larger actuators may be required. Please consult Dixon when dealing with these types of applications.



## Pneumatically Actuated 3-Way Brass Ball Valves - 'T / L' Port

### 3-Way Brass Ball Valve

#### Features

- Reduced port brass ball valves with FNPT ends
- Blow-out proof stem
- PTFE seats with O-ring backing for low operating torque
- ISO 5211 mounting pad

#### Materials

- Body: brass
- Seats: PTFE with O-ring backing
- Ball: chrome-plated brass

#### Specifications

- Pressure rating: **400 PSI WOG, 100 PSI WSP**
- Maximum temperature: **300°F (149°C)**

### Rack and Pinion Actuator

#### Features

- NAMUR mounting
- Bi-directional stops for  $\pm 5^\circ$  travel adjustment
- Visual position indication
- Tested to one million cycles
- For spring return actuators must note fail position

#### Materials

- Body: hard anodized aluminum
- Anti-blowout pinion: nickel plated
- O-rings: Nitrile rubber

#### Specifications

- **80 PSI** plant air required
- Maximum operating pressure: **120 PSI**
- Temperature range: **-40°F to 200°F (-40°C to 93°C)**



A flow path needs to be selected at time of order. See page 893 for flow path options.

Customer verification is critical. If flow path needs to be changed after being shipped, labor and shipping charges will apply.

A wide variety of options are available: spring return (normally closed) and double acting actuators, switches, solenoids, positioners, etc. Contact Dixon® Sanitary at 800.789.1718.

Even though there are torque safety factors built into our automated ball valve packages, actual service conditions must also be considered when selecting the proper product for the appropriate application. For example: Severe service conditions such as dirty water, dirty air, all slurries, raw sewage water, oils, and other viscous fluids can have a dramatic effect in raising the torque requirements of ball valves as much as 75% and therefore larger actuators may be required. Please consult Dixon when dealing with these types of applications.



## Pneumatically Actuated Wafer Butterfly Valves

### Rack and Pinion Actuator

#### Features

- Bi-directional stops for  $\pm 5^\circ$  travel adjustment
- Namur mounting
- Visual position indication
- Tested to 1 million cycles
- For spring return actuators must note fail position

#### Specifications

- **80 PSI** plant air required
- Maximum operating pressure: **120 PSI**
- Temperature range:  
-40°F to 200°F (-40°C to 93°C)

#### Materials

- Body: hard anodized aluminum
- Anti-blowout pinion: nickel plated
- O-rings: Nitrile rubber

### Wafer



#### Features

- Installs between standard ANSI Class 150# flanges
- Seat backing ring ensures blow-out proof service
- A wide variety of seat, disc, and body materials are available
- No taper pins
- Can be serviced in the field

#### Materials

- Body with extended neck: ductile iron
- Disc: nickel plated ductile iron
- Replaceable seat: EPDM

#### Specifications

- Maximum operating pressure: **200 PSI** (bi-directional)
- Temperature range:  
-20°F to 250°F (-29°C to 121°C)

#### Approvals

- Conforms to MSS-SP-67, MSS-SP-25, API-609

### Lug



#### Features

- Installs between standard ANSI Class 150# flanges
- Seat backing ring ensures blow-out proof service
- A wide variety of seat, disc, and body materials are available
- No taper pins
- Can be serviced in the field

#### Materials

- Body with extended neck: ductile iron
- Disc: nickel plated ductile iron
- Replaceable seat: EPDM

#### Specifications

- Maximum operating pressure: **200 PSI** (bi-directional)
- Temperature range:  
-20°F to 250°F (-29°C to 121°C)

#### Approvals

- Conforms to MSS-SP-67, MSS-SP-25, API-609

A wide variety of options are available: spring return (normally closed) and double acting actuators, switches, solenoids, positioners, etc. Contact Dixon® Sanitary at 800.789.1718.

## BV3/4 Series Multi-port Sanitary Stainless Steel Ball Valves

### Flow Paths

3-way 'L'-port  
position A



3-way 'L'-port  
position B



3-way 'L'-port  
position C



3-way 'T'-port  
position A



3-way 'T'-port  
position B



3-way 'T'-port  
position C



3-way 'T'-port  
position D



4-way 'L'-port  
position A



4-way 'L'-port  
position B



4-way 'L'-port  
position C



4-way 'L'-port  
position D



4-way 'T'-port  
position A



4-way 'T'-port  
position B



4-way 'T'-port  
position C



4-way 'T'-port  
position D



## Actuated Valve Accessories



XLS-B4A0120P

### Limit Switches

#### Features

- Visual position indicator
- 3D open/close indication
- Quick-set cam
- Mechanical SPDT switches (standard)
- Multipoint terminal strip
- Various switch options available

#### Enclosures available

##### NEMA 4 4/X

- Water and dust tight for indoor or outdoor use
- Corrosion resistant

##### NEMA 7

- Water and dust tight for indoor or outdoor use
- Corrosion resistant
- For use in indoor hazardous locations
- Explosion proof

#### Specification

- Cable entry: (2) 1/2" NPT

Enclosure	Part #
NEMA 4/4X	XLS-B4A0120P
NEMA 7	XLS-C7A0120P

### Solenoids



#### Features

- Duty cycle: 100% extended duty
- Easy-to-use manual override
- NEMA 4 4/X Enclosure
- Water and dust tight for indoor or outdoor use
- Corrosion resistant
- Voltages available: 12VDC, 24VDC, 24VAC, 48VAC, 110VAC, 220VAC

#### Material

- Electroless nickel plated spool

#### Specifications

- Port sizes: inlet and exhaust 1/4" NPT
- Pressure range: **30 PSI to 150 PSI**

Description	Voltage	Part #
single coil	115VAC	XSO-4S4D-0A
	24VDC	XSO-4S4B-0A
dual coil	115VAC	XSO-4D4D-0A
	24VDC	XSO-4D4B-0A

### Positioners

#### Specifications

- Air capacity:
  - at **29 PSI (200kPa)**: 9.5 SCFM
  - at **87 PSI (600kPa)**: 28.3 SCFM
  - at **145 PSI (1MPa)**: 47.1 SCFM
- Air connections: 1/4" NPT
- Gauges: 1/8" NPT
- Cable entry: 1/2" NPT



#### Electro-Pneumatic

- Input range: 4-20mA (Ri<250ohms)
- Supply pressure: **21.8 to 145 PSI (0.15 to 1MPa)**
- Linearity error: <1.0% f.s
- Hysteresis: <0.6% f.s
- Repeatability: <0.5% f.s

#### Pneumatic

- Input range: **3 to 15 PSI (20-100kPa)**
- Supply pressure: < **145 PSI (<1MPa)**
- Linearity error: <0.7% f.s
- Hysteresis: <0.4% f.s
- Repeatability: <0.3% f.s

Positioner Type	Part #
Electro-Pneumatic	XPO-E4F
Pneumatic	XPO-P4F



## Dixon® MannTek Full Flow Ball Valves

### Features

- Two ports - one inlet and one outlet
- High flow rate; low pressure drop
- Spindle can be disassembled even when ball valve is installed
- Optional ports include DN flange, butt weld, and 150# flange; contact Dixon for details

### Materials

- Wetted parts are aluminum and stainless steel
- FPM seals

### Specifications

- Working pressure: **150 PSI** at ambient temperature **70°F (21°C)**
- Standard valve ports - female NPT, socket weld for Schedule 40 pipe and grooved

#### One-Way Full Flow Ball Valve Female NPT

Size	Aluminum Part #
2"	1WAYBV200
3"	1WAYBV300
4"	1WAYBV400



#### One-Way Full Flow Ball Valve Socket Weld

Size	Bore	Aluminum Part #
2"	2.390"	1WAYBV200SW
3"	3.530"	1WAYBV300SW



#### One-Way Full Flow Ball Valve Grooved

Size	Aluminum Part #
2"	1WAYBV200VIC
3"	1WAYBV300VIC



## Dixon® MannTek Full Flow Ball Valves

### Application

- Commonly used for switching compartments or tanks

### Features

- High flow rate; low pressure drop
- Spindle can be disassembled even when ball valve is installed
- Optional ports include DN flange, butt weld, and 150# flange, contact Dixon for details
- Three ports - one inlet and two outlets, valve directs the flow from the inlet to either of the two outlets

### Materials

- Wetted parts are aluminum and stainless steel
- FPM seals

### Specifications

- Working pressure: **150 PSI** at ambient temperature **70°F (21°C)**
- Standard valve ports - female NPT, socket weld for Schedule 40 pipe and grooved



2WAYBV200-SH

### Two-Way Full Flow Ball Valve Female NPT

Size	Aluminum Part #
2"	2WAYBV200
	2WAYBV200-SH <sup>1</sup>
3"	2WAYBV300
4"	2WAYBV400

<sup>1</sup> Supplied with straight handle



### Two-Way Full Flow Ball Valve Socket Weld

Size	Bore	Aluminum Part #
2"	2.390"	2WAYBV200SW
		2WAYBV200SW-SH <sup>1</sup>
3"	3.530"	2WAYBV300SW

<sup>1</sup> Supplied with straight handle



### Two-Way Full Flow Ball Valve Grooved

Size	Aluminum Part #
2"	2WAYBV200VIC3
3"	2WAYBV300VIC3

## Carbon Steel Ball Valves

### Applications

- For control of air, water, oil, and gas in hose or pipe lines, for other services please contact Dixon

### Materials

- Carbon steel body
- Chromium plated ball
- RPTFE seat and seal

### Features

- Blow-out proof stem
- Adjustable packing gland

### Specification

- Pressure rating: **150 PSI** saturated steam



Female NPT	PSI	Port	Carbon Steel Part #
1/4"	2000	full	IBV25
3/8"	2000		IBV38
1/2"	2000	standard	IBV50
3/4"	2000		IBV75
1"	2000		IBV100
1-1/4"	1500		IBV125
1-1/2"	1500		IBV150
2"	1500		IBV200

## High Pressure Full-Bore 3-Way Ball Valves

**Features**

- Rugged construction
- Black oxide coating

**Materials**

- FKM seals
- POM (polyacetal) ball seats
- Nickel plated ball

**Specification**

- Temperature range: -20°F to 215° F (-29°C to 102°C)

Female NPT	PSI	Carbon Steel Part #
1/2"	5145	HPBV12-3WAY
3/4"		HPBV34-3WAY
1"		HPBV10-3WAY



Standard L 90°

## High Pressure Clear Zinc Ball Valves

**Materials**

- Nitrile rubber O-rings
- POM (Polyacetal) ball seats

**Approval**

- RoHS compliant

Female NPT	PSI	Carbon Steel		PSI
		Part #	SAE Part #	
1/4"	7350	HPBV25ZPL	HPBV25SAEZPL	7350
3/8"		HPBV38ZPL	HPBV38SAEZPL	
1/2"		HPBV12ZPL	HPBV12SAEZPL	
3/4"	6000	HPBV34ZPL	HPBV34SAEZPL	6000
1"		HPBV10ZPL	HPBV10SAEZPL	
1-1/4"		HPBV125ZPL	HPBV125SAEZPL	
1-1/2"		HPBV150ZPL	HPBV150SAEZPL	
2"		HPBV200ZPL	HPBV200SAEZPL	



## High Pressure Full-Bore Ball Valves

**Features**

- Blow-out proof stem
- Rugged construction

**Materials**

- FKM/FPM seals
- POM (Polyacetal) ball seats

Female NPT	PSI	Carbon Steel		PSI	316 Stainless Steel Part #
		Part #	SAE Part #		
1/4"	7350	HPBV25	HPBV25SAE	5880	HPBV25SS
3/8"		HPBV38	HPBV38SAE		HPBV38SS
1/2"		HPBV12	HPBV12SAE		HPBV12SS
3/4"	6000	HPBV34	HPBV34SAE	5145	HPBV34SS
1"		HPBV10	HPBV10SAE		HPBV10SS
1-1/4"		HPBV125	HPBV125SAE	---	---
1-1/2"		HPBV150	HPBV150SAE	---	---
2"		HPBV200	HPBV200SAE	---	---



## 150# Flanged Ball Valves

### Applications

- Suitable for air, water, oil, and gas

### Features

- Four point ISO 5211 mounting pad bolt pattern
- Anti-static grounded ball and stem
- Blow-out proof stem design
- Fire safe (graphite packing and seal)
- Adjustable packing gland

### Materials

- Body: ASTM A216 WCB
- RPTFE seat

### Specifications

- Pressure rating: **150 PSIG** saturated steam
- Temperature up to **400°F (204°C)**
- **PSI** rating up to **280 PSI**
- Bleed/drain port (cast) 1/2" NPT
- Vacuum service to 29 inches of Hg

### Approvals

- Product approvals include: LP gas shut-off valves, flammable liquid shut-off valves, gas shut-off valves, compressed gas shut-off valves, and anhydrous ammonia shut-off valves



Size	Port	Carbon Steel Part #
2"	full	FLBV200CS
2-1/2"		FLBV250CS
3"		FLBV300CS
4"		FLBV400CS
6"		FLBV600CS
8"		FLBV800CS

NOTE: For flange dimensions, diagrams, and additional information please reference [dixonvalve.com](http://dixonvalve.com).

## Polypropylene Bolted Ball Valves

### Feature

- Chemically-resistant, reinforced polypropylene

### Materials

- PTFE ball seat
- EPDM O-ring body seal, FKM O-ring stem seal
- 304 stainless steel nuts and bolts

### Specifications

- Pressure rating:
  - 1/2" - 3" is rated to **125 PSI** at 70°F (21°C)
  - 4" is rated to **90 PSI** at 70°F (21°C)

### Approval

- FDA approved material

### Polypropylene 4-Bolt Ball Valves

Female NPT	Port	Polypropylene Part #
1/2"	full	PVFP50
3/4"		PVFP75
1"		PVFP100
1-1/2"		PVFP150
1"	standard	PV100
2"		PV200

### Polypropylene 6-Bolt Ball Valves

Female NPT	Port	Polypropylene Part #
2"	full	PVFP200
3"		PVFP300

### Polypropylene 8-Bolt Ball Valves

Female NPT	Port	Polypropylene Part #
4"	full	PVFP400



### Polypropylene Compact Bolted Ball Valves

**Materials**

- Chemically-resistant, reinforced polypropylene body, PTFE ball seat
- EPDM O-ring body seal, FKM O-ring stem seals
- 304 stainless steel nuts and bolts

**Specification**

- Pressure rating: 125 PSI at 70°F (21°C)

**Approval**

- FDA approved material

#### Polypropylene Compact Bolted Ball Valve

Female NPT	Port	Body Length	Polypropylene Part #
2"	full	4-7/8"	PVFPS200

#### Polypropylene Compact Bolted Ball Valve

Female NPT x Male Adapter	Port	Body Length	Polypropylene Part #
2"	full	6-7/8"	PVFPSA200



### Polypropylene 45° Single Union Nozzle Valves

**Materials**

- Corrosion resistant polypropylene body, PTFE ball seats
- EPDM O-ring

**Specification**

- Pressure rating: 125 PSI at 70°F (21°C)

**Approval**

- FDA approved material

Female NPT x Nozzle	Port	Polypropylene Part #
1"	full	SUBVN100



### Polypropylene Bolted Ball Valves with Nozzle

**Feature**

- Body-to-flange design allows for low torque operation

**Materials**

- Chemically-resistant, reinforced polypropylene body, PTFE ball seat
- EPDM O-ring body seals, FKM O-ring stem seals
- 304 stainless steel nuts and bolts

**Specification**

- Pressure rating: 125 PSI at 70°F (21°C)

**Approval**

- FDA approved material

Female NPT x Nozzle	Port	Polypropylene Part #
1-1/2"	full	PVFPN150
2"		PVFPN200
2"	standard	PVN200



### Polypropylene Single Union Ball Valves

**Materials**

- Corrosion resistant polypropylene body, PTFE ball seat
- EPDM O-ring

**Specification**

- Pressure rating: 125 PSI at 70°F (21°C)

**Approval**

- FDA approved material

Female NPT	Port	Polypropylene Part #
1/2"	full	SUBV50
3/4"		SUBV75
1"		SUBV100
1-1/4"		SUBV125
1-1/2"		SUBV150
2"		SUBV200
3"		SUBV300



### Domestic Bronze Gate Valves



**Features**

- Class 150
- union bonnet
- ASME B1.20.1
- Grafoil® packing
- Rising stem
- Solid disc

**Specifications**

- Temperature range:  
-20°F to 406°F (-29°C to 208°C)
- Pressure rating:  
**300 PSI** cold working pressure  
**150 PSI** steam working pressure

**Material**

- Malleable iron handwheel

**Approval**

- 100% factory tested

Female NPT	Bronze Part #
1/2"	DBGV50
3/4"	DBGV75
1"	DBGV100
1-1/4"	DBGV125
1-1/2"	DBGV150
2"	DBGV200

### Stainless Steel Gate Valves



brass

**Features**

- Threaded bonnet
- Integral seat
- Adjustable packing nut
- Non-rising stem
- Solid wedge disc

**Material**

- Iron handwheel

**Specification**

- Pressure rating: **200 PSI** non-shock cold water, oil, gas

**Approval**

- 100% factory tested

Female NPT	Brass Part #	316 Stainless Steel Part #
1/4"	BGV25	---
3/8"	BGV38	---
1/2"	BGV50	SSGV50
3/4"	BGV75	SSGV75
1"	BGV100	SSGV100
1-1/4"	BGV125	SSGV125
1-1/2"	BGV150	SSGV150
2"	BGV200	SSGV200
2-1/2"	BGV250	---
3"	BGV300	---
4"	BGV400	---



316 stainless

### Forged Steel Gate Valves

**Application**

- Can be used for steam service



**Features**

- Class 800
- ASTM A105, ANSI B120.1
- Bolted bonnet

**Specifications**

- Pressure rating: **1975 PSI**
- Maximum temperature: **800°F (427°C)**

Female NPT	Forged Steel Part #
1/2"	FSGV50
3/4"	FSGV75
1"	FSGV100
1-1/4"	FSGV125
1-1/2"	FSGV150
2"	FSGV200

### Domestic Bronze Globe Valves

**Features**

- Union bonnet
- ASME B1.20.1
- Grafoil® packing

**Materials**

- PTFE disc
- Malleable iron handwheel

**Specifications**

- Class 150
- Pressure rating:  
**300 PSI** cold working pressure  
**150 PSI** steam working pressure

**Approval**

- 100% factory tested

Female NPT	Bronze Part #
1/2"	DGLBV50
3/4"	DGLBV75
1"	DGLBV100
1-1/4"	DGLBV125
1-1/2"	DGLBV150
2"	DGLBV200



### Forged Steel Globe Valves

**Application**

- Can be used for steam service

**Features**

- ASTM A105, ANSI B120.1
- Bolted bonnet

**Specifications**

- Class 800
- Pressure rating: **1975 PSI**
- Maximum temperature: **800°F (427°C)**

Female NPT	Forged Steel Part #
1/2"	FSGLBV50
3/4"	FSGLBV75
1"	FSGLBV100
1-1/4"	FSGLBV125
1-1/2"	FSGLBV150
2"	FSGLBV200



## Betts Wet-R-Dri™ Butterfly Valves

### Application

- Designed for handling liquid, gaseous, or dry products

### Features

- Has a positive stop in the open and closed position
- Detent spring and ball assist in holding the disc in the open and closed position
- Drilling fits TTMA recommended standards
- Opens by turning hand 1/4 turn counter clockwise

### Specification

- Temperature range: 0°F to 400°F (-17°C to 204°C)

#### Manual

Size	Maximum Working Pressure PSI	Extruded aluminum body with FKM-B disc Part #
2"	75	WD201ALVB
3"		WD301ALVB
4"		WD401ALVB
5"		WD501ALV
6"		WD601ALV
8"		WD801ALV

#### Metering

Size	Maximum Working Pressure PSI	Extruded aluminum body with FKM-B disc Part #
2"	75	WD206ALVB
3"		WD306ALVB
4"		WD406ALVB
5"		WD506ALV
6"		WD606ALV
8"		WD806ALV

#### Replacement Handles

Part #	Description
28967ALEY	replacement handle for 2", 3", 4", and 5" manual handle valves
25933AL	replacement handle for 6" and 8" manual handle valves
28981ALEY	replacement handle for 2", 3', 4", and 5" metering handle valves
26287AL	replacement handle for 6" and 8" metering handle valves

NOTE: For flange dimensions, diagrams and additional information please reference [dixonvalve.com](http://dixonvalve.com).





## Ductile Iron Butterfly Valves

 NOT RECOMMENDED FOR STEAM SERVICE

### Application

- For use between two 150 lb. flanges

### Feature

- 10 position trigger grip handle

### Specification

- Pressure rating: 200 PSI at ambient temperature 70°F (21°C)

### Threaded Lug Style Butterfly Valves

#### Materials

- Ductile iron body, ASTM A536
- Aluminum bronze disc, ASTM B148, ALY.954
- PTFE bushing
- Stainless steel top and bottom stems

Size	Ductile Iron with Nitrile Rubber Liner Part #	Ductile Iron with EPDM Liner Part #
2"	BFVL200	BFVL200E
3"	BFVL300	BFVL300E
4"	BFVL400	BFVL400E
6"	BFVL600	BFVL600E



### Wafer Style 150 lb. Butterfly Valves with Aluminum Bronze Disc

#### Materials

- Ductile iron body, ASTM A536
- Aluminum bronze disc, ASTM B148, ALY.954
- PTFE bushing
- Stainless steel top and bottom stems

Size	Ductile Iron with Nitrile Rubber Liner Part #	Ductile Iron with EPDM Liner Part #
2"	BBFVW200	BBFVW200E
3"	BBFVW300	BBFVW300E
4"	BBFVW400	BBFVW400E
6"	BBFVW600	BBFVW600E



### Wafer Style 150 lb. Butterfly Valves with Stainless Disc

#### Materials

- Ductile iron body, ASTM A536
- Stainless steel disc, ASTM A351, GR. CF-8M
- Nitrile rubber seal and stem seals
- PTFE bushing
- Stainless steel top and bottom stems

Size	Ductile Iron with Nitrile Rubber Liner Part #
2"	BFVW200
3"	BFVW300
4"	BFVW400
6"	BFVW600



### Wafer Style 150 lb. Butterfly Valves with Iron Disc

#### Materials

- Ductile iron body, ASTM A536
- Nickel plated ductile iron disc
- Nitrile rubber seal and stem seals
- PTFE bushing
- 416 stainless stem

Size	Ductile Iron with Nitrile Rubber Liner Part #	Ductile Iron with EPDM Liner Part #
3"	IBFVW300	IBFVW300E
4"	IBFVW400	IBFVW400E
6"	IBFVW600	IBFVW600E
8"	IBFVW800	IBFVW800E



## Flow Control Valves

### Steel Series-F

#### Features

- Two-step needle provides fine adjustments at low flow with the first three turns of the adjusting knob; the next three turns give full-open needle position and conventional throttling control; when flow is reversed, a heavy-duty poppet/retainer permits full-flow return capacity
- Color-coded reference scale simplifies flow setting, resetting, adjusting, and return to original flow; a simple set screw locks the valve on any desired setting



#### Specifications

- Maximum operating pressure:  
**5000 PSI at 70°F (21°C) for 1/8" - 1/2"**  
**3000 PSI at 70°F (21°C) for 3/4" - 2"**

Female NPTF	Black Oxide Steel Part #
1/8"	SFC200
1/4"	SFC400
3/8"	SFC600
1/2"	SFC800
3/4"	SFC1200
1"	SFC1600
1-1/2"	SFC2400
2"	SFC3200

### Brass Series-F

#### Features

- Provides precision flow control and full shutoff in one flow direction; automatically allows unrestricted flow in the opposite direction
- Two-step needle for fine adjustments at low flow with first three turns of the adjusting knob; next three turns give full-open needle position and conventional throttling control
- When flow is reversed, the heavy-duty poppet/retainer permits full flow return capacity
- Color-coded scale simplifies flow setting, resetting, adjusting, and return to an original flow
- A set screw locks the valve on any desired setting



#### Specifications

- Maximum operating pressure:  
**2000 PSI at ambient temperature 70°F (21°C) for sizes 1/8" - 3/4"**  
**500 PSI at ambient temperature 70°F (21°C) for 1"**

Female NPTF	Brass Part #
1/8"	BFC200
1/4"	BFC400
3/8"	BFC600
1/2"	BFC800
3/4"	BFC1200
1"	BFC1600

### Series-MV Metering

#### Features

- Easily make fine adjustments and resets with color code feature that shows when desired setting is reached
- Body components are precision-turned from solid barstock

#### Material

- 416 stainless steel needle

#### Specification

- Maximum operating pressure:  
**5000 PSI at 70°F (21°C)**



Female NPTF	Steel Part #
1/4"	SMV400
3/8"	SMV600
1/2"	SMV800

0

## Flow Control Valves

### Steel Series-N

#### Features

- Excellent speed control on hydraulic systems where a reverse flow check valve is not needed
- Reliable shutoff in a very small envelope; color-coded reference scale simplifies setting, resetting, adjusting, and quick return to a previous speed setting

#### Specifications

- Maximum operating pressure:  
**5000 PSI at 70°F (21°C) for 1/8" - 3/4"**  
**3000 PSI at 70°F (21°C) for 1" - 1-1/4"**

Female NPTF	Steel Part #
1/8"	SN200
1/4"	SN400
3/8"	SN600
1/2"	SN800
3/4"	SN1 200
1"	SN1 600
1-1/4"	SN2000



### Brass Series-N

#### Features

- For use as speed control on hydraulic and pneumatic systems where a reverse flow check valve is not needed
- Provides excellent control and reliable shutoff in a very small envelope
- Color-coded scale simplifies setting, resetting, adjusting, and quick return to a previous speed setting

#### Specifications

- Maximum operating pressure:  
**2000 PSI at 70°F (21°C) for 1/8" - 3/4"**  
**500 PSI at 70°F (21°C) for 1"**

Female NPTF	Brass Part #
1/8"	BN200
1/4"	BN400
3/8"	BN600
1/2"	BN800
3/4"	BN1 200
1"	BN1 600



## Mini Needle Valves

### Features

- Available in a variety of materials and handle options
- FKM O-ring seal and PTFE back-up ring below the threads protects from corrosion and galling
- Stem threads are rolled for strength and ease of operation

### Material

- Stems: 316 stainless steel

### Specifications

- Metal-to-metal hard seat design is 100% helium leak tested to 1 x 10<sup>-4</sup> ml/s at **200 PSI**
- 1/8" and 1/4" are orifice size: 0.172", flow coefficient: 0.42
- 1/2": orifice size are 0.187", flow coefficient: 0.44, hex body

### Male to Female



NPT Size	Handle Style	PSI @ 200°F	Brass Part #	Handle Style	PSI at 200°F	Zinc Nickel Plated Steel Part #	316 Stainless Steel Part #
1/8" - 27	knurled knob	6000	MFB101	T design	10000	MFC101	MFS101
1/4" - 18	knurled knob	6000	MFB102	T design	10000	MFC102	MFS102
1/2" - 14	---	---	---	T design	10000	MFC404	MFS404

### Female to Female

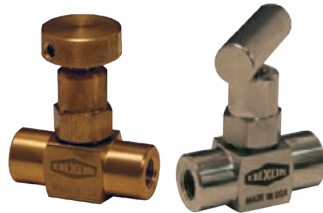

NPT Size	Handle Style	PSI at 200°F	Brass Part #	Handle Style	PSI at 200°F	Zinc Nickel Plated Steel Part #	316 Stainless Steel Part #
1/8" - 27	knurled knob	6000	FFB101	T design	10000	FFC101	FFS101
1/4" - 18	knurled knob	6000	FFB102	T design	10000	FFC102	FFS102
1/2" - 14	---	---	---	T design	10000	FFC404	FFS404

## Multiport Needle Valves

### Features

- Reduces the number of gauge and other instrument connections to permanent piping installations, decreasing possible leak paths
- FKM O-ring seal and PTFE back-up ring below the threads protects from corrosion and galling
- Stem threads are rolled for strength and ease of operation

### Material

- Stems: 316 stainless steel

### Specifications

- Metal-to-metal hard seat design is 100% helium leak tested to 1 x 10<sup>-4</sup> ml/s at **200 PSI**
- 1/2" female NPT port
- Orifice size is 0.187", flow coefficient: 0.44

### Hard Seat Male to Female



NPT Size	Handle Style	PSI at 200°F	Zinc Nickel Plated Steel Part #	316 Stainless Steel Part #
1/2" - 14	T design	10000	MFC204	MFS204
3/4" - 14			MFC20604	MFS20604

### Soft Seat Male to Female



NPT Size	Handle Style	PSI at 200°F	Zinc Nickel Plated Steel Part #	316 Stainless Steel Part #
1/2" - 14	T design	6000	MFC304	MFS304
3/4" - 14			MFC30604	MFS30604

0

## Block and Bleed Needle Valves

### Application

- Allows pressure to be bled off without disturbing the permanent piping installation allowing quick and easy removal or replacement of instruments

### Features

- FKM O-ring seal and PTFE back-up ring below the threads protects from corrosion and galling
- Stem threads are rolled for strength and ease of operation
- 0.090" bleed hole located on bottom is controlled by a 1/4"-20 UNF-2A bleed screw

### Material

- Stems: 316 stainless steel

### Specifications

- Metal-to-metal hard seat design is 100% helium leak tested to 1 x 10<sup>-4</sup> ml/s at **200 PSI**
- Orifice size is 0.187", flow coefficient: 0.44

### Hard Seat Male to Female

NPT Size	Handle Style	PSI at 200°F	Zinc Nickel Plated Steel Part #	316 Stainless Steel Part #
1/4" - 18	T design	10000	MFC602	MFS602
1/2" - 14			MFC604	MFS604

### Soft Seat Male to Female

NPT Size	Handle Style	PSI at 200°F	Zinc Nickel Plated Steel Part #	316 Stainless Steel Part #
1/4" - 18	T design	6000	MFC702	MFS702
1/2" - 14			MFC704	MFS704



## Bleed Needle Valves

### Application

- Convenient way to relieve process pressures trapped between a shut-off valve and the instrument

### Features

- FKM O-ring seal and PTFE back-up ring below the threads protects from corrosion and galling
- Stem threads are rolled for strength and ease of operation
- 0.159" bleed port

### Materials

- Non-rotating soft tip stem and a backup metal-to-metal seal
- Stems: 316 stainless steel

### Specification

- Metal-to-metal hard seat design is 100% helium leak tested to 1 x 10<sup>-4</sup> ml/s at **200 PSI**

### Hard Seat Male

NPT Size	Handle Style	PSI at 200°F	Zinc Nickel Plated Steel Part #	316 Stainless Steel Part #
1/4" - 18	T design	10000	MC802	MS802
1/2" - 14			MC804	MS804

### Soft Tip Male

NPT Size	Handle Style	PSI at 200°F	Zinc Nickel Plated Steel Part #	316 Stainless Steel Part #
1/4" - 18	T design	6000	MC852	MS852
1/2" - 14			MC854	MS854



316 stainless

316 stainless

## Valves

### Button



Thread	Brass Part #
1/4" NPT female	BV2F
1/4" NPT male	BV2M



TFV1S

TFV2

### Tank Filler

#### Applications

- Used on compressed air tanks and other applications

#### Feature

- Standard valve stem thread



TFV1L

TFV2HB

Connection	Length	Nickel Plated Part #	Length	Brass Part #
1/8" NPT	.85"	TFV1S	---	---
	1.24"	TFV1L	---	---
1/4" NPT	1"	TFV2	---	---
1/4" barb	---	---	1.57"	TFV2HB

### Brass Lever External Drains

#### Application

- For air service only

#### Specification

- Maximum operating pressure: 30 PSI at ambient temperature 70°F (21°C)

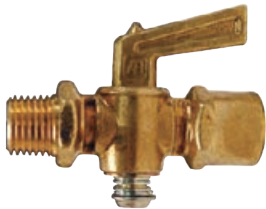

Female NPT	Male NPT	Brass Part #
1/4"	1/4"	LDC2

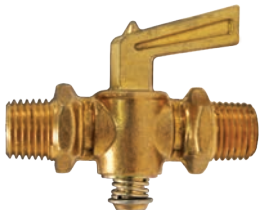

Male NPT	Male NPT	Brass Part #
1/4"	1/4"	LDCM2



Female NPT	Female NPT	Brass Part #
1/4"	1/4"	LDCF2

### Brass External Drain Cocks

#### Application

- Designed for low pressure water and air applications

#### Specification

- Maximum operating pressure: 150 PSI at ambient temperature 70°F (21°C)



NPT Size	Brass Part #
1/8"	D02
1/4"	D04

0

## Needle Valves

### Application

- Designed for air and water applications

### Feature

- Metal-to-metal seats allow positive sealing and flow adjustment

### Specification

- Maximum working pressure: **150 PSI** at ambient temperature 70°F (21°C)

#### Female x Female

Female NPT	Female NPT	Brass Part #
1/8"	1/8"	NV2F
1/4"	1/4"	NV4F

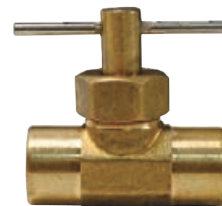

#### Male x Male

Male NPT	Male NPT	Brass Part #
1/4"	1/4"	NV4M

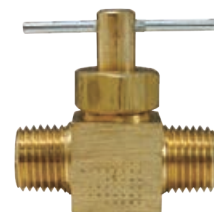

## Safety Check Valves

### Applications

- Used in temporary plant/factory air lines, construction sites, shipyards, or utilities
- Not for use in applications where 100% of the available air is required, i.e. sand blast, pile driving rigs, expansion joint blow down pipes, etc.



### Features

- High-flow valve provides optimum performance
- Controls excess air flow (SCFM) in only one direction
- Automatically senses change in air flow and shuts off the flow in the event of a surge in excess of valve flow rating thus preventing hose whip
- Does not prevent backflow

### Materials

- Solid brass body and valve
- Stainless steel spring and roll pin

### Specifications

- Maximum operating pressure: **350 PSI**
- Maximum temperature: **250°F (121°C)**

### Approval

- Conforms to OSHA regulation 1926.302 (b) (7) requiring a safety device at the source of the air supply and at branch air lines

### How It Works

- Safety check valves utilize the pressure differential across the valve to operate the valve and spring assembly. The pressure differential is directly related to the flow of air (SCFM) through the valve.
- When the pressure differential is within the operating limits - below the cutoff flow - of the unit, the force on the valve exerted by the spring is greater than that caused by the pressure differential (see "Open Position" graphic above). The valve remains open and normal operation continues.
- When the pressure differential is above the cutoff limit, the force on the valve exerted by the pressure differential is greater than the force exerted by the spring, and the valve closes (see the "Closed Position" graphic to the right).
- After the repair is made, normal operation is automatically enabled when pressure across the valve equalizes through the bleeder hole.
- The valve spring size can be specified by determining the air flow during normal operation and by estimating the air flow if a failure or rupture occurs.

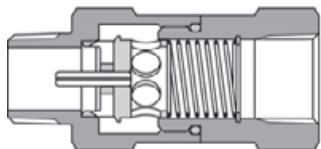
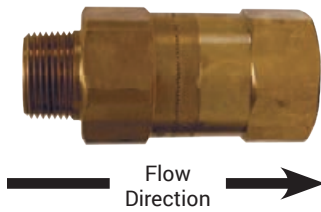

Open Position

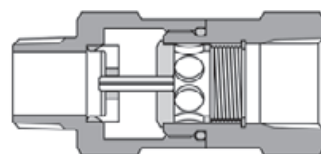

Closed Position

NPT & Hose I.D. Size	Cut-off Flow Rate (SCFM at 90 PSI)	Brass Part #	NPT & Hose I.D. Size	Cut-off Flow Rate (SCFM at 90 PSI)	Brass Part #
1/4"	23-29	SCVL2	1-1/4"	260-290	SCVL10
	30-36	SCVL3		300-340	SCVM10
3/8"	39-47	SCVM3		440-500	SCVS10
	52-65	SCVS3		570-630	SCVH10
1/2"	70-78	SCVM4	1-1/2"	300-360	SCVL12
	80-96	SCVS4		470-530	SCVM12
3/4"	72-88	SCVL6		564-602	SCVX12
	92-108	SCVM6		640-720	SCVS12
	112-128	SCVR6	750-830	SCVH12	
	132-148	SCVJ6	510-590	SCVL16	
1"	160-180	SCVS6	2"	725-825	SCVM16
	180-200	SCVH6		900-1050	SCVS16
	165-195	SCVL8		1100-1200	SCVH16
	220-260	SCVM8		1200-1400	SCVL24
1"	280-320	SCVS8	3"	2400-2700	SCVS24
	310-340	SCVH8		2850-3050	SCVH24



## Safety Pop-Off Valves

### Application

- For use on compressors and in compressed air service

### Feature

- Designed to protect un-fired pressure vessels from over-pressure

### Specification

- Maximum temperature: 400°F (204°C)

### Approvals

- ASME Code, National Board Certified
- CSA B51-03 certified

### Soft Seat

#### Material

- Constructed of precision machined brass bar stock with a silicone disc sealing on the brass

Male NPT	Preset Pressure PSI	SCFM	Brass Part #
1/4"	100	51	KSV10-100
	125	62	KSV10-125
	150	73	KSV10-150
	175	84	KSV10-175



### Standard

#### Materials

- Brass valves are supplied with a stainless steel ball
- Stainless valves are all stainless construction with a soft seat

Male NPT	Preset Pressure PSI	SCFM	Brass Part #	SCFM	Stainless Steel Part #
1/4"	30	35	SV30	35	SV30SS
	100	89	SV100	92	SV100SS
	125	109	SV125	112	SV125SS
	150	129	SV150	132	SV150SS
	175	149	SV175	153	SV175SS
	200	168	SV200	173	SV200SS



### Heavy Duty, High Capacity

#### Material

- All-brass construction with stainless steel ball on a precision machined brass seat

Male NPT	Preset Pressure PSI	SCFM	Brass Part #
1/2"	30	73	SV30HD <sup>1</sup>
	100	208	SV100HD
	125	254	SV125HD
	150	300	SV150HD
	175	346	SV175HD
	200	391	SV200HD



<sup>1</sup> Constructed with soft seat



### Series-C Check Valves



brass



steel

**Feature**

- Provides free flow in one direction and dependable shutoff in the opposite direction

**Specifications**

- Maximum operating pressure: **2000 PSI** at ambient temperature **70°F (21°C)**
- Cracking pressure: **5 PSI**

Female NPT	Free Flow GPM	Maximum Operating PSI at 70°F (21°C)	Brass Part #	Maximum Operating PSI at 70°F (21°C)	Steel Part #
1/8"	3	<b>2000</b>	BCV200	<b>5000</b>	SCV200
1/4"	5	<b>2000</b>	BCV400	<b>5000</b>	SCV400
3/8"	8	<b>2000</b>	BCV600	<b>5000</b>	SCV600
1/2"	15	<b>2000</b>	BCV800	<b>5000</b>	SCV800

### Domestic Ball Cone Check Valves

**Application**

- For use with water, oil, or inert gases. Not recommended for use on or near reciprocating pumps or other similar vibration causing machinery.

**Features**

- Tight shutoff with liquid media
- No radial alignment necessary
- Straight through and streamlined for minimum change in velocity
- Reinforced PTFE check is spring loaded for fast seating action.

**Specifications**

- Pressure rating: **400 PSI WOG**, cold non-shock; **125 PSI** saturated steam
- Cracking pressure: **.5 PSI**
- Temperature range: **-20°F to 353°F (-29°C to 178°C)**

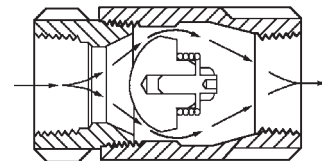

Pressure Ratings

Temperature	Pressure WOG (PSI)
-20°F to 100°F (-29°C to 38°C)	<b>400</b>
200°F (93°C)	<b>200</b>
250°F (121°C)	<b>160</b>
275°F (135°C)	<b>150</b>
300°F (149°C)	<b>140</b>
325°F (163°C)	<b>130</b>
353°F (178°C)	<b>125</b>

#### Ball Cone Check Valve Female NPT x Female NPT

Size	Brass Part #	316 Stainless Steel Part #
1/4"	61-101	62-101
3/8"	61-102	62-102
1/2"	61-103	62-103
3/4"	61-104	62-104
1"	61-105	62-105
1-1/4"	61-106	62-106
1-1/2"	61-107	62-107
2"	61-108	62-108
2-1/2"	61-109	---
3"	61-100	---

#### Ball Cone Check Valve Male NPT x Female NPT

Size	Brass Part #
1/4"	61-201
3/8"	61-202
1/2"	61-203
3/4"	61-204
1"	61-205
1-1/4"	61-206
1-1/2"	61-207
2"	61-208



## 800 PSI Stainless Steel Check Valves

### Features

- Soft PTFE seat is spring loaded for fast seating action
- Flow profile designed to minimize head loss
- Corrosion resistance, excellent for use on chemicals
- Dual guided stem and disc

### Specifications

- Temperature range: **10°F to 450°F (-12°C to 232°C)**
- Pressure rating: **800 PSI WOG; 125 PSI saturated steam**
- Cracking pressure: **.5 PSI**

Female NPT	316 Stainless Steel Part #
1/4"	SSCVIL025
3/8"	SSCVIL038
1/2"	SSCVIL050
3/4"	SSCVIL075
1"	SSCVIL100
1-1/4"	SSCVIL125
1-1/2"	SSCVIL150
2"	SSCVIL200



## Forged Steel Check Valves

### Features

- ASTM A105, ANSI B120.1
- Bolted bonnet
- Can be used for steam service

### Specifications

- Class 800
- Pressure rating: **1975 PSI**
- Maximum temperature: **800°F (427°C)**

Female NPT	Forged Steel Part #
1/2"	FSCV50
3/4"	FSCV75
1"	FSCV100
1-1/4"	FSCV125
1-1/2"	FSCV150
2"	FSCV200



## Spring-Loaded Check Valves

### Features

- Soft seat for bubble tight shutoff, spring loaded for fast seating action
- Flow profile designed to minimize head loss

### Material

- NBR seat

### Specifications

- Pressure rating :1/2" - 2" **400 PSI WOG**; 3" - 4" **175 PSI WOG**
- Temperature range: **10°F to 210°F (-10°C to 100°C)**
- Cracking pressure: **0.50 PSI**

Female NPT	Brass Part #
1/2"	CV050
3/4"	CV075
1"	CV100
1-1/4"	CV125
1-1/2"	CV150
2"	CV200
3"	CV300
4"	CV400

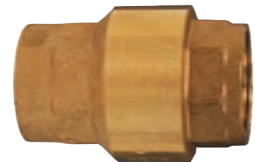

## Strainer with Spring-Loaded Check Valves

### Features

- Soft seat for bubble tight shutoff, spring loaded for fast seating action
- Flow profile designed to minimize head loss

### Material

- Brass with NBR seat and stainless steel strainer

### Specifications

- Temperature range: **10°F to 210°F (-10°C to 100°C)**
- Cracking pressure: **0.50 PSI**
- Pressure rating: 1-1/2" to 2" **400 PSI WOG**, 3"-4" **175 PSI WOG**

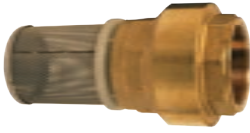

Female NPT	Brass Part #
1-1/2"	BVFS20
2"	BVFS25
3"	BVFS35
4"	BVFS40

## Swing Check Valves

### Applications

- For use in plumbing and liquid piping systems to prevent back flow
- For horizontal or vertical use

### Features

- Full flow performance with a minimum of turbulence or pressure loss
- A positive seating disc allows flow only in one direction and a screw-in cap provides easy access for periodic cleaning.

### Material

- Brass disc

### Specifications

- Pressure rating: **200 PSI WOG**
- Temperature range: **-20° to 150°F (-29°C to 66°C)**



Female NPT	Brass Part #
1/2"	SWCV50
3/4"	SWCV75
1"	SWCV100
1-1/4"	SWCV125
1-1/2"	SWCV150
2"	SWCV200
3"	SWCV300
4"	SWCV400

## Domestic Swing Check Valves

### Features

- Class 150
- ASME B1.20.1
- 100% factory tested

### Specifications

- Working pressure: **300 PSI cold, 150 PSI steam**
- Temperature range: **-20°F to 406°F (-29°C to 208°C)**

### Material

- Metal seat



Female NPT	Brass Part #
1/2"	DSCV50
3/4"	DSCV75
1"	DSCV100
1-1/4"	DSCV125
1-1/2"	DSCV150
2"	DSCV200

### Drum Plug Wrenches

**Features**

- Sparkproof, natural finish is safe around flammables
- Offset handle design reduces user stress and minimizes knuckle injury

Bronze Part #	Aluminum Part #
DPW	ADPW



DPW



ADPW

### Drum Faucets

#### Polyethylene Drum Faucets

**Features**

- No wrench needed for screwing into drum opening
- 2" faucet is shipped with a gasket; the 3/4" does not require a gasket

**Specification**

- Faucets are *not* to be used in applications where temperatures exceed 140°F (60°C).

NPT Thread	Gold Polyethylene Part #
3/4"	PEDF75
2"	PEDF200



#### Stainless Heavy Duty Adjustable Drum Faucets

**Feature**

- Adjustable shank is designed to easily adjust to proper drain position after installing in drum

**Specification**

- 3/4" NPT connection

**Approval**

- FM approved for use with oils and non-flammables

**Material**

- PTFE gasket

Stainless Steel Part #
HDSSF75



FM

#### Brass Heavy Duty Adjustable Drum Faucets

**Feature**

- Easy-to-use, self-closing design

**Approval**

- FM approved for use with oils and non-corrosive flammables

**Specification**

- 3/4" NPT connection

Brass Part #
AHDBF75

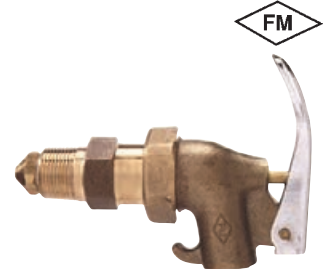

FM

#### Brass Heavy Duty Drum Faucet with Rigid Shanks

**Feature**

- Easy-to-use, self-closing design

**Specification**

- 3/4" NPT connection

**Approval**

- FM approved for use with oils and non-corrosive flammables

**Material**

- PTFE gasket

Brass Part #
HDBF75



FM

### Compression Bibb Faucets

**Application**

- For water use only



**Feature**

- Rough brass finish
- Nozzle end is GHT

Male NPT Inlet	Brass Part #
1/2"	35-201-10
3/4"	35-202-10



### Drum Thread Adapters

**Application**

- For use in gravity discharge from drums



**Features**

- Male NPSH thread with gasket on the drum side allows for a connection to drums with female NPSH thread
- Male NPT end allows for a connection with the female NPT found on most ball valves

Size	Cast Brass Part #
2" x 2"	DMH20DR20

### Drum Gate Valves

**Application**

- Ideal for drawing non-flammable liquids from drums and tanks

**Features**

- Manually operated
- Machined and lapped brass faceplate designed for oval discharge, ensures no splashing and a smooth operation
- Black Japanned finish
- Can be padlocked



Male NPT	Iron Part #
3/4"	D71
2"	D75

**Features**

- Lightweight, durable aluminum body provides improved corrosion resistance for certain fluids
- Sturdy 2" handle is stamped metal with black enamel finish
- Can be padlocked



Male NPT	Aluminum Part #
2"	D75AL

### Self-Closing Gate Valves

**Application**

- Ideal for dispensing viscous liquids such as oil, grease, paint, varnish, and syrups from drums and tanks

**Features**

- Gate closes automatically when handle is released, cleaning discharge surface
- Can be padlocked

**Material**

- Gray iron body, brass sliding gate, and machine lapped sealing surface



Male NPT	Iron Part #
3/4"	D71SC
2"	D75SC

0

**Threaded Pipe Fittings.....919 - 949**

NPT threaded bell reducers ..... 919 - 920

Adapters .....920

NPT threaded couplings .....921

Merchant couplings .....921

NPT threaded unions .....922

Female hex couplings .....922

NPT threaded reducer hex bushings ..... 923 - 924

Reducer hex bushings .....925

Adapters .....925

Pump adapters .....925

Nipples .....926

    Pipe .....926

    Adapters.....926

    Threaded both ends .....927

    Close ..... 927 - 928

    Hex .....928

    Adapters.....929

90° Elbows.....930

    NPT threaded.....930

    Female pipe .....930

    NPT threaded reducing .....931

    Street.....931

    Male Pipe .....931

    NPT threaded street .....932

45° Elbows.....933

Tees..... 934 - 936

    NPT threaded female .....934

    Female .....934

    Threaded side outlet elbows.....935

    Threaded female reducing .....935

    Threaded street service .....935

    Threaded bull head.....935

    Threaded side outlet .....935

    Street.....936

    Male branch.....936

    NPT threaded crosses.....936

    Pipe crosses .....936

Caps .....937

    NPT threaded.....937

    NPTF pipe .....937

Plugs.....938

    NPT threaded square head .....938

    Hex head .....938

    Hex socket .....938

Tuff-Lite® ..... 939 - 942

    Pipe couplings .....939

    Female NPT x female NPT adapters .....939

    Reducer bushings .....939

Threaded swivel nut adapters .....939

Reducing bushings.....939

Close nipples .....940

Hex nipples .....940

Reducer nipples.....940

Nipples .....940

90° elbows .....941

90° Male NPT elbows.....941

90° Street elbows .....941

Tees.....941

Cross .....941

Female threaded swivel nuts.....942

Threaded caps .....942

Hex head drain plugs .....942

Square head drain plugs .....942

Pipe caps .....942

Pipe plugs .....942

Bulkhead fittings .....943

Bulkhead couplings.....943

Bolted fittings .....944

Threaded concentric nipples.....945

Bull plugs .....946

    Bull plugs with tap.....946

Hammer unions..... 947 - 949

**Weld .....950 - 952**

Weld end metal hose fittings.....950

NPT threaded pipe fittings.....951

Dixon® hex nipples .....951

Dixon octagonal nipples.....951

Dixon octagonal wrench grips.....952

Dixon weld-on hex wrench grips.....952

Socket weld butterfly valve flanges .....952

**Tube Fittings .....953 - 997**

Straub restraint pipe couplings.....953

Straub open-flex 1L couplings.....954

Boss ductile flanges .....955

Forged lap joint flanges .....956

Forged slip-on flanges .....956

Forged NPT threaded flanges .....956

Weld neck ASA forged flanges .....957

Flat face flange .....957

King turned back weld-to-metal hose nipples.....957

Quick release couplings.....958

Standard couplings.....959

Lightweight flexible couplings .....960

Rigid couplings.....961



## **Tube Fittings (cont.) .....953 - 997**

Grooved bolted clamps.....	962
Painted iron clamps.....	962
Mechanical tees.....	963
Flange adapters.....	964
Split flanges.....	964
Reducing adapters.....	964
Grooved end fittings.....	965
Caps with tapped outlet.....	966
Blank caps.....	966
Long pipe style nipples.....	966
Grooved end nipples.....	966
Grooved end butterfly valves.....	966
Grooved fitting gaskets.....	967
Grooved fitting accessories.....	968
High density polyethylene couplings.....	969
Y line strainers.....	970
T line strainers.....	970
Gas couplings and adapters.....	971 - 972
Acme spanner wrench.....	972
Gas hose caps and plugs.....	973
Instrumentation fittings.....	974 - 977
Compression fittings.....	978 - 983
Flare fittings.....	984 - 986
Flareless bite fittings.....	987 - 989
Push to connect fittings.....	990 - 991
LIQUIfit™ fittings.....	992 - 995
TrueSeal™ ball valves.....	996 - 997



### NPT Threaded Bell Reducers

**Features**

- Other sizes available
- 304 stainless steel fittings are also available; consult Dixon® for pricing and availability

Female NPT	Female NPT	300# Iron Part #	150# Iron Part #	150# Galvanized Iron Part #
1/4"	1/8"	---	BR1418	---
3/8"	1/8"	---	BR3818	---
	1/4"	---	BR3825	---
1/2"	1/4"	300BR5025	BR5025	BR5025G
	3/8"	---	BR5038	BR5038G
3/4"	1/4"	---	BR7525	---
	3/8"	---	BR7538	---
	1/2"	300BR7550	BR7550	BR7550G
1"	1/4"	---	BR1025	---
	3/8"	---	BR1038	---
	1/2"	---	BR1050	BR1050G
	3/4"	300BR1075	BR1075	BR1075G
1-1/4"	1/2"	---	BR1250	---
	3/4"	---	BR1275	---
	1"	300BR1210	BR1210	BR1210G
1-1/2"	3/4"	---	BR1575	---
	1"	300BR1510	BR1510	BR1510G
	1-1/4"	300BR1512	BR1512	BR1512G
2"	3/4"	---	BR2075	---
	1"	300BR2010	BR2010	BR2010G
	1-1/4"	300BR2012	BR2012	---
	1-1/2"	300BR2015	BR2015	BR2015G
2-1/2"	1"	---	BR2510	---
	1-1/2"	---	BR2515	---
	2"	---	BR2520	BR2520G
3"	1"	---	BR3010	---
	1-1/4"	---	BR3012	---
	1-1/2"	---	BR3015	---
	2"	---	BR3020	BR3020G
	2-1/2"	---	BR3025	BR3025G
4"	1"	---	BR4010	---
	1-1/2"	---	BR4015	---
	2"	---	BR4020	---
	2-1/2"	---	BR4025	---
6"	3"	---	BR4030	BR4030G
	4"	---	BR6030	---
	4"	---	BR6040	---



300# iron



150# iron



150# galvanized iron

NOTE: For additional information on pipe dimensions, please reference [dixonvalve.com](http://dixonvalve.com).



### NPT Threaded Bell Reducers



150# 316 stainless steel



3000# forged steel



125# brass

**Features**

- Other sizes available
- 304 stainless steel fittings are also available; consult Dixon® for pricing and availability

Female NPT	Female NPT	150# 316 Stain.Steel Part #	3000# Forged Steel Part #	125# Brass Part #
1/4"	1/8"	---	---	---
3/8"	1/8"	---	---	---
	1/4"	BR3825SS	---	---
1/2"	1/4"	BR5025SS	---	---
	3/8"	BR5038SS	BR5038FS	BR5038B <sup>1</sup>
3/4"	3/8"	BR7538SS	---	---
	1/2"	BR7550SS	BR7550FS	BR7550B <sup>1</sup>
1"	1/2"	BR1050SS	---	BR1050B
	3/4"	BR1075SS	BR1075FS	BR1075B
1-1/4"	1"	BR1210SS	---	BR1210B
	3/4"	---	---	BR1575B
1-1/2"	1"	BR1510SS	BR1510FS	BR1510B
	1-1/4"	BR1512SS	BR1512FS	---
2"	1"	BR2010SS	BR2010FS	BR2010B
	1-1/2"	BR2015SS	BR2015FS	BR2015B
2-1/2"	2"	---	---	BR2520B
3"	2"	BR3020SS	---	BR3020B
4"	3"	---	---	BR4030B

<sup>1</sup> Items will be discontinued as stock is depleted

### Adapters

#### Reducer Couplings

**Feature**

- Ref SAE 130138



Female NPTF	Brass		Optional Qty	Lead-Free Brass <sup>1,2</sup> Part #
	Previous Part #	Part #		
1/4" x 1/8"	RC2F1F	3770402C	50	---
3/8" x 1/8"	RC3F1F	3770602C	50	---
3/8" x 1/4"	RC3F2F	3770604C	50	---
1/2" x 1/4"	RC4F2F	3770804C	25	---
1/2" x 3/8"	RC4F3F	3770806C	10	3770806CLF
3/4" x 3/8"	RC6F3F	3771206C	10	---
3/4" x 1/2"	RC6F4F	3771208C	10	3771208CLF

<sup>1</sup> NSF®/ANSI 61 certified Lead-Free Brass <=0.25% lead, Alloy C2745

<sup>2</sup> Conforms To: Safe Water Drinking Act (SWDA) of Jan. 4, 2014; California AB1953; RoHS Compliant

NOTE: NPTF threads

NOTE: For additional information on pipe dimensions, please reference [dixonvalve.com](http://dixonvalve.com).



### NPT Threaded Couplings

Female NPT	300# Iron Part #	150# Iron Part #	150# Galvanized Iron Part #
1/8"	---	RHC18	RHC18G
1/4"	300RHC25	RHC25	RHC25G
3/8"	300RHC38	RHC38	RHC38G
1/2"	300RHC50	RHC50	RHC50G
3/4"	300RHC75	RHC75	RHC75G
1"	300RHC100	RHC100	RHC100G
1-1/4"	300RHC125	RHC125	RHC125G
1-1/2"	300RHC150	RHC150	RHC150G
2"	300RHC200	RHC200	RHC200G
2-1/2"	---	RHC250	---
3"	---	RHC300	RHC300G
4"	---	RHC400	RHC400G
5"	---	RHC500	---
6"	---	RHC600	---

Female NPT	150# 316 Stain. Steel Part #	3000# Forged Steel Part #	125# Brass Part #
1/4"	RHC25SS	RHC25FS	RHC25B
3/8"	RHC38SS	RHC38FS	RHC38B
1/2"	RHC50SS	RHC50FS	RHC50B
3/4"	RHC75SS	RHC75FS	RHC75B
1"	RHC100SS	RHC100FS	RHC100B
1-1/4"	RHC125SS	RHC125FS	RHC125B
1-1/2"	RHC150SS	RHC150FS	RHC150B
2"	RHC200SS	RHC200FS	RHC200B
3"	RHC300SS	---	---
4"	RHC400SS	---	---



300# iron



150# iron



150# galvanized iron



150# 316 stainless steel



3000# forged steel



125# brass

### Merchant Couplings

**Feature**

- Other sizes are also available, consult Dixon® for pricing

Female NPSM	Black Iron Part #
1/4"	MRCH25
3/8"	MRCH38
1/2"	MRCH50
3/4"	MRCH75
1"	MRCH100
1-1/4"	MRCH125
1-1/2"	MRCH150
2"	MRCH200
3"	MRCH300 <sup>1</sup>

<sup>1</sup> Has female NPT thread

NOTE: For additional information on pipe dimensions, please reference [dixonvalve.com](http://dixonvalve.com).



### NPT Threaded Unions



300# iron



150# iron



150# galvanized iron



150# 316 stainless steel



3000# forged steel



brass

**Features**

- Other sizes are also available
- 304 stainless steel fittings are also available, consult Dixon® for pricing and availability

Female NPT	300# Iron Part #	150# Iron Part #	150# Galvanized Iron Part #
1/8"	---	MIU18	---
1/4"	---	MIU25	---
3/8"	---	MIU38	TUN038G
1/2"	300MIU50	MIU50	TUN050G
3/4"	300MIU75	MIU75	TUN075G
1"	300MIU100	MIU100	TUN100G
1-1/4"	---	MIU125	TUN125G
1-1/2"	300MIU150	MIU150	TUN150G
2"	---	MIU200	TUN200G
2-1/2"	---	MIU250	---
3"	300MIU300	MIU300	---
4"	---	MIU400	---

Female NPT	150# 316 Stainless Steel Part #	3000# Forged Steel Part #	125# Brass Part #
1/4"	TUN025SS	---	TUN2F
3/8"	TUN038SS	---	TUN3F
1/2"	TUN050SS	TUN050FS	TUN4F
3/4"	TUN075SS	TUN075FS	TUN5F
1"	TUN100SS	TUN100FS	TUN6F
1-1/4"	TUN125SS	---	TUN7F
1-1/2"	TUN150SS	TUN150FS	TUN8F
2"	TUN200SS	TUN200FS	TUN9F

### Female Hex Couplings

**Feature**

- Ref SAE 130138



NPTF	Brass		Pkg Qty	Lead-Free Brass <sup>1, 2</sup> Part #
	Previous Part #	Part #		
1/8" x 1/8"	BA1F1F	3710202C	25	3710202CLF
1/4" x 1/4"	BA2F2F	3710404C	25	3710404CLF
3/8" x 3/8"	BA3F3F	3710606C	25	3710606CLF
1/2" x 1/2"	BA4F4F	3710808C	25	3710808CLF
3/4" x 3/4"	BA6F6F	3711212C	10	---

<sup>1</sup> NSF®/ANSI 61 certified Lead-Free Brass <=0.25% lead, Alloy C2745

<sup>2</sup> Conforms To: Safe Water Drinking Act (SWDA) of Jan. 4, 2014; California AB1953; RoHS Compliant

NOTE: NPTF threads

NOTE: For additional information on pipe dimensions, please reference [dixonvalve.com](http://dixonvalve.com).

### NPT Threaded Reducer Hex Bushings

Male NPT	Female NPT	150# Iron Part #	150# Galvanized Iron Part #	150# 316 Stainless Steel Part #
1/4"	1/8"	HB2518	HB2518G	HB2518SS
3/8"	1/8"	HB3818	---	---
	1/4"	HB3825	HB3825G	HB3825SS
1/2"	1/8"	HB5018	---	---
	1/4"	HB5025	HB5025G	HB5025SS
	3/8"	HB5038	HB5038G	HB5038SS
3/4"	1/8"	HB7518	---	---
	1/4"	HB7525	HB7525G	HB7525SS
	3/8"	HB7538	HB7538G	HB7538SS
	1/2"	HB7550	HB7550G	HB7550SS
1"	1/8"	HB1018	---	---
	1/4"	HB1025	HB1025G	HB1025SS
	3/8"	HB1038	HB1038G	HB1038SS
	1/2"	HB1050	HB1050G	HB1050SS
1-1/4"	3/4"	HB1075	HB1075G	HB1075SS
	1/2"	HB1250	---	---
	3/4"	HB1275	---	HB1275SS
1-1/2"	1"	HB1210	HB1210G	HB1210SS
	1/2"	HB1550	---	---
	3/4"	HB1575	HB1575G	HB1575SS
2"	1"	HB1510	HB1510G	HB1510SS
	1-1/4"	HB1512	HB1512G	HB1512SS
	1/2"	HB2050	HB2050G	---
	3/4"	HB2075	HB2075G	HB2075SS
	1"	HB2010	HB2010G	HB2010SS
2-1/2"	1-1/4"	HB2012	HB2012G	HB2012SS
	1-1/2"	HB2015	HB2015G	HB2015SS
	1-1/2"	HB2515	---	---
3"	2"	HB2520	HB2520G	HB2520SS
	1"	HB3010	---	---
	1-1/2"	HB3015	---	---
	2"	HB3020	HB3020G	HB3020SS
4"	2-1/2"	HB3025	---	HB3025SS
	1"	HB4010	---	---
	1-1/2"	HB4015	---	---
	2"	HB4020	HB4020G	HB4020SS
	2-1/2"	HB4025	---	---
5"	3"	HB4030	HB4030G	HB4030SS
	4"	HB5040	---	---
6"	3"	HB6030	---	---
	4"	HB6040	---	---



150# iron



150# galvanized iron



150# 316 stainless steel

NOTE: For additional information on pipe dimensions please reference [dixonvalve.com](http://dixonvalve.com).



**NPT Threaded Reducer Hex Bushings**



3000# forged steel



125# brass

Male NPT	Female NPT	3000# Forged Steel Part #	125# Brass Part #
1/4"	1/8"	HB2518FS	---
3/8"	1/8"	---	---
	1/4"	HB3825FS	---
1/2"	1/8"	---	---
	1/4"	HB5025FS	---
	3/8"	HB5038FS	---
3/4"	1/8"	---	---
	1/4"	HB7525FS	---
	3/8"	HB7538FS	---
1"	1/2"	HB7550FS	---
	1/4"	HB1025FS	---
	3/8"	HB1038FS	---
1-1/4"	1/2"	HB1050FS	---
	3/4"	HB1075FS	---
	3/4"	HB1275FS	---
1-1/2"	1"	HB1210FS	HB1210B
	3/4"	HB1575FS	HB1575B
	1"	HB1510FS	HB1510B
2"	1-1/4"	HB1512FS	HB1512B
	1/2"	---	HB2050B
	3/4"	HB2075FS	HB2075B
	1"	HB2010FS	HB2010B
	1-1/4"	HB2012FS	HB2012B
2-1/2"	1-1/2"	HB2015FS	HB2015B
	1-1/2"	---	HB2515B
	2"	HB2520FS	HB2520B
3"	2"	HB3020FS	HB3020B
	2-1/2"	HB3025FS	HB3025B
4"	2"	---	HB4020B
	3"	HB4030FS	HB4030B

### Reducer Hex Bushings

**Feature**

- Ref SAE 130140

Male NPTF	Female NPTF	Brass		Optional Qty	Lead-Free Brass <sup>2,3</sup> Part #
		Previous Part #	Part #		
1/4"	1/8"	HB1F2M	3730402C	100	3730402CLF
3/8"	1/8"	HB1F3M	3730602C	100	---
	1/4"	HB2F3M	3730604C	100	3730604CLF
1/2"	1/8"	HB1F4M	3730802C	25	---
	1/4"	HB2F4M	3730804C	50	3730804CLF
	3/8"	HB3F4M	3730806C	50	3730806CLF
3/4"	1/8"	HB1F6M	3731202C <sup>1</sup>	25	---
	1/4"	HB2F6M	3731204C	25	---
	3/8"	HB3F6M	3731206C	25	---
	1/2"	HB4F6M	3731208C	25	3731208CLF
1"	1/4"	HB2F8M	3731604C <sup>1</sup>	10	---
	3/8"	HB3F8M	3731606C <sup>1</sup>	10	---
	1/2"	HB4F8M	3731608C	10	---
	3/4"	HB6F8M	3731612C	10	---



<sup>1</sup> SAE does not provide a standard for these sizes  
<sup>2</sup> NSF®/ANSI 61 certified lead-free brass <=0.25% lead, Alloy C2745  
<sup>3</sup> Conforms To: Safe Water Drinking Act (SWDA) of Jan. 4, 2014; California AB1953; RoHS Compliant  
 NOTE: NPTF threads

### Adapters Female NPTF x Male NPTF

**Feature**

- Ref SAE 130139

Female NPTF	Male NPTF	Brass		Optional Qty	Lead-Free Brass <sup>1,2</sup> Part #
		Previous Part #	Part #		
1/8"	1/8"	RA1F1M	3750202C	100	---
1/4"	1/8"	RA2F1M	3750402C	50	3750402CLF
	1/4"	RA2F2M	3750404C	50	3750404CLF
3/8"	1/8"	RA3F1M	3750602C	50	---
	1/4"	RA3F2M	3750604C	50	3750604CLF
	3/8"	RA3F3M	3750606C	50	---
1/2"	1/4"	RA4F2M	3750804C	25	---
	3/8"	RA4F3M	3750806C	25	---
	1/2"	RA4F4M	3750808C	25	3750808CLF
3/4"	3/8"	RA6F3M	3751206C	10	---
	1/2"	RA6F4M	3751208C	10	---
	3/4"	RA6F6M	3751212C	10	3751212CLF



<sup>1</sup> NSF®/ANSI 61 certified Lead-Free Brass <=0.25% lead, Alloy C2745  
<sup>2</sup> Conforms To: Safe Water Drinking Act (SWDA) of Jan. 4, 2014; California AB1953; RoHS Compliant  
 NOTE: NPTF threads

### Pump Adapters

**Application**

- Used to convert BSP pump outlets to NPT

**Feature**

- Other sizes, configurations are available; contact Dixon®

**Material**

- Hard-coated, extruded 6061-T6 aircraft aluminum alloy

Female BSP	Male NPT	Aluminum Part #
1-1/2"	1-1/2"	AHA15BSP15T
2"	2"	AHA20BSP20T
2-1/2"	2-1/2"	AHA25BSP25T
3"	3"	AHA30BSP30T
4"	4"	AHA40BSP40T



NOTE: For additional information on pipe dimensions, please reference [dixonvalve.com](http://dixonvalve.com).

## Pipe Nipples

### Long Pipe Nipples

**Feature**

- Carbon steel and stainless steel nipples are available on page 927



NPT	Length	Brass		Optional Qty	Lead-Free Brass <sup>1,2</sup> Part #
		Previous Part #	Part #		
1/8"	1-1/2"	166-0215	1660215C	25	---
	2"	166-0220	1660220C	25	---
	2-1/2"	166-0225	1660225C	25	---
	3"	166-0230	1660230C	25	---
	3-1/2"	166-0235	1660235C	10	---
	4"	166-0240	1660240C	10	---
1/4"	1-1/2"	166-0415	1660415C	25	1660415CLF
	2"	166-0420	1660420C	25	---
	2-1/2"	166-0425	1660425C	25	---
	3"	166-0430	1660430C	25	1660430CLF
	3-1/2"	166-0435	1660435C	10	---
	4"	166-0440	1660440C	10	1660440CLF
3/8"	1-1/2"	166-0615	1660615C	25	---
	2"	166-0620	1660620C	25	---
	2-1/2"	166-0625	1660625C	10	---
	3"	166-0630	1660630C	10	---
	3-1/2"	166-0635	1660635C	10	---
	4"	166-0640	1660640C	5	---
1/2"	1-1/2"	166-0815	1660815C	10	---
	2"	166-0820	1660820C	10	---
	2-1/2"	166-0825	1660825C	10	---
	3"	166-0830	1660830C	10	---
	3-1/2"	166-0835	1660835C	10	---
	4"	166-0840	1660840C	5	---
3/4"	2"	166-1220	1661220C	5	---
	2-1/2"	166-1225	1661225C	5	---
	3"	166-1230	1661230C	5	---
	3-1/2"	166-1235	1661235C	5	---
1"	2"	---	TN100X2B	---	---
	3"	---	TN100X3B	---	---
	4"	---	TN100X4B	---	---
1-1/2"	2"	---	TN150X2B	---	---
	3"	---	TN150X3B	---	---
	3"	---	TN200X3B	---	---
2"	4"	---	TN200X4B	---	---
	4"	---	TN200X4B	---	---
	6"	---	TN200X6B	---	---

<sup>1</sup> Lead-free brass <=0.25% lead; Alloy CA2745; Alloy C46400

<sup>2</sup> Conforms To: Safe Water Drinking Act (SWDA) of Jan. 4, 2014; California AB1953; RoHS Compliant

### Female NPTF x Male NPSM Adapters



Female NPTF	Male NPSM	Brass		Optional Qty
		Previous Part #	Part #	
1/4"	1/4"	174-0404	1740404C	100
3/8"	3/8"	174-0606	1740606C	50
1/2"	1/2"	174-0808	1740808C	50

NOTE: For additional information on pipe dimensions please reference [dixonvalve.com](http://dixonvalve.com).



## Pipe Nipples - Threaded Both Ends

### Features

- Brass nipples are available; see page 926
- Other lengths are also available, consult Dixon® for pricing
- Made from schedule 40 welded pipe

### Specification

- Male NPT x male NPT design

NOTE: Do not use pipe nipples as hose inserts.

Male NPT	Overall Length	Carbon Steel Part #	316 Stainless Steel Part #
1/4"	2"	TN025X2	---
	6"	---	TN025X6SS
3/8"	2"	TN038X2	---
	4"	TN038X4	---
	6"	TN038X6	---
1/2"	2"	TN050X2	TN050X2SS
	3"	TN050X3	TN050X3SS
	4"	TN050X4	TN050X4SS
	6"	TN050X6	TN050X6SS
3/4"	2"	TN075X2	TN075X2SS
	3"	TN075X3	TN075X3SS
	4"	TN075X4	TN075X4SS
	6"	TN075X6	TN075X6SS
1"	2"	TN100X2	TN100X2SS
	3"	TN100X3	TN100X3SS
	4"	TN100X4	TN100X4SS
	6"	TN100X6	TN100X6SS
1-1/4"	2"	TN125X2	TN125X2SS
	3"	TN125X3	TN125X3SS
	4"	TN125X4	TN125X4SS
	6"	TN125X6	TN125X6SS
1-1/2"	2"	TN150X2	TN150X2SS
	3"	TN150X3	TN150X3SS
	4"	TN150X4	TN150X4SS
	6"	TN150X6	TN150X6SS
2"	3"	TN200X3	TN200X3SS
	4"	TN200X4	TN200X4SS
	5"	TN200X5	TN200X5SS
	6"	TN200X6	TN200X6SS
3"	8"	TN200X8	---
	3"	TN300X3	TN300X3SS
	4"	TN300X4	TN300X4SS
	6"	TN300X6	TN300X6SS
4"	4"	TN400X4	TN400X4SS
	6"	TN400X6	TN400X6SS
	8"	TN400X8	---
6"	6"	TN600X6	---
	8"	TN600X8	---



carbon steel



stainless steel

## Close Pipe Nipples

NPT	Brass		Optional Qty	Lead-Free Brass <sup>1,2</sup> Part #
	Previous Part #	Part #		
1/8"	165-0202	1650202C	50	1650202CLF
1/4"	165-0404	1650404C	50	1650404CLF
3/8"	165-0606	1650606C	100	1650606CLF
1/2"	165-0808	1650808C	25	1650808CLF
3/4"	165-1212	1651212C	25	1651212CLF
1"	165-1616	1651616C	25	---
1-1/2"	---	CN150B	5	---
2"	---	CN200B	5	---
3"	---	CN300B	5	---



<sup>1</sup> Lead-free brass <=0.25% lead; Alloy CA2745; Alloy C46400

<sup>2</sup> Conforms To: Safe Water Drinking Act (SWDA) of Jan. 4, 2014; California AB1953; RoHS Compliant

NOTE: For additional information on pipe dimensions please reference [dixonvalve.com](http://dixonvalve.com).

### Close Nipples

**Feature**

- Made from schedule 40 welded pipe

**Specification**

- Male NPT x male NPT design



Male NPT	Overall Length	Carbon Steel Part #	Galvanized Part #	316 Stainless Steel Part #	Optional Qty
1/8"	3/4"	---	---	CN012SS	1
1/4"	7/8"	CN025	CN025G	CN025SS	25
3/8"	1"	CN037	---	CN037SS	25
1/2"	1-1/8"	CN050	CN050G	CN050SS	10
3/4"	1-3/8"	CN075	CN075G	CN075SS	10
1"	1-1/2"	CN100	CN100G	CN100SS	10
1-1/4"	1-5/8"	CN125	---	---	10
1-1/2"	1-1/2"	CN150	CN150G	CN150SS	10
2"	2"	CN200	CN200G	CN200SS	10
2-1/2"	2-1/2"	CN250	---	---	--
3"	2-5/8"	CN300	CN300G	CN300SS	1
4"	2-5/8"	CN400	---	CN400SS	5
6"	3-1/8"	CN600	---	---	--

### Hex Nipples

**Feature**

- Ref SAE 130137



NPTF	Brass		Optional Qty	Lead-Free Brass <sup>1,2</sup> Part #
	Previous Part #	Part #		
1/8" x 1/8"	BCN12	3700202C	100	3700202CLF
1/4" x 1/4"	BCN25	3700404C	100	3700404CLF
3/8" x 3/8"	BCN37	3700606C	50	3700606CLF
1/2" x 1/2"	BCN50	3700808C	25	3700808CLF
3/4" x 3/4"	BCN75	3701212C	20	---
1" x 1"	BCN100	3701616C	10	---

<sup>1</sup> NSF®/ANSI 61 certified Lead-Free Brass <=0.25% lead, Alloy C2745

<sup>2</sup> Conforms To: Safe Water Drinking Act (SWDA) of Jan. 4, 2014; California AB1953; RoHS Compliant

NOTE: NPTF threads

### Straight Hex Nipples



Male NPT	316 Stainless Steel Part #
1/4"	HN25SS
3/8"	HN38SS
1/2"	HN50SS
3/4"	HN75SS
1"	HN100SS
1-1/2"	HN150SS
2"	HN200SS

### Reducer Hex Nipples

**Feature**

- Ref SAE 130137



Male NPTF	Brass		Optional Qty
	Previous Part #	Part #	
1/4" x 1/8"	HN2M1M	3790402C	100
3/8" x 1/8"	HN3M1M	3790602C	50
3/8" x 1/4"	HN3M2M	3790604C	50
1/2" x 1/4"	HN4M2M	3790804C	50
1/2" x 3/8"	HN4M3M	3790806C	50
3/4" x 1/2"	HN6M4M	3791208C	25



Male NPT	Male NPT	316 Stainless Steel Part #
3/8"	1/4"	RHN3825SS
1/2"	3/8"	RHN5038SS
3/4"	1/2"	RHN7550SS

NOTE: Do not use pipe nipples as hose inserts.

NOTE: For additional information on pipe dimensions please reference [dixonvalve.com](http://dixonvalve.com).

P

## Adapters

### Ball Seat to Male Pipe

NPSM	NPTF	Brass		Optional Qty
		Previous Part #	Part #	
1/8"	1/8"	BSM11	1720202C	100
1/4"	1/8"	BSM21	1720402C	100
	1/4"	BSM22	1720404C	100
3/8"	1/4"	BSM32	1720604C	100
	3/8"	BSM33	1720606C	50
	1/2"	BSM34	1720608C	50
1/2"	3/8"	BSM43	1720806C	50
	1/2"	BSM44	1720808C	50
3/4"	3/4"	BSM66	1721212C	25



### Male Unions

NPSM	NPSM	Brass		Pkg Qty
		Previous Part #	Part #	
1/8"	1/8"	176-0202	1760202C	100
1/4"	1/4"	176-0404	1760404C	100
3/8"	3/8"	176-0606	1760606C	100
1/2"	1/2"	176-0808	1760808C	50



NOTE: For additional information on pipe dimensions please reference [dixonvalve.com](http://dixonvalve.com).



### NPT Threaded 90° Elbows

**Features**

- Other sizes are also available
- 304 stainless steel fittings are also available, consult Dixon® for pricing and availability



300# iron



150# iron



150# galvanized iron



150# 316 stainless steel



2000# forged steel



125# brass



brass



lead-free brass

Female NPT	300# Iron Part #	150# Iron Part #	150# Galvanized Iron Part #
1/8"	---	EL9018	EL9018G
1/4"	300EL9025	EL9025	EL9025G
3/8"	300EL9038	EL9038	EL9038G
1/2"	300EL9050	EL9050	EL9050G
3/4"	300EL9075	EL9075	EL9075G
1"	300EL90100	EL90100	EL90100G
1-1/4"	300EL90125	EL90125	EL90125G
1-1/2"	300EL90150	EL90150	EL90150G
2"	300EL90200	EL90200	EL90200G
2-1/2"	---	EL90250	---
3"	---	EL90300	EL90300G
4"	---	EL90400	EL90400G
5"	---	EL90500	---
6"	---	EL90600	---

Female NPT	150# 316 Stain. Steel Part #	2000# Forged Steel Part #	125# Brass Part #
1/8"	EL9018SS	---	---
1/4"	EL90025SS	EL9025FS	---
3/8"	EL90038SS	EL9038FS	---
1/2"	EL90050SS	EL9050FS	---
3/4"	EL90075SS	EL9075FS	---
1"	EL90100SS	EL90100FS	EL90100B
1-1/4"	EL90125SS	EL90125FS	---
1-1/2"	EL90150SS	EL90150FS	EL90150B
2"	EL90200SS	EL90200FS	EL90200B
3"	EL90300SS	---	---
4"	EL90400SS	---	---

### 90° Female Pipe Elbows

**Feature**

- Ref SAE 130238

Female NPTF	Extruded Brass		Optional Qty	Forged Lead-Free Brass <sup>1, 2, 3</sup> Part #
	Previous Part #	Part #		
1/8"	EL1F1F	3020202C	25	---
1/4"	EL2F2F	3020404C	25	---
3/8"	EL3F3F	3020606C	25	3020606CLF
1/2"	EL4F4F	3020808C <sup>4</sup>	25	3020808CLF
3/4"	EL6F6F	3021212C <sup>4</sup>	10	---

<sup>1</sup> Lead-free brass <=0.25% lead; Alloy CA2745; Alloy C46400

<sup>2</sup> Conforms To: Safe Water Drinking Act (SWDA) of Jan. 4, 2014; California AB1953; RoHS Compliant

<sup>3</sup> NPT thread

<sup>4</sup> Product shape may vary

NOTE: For additional information on pipe dimensions please reference [dixonvalve.com](http://dixonvalve.com).



## NPT Threaded Reducing Elbows

**Feature**

- Other sizes are also available, consult Dixon® for pricing and availability

Female NPT	Female NPT	150# Iron Part #
1/4"	1/8"	REL2518
1/2"	1/4"	REL5025
1/2"	3/8"	REL5038
3/4"	1/2"	REL7550
1"	1/2"	REL1050
1"	3/4"	REL1075
1-1/4"	1"	REL1210
1-1/2"	1"	REL1510
1-1/2"	1-1/4"	REL1525
2"	1"	REL2010
2"	1-1/2"	REL2015
2-1/2"	2"	REL2520
3"	2"	REL3020
4"	2"	REL4020
4"	3"	REL4030



## 90° Street Elbows

**Feature**

- Ref SAE 130239

Female NPTF	Male NPTF	Extruded Brass		Optional Qty	Forged Lead-Free Brass <sup>1, 2, 3</sup> Part #
		Previous Part #	Part #		
1/8"	1/8"	SE1F1M	3040202C <sup>4</sup>	25	3040202CLF
1/4"	1/8"	SE2F1M	3040402C	25	---
	1/4"	SE2F2M	3040404C <sup>4</sup>	25	3040404CLF
3/8"	1/4"	SE3F2M	3040604C	25	---
	3/8"	SE3F3M	3040606C <sup>4</sup>	25	3040606CLF
1/2"	3/8"	SE4F3M	3040806C	25	---
	1/2"	SE4F4M	3040808C <sup>4</sup>	25	3040808CLF
3/4"	1/2"	SE6F4M	3041208C	25	---
	3/4"	SE6F6M	3041212C <sup>4</sup>	10	---

<sup>1</sup> Lead-free brass <=0.25% lead; Alloy CA2745; Alloy C46400

<sup>2</sup> Conforms To: Safe Water Drinking Act (SWDA) of Jan. 4, 2014; California AB1953; RoHS Compliant

<sup>3</sup> NPT thread

<sup>4</sup> Product shape may vary



brass



lead-free brass

## 90° Male Pipe Elbows

Male NPTF	Forged Brass		Optional Qty
	Previous Part #	Part #	
1/8"	169-0202	1690202C	25
1/4"	169-0404	1690404C	25
3/8"	169-0606	1690606C	25
1/2"	169-0808	1690808C	25



NOTE: For additional information on pipe dimensions please reference [dixonvalve.com](http://dixonvalve.com).



### NPT Threaded 90° Street Elbows



150# iron



150# galvanized iron



150# 316 stainless steel



3000# forged steel



125# brass

**Features**

- Other sizes are also available
- 304 stainless steel fittings are also available, consult Dixon® for pricing and availability

Male NPT	Female NPT	150# Iron Part #	150# Galvanized Iron Part #	150# 316 Stain. Steel Part #
1/8"	1/8"	SE9018	SE9018G	SE9018SS
1/4"	1/4"	SE9025	SE9025G	SE9025SS
3/8"	3/8"	SE9038	SE9038G	SE9038SS
1/2"	1/2"	SE9050	SE9050G	SE9050SS
3/4"	3/4"	SE9075	SE9075G	SE9075SS
1"	1"	SE9010	SE9010G	SE9010SS
1-1/4"	1-1/4"	SE9012	SE9012G	SE9012SS
1-1/2"	1-1/2"	SE9015	SE9015G	SE9015SS
2"	2"	SE9020	SE9020G	SE9020SS
2-1/2"	2-1/2"	SE90250	---	---
3"	3"	SE90300	SE9030G	---
4"	4"	SE90400	---	---
6"	6"	SE90600	---	---

Male NPT	Female NPT	3000# Forged Steel Part #	125# Brass Part #
1/8"	1/8"	---	---
1/4"	1/4"	SE9025FS	---
3/8"	3/8"	SE9038FS	---
1/2"	1/2"	SE9050FS	---
3/4"	3/4"	SE9075FS	SE9075B
1"	1"	SE9010FS	SE9010B
1-1/4"	1-1/4"	SE9012FS	SE9012B
1-1/2"	1-1/2"	SE9015FS	SE9015B
2"	2"	SE9020FS	SE9020B

NOTE: For additional information on pipe dimensions please reference [dixonvalve.com](http://dixonvalve.com).

### NPT Threaded 45° Elbows

Female NPT	150# Iron Part #
1/8"	EL4518
1/4"	EL4525
3/8"	EL4538
1/2"	EL4550
3/4"	EL4575
1"	EL45100
1-1/4"	EL45125
1-1/2"	EL45150
2"	EL45200
2-1/2"	EL45250
3"	EL45300
4"	EL45400
5"	EL45500
6"	EL45600



Size	150# Iron Part #	150# Galvanized Iron Part #
1/8"	SE4518	---
1/4"	SE4525	SE4525G
3/8"	SE4538	---
1/2"	SE4550	SE4550G
3/4"	SE4575	SE4575G
1"	SE45100	---
1-1/4"	SE45125	SE45125G
1-1/2"	SE45150	SE45150G
2"	SE45200	SE45200G
2-1/2"	SE45250	SE45250G
3"	SE45300	SE45300G
4"	SE45400	SE45400G



150# galvanized iron

**Feature**

- Ref SAE 130339

Female NPTF	Male NPTF	Extruded Brass		Optional Qty
		Previous Part #	Part #	
1/8"	1/8"	306-0202	3060202C	25
1/4"	1/4"	306-0404	3060404C	25
3/8"	3/8"	306-0606	3060606C	25
1/2"	1/2"	306-0808	3060808C	25
3/4"	3/4"	306-1212	3061212C	10



NOTE: For additional information on pipe dimensions please reference [dixonvalve.com](http://dixonvalve.com).

### NPT Threaded Female Tees



300# iron



150# iron



150# galvanized iron



150# 316 stainless steel



2000# forged steel



125# brass



brass



lead-free brass

Female NPT	300# Iron Part #	150# Iron Part #	150# Galvanized Iron Part #
1/8"	---	FT18	---
1/4"	300FT25	FT25	FT25G
3/8"	300FT38	FT38	FT38G
1/2"	300FT50	FT50	FT50G
3/4"	---	FT75	FT75G
1"	300FT10	FT10	FT100G
1-1/4"	300FT120	FT120	FT120G
1-1/2"	---	FT15	FT150G
2"	300FT200	FT200	FT200G
2-1/2"	---	FT250	---
3"	---	FT30	FT300G
4"	---	FT40	FT400G
5"	---	FT500	---
6"	---	FT60	---

Female NPT	150# 316 Stainless Steel Part #	2000# Forged Steel Part #	125# Brass Part #
1/8"	---	---	---
1/4"	FT25SS	FT25FS	---
3/8"	FT38SS	---	---
1/2"	FT50SS	FT50FS	---
3/4"	FT75SS	FT75FS	FT75B
1"	FT10SS	FT100FS	FT10B
1-1/4"	FT120SS	FT120FS	---
1-1/2"	FT150SS	FT150FS	FT15B
2"	FT200SS	FT200FS	FT20B

### Female Tees

**Feature**

- Ref SAE 130438

NPTF Thread	Extruded Brass		Optional Qty	Forged Lead-Free Brass <sup>1, 2, 3</sup> Part #
	Previous Part #	Part #		
1/8"	322-0202	3220202C <sup>4</sup>	25	3220202CLF
1/4"	322-0404	3220404C <sup>4</sup>	25	3220404CLF
3/8"	322-0606	3220606C	25	3220606CLF
1/2"	322-0808	3220808C	25	3220808CLF
3/4"	322-1212	3221212C	10	---

<sup>1</sup> Lead-free brass <=0.25% lead; Alloy CA2745; Alloy C46400

<sup>2</sup> Conforms To: Safe Water Drinking Act (SWDA) of Jan. 4, 2014; California AB1953; RoHS Compliant

<sup>3</sup> NPT thread

<sup>4</sup> Product shape may vary

NOTE: For additional information on pipe dimensions please reference dixonvalve.com.





**NPT Threaded Side Outlet Elbows**

Female NPT	150# Iron Part #
1/8"	SOE18
1/4"	SOE25
3/8"	SOE38
1/2"	SOE50
3/4"	SOE75
1"	SOE100
1-1/4"	SOE120
1-1/2"	SOE150
2"	SOE200



**NPT Threaded Female Reducing Tees**

Female NPT	Female NPT	150# Iron Part #
3/8"	1/4"	FRT3825
1/2"	3/8"	FRT5038
3/4"	1/2"	FRT7550
1"	1/2"	FRT1050
1-1/4"	1"	FRT1210
1-1/2"	1"	FRT1510
2"	1"	FRT2010
2"	1-1/2"	FRT2015
3"	2"	FRT3020



**NPT Threaded Street Service Tees**

NPT	150# Iron Part #
1/2"	SST50
3/4"	SST75
1"	SST100
1-1/2"	SST150



**NPT Threaded Bull Head Tees**

Female NPT	Female NPT	150# Iron Part #
1/2"	3/4"	BHT1575
1/2"	1"	BHT1510
3/4"	1"	BHT7510
1"	1-1/2"	BHT1015
1"	2"	BHT1020
1-1/2"	2"	BHT1520
2"	2-1/2"	BHT2025



**NPT Threaded Side Outlet Tees**

Female NPT	150# Iron Part #
1/2"	SOT50
3/4"	SOT75
1"	SOT100
1-1/4"	SOT120
1-1/2"	SOT150
2"	SOT200



NOTE: For additional information on pipe dimensions please reference [dixonvalve.com](http://dixonvalve.com).

### Street Tees

**Feature**

- Ref SAE 130424



Female NPTF	Male NPTF	Extruded Brass		Optional Qty	Lead-Free Brass <sup>1, 2, 3</sup> Part #
		Previous Part #	Part #		
1/8"	1/8"	326-0202	3260202C	25	---
1/4"	1/4"	326-0404	3260404C <sup>4</sup>	25	3260404CLF
3/8"	3/8"	326-0606	3260606C	25	---
1/2"	1/2"	326-0808	3260808C	25	---
3/4"	3/4"	326-1212	3261212C	10	---

<sup>1</sup> Lead-free brass <=0.25% lead; Alloy CA2745; Alloy C46400

<sup>2</sup> Conforms To: Safe Water Drinking Act (SWDA) of Jan. 4, 2014; California AB1953; RoHS Compliant

<sup>3</sup> NPT thread

<sup>4</sup> Product shape may vary

### Male Branch Tees

**Feature**

- Ref SAE 130425



NPTF	Extruded Brass		Optional Qty
	Previous Part #	Part #	
1/8"	324-0202	3240202C	25
1/4"	324-0404	3240404C <sup>1</sup>	25
3/8"	324-0606	3240606C	25
1/2"	324-0808	3240808C	25
3/4"	324-1212	3241212C	10

<sup>1</sup> Product shape may vary

### NPT Threaded Crosses



Female NPT	150# Iron Part #
1/8"	MIC18
1/4"	MIC25
3/8"	MIC38
1/2"	MIC50
3/4"	MIC75
1"	MIC100
1-1/4"	MIC125
1-1/2"	MIC150
2"	MIC200
2-1/2"	MIC250
3"	MIC300
4"	MIC400

### Pipe Crosses



Female NPTF	Extruded Brass		Optional Qty
	Previous Part #	Part #	
1/8"	228-0202	2280202C	25
1/4"	228-0404	2280404C	25
3/8"	228-0606	2280606C	25
1/2"	228-0808	2280808C	10
3/4"	228-1212	2281212C	10

NOTE: For additional information on pipe dimensions please reference [dixonvalve.com](http://dixonvalve.com).

### NPT Threaded Caps

**Features**

- Other sizes are also available
- 304 stainless steel fittings are also available, consult Dixon® for pricing and availability

Female NPT	300# Iron Part #	150# Iron Part #
1/8"	---	MICAP18
1/4"	---	MICAP25
3/8"	---	MICAP38
1/2"	300MICAP50	MICAP50
3/4"	300MICAP75	MICAP75
1"	300MICAP100	MICAP100
1-1/4"	300MICAP125	MICAP120
1-1/2"	300MICAP150	MICAP150
2"	300MICAP200	MICAP200
2-1/2"	---	MICAP250
3"	---	MICAP300
4"	---	MICAP400
5"	---	MICAP500
6"	---	MICAP600



300# iron



150# iron



150# galvanized iron



150# 316 stainless steel

Female NPT	150# Galvanized Iron Part #	150# 316 Stainless Steel Part #
1/8"	---	SSCAP18
1/4"	---	SSCAP25
3/8"	---	SSCAP38
1/2"	MICAP50G	SSCAP50
3/4"	MICAP75G	SSCAP75
1"	---	SSCAP10
1-1/4"	---	SSCAP12
1-1/2"	---	SSCAP15
2"	MICAP200G	SSCAP20

### NPTF Pipe Caps

**Feature**

- Lead-free per NSF/ANSI 372

Female NPTF	Optional Qty	Lead-Free Brass <sup>1,2</sup> Part #
1/8"	50	2130200CLF
1/4"	100	2130400CLF
3/8"	25	2130600CLF
1/2"	25	2130800CLF
3/4"	25	2131200CLF



<sup>1</sup> Lead-free Brass <=.25% lead, Alloy C2745

<sup>2</sup> Conforms To: Safe Water Drinking Act (SWDA) of Jan. 4, 2014; California AB1953; RoHS Compliant

NOTE: For additional information on pipe dimensions please reference [dixonvalve.com](http://dixonvalve.com).

### NPT Threaded Square Head Plugs

**Feature**

- Forged steel and brass plugs are solid; all others are cored



150# iron



150# galvanized iron



150# 316 stainless steel



3000# forged steel



125# brass

Male NPT	150# Iron Part #	150# Galvanized Iron Part #	150# 316 Stain. Steel Part #
1/8"	SHP18	SHP18G	SHP18SS
1/4"	SHP14	SHP14G	SHP14SS
3/8"	SHP38	SHP38G	SHP38SS
1/2"	SHP50	SHP50G	SHP50SS
3/4"	SHP75	SHP75G	SHP75SS
1"	SHP100	SHP100G	SHP100SS
1-1/4"	SHP125	SHP125G	SHP125SS
1-1/2"	SHP150	SHP150G	SHP150SS
2"	SHP200	SHP200G	SHP200SS
2-1/2"	SHP250	SHP250G	SHP250SS
3"	SHP300	SHP300G	SHP300SS
4"	SHP400	SHP400G	SHP400SS
5"	SHP500	---	---
6"	SHP600	SHP600G	---

Male NPT	3000# Forged Steel Part #	125# Brass Part #
1/8"	---	2110200C <sup>1,2</sup>
1/4"	SHP14FS	2110400C <sup>1,2</sup>
3/8"	SHP38FS	2110600C <sup>1,2</sup>
1/2"	SHP50FS	2110800C <sup>1,2</sup>
3/4"	SHP75FS	2111200C <sup>1,2</sup>
1"	SHP100FS	SHP100B
1-1/2"	SHP150FS	SHP150B
2"	SHP200FS	---
3"	SHP300FS	---

<sup>1</sup> Lead-free brass per NSF/ANSI 372, Brass Alloy 260/270

<sup>2</sup> Threads are PTF-SAE

### Hex Head Plugs

NPT	Brass		Pkg Qty	Lead-Free Brass <sup>1,2</sup> Part #
	Previous Part #	Part #		
1/8"	HHP1M	1630200C	50	1630200CLF
1/4"	HHP2M	1630400C	100	1630400CLF
3/8"	HHP3M	1630600C	25	---
1/2"	HHP4M	1630800C	25	---
3/4"	HHP6M	1631200C	25	---
1"	HHP8M	1631600C	10	---

NOTE: Standard brass hex head plug is hollow; lead-free brass is solid

<sup>1</sup> Lead-free brass <=0.25% lead; Alloy CA2745; Alloy C46400

<sup>2</sup> Conforms To: Safe Water Drinking Act (SWDA) of Jan. 4, 2014; California AB1953; RoHS Compliant

### Hex Socket Plugs

**Approval**

- Lead-Free Brass per NSF/ ANSI 372



NPTF	Lead-Free Brass 260/270		Optional Qty
	Previous Part #	Part #	
1/8"	219-0200	2190200C	50
1/4"	219-0400	2190400C	100
3/8"	219-0600	2190600C	25
1/2"	219-0800	2190800C	25
3/4"	219-1200	2191200C	25

NOTE: For additional information on pipe dimensions please reference dixonvalve.com.



### Polypropylene Schedule 80 - Pipe Couplings

Female NPT	Polypropylene Part #
3/4"	62238
1"	62239
1-1/2"	62241
2"	62194



### Tuff-Lite® - Female NPT x Female NPT Adapters

**Feature**

- Sold in package quantity only

Female NPT	Female NPT	Nylon Part #	Pkg Qty
1/2"	1/2"	TA994	25
3/4"	3/4"	TA996	25



### Polypropylene Schedule 80 - Reducer Bushings

Male NPT	Female NPT	Polypropylene Part #
1/2"	1/4"	62267
3/4"	1/2"	62272
1"	1/2"	62275
	3/4"	62276
1-1/4"	3/4"	62277
	1"	62278
1-1/2"	3/4"	62279
	1"	62280
	1-1/4"	62281
2"	3/4"	62195
	1"	62196
	1-1/4"	62197
	1-1/2"	62198
3"	2"	60330



### Tuff-Lite - Male NPT x Female Threaded Swivel Nut Adapters

**Feature**

- Female shipped with a red vinyl washer (TVW7), replacement washers on page 412

Male NPT	Female Thread	Nylon Part #
1/4"	3/4" GHT	TSA72
3/8"		TSA73
1/4"	3/4" NPS	TSA62
3/8"		TSA63



### Tuff-Lite - Reducing Bushings

Male NPT	Female NPT	Nylon Part #
3/8"	1/4"	THB32
1/2"	1/4"	THB42
1/2"	3/8"	THB43
3/4"	1/2"	THB64
1"	3/4"	THB86



NOTE: For additional information on pipe dimensions please reference [dixonvalve.com](http://dixonvalve.com).

### Tuff-Lite® - Close Nipples



**Feature**

- Sold in package quantity only

Male NPT	Nylon Part #	Pkg Qty
1/4"	TCN202	50
3/8"	TCN303	50
1/2"	TCN404	50
3/4"	TCN606	50

### Polypropylene Schedule 80 - Hex Nipples



Male NPT	Polypropylene Part #
1/2"	62221
3/4"	60554
1"	60555
1-1/4"	60556
1-1/2"	60547
2"	60548
3"	61769

### Polypropylene Schedule 80 - Reducer Nipples



Male NPT	Male NPT	Polypropylene Part #
3/4"	1/2"	62233
1"	3/4"	62234
1-1/4"	1"	62235
1-1/2"	1-1/4"	62236
2"	1-1/2"	60549

### Polypropylene Schedule 80 - Nipples



P

Male NPT	Length	Polypropylene Part #
3/4"	4"	62223
	6"	62224
1"	4"	62225
	6"	62226
2"	4"	62192
	6"	62193

NOTE: For additional information on pipe dimensions please reference [dixonvalve.com](http://dixonvalve.com).

### Polypropylene Schedule 80 - 90° Elbows

Female NPT	Polypropylene Part #
1/2"	62215
3/4"	62216
1"	62217
1-1/2"	62219
2"	62191
3"	62220



### Tuff-Lite® - Street Female NPT x 90° Male NPT Elbows

Female NPT	Male NPT	Nylon Part #
1/4"	1/4"	TSE22
1/2"	1/2"	TSE44
3/4"	3/4"	TSE66



### Polypropylene Schedule 80 - 90° Street Elbows

NPT Thread	Polypropylene Part #
1/2"	62243
3/4"	62244
1"	62245
1-1/4"	62246
1-1/2"	62247
2"	62199
3"	62248



### Polypropylene Schedule 80 - Tees

Female NPT	Polypropylene Part #
1/2"	62209
3/4"	62210
1"	62211
1-1/4"	62212
1-1/2"	62213
2"	62190
3"	62214



### Polypropylene Schedule 80 - Cross

Female NPT	Polypropylene Part #
1"	62263



NOTE: For additional information on pipe dimensions please reference [dixonvalve.com](http://dixonvalve.com).



### Tuff-Lite® - Female Threaded Swivel Nuts

Female Thread	Nylon Part #
3/4" NPSM	TCF6
3/4" GHT	TCF7

### Tuff-Lite - Threaded Caps

**Feature**

- Sold in package quantity only



Female Thread	Nylon Part #	Pkg Qty
1/4" NPT	TTC2	50
3/8" NPT	TTC3	50
1/2" NPT	TTC4	50
3/4" NPT	TTC6	50
3/4" GHT	TTC7	50

### Tuff-Lite - Hex Head Drain Plugs

**Feature**

- Sold in package quantity only



Male NPT	Nylon Part #	Pkg Qty
1/8"	TPX1	50
1/4"	TPX2	50
3/8"	TPX3	50
1/2"	TPX4	50
3/4"	TPX6	50
1"	TPX8	50
1-1/4"	TPX10	25

### Tuff-Lite - Square Head Drain Plugs

**Feature**

- Sold in package quantity only



Male NPT	Nylon Part #	Pkg Qty
1/8"	TPS1	50
1/4"	TPS2	50
3/8"	TPS3	50
1/2"	TPS4	50
3/4"	TPS6	50
1"	TPS8	50
1-1/4"	TPS10	25

### Polypropylene Schedule 80 - Pipe Caps



Female NPT	Polypropylene Part #
3/4"	62250
1"	62251

### Polypropylene Schedule 80 - Pipe Plugs



Male NPT	Polypropylene Part #
3/4"	62256
1"	62257
1-1/4"	62258
1-1/2"	62259
2"	62201

NOTE: For additional information on pipe dimensions please reference [dixonvalve.com](http://dixonvalve.com).



## Bulkhead Fittings

### Application

- For use on most poly storage tanks and many steel and fiberglass tanks

### Features

- Glass reinforced polypropylene provides strength and chemical resistance
- EPDM gaskets are standard
- FKM gaskets are available; contact Dixon® to order

### Female NPT Fittings

Female NPT	Hole Size	Polypropylene Part #
1/2"	1-7/16"	62834
3/4"	1-7/16"	60401
1"	2-1/4"	60427
1-1/4"	2-1/4"	60403
1-1/2"	3"	60124
1-1/2"	2-3/8"	63931 <sup>1</sup>
2"	3"	60405
2"	3"	63481 <sup>2</sup>
2" HD <sup>3</sup>	3-1/4"	63683
3"	4-1/2"	62299 <sup>1</sup>

<sup>1</sup> 1-1/2" and 3" do not contain a washer

<sup>2</sup> Designed for tank wall thickness less than 3/8" - low profile



63931



63481



63683

### Gaskets

Size	EPDM Part #
1/2" - 3/4"	60402
1" - 1-1/4"	60404
1-1/2"	63938
2"	60406
2" HD <sup>1</sup>	60336
3"	60331

<sup>1</sup> Heavy duty



### Bulkhead Couplings

Female NPTF	External Male UNS	Length	Brass Part #
1/8"	5/8"	1.50"	207BH2
1/4"	3/4"	1.50"	207BH4
1/4"	3/4"	.94"	207BH4S
3/8"	1"	1.31"	207BH6
1/2" x 3/8"	1-1/8"	1.50"	207BH8-6
1/2"	1-1/8"	1.50"	207BH8
3/4"	1-5/16"	1.50"	207BH12



NOTE: Washer nut is 12L14 steel



## Bolted Fittings

### Polypropylene Female NPT fittings

**Features**

- Bolts thread into back plate of fitting leaving no welds, or holes as potential points of leakage
- (2) required, EPDM gaskets are standard (sold separately)
- FKM gaskets are available; contact Dixon®



**Material**

- 316 stainless steel bolts

Size	Polypropylene Part #
3/4"	60502
1"	60505
1-1/2"	60513
2"	60516

#### Gaskets

Size	EPDM Part #
3/4" - 1"	60498
1-1/2" - 2"	60497

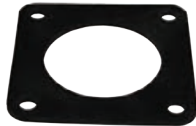

### Stainless Steel Female NPT fittings

**Features**

- Bolts thread into back plate of fitting leaving no welds, or holes as potential points of leakage
- Required, cross-linked polyethylene gaskets are standard (sold separately)
- FKM and EPDM gaskets are available; contact Dixon



**Material**

- 316 stainless steel bolts

Size	Stainless Steel Part #
3/4"	64257
1"	64252
1-1/2"	64253
2"	64202

#### Gaskets

Size	Cross-Linked Polyethylene Part #	EPDM Part #
3/4" - 1"	62950	---
1-1/2"	63042	---
2"	64198	64196

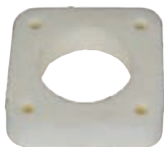

P

## Threaded Concentric Nipples

### Features

- Schedule 40 nipples have blue caps
- Schedule 80 nipples have green caps

### Approvals

- Manufactured in conformance with ASTM A234 and MSS SP-95
- Threads on nipples conform to ASME B1.20.1

Male NPT	Length	Zinc-Plated Schedule 40 Part #
2" x 1"	6.5"	SW40-200100
2" x 1-1/4"		SW40-200125
2" x 1-1/2"		SW40-200150
2-1/2" x 1"	7"	SW40-250100
2-1/2" x 1-1/2"		SW40-250150
2-1/2" x 2"		SW40-250200
3" x 2"	8"	SW40-300200
3" x 2-1/2"		SW40-300250
4" x 2"		SW40-400200
4" x 2-1/2"	9"	SW40-400250
4" x 3"		SW40-400300
6" x 3"		SW40-600300
6" x 4"	12"	SW40-600400
8" x 4"		SW40-800400
8" x 6"		SW40-800600



Male NPT	Length	Zinc-Plated Schedule 80 Part #
1/2" x 1/4"	2.8"	SW80-050025
1/2" x 3/8"		SW80-050038
3/4" x 1/2"	3.0"	SW80-075050
1" x 1/4"	3.5"	SW80-100025
1" x 1/4"		SW80-100050
1" x 3/4"		SW80-100075
2" x 1/2"	6.5"	SW80-200050
2" x 3/4"		SW80-200075
2" x 1"		SW80-200100
2" x 1-1/4"		SW80-200125
2" x 1-1/2"		SW80-200150
2-1/2" x 2"		SW80-250200
3" x 1"	8.0"	SW80-300100
3" x 2"		SW80-300200
3" x 2-1/2"		SW80-300250
4" x 2"	9.0"	SW80-400200
4" x 3"		SW80-400300
4" x 4"		SW80-400400
6" x 3"	12.0"	SW80-600300
6" x 4"		SW80-600400
8" x 6"		SW80-800600



NOTE: For additional information on pipe dimensions please reference [dixonvalve.com](http://dixonvalve.com).

### Bull Plugs



schedule 80

**Features**

- Schedule 40 nipples have blue caps
- Schedule 80 nipples have green caps

**Approvals**

- Manufactured in conformance with ASTM A234 and MSS SP-95
- Threads on nipples conform to ASME B1.20.1

Male NPT	Length	Zinc-Plated Schedule 40 Part #	Zinc-Plated Schedule 80 Part #
2"	4"	BP40-200	BP80-200
2-1/2"	5"	BP40-250	BP80-250
3"	6"	BP40-300	BP80-300
4"	7"	BP40-400	BP80-400

### Bull Plugs with Tap



schedule 40

**Features**

- Schedule 40 nipples have blue caps
- Schedule 80 nipples have green caps

**Approvals**

- Manufactured in conformance with ASTM A234 and MSS SP-95
- Threads on nipples conform to ASME B1.20.1

Male NPT	Length	Zinc-Plated Schedule 40 Part #	Zinc-Plated Schedule 80 Part #
2" x 1/4"	4"	BP40-200T025	BP80-200T025
2" x 1/2"	5"	BP40-200T050	BP80-200T050
3" x 1/2"	6"	BP40-300T050	BP80-300T050
4" x 1/2"	7"	BP40-400T050	BP80-400T050



NOTE: For additional information on pipe dimensions please reference [dixonvalve.com](http://dixonvalve.com).

## Hammer Unions

### Features

- Socket weld configurations and other materials are available; contact Dixon® for further information
- Hammer unions work at extremely high pressures, mismatching components of one series with another (i.e. series 602 with series 1502) can lead to destruction of property, serious bodily injury, or death

### Specifications

- Non-shocking cold water pressure (NSCWP) means that the rated value is the maximum operating pressure at ambient temperature
- No spikes higher than this pressure
- No instantaneous pressure increases (0-2000 PSIG in 1/4 of a second)
- Ambient temperature: **70°F (21°C)**
- Temperature range: **-20°F to 250°F (-29°C to 121°C)**



### 100-Series

#### Feature

- Yellow sub, black nut

#### Specification

- Used on low pressure manifolds and lines and in applications running air, water, oil, or gas up to **1,000 PSI NSCWP**

Size	Configuration	NSCWP (PSI)	Forged Steel Part #
2"	threaded	1000	HU100200
	butt weld	1000	HU100200BW <sup>1</sup>
2-1/2"	threaded	1000	HU100250
3"	threaded	1000	HU100300
4"	threaded	1000	HU100400
	butt weld	1000	HU100400BW <sup>1</sup>
6"	threaded	1000	HU100600
8"	threaded	1000	HU100800

<sup>1</sup> Butt weld ends are schedule 40



### 200-Series

#### Features

- Nitrile O-ring mounted sub provides excellent sealing properties
- Grey sub, blue nut

#### Specification

- Used in general service applications running air, water, oil, or gas up to **2,000 PSI NSCWP**

Size	Configuration	NSCWP (PSI)	Forged Steel Part #
1"	threaded	2000	HU200100
1-1/2"	threaded	2000	HU200150
2"	threaded	2000	HU200200
	butt weld	2000	HU200200BW <sup>1</sup>
2-1/2"	threaded	2000	HU200250
3"	threaded	2000	HU200300
4"	threaded	2000	HU200400
6"	threaded	2000	HU200600
8"	threaded	2000	HU200800

<sup>1</sup> Butt weld ends are schedule 40



### 206-Series

#### Features

- Nitrile O-ring mounted sub provides excellent sealing properties
- Grey sub, blue nut

#### Specification

- Used in general service applications running air, water, oil, and gas up to **2,000 PSI NSCWP**

Size	Configuration	NSCWP (PSI)	Forged Steel Part #
1"	threaded	2000	HU206100
1-1/2"	threaded	2000	HU206150
2"	threaded	2000	HU206200
2-1/2"	threaded	2000	HU206250
3"	threaded	2000	HU206300
4"	threaded	2000	HU206400
6"	threaded	2000	HU206600
8"	threaded	2000	HU206800



## Hammer Unions

### 400-Series

#### Applications

- Used on manifold and line connections, pump, suction, and mud service

#### Feature

- Red sub, black nut

#### Specification

- Up to **4,000 PSI** NSCWP (non-shock cold working pressure)



Size	Configuration	NSCWP (PSI)	Forged Steel Part #
2"	threaded	4000	HU400200
3"	threaded	4000	HU400300
4"	threaded	4000	HU400400

### 602-Series

#### Applications

- For use in mud, manifold service and truck mounting applications running water, oil or mud service

#### Features

- Lip type seal ring minimizes fluid flow turbulence while creating a pressure seal
- Orange sub, black nut

#### Specification

- Up to **6,000 PSI** NSCWP



Size	Configuration	NSCWP (PSI)	Forged Steel Part #
1"	threaded	6000	HU602100
2"	threaded	6000	HU602200
	buttweld	6000	HU602200BW <sup>1</sup>
3"	threaded	6000	HU602300
	buttweld	6000	HU602300BW <sup>1</sup>
4"	threaded	6000	HU602400
	buttweld	6000	HU602400BW <sup>1</sup>

<sup>1</sup> Buttweld ends are schedule 80

### 1002 Series

#### Applications

- For use in high pressure systems and truck mounting applications running water, oil or mud

#### Features

- Lip type seal ring minimizes fluid flow turbulence while creating a pressure seal
- Blue sub, red nut

#### Specification

- Up to **10,000 PSI** NSCWP



Size	Configuration	NSCWP (PSI)	Forged Steel Part #
1"	threaded	10000	HU1002100
2"	threaded	10000	HU1002200
	buttweld	10000	HU1002200BW <sup>1</sup>
3"	threaded	10000	HU1002300
	buttweld	10000	HU1002300BW <sup>1</sup>
4"	threaded	10000	HU1002400
	buttweld	10000	HU1002400BW <sup>1</sup>

<sup>1</sup> Buttweld ends are schedule XXS

## Hammer Unions

### 1502-Series

#### Applications

- For use in extreme high-pressure applications running water, oil or mud

#### Features

- Lip type seal ring minimizes fluid flow turbulence while creating a pressure seal
- Red sub, blue nut

#### Specification

- Up to **15,000 PSI** NSCWP (non-shock cold working pressure)

Size	Configuration	NSCWP (PSI)	Forged Steel Part #
2"	threaded	<b>15000</b>	HU1502200
	butt weld	<b>15000</b>	HU1502200BW <sup>1</sup>
3"	threaded	<b>15000</b>	HU1502300
	butt weld	<b>15000</b>	HU1502300BW <sup>1</sup>
4"	threaded	<b>15000</b>	HU1502400
	butt weld	<b>15000</b>	HU1502400BW <sup>1</sup>

<sup>1</sup> Butt weld ends are schedule XXS



## Hookie - Hook Hose Lifter

#### Application

- For use with hammer unions on pages 947 - 949

#### Features

- Safe working load is 4 tons, with a proof load test of 8 tons
- Supplied complete with retaining clamp

Size	Forged Steel Part #
3"	HA0900-3
4"	HA0900-4
5"	HA0900-5



## Weld End Metal Hose Fittings

### Straight Female

All fittings have 316 seamless stainless steel tubes

**Specification**

- Pressure rating at 70°F (21°C)

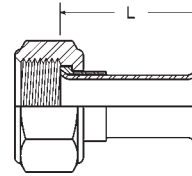
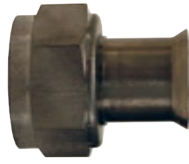

Female SAE 37° JIC	Tube O.D.	Pressure Rating PSI at 70°F (21°)	Dimension L	Tube Wall	304 Stainless Steel Nut & Sleeve Part #	Carbon Steel Nut & Sleeve Part #
7/16" - 20	1/4"	8650	1.500"	.049"	SFMF250	FMF250
9/16" - 18	3/8"	5550	1.500"	.049"	SFMF375	FMF375
3/4" - 16	1/2"	4050	1.500"	.049"	SFMF500	FMF500
1-1/16" - 12	3/4"	2600	1.500"	.049"	SFMF750	FMF750
1-5/16" - 12	1"	1950	2.000"	.049"	SFMF1000	FMF1000
1-5/8" - 12	1-1/4"	2050	2.375"	.065"	SFMF1250	FMF1250
1-7/8" - 12	1-1/2"	1700	2.375"	.065"	SFMF1500	FMF1500
2-1/2" - 12	2"	1250	2.500"	.065"	SFMF2000	FMF2000

### 45° Elbow Female

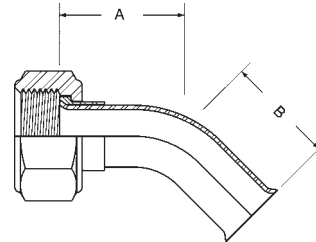

Female SAE 37° JIC	Tube O.D.	Pressure Rating PSI at 70°F (21°)	Dimension		Bend Radius	Tube Wall	304 Stainless Steel Nut & Sleeve Part #	Carbon Steel Nut & Sleeve Part #
			A	B				
7/16" - 20	1/4"	5000	0.750"	0.750"	0.380"	.049"	---	FMF250-45
9/16" - 18	3/8"	4500	1.000"	1.000"	0.500"	.049"	---	FMF375-45
3/4" - 16	1/2"	4000	1.250"	1.250"	1.000"	.049"	SFMF500-45	FMF500-45
1-1/16" - 12	3/4"	2600	1.450"	1.450"	1.500"	.049"	SFMF750-45	---
1-5/16" - 12	1"	2500	1.800"	1.800"	2.000"	.049"	SFMF1000-45	FMF1000-45
1-5/8" - 12	1-1/4"	2050	2.100"	2.100"	2.000"	.065"	---	FMF1250-45
1-7/8" - 12	1-1/2"	1700	2.300"	2.300"	2.000"	.065"	SFMF1500-45	FMF1500-45
2-1/2" - 12	2"	1250	3.000"	3.000"	3.000"	.065"	SFMF2000-45	FMF2000-45

### 90° Elbow Female

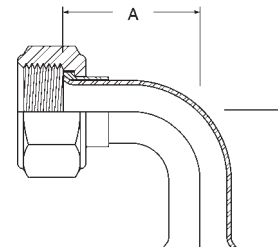

Female SAE 37° JIC	Tube O.D.	Pressure Rating PSI at 70°F (21°)	Dimension		Bend Radius	Tube Wall	304 Stainless Steel Nut & Sleeve Part #	Carbon Steel Nut & Sleeve Part #
			A	B				
7/16" - 20	1/4"	5000	1.000"	1.000"	0.375"	.049"	SFMF250-90	FMF250-90
9/16" - 18	3/8"	4500	1.250"	1.250"	0.500"	.049"	SFMF375-90	FMF375-90
3/4" - 16	1/2"	4000	1.830"	1.830"	1.000"	.049"	SFMF500-90	FMF500-90
1-1/16" - 12	3/4"	2600	2.350"	2.350"	1.500"	.049"	SFMF750-90	FMF750-90
1-5/16" - 12	1"	2500	3.100"	3.100"	2.000"	.049"	SFMF1000-90	FMF1000-90
1-5/8" - 12	1-1/4"	2050	3.500"	3.500"	2.000"	.065"	SFMF1250-90	FMF1250-90
1-7/8" - 12	1-1/2"	1700	3.750"	3.750"	2.000"	.065"	SFMF1500-90	FMF1500-90
2-1/2" - 12	2"	1250	4.900"	4.900"	2.000"	.065"	SFMF2000-90	FMF2000-90

P



### NPT Threaded Pipe Fittings

Size	Overall Length	Carbon Steel Part #	304 Stainless Steel Part #	Aluminum Part #
1/4"	2"	PN250	PNS250	---
3/8"	2"	PN375	PNS375	---
1/2"	2"	PN500	PNS500	---
3/4"	2"	PN750	PNS750	---
1"	2"	PN1000	PNS1000	---
1-1/4"	2"	PN1250	PNS1250	---
1-1/2"	2"	PN1500	PNS1500	---
2"	2"	PN2000	PNS2000	---
2-1/2"	3"	PN2500	PNS2500	---
3"	3"	PN3000	PNS3000	APN3000
4"	4"	PN4000	PNS4000	APN4000



### Dixon® Hex Nipples for Welding to Metal Hose

Size	Carbon Steel <sup>1</sup> Part #	Optional Qty	Machined Brass Part #
1/4"	FM250	200	FMB250
3/8"	FM375	100	FMB375
1/2"	FM500	50	FMB500
3/4"	FM750	50	FMB750
1"	FM1000	50	FMB1000
1-1/4"	FM1250	50	---
1-1/2"	FM1500	50	---
2"	FM2000	10	---



carbon steel

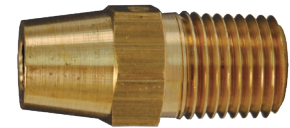

machined brass

Size	304 Stainless Steel <sup>1</sup> Part #	Optional Qty	316 Stainless Steel <sup>1</sup> Part #
1/4"	FMS250	200	---
3/8"	FMS375	100	---
1/2"	FMS500 <sup>2</sup>	50	FMR500 <sup>2</sup>
3/4"	FMS750 <sup>2</sup>	50	FMR750 <sup>2</sup>
1"	FMS1000 <sup>2</sup>	50	FMR1000 <sup>2</sup>
1-1/4"	FMS1250	50	---
1-1/2"	FMS1500	50	FMR1500



global stainless

<sup>1</sup> Dixon suggests using 308 LSI welding rod

<sup>2</sup> Global stainless steel

### Dixon Octagonal Nipples for Welding to Metal Hose

Size	Overall Length	Weld-On Length	Hex Length	Carbon Steel Part #	304 Stainless Steel Part #
2"	2-1/2"	7/8"	9/16"	OCTOE32	OCTOES32



NOTE: For additional information on pipe dimensions please reference [dixonvalve.com](http://dixonvalve.com).

### Dixon® Octagonal Wrench Grips



Size	Across Outside Flats	Across Inside Flats	Width	304 Stainless Steel Part #
1-1/2"	2.230"	1.910"	9/16"	OCTS24
2"	2.781"	2.385"	9/16"	OCTS32
3"	3.750"	3.510"	7/8"	OCTS48

Size	Across Outside Flats	Across Inside Flats	Width	Carbon Steel Part #
2"	2.740"	2.510"	9/16"	OCT32

### Dixon Weld-On Hex Wrench Grips



Size	Global Investment Cast Steel Part #
1"	WN12
1-1/4"	WN16
1-1/2"	WN21
2"	WN26
2-1/2"	WN31
3"	WN36
4"	WN46

### Socket Weld Butterfly Valve Flanges



**Application**

- Used in the piping systems within hydraulic fracturing operations for the transfer of fluids and slurries

**Feature**

- Slip-on butterfly flanges for welding on to 4", 5", and 8" pipe

Size	# of Bolt Holes	Carbon Steel Part #
4"	6	HSW400
5"	6	HSW500
8"	8	HSW800



## Straub Grip-L Axial Restraint Pipe Couplings

### Applications

- Suitable for pipes within the lower pressure range. Applications include, but are not limited to: ship building, water and waste water treatment plants, and industrial process pipe work

### Features

- Joins like or dissimilar pipe materials: steel, galvanized, painted, stainless steel, thin-wall stainless steel, PVC, copper
- Requires no special tools or pipe-end preparation; only a torque wrench is required for a secure and safe pipe connection that seldom needs retightening
- Accommodates up to 5° of pipe misalignment
- Vary gap between pipe ends
- Absorbs vibration, water hammer, and sound
- Special patented grip ring for superior holding power on hard-surfaced pipes
- 5-year limited warranty
- Reusable
- NBR and FKM sleeves available; contact Dixon® for information

### Materials

- Casing: AISI 316Ti; screws: AISI 316 L; bolts: AISI 316 Ti; anchoring ring: AISI 301; sealing sleeve: EPDM standard

### Specifications

- EPDM sealing sleeve temperature range: - 4°F to 176°F (-20°C to 80°C)
- American Bureau of Shipping (ABS) up to **232 PSI** on 3/4" - 5"; **188 PSI** on 6"; **145 PSI** on 8"

### Approvals

- Underwriters' Laboratories (UL)
- National Sanitation Foundation (NSF)
- Built to ASTM 1476, Type 2, Class 2 specifications

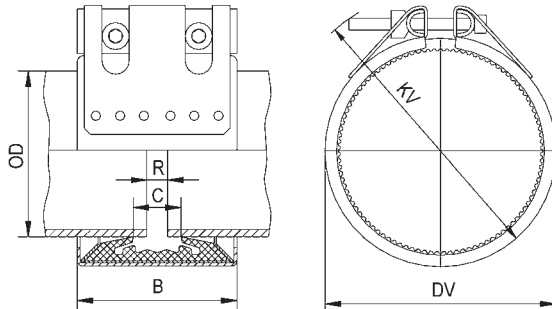

Size	Pipe O.D. Range		Working Pressure PSI	Coupling Dimensions		Assembled Dimensions		Maximum Distance Between Pipe End R	316 Ti Stainless Steel Part #
	actual	min to max		B	C	DV	KV		
3/4"	1.06"	1.04" to 1.08"	670	1.8"	0.7"	1.7"	2.8"	0.2"	STR20000 <sup>1</sup>
1"	1.33"	1.31" to 1.35"	550	1.8"	0.7"	2.0"	3.0"	0.2"	STR20100 <sup>1</sup>
1-1/2"	1.90"	1.88" to 1.92"	440	2.4"	1.0"	2.6"	3.9"	0.2"	STR20300 <sup>1</sup>
2"	2.37"	2.35" to 2.40"	320	3.0"	1.5"	3.1"	4.3"	0.4"	STR20450 <sup>1</sup>
2-1/2"	2.87"	2.85" to 2.90"	450	3.7"	1.6"	3.9"	5.3"	0.4"	STR20500
3"	3.50"	3.46" to 3.54"	320	3.7"	1.6"	4.4"	5.9"	0.4"	STR20650
4"	4.50"	4.46" to 4.54"	232	3.7"	1.6"	5.4"	6.7"	0.4"	STR20900
5"	5.50"	5.51" to 5.62"	232	4.3"	2.1"	6.5"	8.3"	0.4"	STR21150
6"	6.63"	6.56" to 6.69"	232	4.3"	2.1"	7.6"	9.1"	0.4"	STR21350
8"	8.63"	8.54" to 8.71"	232	5.6"	3.1"	9.8"	11.6"	0.4"	STR21400

<sup>1</sup> Only has one bolt

NOTE: All Straub couplings require the correct use of a torque wrench for a safe and proper installation. Straub couplings must be torqued to the specified value as printed on each individual coupling. Failure to do so can result in serious injury or death. Not for steam or refrigerant service.

## Straub Open-Flex 1L Couplings

### Application

- Suitable for repairing or joining pipes where access to the pipe end is difficult or impossible

### Features

- Use to replace bolted sleeve type couplings (AWWA Std. C-219) or for permanent repairs or installation
- Wrap-around design differs from similar type repair products because the installation or repair is permanent due to the unique flexible lip seal gasket design
- Joins like or dissimilar pipe materials: steel, galvanized, painted, stainless steel, thin-wall stainless steel, PVC, copper
- Requires no special tools or pipe-end preparation; only a torque wrench is required for a secure and safe pipe connection that seldom needs retightening
- Accommodates up to 5° of pipe misalignment
- Vary gap between pipe ends
- Absorbs vibration, water hammer, and sound
- Acts as an expansion joint; will accept up to .25" of axial movement
- 5-year limited warranty
- Reusable



### Materials

- Casing: AISI 316Ti; screws: AISI 4135 steel; bolts: AISI 12L 14 galvanized

### Specifications

- EPDM sealing sleeve temperature range: - 4°F to 176°F (-20°C to 80°C)
- American Bureau of Shipping (ABS) up to 232 PSI

### Approvals

- Underwriters' Laboratories (UL)
- National Sanitation Foundation (NSF)
- Conforms to ASTM 1476, Type 2, Class 3 specifications

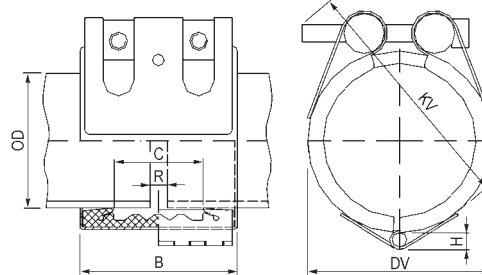

Size	Pipe O.D. Range		Working Pressure PSI	Coupling Dimensions			Assembled Dimensions		Maximum Distance Between Pipe End R	316 Ti Stainless Steel Part #
	actual	min to max		B	C	H	DV	KV		
1-1/2"	1.90"	1.85" to 1.95"	363	3.0"	1.4"	.28"	2.8"	3.3"	.20"	STR35001
2"	2.38"	2.32" to 2.42"	232	3.0"	1.4"	.28"	3.2"	3.7"	.20"	STR35151
2-1/2"	2.88"	2.81" to 2.93"	232	3.0"	1.4"	.36"	3.2"	3.7"	.20"	STR35201
3"	3.50"	3.44" to 3.56"	232	3.7"	2.0"	.36"	4.4"	4.9"	.20"	STR35351
4"	4.50"	4.43" to 4.57"	232	3.7"	2.0"	.36"	5.4"	5.9"	.20"	STR35651
5"	5.56"	5.49" to 5.57"	232	4.2"	2.4"	.38"	6.4"	7.1"	.20"	STR35901
6"	6.63"	6.54" to 6.71"	232	4.2"	2.4"	.38"	7.5"	8.1"	.20"	STR36051

**!** NOTE: Not pull-out resistant. Ensure that pipes are properly anchored and supported.

### Assembly Tool



Part #

STR6648

## Boss Ductile Flanges

## Lap-Joint



## Features

- ANSI B16.5 class 150 lb. bolt circle

## Material

- Ductile iron ASTM A-395 (60-40-18)

Size	I.D.	O.D.	Thickness	Hub at Base	Length Through Hub	Inside Corner Radius	Bolt Hole Diameter	Bolt Circle Diameter	Ductile Iron Part #
1"	1.38	4.25	0.56	1.94	0.69	0.13	0.63	3.12	LJD100
1-1/2"	1.97	5.00	0.69	2.56	0.88	0.25	0.63	3.88	LJD150
2"	2.46	6.00	0.75	3.06	1.00	0.31	0.75	4.75	LJD200
3"	3.60	7.50	0.94	4.25	1.19	0.38	0.75	6.00	LJD300
4"	4.60	9.00	0.94	5.31	1.31	0.44	0.75	7.50	LJD400
6"	6.75	11.00	1.00	7.56	1.56	0.50	0.88	9.50	LJD600
8"	8.75	13.50	1.12	9.69	1.75	0.50	0.88	11.75	LJD800
10"	10.92	16.00	1.19	12.00	1.94	0.50	1.00	14.25	LJD1000
12"	12.92	19.00	1.25	14.38	2.19	0.50	1.00	17.00	LJD1200



## Slip-on Angle Ring

## Feature

- ANSI B16.5 class 150 lb. bolt circle

## Material

- Ductile iron ASTM A-536 (65-45-12)

Size	I.D.	O.D.	Thickness	Bolt Hole Diameter	Bolt Circle Diameter	Ductile Iron Part #
1"	1.75	4.5	0.50	0.63	3.13	BFAR100
1-1/2"	2.25	5.0	0.50	0.63	3.88	BFAR150
2"	2.75	6.0	0.50	0.75	4.75	BFAR200
3"	3.88	7.5	0.50	0.75	6.00	BFAR300
4"	4.93	9.0	0.56	0.75	7.50	BFAR400
6"	7.13	11.0	0.63	0.88	9.50	BFAR600
8"	9.19	13.5	0.63	0.88	11.75	BFAR800
10"	11.31	16.0	0.63	1.00	14.25	BFAR1000
12"	13.38	19.0	0.75	1.00	17.00	BFAR1200
14"	14.88	21.0	0.75	1.13	18.75	BFAR1400
16"	16.88	23.5	0.75	1.13	21.25	BFAR1600
18"	18.88	25.0	0.88	1.25	22.75	BFAR1800



## Back-up Flange for Stub End

## Feature

- ANSI B16.5 class 150 lb. bolt circle

## Material

- Ductile iron ASTM A-536 (65-45-12)

Size	I.D.	O.D.	Thickness	Bolt Hole Diameter	Bolt Circle Diameter	Ductile Iron Part #
1"	1.38	4.3	0.50	0.63	3.13	BFSE100
1-1/2"	1.97	5.0	0.50	0.75	3.88	BFSE150
2"	2.44	6.0	0.50	0.75	4.75	BFSE200
3"	3.56	7.5	0.50	0.75	6.00	BFSE300
4"	4.56	9.0	0.56	0.75	7.50	BFSE400
6"	6.75	11.0	0.63	0.88	9.50	BFSE600
8"	8.75	13.5	0.63	0.88	11.75	BFSE800



### 150 Lb. ASA Forged Lap Joint Flanges

**Features**

- No raised face
- Commonly called a Van Stone or a floating flange



Size	Number of Bolts	Carbon Steel Part #	316 Stainless Steel Part #
1"	4	LJ100	---
1-1/4"		LJ125	---
1-1/2"		LJ150	LJR150
2"		LJ200	LJR200
2-1/2"		LJ250	---
3"	8	LJ300	LJR300
4"		LJ400	LJR400
5"		LJ500	---
6"		LJ600	LJR600
8"		LJ800	---
10"	12	LJ1000	---
12"		LJ1200	---

### 150 Lb. ASA Forged Slip-On Flanges

**Feature**

- Raised face



Size	Number of Bolts	Carbon Steel Part #	316 Stainless Steel Part #
1"	4	SO100	---
1-1/4"		SO125	---
1-1/2"		SO150	SOR150
2"		SO200	SOR200
2-1/2"		SO250	---
3"	8	SO300	SOR300
4"		SO400	SOR400
5"		SO500	---
6"		SO600	SOR600
8"		SO800	---
10"	12	SO1000	---
12"		SO1200	---

### 150 Lb. ASA Forged NPT Threaded Flanges

**Feature**

- Raised face

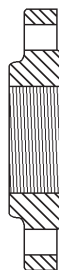

Size	Number of Bolts	Carbon Steel Part #	316 Stainless Steel Part #
1"	4	T100	---
1-1/4"		T125	---
1-1/2"		T150	TR150
2"		T200	TR200
2-1/2"		T250	---
3"	8	T300	TR300
4"		T400	TR400
5"		T500	---
6"		T600	TR600
8"		T800	---
10"	12	T1000	---
12"		T1200	---

NOTE: For flange dimensions, diagrams and additional information please reference [dixonvalve.com](http://dixonvalve.com).

### 150 Lb. Weld Neck ASA Forged Flanges

**Feature**

- Raised face

Size	Number of Bolts	Carbon Steel Part #
1"	4	WN100
1-1/4"		WN125
1-1/2"		WN150
2"		WN200
3"		WN300
4"	8	WN400
5"		WN500
6"		WN600
8"		WN800
10"		12

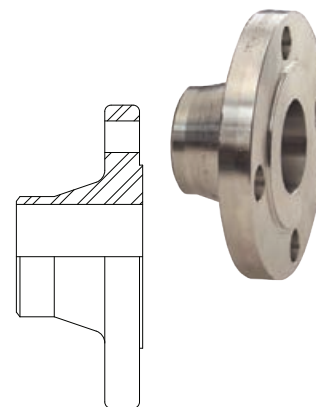

#### Flange Gaskets

**Features**

- Standard drop-ring type all 1/16" thick
- Reference page 1056 for joint sealant gasket material
- For flange dimensional information and diagrams please reference dixonvalve.com

Size	Neoprene Part #	Klingsil® C-4401 Part #
1"	NG10	AG10
1-1/4"	NG15	AG15
1-1/2"	NG20	AG20
2"	NG25	AG25
2-1/2"	NG30	AG30
3"	NG35	AG35
4"	NG40	AG40
5"	NG50	---
6"	NG60	AG60
8"	NG80	AG80



carbon steel



Klingsil® C-4401

### ANSI Flat Face Flange x Male NST (NH)

**Materials**

- Flange - black powder coated carbon steel
- Male adapter - black anodized aluminum

Size	PSI	Carbon Steel / Aluminum Part #
6" NST (NH)	175	T600-60F



### King Turned Back Weld-To-Metal Hose Nipples

**Application**

- For use with slip-on and lap joint flanges shown on previous page

**Features**

- MSS Length
- Phono-finish face (type CS), except 10" and 12" have smooth face (type C)

Size	Length	Schedule 40 Plated Carbon Steel Part #	Schedule 40 316 Stainless Steel Part #
1"	2"	NW10	RNW10-40
1-1/4"	2"	NW15	RNW15-40
1-1/2"	2"	NW20	RNW20-40
2"	2-1/2"	NW25	RNW25-40
2-1/2"	2-1/2"	NW30	RNW30-40
3"	2-1/2"	NW35	RNW35-40
4"	3"	NW40	RNW40-40
6"	3-1/2"	NW60	RNW60-40
8"	4"	NW80	RNW80-40
10"	5"	NW100	RNW100-40
12"	6"	NW120	RNW120-40



### Quick Release Couplings - Series-Q

**Applications**

- Designed for applications requiring a quick connection and/or disconnection of a pipe joint

**Comparable to**

- Victaulic's #78
- Grinnell's #7003

**Features**

- A locking pin through the handle prevents accidental opening of the coupling
- See page 962 for replacement gaskets

**Materials**

- Ductile iron body with zinc plating and steel safety clip



Nominal Size	Pipe O.D.	Maximum Working Pressure PSI at 70°F (21°C)	Maximum End Load (Lbs.)	Ductile Iron	
				Part # with EPDM gasket	Part # with Nitrile Rubber gasket
1-1/2"	1.900"	300	850	H315	H315BU
2"	2.375"	300	1329	H32	H32BU
2-1/2"	2.875"	300	2120	H325	H325BU
3"	3.500"	300	2886	H33	H33BU
4"	4.500"	300	4771	H34	H34BU
6"	6.625"	300	10341	H36	H36BU

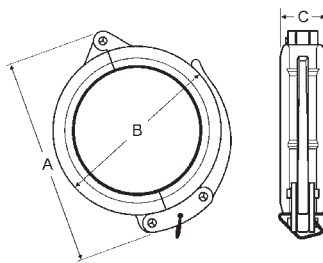

Dimensions

A	B	C
4-3/4"	3-1/2"	1"
5-1/2"	3-3/4"	1-7/8"
5-7/8"	4-3/4"	1-7/8"
7-1/4"	5-1/4"	1-7/8"
8-1/2"	6-1/2"	2"
10-5/8"	8-1/2"	2"





### Standard Couplings - Series-S, Style 11



**Applications**

- Designed for a wide range of applications including commercial/industrial construction, mining, and process piping

**Features**

- Housing design allows for optimum strength without excessive casting weight.
- See pages 962, 967-968 for replacement gaskets, nuts, and bolts

**Comparable to**

- Victaulic's #77
- Grinnell's #7001

**Material**

- Ductile iron body with rust-inhibiting paint

**Approvals**

- UL listed and Factory Mutual approved

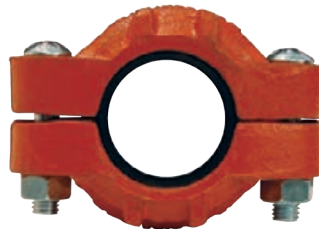

Nominal Size	Pipe O.D.	Maximum Working Pressure PSI at 70°F (21°C)	Maximum End Load (Lbs.)	Bolts			Ductile Iron		
				qty	size	length	Part # with EPDM gasket	Part # with Nitrile Rubber gasket	Part # with FKM gasket
1-1/2"	1.900"	1000	2835	2	3/8"	2"	C115	C115BU	---
2"	2.375"	1000	4430	2	1/2"	2-3/4"	C12	C12BU	C12V
2-1/2"	2.875"	1000	6492	2	1/2"	2-3/4"	C125	C125BU	---
3"	3.500"	1000	9621	2	1/2"	3"	C13	C13BU	C13V
4"	4.500"	1000	15904	2	5/8"	3-1/4"	C14	C14BU	C14V
6"	6.625"	1000	34472	2	3/4"	4-1/4"	C16	C16BU	---
8"	8.625"	800	46741	2	7/8"	5"	C18	C18BU	---
10"	10.750"	800	72610	2	7/8"	5"	C20	C20BU	---
12"	12.750"	800	102141	2	7/8"	5"	C24	C24BU	---

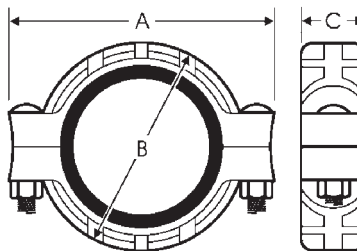

**Dimensions**

A	B	C
4-5/8"	3"	1-7/8"
5-15/64"	3-45/64"	1-27/32"
5-5/8"	4-1/4"	1-27/32"
6-21/32"	5"	1-27/32"
8-17/64"	6-3/8"	2-3/64"
11-7/32"	8-57/64"	2-3/64"
14-1/64"	11-3/8"	2-23/64"
16-5/8"	13-1/2"	2-5/8"
18-5/8"	15-1/2"	2-5/8"





## Lightweight Flexible Couplings - Series-L, Style 10

### Applications

- Designed for applications requiring moderate internal pressure or where weight is a factor such as general purpose, mining, irrigation, and compressed air where a deflection of 5% or less is required

### Feature

- See pages 962, 967-968 for replacement gaskets, nuts, and bolts

### Comparable to

- Victaulic's #75
- Grinnell's #7000

### Material

- Ductile iron body with rust inhibiting paint

### Approvals

- UL listed and Factory Mutual approved



Nominal Size	Pipe O.D.	Maximum Working Pressure PSI at 70°F (21°C)	Maximum End Load (Lbs.)	Bolts			Ductile Iron	
				qty	size	length	Part # with EPDM gasket	Part # with Nitrile Rubber gasket
1-1/2"	1.900"	500	1418	2	3/8"	2-1/4"	L215	L215BU
2"	2.375"	500	2215	2	3/8"	2"	L02	L02BU
2-1/2"	2.875"	300	3246	2	3/8"	2"	L025	L025BU
3"	3.500"	300	4811	2	1/2"	2-3/4"	L03	L03BU
4"	4.500"	300	6362	2	1/2"	2-3/4"	L04	L04BU
5"	5.563"	300	9722	2	5/8"	3-1/4"	L05	L05BU
6"	6.625"	300	13789	2	5/8"	3-1/4"	L06	L06BU
8"	8.625"	300	20449	2	3/4"	4-1/4"	L08	L08BU
10"	10.750"	350	29815	2	3/4"	4-1/4"	L010	L010BU
12"	12.750"	350	40581	2	7/8"	5"	L012	L012BU

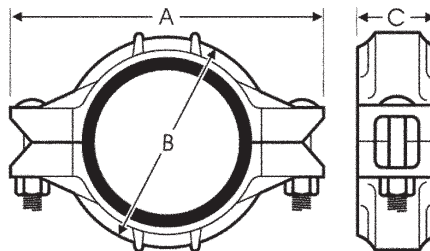

Dimensions

A	B	C
4-1/2"	2-29/32"	1-25/32"
4-7/8"	3-25/64"	1-27/32"
5-15/32"	3-45/64"	1-27/32"
6-27/64"	4-39/64"	1-27/32"
7-33/64"	5-7/8"	2-1/64"
9-17/32"	7-3/32"	2-1/64"
10-7/16"	8-7/64"	2-3/64"
13-15/32"	10-5/32"	2-13/32"
15-3/4"	12-39/64"	2-9/16"
18-23/64"	15-7/16"	2-9/16"

### Rigid Couplings - Series-R, Style 5



**Applications**

- Ideal for fire protection, plumbing, low pressure air, and drainage

**Features**

- Lightweight, low pressure
- Small gripping teeth hold the housing into the groove allowing a straight run of pipe and preventing any flex at the joint
- See pages 962, 967-968 for replacement gaskets, nuts, and bolts

**Approvals**

- UL listed and Factory Mutual approved



Nominal Size	Pipe O.D.	Maximum Working Pressure PSI at 70°F (21°C)	Maximum End Load (Lbs.)	Bolts			Galvanized Ductile Iron	
				qty	size	length	Part # with EPDM gasket	Part # with Nitrile Rubber gasket
2"	2.375"	175	4425	2	3/8"	2"	R72	R72BU
2-1/2"	2.875"	175	6490	2	3/8"	2"	R725	R725BU
3"	3.500"	175	9620	2	1/2"	2-3/4"	R73	R73BU
4"	4.500"	175	12720	2	1/2"	2-3/4"	R74	R74BU
6"	6.625"	175	27570	2	5/8"	31/4"	R76	R76BU
8"	8.625"	175	35050	2	3/4"	4-1/4"	R78	R78BU

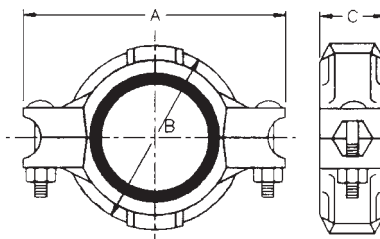

**Dimensions**

A	B	C
4-7/8"	3-17/32"	1-27/32"
5-5/8"	3-45/64"	1-3/4"
6-3/8"	4-41/64"	1-27/32"
7-45/64"	5-15/16"	2"
10-25/32"	8-7/64"	2-3/64"
13-25/32"	10"	2-21/64"

## Grooved Bolted Clamps

### Features

- Bolt torque: 20 ft. lbs.
- Precision casting and machined dimensions provide an exact fit and great appearance
- Use of lock nuts prevents clamps from loosening in high vibration applications
- Leak-tight connection
- Intended for tank truck applications only 
- Unlike steel groove clamps that secure pipe ends with high clamp force against the tubing walls, the Dixon® bolted clamp takes the full bolt force and locks in the groove of the tube preventing distortion of the tube diameter
- White nitrile rubber for use in dry bulk food applications

### Specifications

- Temperature ratings for FKM-B is **20°F to 300°F (-7°C to 149°C)**
- Temperature ratings for Baylast is **-20°F to 180°F (-29°C to 82°C)**
- 2" pressure rating: **400 PSI**
- 3" pressure rating: **170 PSI**
- 4" pressure rating: **120 PSI**

### Approvals

- FKM-B rated for 100% biodiesel and Ethanol
- Nitrile rubber rated for petroleum service, Ethanol to E100, and biodiesel to B20
- Baylast™ rated for petroleum service, Ethanol to E100, and biodiesel to B100



clamp with black nitrile rubber gasket

Note: Supplied clamp gasket must be installed prior to use, ships separately.

Size	Gasket Material	Aluminum Part #
2"	FKM-B	DBV-VB200
3"		DBV-VB300
4"		DBV-VB400
2"	Nitrile rubber	DBV-BN200
3"		DBV-BN300
4"		DBV-BN400
2"	Baylast	DBV-BL200
3"		DBV-BL300
4"		DBV-BL400
4"	white nitrile rubber	DBV-WB400

### Replacement Gaskets

Size	Material	Part #
2"	FKM-B	G200VB
3"		G300VB
4"		G400VB
3"	Nitrile rubber	G300T
4"		G400T
2"	Baylast	G200BL
3"		G300BL
4"		G400BL
4"	white nitrile rubber	G400N

### Painted Iron Clamps with Baylast Gaskets

#### Feature

- Painted red

#### Approvals

- Baylast seal is rated for biodiesel, Ethanol, diesel, gas, and ULSD



Size	Maximum PSI	Iron Part #
2"	<b>500</b>	L02BL
3"	<b>300</b>	L03BL
4"	<b>300</b>	L04BL

P

### Mechanical Tees - Series-T



**Application**

- Provides a fast easy way to install a threaded connection along a length of pipe; after drilling or cutting a hole in the pipe at the location of the branch connection, simply attach the clamps around the pipe for a leak-free threaded outlet connection; see chart below for drilling hole specifications

**Features**

- Supplied with EPDM gasket
- See pages 962, 967-968 for replacement gaskets, nuts, and bolts

**Material**

- Ductile iron body with rust inhibiting paint

**Specification**

- Maximum operating pressure: 300 PSI at 70°F (21°C)

**Approvals**

- UL listed and Factory Mutual approved

**Comparable to**

- Victaulic's #920
- Grinnell's #7045

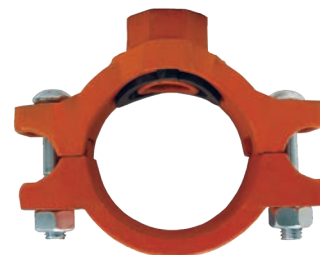

Nominal Size	Branch Size	Hole Saw Diameter	Maximum End Load (Lbs.)	Bolts			Ductile Iron Part #
				qty	size	length	
2"	1"	1-1/2"	1-5/8"	2	3/8"	2"	MT2010
	1-1/4"	1-3/4"	1-7/8"	2	3/8"	2"	MT20125
	1-1/2"	1-3/4"	1-7/8"	2	3/8"	2"	MT20150
2-1/2"	1-1/4"	2"	2-1/8"	2	1/2"	2-5/8"	MT250125
3"	1"	1-1/2"	1-5/8"	2	1/2"	2-3/4"	MT3010
	1-1/2"	2"	2-1/8"	2	1/2"	2-3/4"	MT30150
4"	1"	1-1/2"	1-5/8"	2	1/2"	2-3/4"	MT4010
	1-1/4"	2"	2-1/8"	2	1/2"	2-3/4"	MT40125
	1-1/2"	2"	2-1/8"	2	1/2"	2-3/4"	MT40150
	2"	2-1/2"	2-5/8"	2	1/2"	2-3/4"	MT4020
	2-1/2"	2-3/4"	2-7/8"	2	1/2"	2-3/4"	MT40250
6"	3"	3-1/2"	3-5/8"	2	1/2"	2-3/4"	MT4030
	1-1/4"	2-1/2"	2-5/8"	2	5/8"	3-1/4"	MT60125
	1-1/2"	2-1/2"	2-5/8"	2	5/8"	3-1/4"	MT60150
	2"	2-1/2"	2-5/8"	2	5/8"	3-1/4"	MT6020
	3"	3-1/2"	3-5/8"	2	5/8"	3-1/4"	MT6030

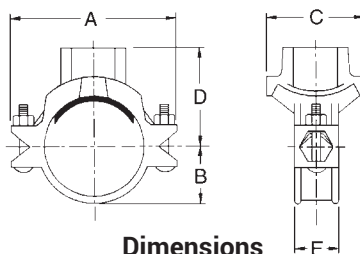

Dimensions

A	B	C	D	E
4-1/2"	1-3/8"	2-3/4"	2-1/4"	1-7/8"
4-1/2"	1-3/8"	2-3/4"	2-1/2"	1-7/8"
4-1/2"	1-3/8"	2-3/4"	2-1/2"	1-7/8"
5-5/32"	1-11/16"	3"	2-31/32"	2"
5-13/16"	1-11/16"	3-11/32"	3"	2"
6-11/32"	2-1/8"	3-3/32"	3-1/16"	2"
6-11/32"	2-1/8"	3-3/4"	3-3/8"	2"
7-5/16"	2-9/16"	3-3/32"	3-1/2"	2"
7-5/16"	2-9/16"	3-3/4"	3-7/8"	2"
7-5/16"	2-9/16"	3-3/4"	3-7/8"	2"
7-5/16"	2-9/16"	4-1/8"	4"	2"
7-5/16"	2-9/16"	4-3/8"	4"	2"
7-5/16"	2-9/16"	5-1/4"	4-1/4"	2"
10-5/32"	3-11/16"	4-1/8"	4-7/8"	2-1/4"
10-5/32"	3-11/16"	4-1/8"	4-7/8"	2-1/4"
10-5/32"	3-11/16"	4-1/8"	5"	2-1/4"
10-5/32"	3-11/16"	5-1/4"	5-3/8"	2-1/4"

### Flange Adapters - Series-FA

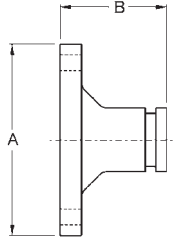

**Application**

- Used to connect an ANSI Class 125 and 150 flange to a grooved pipe using a grooved clamp

**Feature**

- Provides a rigid one-piece connection that can be disconnected by removing the clamp assembly, or assemble to another flange, position bolt heads on the adapter (grooved) side

**Material**

- Ductile iron body with rust inhibiting paint

Nominal Size	Pipe O.D.	Maximum Working Pressure PSI at 70°F (21°C)	Flange Dimensions		Bolts		Ductile Iron Part #
			A	B	Qty	size	
2"	2.375"	300	6"	2-3/8"	4	5/8"	FA20
3"	3.500"	300	7-1/4"	2-3/8"	4	5/8"	FA30
4"	4.500"	300	8-1/2"	2-3/8"	8	5/8"	FA40
6"	6.625"	300	11"	2-9/16"	8	3/4"	FA60
8"	8.625"	300	13-1/4"	3"	8	3/4"	FA80

### ANSI Split Flanges - Series-SF

**Application**

- Provides a direct connection between a grooved adapter and an ANSI Class 125 and 150 raised face flanged component

**Features**

- Can be used with flat face flanges by removing the raised projections on the outside face of the flange
- Nitrile rubber gaskets are available upon request

**Material**

- Ductile iron body with rust inhibiting paint

**Approvals**

- UL Listed and Factory Mutual approved

**Comparable to**

- Victaulic's #741
- Grinnell's #7012

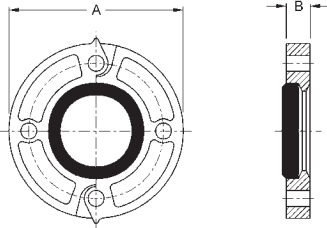

Nom. Size	Pipe O.D.	Max. Work. Press. PSI at 70°F (21°C)	Flange Dims.		Bolts		Ductile Iron with Gasket Part # <sup>1</sup>	Replacement EPDM Gaskets Part # <sup>2</sup>
			A	B	qty	size		
2"	2.375"	300	6"	13/16"	4	5/8"	ANSI20	FLG200E
2-1/2"	2.875"	300	7"	13/16"	4	5/8"	ANSI25	FLG250E
3"	3.500"	300	7-1/2"	13/16"	4	5/8"	ANSI30	FLG300E
4"	4.500"	300	9"	15/16"	8	5/8"	ANSI40	FLG400E
6"	6.625"	300	11"	1"	8	3/4"	ANSI60	FLG600E
8"	8.625"	300	13-1/2"	1-1/8"	8	3/4"	ANSI80	FLG800E

- <sup>1</sup> With EPDM gasket
- <sup>2</sup> Replacement gasket



### Reducing Adapters - Series-RA

**Material**

- Ductile iron body with rust inhibiting paint

**Comparable to**

- Victaulic's #50
- Grinnell's #7072

**Approvals**

- UL listed and Factory Mutual approved

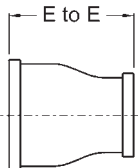

Nominal Size	Nominal Size	Dimensions E to E	Ductile Iron Part #
2"	1-1/2"	2.5"	RAGG20150
2-1/2"	2"	2.5"	RAGG25020
3"	2"	2.5"	RAGG3020
	2-1/2"	2.5"	RAGG30250
4"	2"	3.0"	RAGG4020
	2-1/2"	3.0"	RAGG40250
	3"	3.0"	RAGG4030
5"	4"	3.5"	RAGG5040
	2"	4.0"	RAGG6020
6"	2-1/2"	4.0"	RAGG60250
	3"	4.0"	RAGG6030
	4"	4.0"	RAGG6040

## Grooved End Fittings - Series 45

**Feature**

- Designed to provide minimum pressure drop and uniform strength

**Material**

- Ductile iron body with rust inhibiting paint

**Specification**

- Maximum operating pressure: **500 PSI** at ambient temperature **70°F (21°C)**

Nominal Size	Dimensions C to E	Ductile Iron Part #
2"	2"	L2045
2-1/2"	2-1/4"	L2545
3"	2-1/2"	L3045
4"	3"	L4045
5"	3-1/4"	L5145
6"	3-1/2"	L6045
8"	4-1/4"	L8045

**Series-45**

**Approvals**

- Underwriters Listed and Factory Mutual approved

**Comparable to**

- Victaulic's #110
- Grinnell's #7051

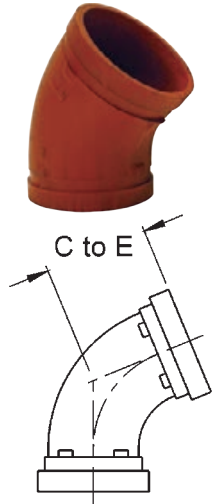

**Feature**

- Designed to provide minimum pressure drop and uniform strength

**Material**

- Ductile iron body with rust inhibiting paint

**Specification**

- Maximum operating pressure: **500 PSI** at ambient temperature **70°F (21°C)**

Nominal Size	Dimensions C to E	Ductile Iron Part #
2"	3-1/4"	L502
2-1/2"	3-3/4"	L5025
3"	4-1/4"	L503
4"	5"	L504
6"	6-1/2"	L506
8"	7-3/4"	L508

**Series-90**

**Approvals**

- Underwriters Listed and Factory Mutual approved

**Comparable to**

- Victaulic's #10
- Grinnell's #7050

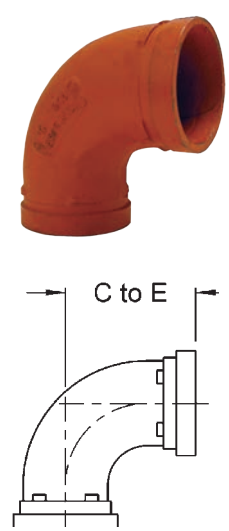

**Feature**

- Designed to provide minimum pressure drop and uniform strength

**Material**

- Ductile iron body with rust inhibiting paint

**Specification**

- Maximum operating pressure: **500 PSI** at ambient temperature **70°F (21°C)**

Nominal Size	Dimensions C to E	Ductile Iron Part #
2"	3-1/4"	T602
2-1/2"	3-3/4"	T6025
3"	4-1/4"	T603
4"	5"	T604
6"	6-1/2"	T606
8"	7-3/4"	T608

**Series-T**

**Approvals**

- Underwriters Listed and Factory Mutual approved

**Comparable to**

- Victaulic's #20
- Grinnell's #7060

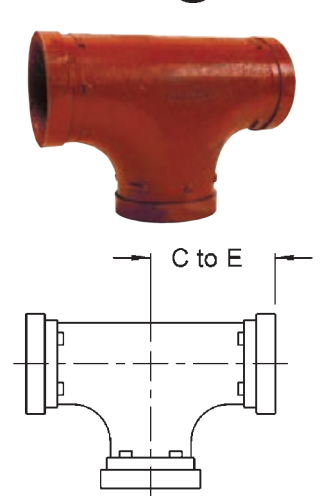

### ANSI Caps with Tapped Outlet - Series-EC

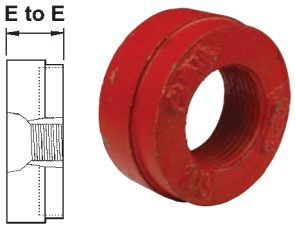

- Feature**
- Painted with rust-inhibiting paint

Nominal Size	Outlet	Dimensions E to E	Ductile Iron Part #
2"	1"	7/8"	EC201
2-1/2"	1"		EC251
3"	1"		EC301
4"	1"	1"	EC401
	2"		EC402
6"	1"		EC601



### Blank Caps - Series-BE

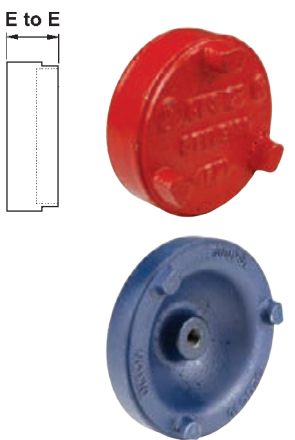

- Feature**
- Painted with rust-inhibiting paint
- Comparable to**
- Victaulic's #60
  - Grinnell's #7074
- Approvals**
- Underwriters Listed and Factory Mutual approved

Nominal Size	Dimensions E to E	Ductile Iron Part #
2"	7/8"	BEC20
2-1/2"	7/8"	BEC25
3"	7/8"	BEC30
5"	1-19/32	BEC50
4"	1"	BEC40
6"	1"	BEC60
8"	1-3/16"	BEC80
8"	1-7/8"	BEC80

### Long Pipe Style Nipples - Series-AN

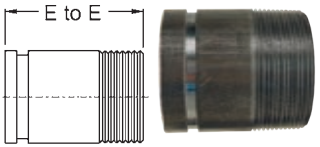

Groove x NPT	Dimensions E to E	Carbon Steel Part #
2"	4"	A712
2-1/2"		A7125
3"		A713
4"	6"	A714
5"		A715
6"		A716

### Grooved End x Weld Nipples



Nominal Size	Aluminum Part #	Carbon Steel Part #	316 Stainless Steel Part #
2"	AVN2000-200	VN2000-200	VNR2000-200
2-1/2"	AVN2500-200	VN2500-200	VNR2500-200
3"	AVN3000-200	VN3000-200	VNR3000-200
4"	AVN4000-200	VN4000-200	VNR4000-200

NOTE: For additional information on pipe dimensions, please reference dixonvalve.com.

### Grooved End Butterfly Valves

- Application**
- For water and air
- Materials**
- Body: ductile iron, epoxy coated; disc: ductile iron, EPDM encapsulated; stem: stainless steel; notch plate: zinc plated steel; seals: EPDM
- Specifications**
- Working pressure: **300 PSI**
  - Maximum temperature: **210°F (99°C)**



Size	Ductile Iron Part #
2"	GIBFV200
2-1/2"	GIBFV250
3"	GIBFV300
4"	GIBFV400
6"	GIBFV600
8"	GIBFV800



## Grooved Fitting Gaskets

- Check gasket color code to be certain it is recommended for the service intended
- Use lubricant on gasket (reference next page)
- For services not listed contact Dixon® for recommendations

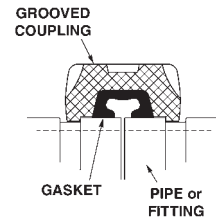

### Features

- Color code: black with blue stripe
- Resistant to oxidizing acids, petroleum oils, hydraulic fluids, halogenated hydrocarbons, and lubricants

### FKM Gaskets

#### Specification

- Temperature range: -13°F to 350°F (-11°C to 177°C)

Size	FKM Part #
2"	G200V
3"	G300V
4"	G400V
6"	G600V
8"	G800V
10"	G1000V
12"	G1200V



### EPDM Gaskets

#### Specification

- Temperature range: -22°F to 230°F (-30°C to 110°C)

### Features

- Color code: black with green stripe
- For water, dilute acids, alkalies, salts, and many chemical services not involving hydrocarbons, oils, or gases
- Excellent oxidation resistance 
- Not for use with hydrocarbons

Size	EPDM Part #
1-1/2"	G150E
2"	G200E
2-1/2"	G250E
3"	G300E
4"	G400E
5"	G500E
6"	G600E
8"	G800E
10"	G1000E
12"	G1200E



### Nitrile Rubber Gaskets

#### Specification

- Temperature range: -24°F to 176°F (-31°C to 80°F)

### Features

- For petroleum products, vegetable oils, mineral oils, and air contaminated with petroleum oils
- Not for use in hot water services 

Size	Black Nitrile Rubber with Orange Stripe Part #	White Nitrile Rubber Part #
1-1/2"	G150T	---
2"	G200T	---
2-1/2"	G250T	---
3"	G300T	---
4"	G400T	G400N
5"	G500T	---
6"	G600T	---
8"	G800T	---
10"	G1000T	---
12"	G1200T	---



## Grooved Fitting Accessories

### Nuts and Bolts

**Features**

- The nuts are a heavy hexagon design
- Specifically designed for use with the couplings on pages 959 - 963

**Approval**

- Conforms to ASTM A183



Bolt Thread	Bolt Length	Torque (Ft. Lbs.)	Electroplated Carbon Steel Part #
3/8"	2"	30	BLT38200
	2-1/4"		BLT38225
1/2"	2-1/2"	50	BLT50212
	2-3/4"		BLT50234
	3"		BLT50300
5/8"	3-1/4"	75	BLT58314
3/4"	4-1/4"	75	BLT75414
7/8"	5"	200	BLT78500

### Groove Lube

**Features**

- Water soluble
- Non-toxic
- Non-corrosive
- Non-flammable
- Should not be used with High Density Polyethylene (HDPE) pipe 



**Approval**

- NSF approved for use with potable water

Size	Container	Part #
1 qt.	Tub	GROOVLUB32

## High Density Polyethylene (HDPE) Couplings

### Applications

- Designed for mechanically joining high density polyethylene pipe and fittings

### Feature

- Uses four bolts to drive the sharply machined housing teeth into the outside of the pipe

### Material

- Ductile iron body with rust inhibiting paint

### Comparable to

- Grinnell's #9095

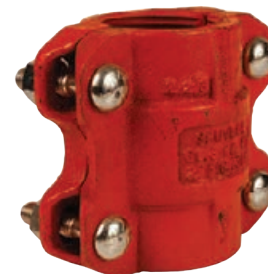
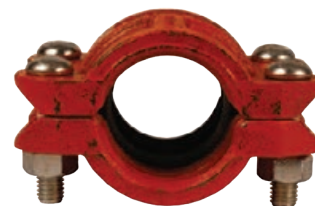

Nominal Size	Pipe O.D.	Bolts			Ductile Iron	
		qty	size	length	Part # with EPDM gasket	Part # with Nitrile Rubber gasket
2"	2.375"	4	1/2"	2-3/8"	HDPE200	HDPE200BU
3"	3.500"	4	1/2"	3"	HDPE300	HDPE300BU
4"	4.500"	4	1/2"	3"	HDPE400	HDPE400BU
6"	6.625"	4	5/8"	3-1/2"	HDPE600	HDPE600BU

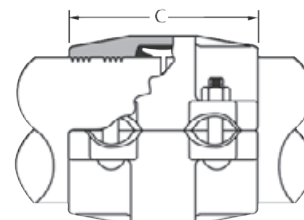
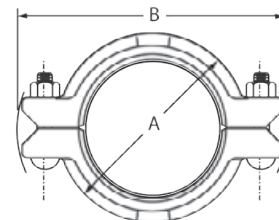

### Dimensions

A	B	C
3-3/8"	5-1/2"	4-5/8"
4-5/8"	6-3/4"	4-5/8"
5-1/4"	8"	5-3/4"
7-1/2"	11"	5-7/8"



## Y Line Strainers

### Cast Iron

**Features**

- Plug ported for blowdown service
- No replacement screens available

**Material**

- Graphite gasket

**Specification**

- Working pressure: **400 PSI WOG, 250 PSI steam**



Female NPT	Description	Cast Iron Part #
1/4"	20 x 20 mesh	Y001
3/8"		Y002
1/2"		Y003
3/4"		Y004
1"		Y005
1-1/4"		Y006
1-1/2"		Y007
2"		Y008

### Cast Bronze

**Specification**

- Working pressure: **400 PSI WOG, 125 PSI steam**



Female NPT	Description	Cast Bronze Part #	304 Stainless Replacement Screens Part #
1/4"	50 x 50 mesh	59-001	G3271-00
3/8"		59-002	G2457-00
1/2"		59-003	G2457-00
3/4"	20 x 20 mesh	59-004	G3224-00
1"		59-005	G3225-00
1-1/4"		59-006	G3231-00
1-1/2"		59-007	G3229-00
2"		59-008	G3230-00



replacement screen

### Polypropylene

**Features**

- Protects and prevents clogging of pipelines, pumps, and spray tips
- Easy access for cleaning

**Material**

- Glass-filled polypropylene body

**Specification**

- Maximum operating pressure: **90 PSI at 70°F (21°C)**



Female NPT	Description	Polypropylene Part #	304 Stainless Replacement Screens Part #
3/4"	50 mesh	PYLS7550	64178
1"		PYLS10050	64292
1-1/2"		PYLS15050	64261
2"		PYLS20050	64261



replacement screen

## Polypropylene T Line Strainers

**Feature**

- White polypropylene allows easy inspection

**Specification**

- Maximum operating pressure: **100 PSI at 70°F (21°C)**



Female NPT	Description	Polypropylene Part #	304 Stainless Replacement Screens Part #
3/4"	40 mesh	PTLS7540	61405
1"		PTLS10040	61405

## LP Gas Couplings and Adapters

### Approvals

- Products meet or exceed the requirements of Compressed Gas Association (CGA), the National Fire Protection Association (NFPA), the Canadian Gas Association, American Society of Mechanical Engineers (ASME), and Underwriters' Laboratories (UL)

### Male Acme x Male NPT Adapters

Male Acme	Male NPT	Female NPT	Brass Part #
1-3/4"	1-1/4"	--	ME217
2-1/4"	1-1/4"	--	ME233
2-1/4"	1-1/2"	1"	ME502-12/8 <sup>1</sup>
3-1/4"	2"	--	ME503-16

<sup>1</sup> Dual threads - male outside / female inside



ME217

ME233



ME502-12/8

ME503-16

### Male Acme x Female NPT Adapters

Male Acme	Female NPT	Brass Part #
1-3/4"	1"	ME214
3-1/4"	2"	ME252-16



### Male Acme x Male NPT Adapters

Male Acme	Male NPT	Steel Part #
1-3/4"	1-1/4"	ME217S
2-1/4"	1-1/4"	ME233S
3-1/4"	2"	ME503S-16



ME217S

ME503S-16

### Male Acme x Female NPT Adapter

Male Acme	Female NPT	Steel Part #
3-1/4"	2"	ME252S-16



### Female Acme x Male Acme Adapters

Female Acme	Male Acme	Material	Part #
3-1/4"	1-3/4"	brass	ME612
		steel	ME612S



brass

steel

### LP Gas Couplings and Adapters



ME112 ME120



ME130



ME112S ME121S



ME130S

#### Female Acme x Male NPT Filler Couplings, Brass Nut

Female Acme	Male NPT	Material	Part #
1-3/4"	1"	brass nut, brass nipple	ME112
2-1/4"	1-1/4"	brass nut, brass nipple	ME120
		brass nut, steel nipple	ME120S
3-1/4"	2"	brass nut, steel nipple	ME130

#### Female Acme x Male NPT Filler Couplings, Steel Nut

Female Acme	Male NPT	Steel Part #
1-3/4"	1"	ME112S
2-1/4"	1-1/4"	ME121S
3-1/4"	2"	ME130S

#### Acme Gaskets



Size	Nitrile Part #
1-3/4"	MEW2
2-1/4"	MEW5
3-1/4"	MEW6

#### Clamp Style Hose Couplings

##### Feature

- 32B and 32S sizes offer a female Acme swivel to eliminate the need to add additional weight and bulk to the hose assembly

##### Materials

- Clamp sections and hose barbs are made of steel and ductile iron



ME3162-20



ME3162-32B

Hose Barb	Thread Size	Material	Part #
1"	1" male NPT	steel nipple, 2-piece ductile iron clamp	ME3162-16
1-1/4"	1-1/4" male NPT	steel nipple, 2-piece ductile iron clamp	ME3162-20
	1" male NPT	steel nipple, 2-piece ductile iron clamp	ME3162-24
2"	2" male NPT	steel nipple, 2-piece ductile iron clamp	ME3162-32
	3-1/4" female Acme	steel nipple, brass nut, 2-piece ductile iron clamp	ME3162-32B
	3-1/4" female Acme	steel nipple, steel nut, 2-piece ductile iron clamp	ME3162-32S

#### Acme Spanner Wrench

##### Application

- Used on 1-3/4", 2-1/4", 3-1/4", and 4-1/4" fittings



Aluminum  
Part #

MEP120B

## LP Gas Hose Caps and Plugs

### Metal Caps

Female Acme Threads	Description	Material	Part #
1-3/4"	cap with ring and chain	brass	ME229-1
	cap with ring and chain	steel	ME229S-1
2-1/4"	cap with knob plug and chain	brass	ME431F-1
	cap with knob plug, ring and chain	steel	ME431FS-1
3-1/4"	cap with knob plug, ring and chain	brass	ME441F-1
	cap with knob plug, ring and chain	steel	ME441FS-1



ME229



ME441F

### Plastic Caps

Female Acme Threads	Description	Plastic Part #
1-3/4"	cap with ring and chain, yellow	ME109-1
	cap with chain assembly, for anhydrous service	ME109-NH3-1



ME109-1



ME109-NH3-1

### Plastic Dust Plugs

Male Acme Threads	Description	Plastic Part #
1-3/4"	plug with dust seal and chain assembly, yellow	ME179-1
2-1/4"	plug with dust seal and chain assembly, yellow	ME180-1
3-1/4"	plug with dust seal and chain assembly, yellow	ME181-1



ME179-1



ME180-1



ME181-1



### Instrumentation Fittings

**Applications**

- High pressure
- High temperature
- Nitrogen
- Helium
- Flammable gases
- Hydraulic gases
- Corrosive media
- Pneumatic automation

**Installation Instructions**

1. Cut tubing squarely and clean tube end thoroughly to remove burrs.
2. Insert the tubing into the assembly making sure the tubing seats firm against the shoulder of the body and the nut is finger tight.
3. Tighten the nut with a wrench 1-1/4 turns while holding the body with a second wrench.

**Features**

- Instrumentation fittings come completely assembled
- Double collet (ferrule) swaging action
- Two positive seal points

**Suggested Working Pressures (PSI)**

Wall Thk.	.028	.035	.049	.065	.083	.095	.109
1/4"	4,000	5,100	7,500	10,100	---	---	---
3/8"	---	3,300	4,700	6,600	---	---	---
1/2"	---	2,600	3,700	5,000	6,600	---	---
5/8"	---	---	2,900	3,900	5,200	6,000	---
3/4"	---	---	2,400	3,200	4,200	4,900	5,700

**Specifications**

- Temperature range: -325°F to 1200°F (-198°C to 648°C)
- Pressure ratings: see chart to the left; ratings listed are for reference only

**Safety Guidelines**

- Never connect, disconnect, or remake a fitting with pressure in the system.
- Make sure all fittings are properly installed.
- It is not recommended to go beyond the pressure rating of the tubing. Elongation could occur in the tubing, shrinking the wall thickness and causing potential harm.
- For proper sealing, it is recommended that the tubing and fittings be of like material.
- Always use proper thread lubricant and sealants on tapered pipe threads.
- Never bleed a system by loosening a fitting.

**Approvals**

- ASTM 316 stainless steel material construction
- Fully interchangeable with Swagelok® and Parker A-Lok®; all fittings are ASTM F1387 Certified

**Male Connectors**

Tube O.D.	Male NPT	Interchanges	316 Stainless Steel Part #	Pkg Qty
1/8"	1/8"-27	200-1-2	2-DMC-2	10
	1/4"-18	200-1-4	2-DMC-4	10
1/4"	1/8"-27	400-1-2	4-DMC-2	10
	1/4"-18	400-1-4	4-DMC-4	10
	3/8"-18	400-1-6	4-DMC-6	10
	1/2"-14	400-1-8	4-DMC-8	10
3/8"	1/4"-18	600-1-4	6-DMC-4	10
	3/8"-18	600-1-6	6-DMC-6	10
	1/2"-14	600-1-8	6-DMC-8	10
1/2"	1/4"-18	810-1-4	8-DMC-4	10
	3/8"-18	810-1-6	8-DMC-6	10
	1/2"-14	810-1-8	8-DMC-8	10
5/8"	1/2"-14	1010-1-8	10-DMC-8	10
3/4"	1/2"-14	1210-1-8	12-DMC-8	10
	3/4"	1210-1-12	12-DMC-12	10
	1"	1210-1-16	12-DMC-16	10
1"	3/4"	1610-1-12	16-DMC-12	10
	1"	1610-1-16	16-DMC-16	10

**Female Connectors**

Tube O.D.	Female NPT	Interchanges	316 Stainless Steel Part #	Pkg Qty
1/8"	1/8"-27	200-7-2	2-DFC-2	10
1/4"	1/8"-27	400-7-2	4-DFC-2	10
	1/4"-18	400-7-4	4-DFC-4	10
3/8"	1/4"-18	600-7-4	6-DFC-4	10
	1/2"-14	600-7-8	6-DFC-8	10
1/2"	1/2"-14	810-7-8	8-DFC-8	10
5/8"	1/2"	1010-7-8	10-DFC-8	10
3/4"	1/2"	1210-7-8	12-DFC-8	10
	3/4"	1210-7-12	12-DFC-12	10
1"	1"	1610-7-16	16-DFC-16	10

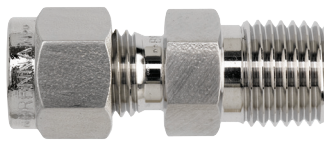

P



### Instrumentation Fittings

#### Unions

Tube O.D.	Interchanges	316 Stainless Steel Part #	Pkg Qty
1/8" x 1/8"	200-6	2-DU	10
1/4" x 1/8"	400-6-2	4-DU-2	10
1/4" x 1/4"	400-6	4-DU	10
3/8" x 1/4"	600-6-4	6-DU-4	10
3/8" x 3/8"	600-6	6-DU	10
1/2" x 1/2"	810-6	8-DU	10
5/8" x 5/8"	1010-6	10-DU	10
3/4" x 3/4"	1210-6	12-DU	10
1" x 1"	1610-6	16-DU	10



#### Bulkhead Unions

Tube O.D.	Interchanges	316 Stainless Steel Part #	Pkg Qty
1/4"	400-61	4-DBHU-4	10
3/8"	600-61	6-DBHU-6	10
1/2"	810-61	8-DBHU-8	10
5/8"	1010-61	10-DBHU-10	10
3/4"	1210-16	12-DBHU-12	10
1"	1610-16	16-DBHU-16	10



#### Reducers

Tube O.D.	Interchanges	316 Stainless Steel Part #	Pkg Qty
1/4" x 1/8"	400-R-2	4-DRATT-2	10
3/8" x 1/4"	600-R-4	6-DRATT-4	10
3/8" x 1/2"	600-R-8	6-DRATT-8	10
1/2" x 3/4"	810-R-12	8-DRATT-12	10
3/4" x 1/2"	1210-R-8	12-DRATT-8	10
3/4" x 1"	1210-R-16	12-DRATT-16	10

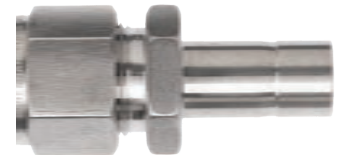

#### Male Elbows

Tube O.D.	Male NPT	Interchanges	316 Stainless Steel Part #	Pkg Qty
1/4"	1/8"-27	400-2-2	4-DME-2	10
	1/4"-18	400-2-4	4-DME-4	10
3/8"	1/4"-18	600-2-4	6-DME-4	10
	3/8"-18	600-2-6	6-DME-6	10
1/2"	1/2"-14	810-2-8	8-DME-8	10
3/4"	1/2"-14	1210-2-8	12-DME-8	10
	3/4"	1210-2-12	12-DME-12	10
1"	3/4"	1610-2-12	16-DME-12	10
	1"	1610-2-16	16-DME-16	10



#### Female Elbows

Tube O.D.	Female NPT	Interchanges	316 Stainless Steel Part #	Pkg Qty
1/4"	1/8"-27	400-8-2	4-DFE-2	10
3/8"	1/4"-18	600-8-4	6-DFE-4	10
1/2"	1/2"-14	810-8-8	8-DFE-8	10
3/4"	1/2"	1210-8-8	12-DFE-8	10
3/4"	3/4"	1210-8-12	12-DFE-12	10
1"	1"	1610-8-16	16-DFE-16	10



### Instrumentation Fittings

#### Union Elbows



Tube O.D.	Interchanges	316 Stainless Steel Part #	Pkg Qty
1/4"	400-9	4-DELU-4	10
3/8"	600-9	6-DELU-6	10
1/2"	810-9	8-DELU-8	10
5/8"	1010-9	10-DELU-10	10
3/4"	1210-9	12-DELU-12	10
1"	1610-9	16-DELU-16	10

#### Male Branch Tees



Tube O.D.	Male NPT	Interchanges	316 Stainless Steel Part #	Pkg Qty
1/8"	1/8"-27	200-3TTM	2-DTTM-2	10
1/4"	1/4"-18	400-3-4TTM	4-DTTM-4	10
1/2"	3/8"	810-3TTM	8-DTTM-6	10
	1/2"	810-3-8TTM	8-DTTM-8	10
3/4"	1/2"	1210-3-8TTM	12-DTTM-8	10
	3/4"	1210-3TTM	12-DTTM-12	10
1"	3/4"	1610-3-12TTM	16-DTTM-12	10
	1"	1610-3-16TTM	16-DTTM-16	10



#### Female Branch Tees

Tube O.D.	Female NPT	Interchanges	316 Stainless Steel Part #	Pkg Qty
1/4"	1/4"-18	400-3-4TTF	4-DTTF-4	10

#### Union Tees

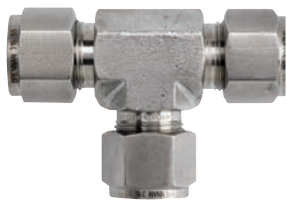

Tube O.D.	Interchanges	316 Stainless Steel Part #	Pkg Qty
1/4"	400-3	4-DTTT-4	10
3/8"	600-3	6-DTTT-6	10
1/2"	810-3	8-DTTT-8	10
5/8"	1010-3	10-DTTT-10	10
3/4" x 3/8"	1210-3-12-6	12-DTTT-6	10
3/4" x 1/2"	1210-3-12-8	12-DTTT-8	10
3/4"	1210-3	12-DTTT-12	10
1" x 3/4"	1610-3-12-16	16-DTTT-12	10
1"	1610-3	16-DTTT-16	10

#### Male Run Tees

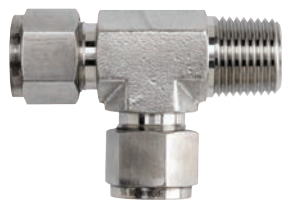

Tube O.D.	Male NPT	Interchanges	316 Stainless Steel Part #	Pkg Qty
1/8"	1/8"-27	200-3TMT	2-DTMT-2	10
1/4"	1/4"-18	400-3-4TMT	4-DTMT-4	10
3/8"	1/4"-18	600-3TMT	6-DTMT-4	10
1/2"	3/8"	810-3TMT	8-DTMT-6	10
1/2"	1/2"	810-3-8TMT	8-DTMT-8	10
3/4"	3/4"	1210-3TMT	12-DTMT-12	10
1"	1"	1610-3-16TMT	16-DTMT-16	10

P

## Instrumentation Fittings

### Front Ferrules

Tube O.D.	Interchanges	316 Stainless Steel Part #	Pkg Qty
1/8"	203-1	DFC-2	10
1/4"	403-1	DFC-4	10
3/8"	603-1	DFC-6	10
1/2"	813-1	DFC-8	10
5/8"	1013-1	DFC-10	10
3/4"	1213-1	DFC-12	10
1"	1613-1	DFC-16	10



### Rear Ferrules

Tube O.D.	Interchanges	316 Stainless Steel Part #	Pkg Qty
1/8"	204-1	DRC-2	10
1/4"	404-1	DRC-4	10
3/8"	604-1	DRC-6	10
1/2"	814-1	DRC-8	10
5/8"	1014-1	DRC-10	10
3/4"	1214-1	DRC-12	10
1"	1614-1	DRC-16	10



### Nuts

Tube O.D.	Interchanges	316 Stainless Steel Part #	Pkg Qty
1/4"	402-1	DN-4	10
3/8"	602-1	DN-6	10
1/2"	812-1	DN-8	10
5/8"	1012-1	DN-10	10
3/4"	1212-1	DN-12	10
1"	1612-1	DN-16	10



### Caps

Tube O.D.	Interchanges	316 Stainless Steel Part #	Pkg Qty
1/4"	400-C	4-DCAP	10
3/8"	600-C	6-DCAP	10
1/2"	810-C	8-DCAP	10
5/8"	1010-C	10-DCAP	10
3/4"	1210-C	12-DCAP	10
1"	1610-C	16-DCAP	10

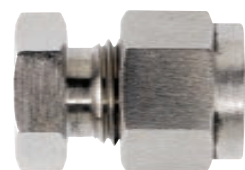

### Plugs

Tube O.D.	Interchanges	316 Stainless Steel Part #	Pkg Qty
1/4"	400-P	4-DFPLUG	10
3/8"	600-P	6-DFPLUG	10
1/2"	810-P	8-DFPLUG	10
5/8"	1010-P	10-DFPLUG	10
3/4"	1210-P	12-DFPLUG	10
1"	1610-P	16-DFPLUG	10





## Compression Fittings

### Applications

- For use with copper, aluminum, and Parflex thermoplastic tubing
- Not recommended for steel tubing or applications using gaseous media

### Features

- No flaring, soldering, or other preparation of tubing necessary to assemble
- Manufactured for connection to low and medium-pressure tubing connection work where excessive vibration or tube movement is not involved

### Approvals

- UL listed for flammable liquid
- Compression fittings meet functional requirements of SAE J-512 and ASA

### Assembly Instructions

1. Slide nut, then sleeve, onto tubing. The thread end of the nut must face outward.
2. Insert the tube into the fitting. Be sure the tube is bottomed on the fitting shoulder.
3. Assemble nut to body, then tighten hand-tight. Then follow the number of wrench turns as indicated in the table below.

Fitting Size	Tube O.D.	Tube Wall	Turns required to seal from hand-tight		PSI @ 73°F (23°C)
			60C Series with soft metal tubing	60PT Series with thermoplastic tubing	
2"	1/8"	.030	1-1/4	---	400
3"	3/16"		1-1/4	---	400
4"	1/4"		1-1/4	2	300
5"	5/16"	.032	1-1/4	2	300
6"	3/8"		2-1/4	2	200
8"	1/2"		2-1/4	2	200
10"	5/8"	.035	2-1/4	2	150
12"	3/4"		2-1/4	2	100
14"	7/8"		2-1/4	---	75

### Male Connectors

#### Feature

- Reference SAE 060102 BA

Tube Size	Pipe Thread	Brass Part #
1/8"	1/8"	68C-0202
3/16"	1/8"	68C-0302
	1/4"	68C-0304
1/4"	1/8"	68C-0402
	1/4"	68C-0404
	3/8"	68C-0406
	1/2"	68C-0408
5/16"	1/8"	68C-0502
	1/4"	68C-0504
3/8"	1/8"	68C-0602
	1/4"	68C-0604
	3/8"	68C-0606
7/16"	1/2"	68C-0608
	1/4"	68C-0704
	1/4"	68C-0804
1/2"	3/8"	68C-0806
	1/2"	68C-0808
	3/8"	68C-1006
5/8"	1/2"	68C-1008
	3/4"	68C-1012
	1/2"	68C-1208
3/4"	3/4"	68C-1212
	3/4"	68C-1412



## Compression Fittings

### Female Connectors

**Feature**

- Reference SAE 060103 BA

Tube Size	Pipe Thread	Brass Part #
1/8"	1/8"	66C-0202
3/16"	1/8"	66C-0302
	1/4"	66C-0304
1/4"	1/8"	66C-0402
	1/4"	66C-0404
5/16"	1/8"	66C-0502
	1/4"	66C-0504
3/8"	1/8"	66C-0602
	1/4"	66C-0604
	3/8"	66C-0606
	1/2"	66C-0608
1/2"	1/4"	66C-0804
	3/8"	66C-0806
	1/2"	66C-0808
5/8"	1/2"	66C-1008

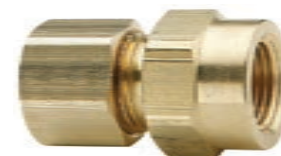

### Unions

**Feature**

- Reference SAE 060101 BA

Tube Size	Brass Part #
1/8"	62C-02
3/16"	62C-03
1/4"	62C-04
5/16"	62C-05
3/8"	62C-06
7/16"	62C-07
1/2"	62C-08
5/8"	62C-10
3/4"	62C-12
7/8"	62C-14



### Union Reducers

**Feature**

- Reference SAE 060101 BA

Tube Size	Brass Part #
1/4" x 3/16"	62C-0403
3/8" x 1/4"	62C-0604
1/2" x 3/8"	62C-0806
5/8" x 3/8"	62C-1006

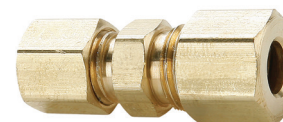

### Bulkhead Unions

Tube Size	Brass Part #
1/4"	62CBH-04
3/8"	62CBH-06

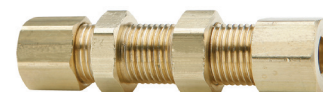

## Compression Fittings

### Straight Through Tank Fittings

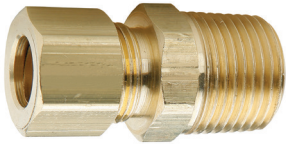

Tube Size	Pipe Thread	Brass Part #
3/16"	1/8"	682C-0302
3/8"	3/8"	682C-0606
1/2"	1/2"	682C-0808

### Female Elbows

**Feature**

- Reference SAE 060203 BA



Tube Size	Pipe Thread	Brass Part #
1/8"	1/8"	170C-0202
3/16"	1/8"	170C-0302
1/4"	1/8"	170C-0402
	1/4"	170C-0404
3/8"	1/4"	170C-0604
	3/8"	170C-0606
7/16"	1/4"	170C-0704
1/2"	3/8"	170C-0806

### Male Elbows

**Feature**

- Reference SAE 060202 BA



Tube Size	Pipe Thread	Brass Part #
1/8"	1/8"	269C-0202
3/16"	1/8"	169C-0302
	1/4"	169C-0304
1/4"	1/8"	169C-0402
	1/4"	169C-0404
	3/8"	169C-0406
5/16"	1/8"	169C-0502
	1/4"	169C-0504
	3/8"	169C-0506
3/8"	1/8"	169C-0602
	1/4"	169C-0604
	3/8"	169C-0606
	1/2"	169C-0608
1/2"	1/4"	169C-0804
	3/8"	169C-0806
	1/2"	169C-0808
5/8"	1/2"	169C-1008
3/4"	1/2"	169C-1208
	3/4"	169C-1212

### 45° Elbows



Tube Size	Pipe Thread	Brass Part #
1/4"	1/8"	179C-0402
	1/4"	179C-0404
3/8"	1/8"	179C-0602
	1/4"	179C-0604
1/2"	3/8"	179C-0606
	3/8"	179C-0806

## Compression Fittings

### Union Elbows

**Feature**

- Reference SAE 060201 BA

Tube Size	Brass Part #
1/8"	165C-02
3/16"	165C-03
1/4"	165C-04
5/16"	165C-05
3/8"	165C-06
7/16"	165C-07
1/2"	165C-08
5/8"	165C-10
3/4"	165C-12



### Male Branch Tees

**Feature**

- Reference SAE 060425 BA

Tube Size	Pipe Thread	Brass Part #
1/8"	1/8"	172C-0202
3/16"	1/8"	172C-0302
1/4"	1/8"	172C-0402
	1/4"	172C-0404
3/8"	1/8"	172C-0602
	1/4"	172C-0604
	3/8"	172C-0606
1/2"	3/8"	172C-0806



### Female Branch Tee

Tube Size	Pipe Thread	Brass Part #
1/4"	1/8"	177C-0402



### Union Tees

**Feature**

- Reference SAE 060401 BA

Tube Size 1 and 2	Tube Size 3	Brass Part #
1/8"	1/8"	164C-02
3/16"	3/16"	264C-03
1/4"	1/4"	164C-04
5/16"	5/16"	164C-05
3/8"	3/8"	164C-06
1/2"	1/2"	164C-08
5/8"	5/8"	164C-10
3/4"	3/4"	164C-12
3/8"	1/4"	164C-06-06-04
1/2"	3/8"	164C-08-08-06



## Compression Fittings

### Male Run Tees

**Feature**

- Reference SAE 060424 BA



Tube Size	Pipe Thread	Brass Part #
1/8"	1/8"	171C-0202
3/16"		171C-0302
1/4"		171C-0402
1/4"	1/4"	171C-0404
3/8"		171C-0604

### Adapter Tee



Tube Size	Male Pipe Thread	Female Straight Thread	Brass Part #
1/4"	1/8"	7/16"-24	176C-0402

### Seal Plug



Tube Size	Brass Part #
1/4"	639C-04

### Inserts



Tube Size	Tube Wall Thickness	Brass Part #	304 Stainless Steel Part #
1/8"	.016"	63PT-0216	---
	.023"	63PT-0223	---
3/16"	.025"	63PT-0325	---
	.040"	63PT-0340	---
1/4"	.040"	---	63PT-0440
	.062"	63PT-0462	---
5/16"	.040"	63PT-0540	---
	.062"	63PT-0562	---
3/8"	.062"	---	63PT-0662
1/2"	.062"	---	63PT-0862
5/8"	.062"	63PT-1062	---

NOTE: Acetal sleeves and brass inserts allow for standard compression fittings to be used with industrial grades of thermoplastic tubing.

### Brass Sleeves

**Feature**

- Reference SAE 060115



Tube Size	Brass Part #
1/8"	60C-02
3/16"	60C-03
1/4"	60C-04
5/16"	60C-05
3/8"	60C-06
7/16"	60C-07
1/2"	60C-08
5/8"	60C-10
3/4"	60C-12
7/8"	60C-14



## Compression Fittings

### Acetal Sleeves

Tube Size	Acetal Part #
1/4"	60PT-04
5/16"	60PT-05
3/8"	60PT-06
1/2"	60PT-08
5/8"	60PT-10



NOTE: Acetal sleeves and brass inserts allow for standard compression fittings to be used with industrial grades of thermoplastic tubing.

### Nuts

**Feature**

- Reference SAE 060110

Tube Size	Straight Thread	Brass Part #
1/8"	5/16"-24	61C-02
3/16"	3/8"-24	61C-03
1/4"	7/16"-24	61C-04
5/16"	1/2"-24	61C-05
3/8"	9/16"-24	61C-06
7/16"	5/8"-24	61C-07
1/2"	11/16"-20	61C-08
5/8"	13/16"-18	61C-10
3/4"	1"-18	61C-12
7/8"	1-1/8"-18	61C-14



### Long Nuts

**Feature**

- Reference SAE 060111

Tube Size	Straight Thread	Brass Part #
1/4"	7/16"-24	61CL-04
5/16"	1/2"-24	61CL-05
3/8"	9/16"-24	61CL-06
1/2"	11/16"-20	61CL-08
5/8"	13/16"-18	61CL-10
3/4"	1"-18	61CL-12



## Brass SAE 45° Flare Fittings

### Applications

- For use with copper, brass, aluminum, and welded steel hydraulic tubing that can be flared
- For use with hard-to-hold liquids and gases

### Features

- Economical fitting
- Resists mechanical pullout
- Easy to disassemble and may be reassembled repeatedly, for a leak-proof connection

### Material

- Manufactured from CA 360, CA 345, or CA377 brass

### Specification

- Temperature range: -65°F to 250°F (-54°C to 121°C)

### Approvals

- Listed with UL for flammable liquid, marine, refrigeration, and gas applications, meets functional requirements of SAE J512 and J513, ASA, and MS (Military Standards)

### Working Pressure Ranges

Temperature and type of tubing used are important factors. The following table is a general guide for proper selection. The PSI rating given is based on a temperature of 73°F (22°C) using copper tubing.

PSI	Tube O.D.	Tube Wall
1400	1/4"	.030
1000	3/8"	.032
750	1/2"	.032
650	5/8"	.035
550	3/4"	.035

### Assembly Instructions

1. Cut tubing squarely, and clean tube end thoroughly to remove burrs.
2. Place nut onto tube. Place threaded end of nut toward end of tube.
3. Flare tube end with flaring tool to provide 45° flare. (Flare tools are available. Please contact Dixon® for pricing and availability.)
4. Clamp tube flare between nut and nose of fitting body by screwing nut on finger-tight. Tighten with a wrench an additional 1/4 turn for a metal-to-metal seal.

### Male Connectors

#### Feature

- Reference SAE 010102

Tube Size	Pipe Size	Straight Thread	Hex	Brass Part #
1/4"	1/4"	7/16"-20	9/16"	48F-4-4
	3/8"		11/16"	48F-4-6
	1/2"		7/8"	48F-4-8
3/8"	1/8"	5/8"-18	5/8"	48F-6-2
	1/4"		5/8"	48F-6-4
	3/8"		11/16"	48F-6-6
	1/2"		7/8"	48F-6-8
1/2"	1/4"	3/4"-16	3/4"	48F-8-4
	3/8"		3/4"	48F-8-6
	1/2"		7/8"	48F-8-8
5/8"	3/8"	7/8"-14	7/8"	48F-10-6
3/4"	3/4"	1-1/16"-14	1-1/16"	48F-12-12



### Female Connectors

#### Feature

- Reference SAE 010103

Tube Size	Pipe Size	Straight Thread	Hex	Brass Part #
1/4"	1/4"	7/16"-20	11/16"	46F-4-4
	1/4"	5/8"-18	11/16"	46F-6-4
3/8"	3/8"	5/8"-18	13/16"	46F-6-6
	1/2"	5/8"-18	1"	46F-6-8
1/2"	1/4"	3/4"-16	3/4"	46F-8-4
	3/8"	3/4"-16	13/16"	46F-8-6
5/8"	3/8"	7/8"-14	7/8"	46F-10-6



## Brass SAE 45° Flare Fittings

### Unions

**Feature**

- Reference SAE 010101

Tube Size	Straight Thread	Hex	Brass Part #
1/4"	7/16"-20	7/16"	42F-4
3/8"	5/8"-18	5/8"	42F-6
1/2"	3/4"-16	3/4"	42F-8



### Male Elbows

**Feature**

- Reference SAE 010202

Tube Size	Pipe Size	Straight Thread	Brass Part #
1/4"	1/8"	7/16"-20	149F-4-2
	1/4"		149F-4-4
	3/8"		149F-4-6
3/8"	1/4"	5/8"-18	149F-6-4
	3/8"		149F-6-6
	1/2"		149F-6-8
1/2"	1/4"	3/4"-16	149F-8-4
	3/8"		149F-8-6
	1/2"		149F-8-8
6/8"	1/2"	7/8"-14	149F-10-8
3/4"	3/4"	1-1/16"-14	149F-12-12



### Female Elbows

**Feature**

- Reference SAE 010203

Tube Size	Pipe Size	Straight Thread	Brass Part #
1/4"	1/4"	7/16"-20	150F-4-4
3/8"	3/8"	5/8"-18	150F-6-6
	1/2"		150F-6-8



### 90° Swivel Elbows

Tube Size	Straight Thread	Brass Part #
1/4"	7/16"-20	166FSV-4-4
3/8"	5/8"-18	166FSV-6-6
1/2"	3/4"-16	166FSV-8-8



## Brass SAE 45° Flare Fittings

### 45° Elbows



**Feature**

- Reference SAE 010302

Tube Size	Pipe Size	Straight Thread	Brass Part #
1/4"	1/4"	7/16"-20	159F-4-4
3/8"	1/4"	5/8"-18	159F-6-4
	3/8"		159F-6-6
1/2"	1/4"	3/4"-16	159F-8-4
	3/8"		159F-8-6
	1/2"		159F-8-8

### Union Tees



**Feature**

- Reference SAE 010401

Tube Size	Straight Thread	Brass Part #
1/4"	7/16"-20	144F-4
3/8"	5/8"-18	144F-6
1/2"	3/4"-16	144F-8

### Short Nuts



**Application**

- Short nut for use when vibration is minimal

**Feature**

- Reference SAE 010110

Tube Size	Straight Thread	Hex	Brass Part #
1/4"	7/16"-20	9/16"	41FS-4
3/8"	5/8"-18	3/4"	41FS-6
1/2"	3/4"-16	7/8"	41FS-8

### Long Nuts



**Features**

- Long nut offers additional vibration capacity
- Reference SAE 010111

Tube Size	Straight Thread	Hex	Brass Part #
1/4"	7/16"-20	9/16"	41FL-4
3/8"	5/8"-18	3/4"	41FL-6
1/2"	3/4"-16	7/8"	41FL-8



## Flareless Bite Fittings

### Applications

- Chemical, pulp and paper, oil and gas refineries, military, air compressors, and machine tools
- Well-suited for a variety of processing and general hydraulic applications

### Features

- Ideally suited for use with tubing having medium to extra heavy wall thicknesses
- 3-piece design, with only one ferrule eliminates possible make-up errors that may occur using a twin ferrule tube fitting
- Minimal risk of improper assembly as the ferrule visibly bites into the tubing, allowing installer to visually inspect the bite quality

### Specifications

- Fittings are suitable for sub-zero through elevated temperature applications
- Temperature rating is limited by the material chosen
- Pressure ratings are determined by the size (O.D.) and wall thickness (inches/mm) of the tubing on which they are to be installed

### Approvals

- Exceeds Military (MIL F18866) and SAE J514 standards

### Assembly Instructions

- Cut, deburr, and clean tubing
- Pre-set ferrule onto tubing
- Inspect ferrule bite in tubing by disassembling the fitting and visually inspecting the deburred end of tube for slight indentation
- Finger tighten nut and then further wrench tighten nut another 1/3 to 1/2 turn

### Male Tube x Male NPTF Adapters

Tube O.D.	Male NPTF	Steel Part #
1/8"	1/8"	FLC2404-02
	1/4"	FLC2404-02-04
3/16"	1/8"	FLC2404-03-02
	1/4"	FLC2404-04-02
1/4"	1/4"	FLC2404-04
	3/8"	FLC2404-04-06
	1/2"	FLC2404-04-08
5/16"	1/8"	FLC2404-05-02
	1/4"	FLC2404-05-04
3/8"	1/8"	FLC2404-06-02
	1/4"	FLC2404-06-04
	3/8"	FLC2404-06
1/2"	1/2"	FLC2404-06-08
	1/4"	FLC2404-08-04
	3/8"	FLC2404-08-06
	1/2"	FLC2404-08
5/8"	3/4"	FLC2404-08-12
	3/8"	FLC2404-10-06
	1/2"	FLC2404-10-08
3/4"	3/4"	FLC2404-10-12
	1/2"	FLC2404-12-08
	3/4"	FLC2404-12
1"	1"	FLC2404-12-16
	3/4"	FLC2404-16-12
	1"	FLC2404-16
1-1/4"	1-1/4"	FLC2404-16-20
	3/4"	FLC2404-20-12
1-1/2"	1-1/4"	FLC2404-20
1-1/2"	1-1/2"	FLC2404-24



### Male Tube x Male 37° JIC

Tube O.D.	Male 37° JIC	Steel Part #
1/4"	1/4"	FLC2402-04-04
3/8"	3/8"	FLC2402-06-06
1/2"	1/2"	FLC2402-08-08
3/4"	3/4"	FLC2402-12-12



**Flareless Bite Fittings**

**Male Tube x Female NPTF Adapters**

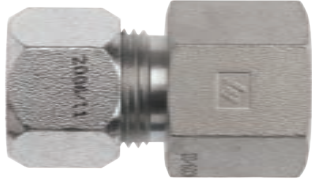

Tube O.D.	Female NPTF	Steel Part #
1/8"	1/8"	FLC2405-02
1/4"	1/8"	FLC2405-04-02
	1/4"	FLC2405-04
5/16"	1/8"	FLC2405-05-02
3/8"	1/4"	FLC2405-06-04
	3/8"	FLC2405-06
1/2"	1/4"	FLC2405-08-04
	3/8"	FLC2405-08-06
	1/2"	FLC2405-08
5/8"	1/2"	FLC2405-10-08
3/4"	3/4"	FLC2405-12
1"	1"	FLC2405-16
1-1/4"	1-1/4"	FLC2405-20

**Tube Unions**



Tube O.D.	Steel Part #
1/8"	FLC2403-02
3/16"	FLC2403-03
1/4"	FLC2403-04
5/16"	FLC2403-05
3/8"	FLC2403-06
1/2"	FLC2403-08
5/8"	FLC2403-10
3/4"	FLC2403-12
1"	FLC2403-16
1-1/4"	FLC2403-20
1-1/2"	FLC2403-24

**Male Tube x Male NPTF Adapter 90° Elbows**

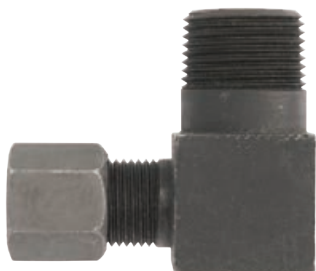

Tube O.D.	Male NPTF	Steel Part #
1/8"	1/8"	FLC2501-02
3/16"	1/8"	FLC2501-03-02
	1/8"	FLC2501-04-02
1/4"	1/4"	FLC2501-04
	3/8"	FLC2501-04-06
5/16"	1/8"	FLC2501-05-02
	1/4"	FLC2501-05-04
3/8"	1/8"	FLC2501-06-02
	1/4"	FLC2501-06-04
	3/8"	FLC2501-06
1/2"	1/2"	FLC2501-06-08
	1/4"	FLC2501-08-04
	3/8"	FLC2501-08-06
5/8"	1/2"	FLC2501-08
	3/4"	FLC2501-08-12
	3/8"	FLC2501-10-06
3/4"	1/2"	FLC2501-10-08
	3/4"	FLC2501-12-08
1"	3/4"	FLC2501-12
	1"	FLC2501-16-12
1-1/4"	1"	FLC2501-16
1-1/4"	1-1/4"	FLC2501-20
1-1/2"	1-1/2"	FLC2501-24

P

## Flareless Bite Fittings

### Male Union 90° Elbows

Tube O.D.	Steel Part #
1/4"	FLC2500-04
5/16"	FLC2500-05
3/8"	FLC2500-06
1/2"	FLC2500-08
5/8"	FLC2500-10
3/4"	FLC2500-12
1"	FLC2500-16
1-1/4"	FLC2500-20



### Male Tube Union Tees

Tube O.D.	Steel Part #
1/8"	FLC2603-02
3/16"	FLC2603-03
1/4"	FLC2603-04
5/16"	FLC2603-05
3/8"	FLC2603-06
1/2"	FLC2603-08
5/8"	FLC2603-10
3/4"	FLC2603-12
1"	FLC2603-16
1-1/4"	FLC2603-20

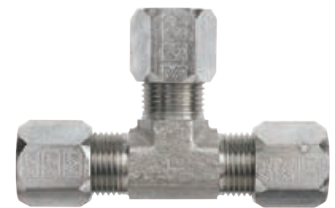

### Ferrules

Tube O.D.	Steel Part #
1/8"	FLC0319-02
3/16"	FLC0319-03
1/4"	FLC0319-04
5/16"	FLC0319-05
3/8"	FLC0319-06
1/2"	FLC0319-08
5/8"	FLC0319-10
3/4"	FLC0319-12
1"	FLC0319-16
1-1/4"	FLC0319-20
1-1/2"	FLC0319-24



### Nuts

Tube O.D.	Steel Part #
1/8"	FLC0318-02
3/16"	FLC0318-03
1/4"	FLC0318-04
5/16"	FLC0318-05
3/8"	FLC0318-06
1/2"	FLC0318-08
5/8"	FLC0318-10
3/4"	FLC0318-12
1"	FLC0318-16
1-1/4"	FLC0318-20
1-1/2"	FLC0318-24



**Tectite™ by Apollo® Push to Connect Fittings**

**Applications**

- For water, dry, clean air, or 100% glycol solutions only
- Connects copper, CPVC, and PEX pipe in any combination
- Approved for use underground and behind walls without access panels



**Features**

- No soldering, clamps, unions, or glue needed
- Integral tube liner for PEX installations
- Fittings can be rotated after assembly for easier installation in tight spaces
- Easy to disconnect if needed
- All Tectite™ by Apollo® fittings are lead-free

**Specification**

- Pressure rating: 200 PSI at 200°F (93°C)

**Approvals**

- Design certified and listed to ASSE 1061/NSF 61
- Listed by IAPMO
- Meets UPC, IPC, and cUPC requirements

**Straight Couplings**



Tube Size	Forged Brass Part #
1/2" x 1/2"	U008
3/4" x 3/4"	U016
1" x 1"	U020

**Reducing Couplings**



Tube Size	Forged Brass Part #
3/4" x 1/2"	U058
1" x 3/4"	U060

**Straight Connectors**



Tube Size	Female NPT	Forged Brass Part #
1/2"	1/2"	U072
3/4"	3/4"	U088
1"	1"	U094

P



Tube Size	Male NPT	Forged Brass Part #
1/2"	1/2"	U120
3/4"	3/4"	U134
1"	1"	U140

**Reducing Connectors**



Tube Size	Female NPT	Forged Brass Part #
1/2"	3/4"	U068



Tube Size	Male NPT	Forged Brass Part #
1/2"	3/4"	U116



## Tectite™ by Apollo® Push to Connect Fittings

### Elbows

Tube Size	Forged Brass Part #
1/2" x 1/2"	U248
3/4" x 3/4"	U256
1" x 1"	U260



### Drop Ear Elbow

Tube Size	Female NPT	Forged Brass Part #
1/2"	1/2"	U334



### Tees

Tube Size	Forged Brass Part #
1/2"	U362
3/4"	U370



### Reducing Tee

Tube Size (2)	Tube Size	Forged Brass Part #
3/4"	1/2"	U412



### End Stops

Tube Size	Forged Brass Part #
1/2"	U514
3/4"	U518
1"	U520



### Slip Couplings

**Application**

- For use with copper pipe only



Tube Size	Forged Brass Part #
1/2"	U3008
3/4"	U3016



### Disconnect Clips

Size	ABS Plastic Part #
1/2"	U710
3/4"	U712
1"	U714



## LIQUIfit™ Fittings

### Applications

- Suitable for water, potable liquids, and neutral gas applications: including water filtration, water coolers, coffee machines, and beverage dispensers

### Features

- EPDM seal secures connection with larger surface area than standard O-rings
- Engineered polymer allows superior mechanical strength and chemical resistance
- Full stainless gripping ring eliminates the need for locking clips
- Release button protects and supports tubing

### Approvals

- FDA compliant
- Meets California and Vermont <0.25% lead requirements
- NSF-51 listed for contact with food
- NSF-61 list C-Hot rated



### Specifications

- Working pressure:
  - 1/4" 230 PSI from 35°F to 100°F (1.7°C to 38°C)  
150 PSI at 150°F (66°C)  
60 PSI at 200°F (93°C)
  - 3/8" 190 PSI from 35°F to 100°F (1.7°C to 38°C)  
100 PSI at 150°F (66°C)  
60 PSI at 200°F (93°C)
  - 1/2" 160 PSI from 35°F to 100°F (1.7°C to 38°C)  
100 PSI at 150°F (66°C)  
60 PSI at 200°F (93°C)
- Maximum torque values for NPTF threads:
  - 1/8" and 1/4" 1.0 ft. lbs. / 1.5Nm
  - 3/8" and 1/2" 2.2 ft. lbs. / 3.0Nm

### Male Connectors



Tube O.D.	Male NPTF	Nylon Part #	Pkg Qty
1/4"	1/8"	65055611WP2	10
	1/4"	65055614WP2	10
3/8"	1/4"	65056014WP2	10
	3/8"	65056018WP2	10
1/2"	3/8"	65056218WP2	5
	1/2"	65056222WP2	5

### Female Connectors



Tube O.D.	Female NPTF	Nylon Part #	Pkg Qty
1/4"	1/4"	63155614WP2	10
3/8"	3/8"	63156018WP2	10

### Faucet Connectors



Tube O.D.	Female UNS	Nylon Part #	Pkg Qty
1/4"	7/16"-24	632556133WP2	10
3/8"		632560133WP2	10

### Fixed Elbows



Tube O.D.	Male NPTF	Nylon Part #	Pkg Qty
1/4"	1/8"	65795611WP2	10
	1/4"	65795614WP2	10
	3/8"	65795618WP2	10
3/8"	1/4"	65796014WP2	10
	3/8"	65796018WP2	10

P

### LIQUIfit™ Fittings

#### Union Elbows

Tube O.D.	Nylon Part #	Pkg Qty
1/4"	63025600WP2	10
3/8"	63026000WP2	10
1/2"	63026200WP2	5



#### Union Tees

Tube O.D.	Nylon Part #	Pkg Qty
1/4"	63045600WP2	10
3/8"	63046000WP2	10
1/2"	63046200WP2	5



#### Union Connectors

Tube O.D. (1)	Tube O.D. (2)	Nylon Part #	Pkg Qty
1/4"	1/4"	63065600WP2	10
	3/8"	63065660WP2	10
3/8"	3/8"	63066000WP2	10
	1/2"	63066062WP2	5
1/2"	1/2"	63066200WP2	5



#### Unequal Union Tee

Branch Tube O.D. (1)	Run Tube O.D. (2)	Nylon Part #	Pkg Qty
1/4"	3/8"	63046056WP2	10



#### Bulkhead Unions

Tube O.D.	Nylon Part #	Pkg Qty
1/4"	63165600WP2	10
3/8"	63166000WP2	10
1/2"	63166200WP2	5



#### Union Y Connectors

Tube O.D.	Nylon Part #	Pkg Qty
1/4"	63405600WP2	10
3/8"	63406000WP2	10
1/2"	63406200WP2	5



**LIQUIfit™ Fittings**

**Swivel Elbows**



Tube O.D.	Male NPTF	Nylon Part #	Pkg Qty
1/4"	1/8"	65095611WP2	10
	1/4"	65095614WP2	10
	3/8"	65095618WP2	10
3/8"	1/4"	65096014WP2	10
	3/8"	65096018WP2	10
1/2"	3/8"	65096218WP2	4
	1/2"	65096222WP2	4

**Swivel Branch Tees**



Tube O.D.	Male NPTF	Nylon Part #	Pkg Qty
1/4"	1/8"	65085611WP2	10
	1/4"	65085614WP2	10
	3/8"	65085618WP2	10
3/8"	1/4"	65086014WP2	10
	3/8"	65086018WP2	10

**Swivel Male Run Tees**



Tube O.D.	Male NPTF	Nylon Part #	Pkg Qty
1/4"	1/8"	65035611WP2	10
	1/4"	65035614WP2	10
	3/8"	65035618WP2	10
3/8"	1/4"	65036014WP2	10
	3/8"	65036018WP2	10

**Stem Adapters**



Tube O.D.	Male NPTF	Nylon Part #	Pkg Qty
1/4"	1/4"	65215614WP2	10
	3/8"	65215618WP2	10
3/8"	1/4"	65216014WP2	10
	3/8"	65216018WP2	10
1/2"	3/8"	65216218WP2	5
	1/2"	65216222WP2	5

**End Stops**



Tube O.D.	Nylon Part #	Pkg Qty
1/4"	63515600WP2	10
3/8"	63516000WP2	10

**Plugs**



Tube O.D.	Nylon Part #	Pkg Qty
1/4"	63265600WP2	10
3/8"	63266000WP2	10
1/2"	63266200WP2	5

P

## LIQUIfit™ Fittings

### Hose Stems

Tube O.D.	Stem	Nylon Part #	Pkg Qty
1/4"	1/4"	63225656WP2	10
3/8"	1/4"	63226056WP2	10
	5/16"	63226008WP2	10
	3/8"	63226060WP2	10
1/2"	3/8"	63226260WP2	10



### Plug-in Reducers

Tube O.D.	Plug-in	Nylon Part #	Pkg Qty
1/4"	5/16"	63665608WP2	10
1/4"	3/8"	63665660WP2	10
3/8"	1/2"	63666062WP2	5



### Plug-in Elbows

Tube O.D.	Plug-in	Nylon Part #	Pkg Qty
1/4"	1/4"	63825600WP2	10
3/8"	3/8"	63826000WP2	10
1/2"	1/2"	63826200WP2	5



### Plug-in Tees

Tube O.D.	Plug-in	Nylon Part #	Pkg Qty
1/4"	1/4"	63885600WP2	10
3/8"	3/8"	63886000WP2	10
1/2"	1/2"	63886200WP2	5



## TrueSeal™ Ball Valves

### Applications

- These corrosion-resistant, all-plastic designed ball valves are ideal for water filtration units, coffee and beverage machines, and a wide variety of other fluid applications

### Features

- EPDM seal secures connection with larger surface area than standard O-rings
- Full flow self-cleaning ball
- Bi-directional flow maximizes productivity

### Materials

- O-ring seal material: EPDM
- High-temperature, scale-resistant Polysulfone ball
- Glass-reinforced Polypropylene body

### Specifications

- Temperature range: **35°F to 200°F (2°C to 93°C)**
- Maximum operating pressure: **150 PSI**
- Burst pressure **600 PSI**
- Actual working pressures will be lower at elevated temperatures

### Approvals

- FDA compliant
- NSF/ANSI-51 listed for contact with food
- Certified to NSF/ANSI-61



### Tube to Male NPTF

Tube O.D.	Male NPTF	Polypropylene Part #	Pkg Qty
1/4"	1/4"	PP4VMC4-MG	10
	3/8"	PP4VMC6-MG	10
3/8"	1/4"	PP6VMC4-MG	10
	3/8"	PP6VMC6-MG	10



### Tube to Female NPTF

Tube O.D.	Female NPTF	Polypropylene Part #	Pkg Qty
1/4"	1/8"	PP4VFC2-MG	10
	1/4"	PP4VFC4-MG	10
	3/8"	PP4VFC6-MG	10
3/8"	1/8"	PP6VFC2-MG	10
	1/4"	PP6VFC4-MG	10
	3/8"	PP6VFC6-MG	10

### Tube to Male NPTF Elbows

Tube O.D.	Male NPTF	Polypropylene Part #	Pkg Qty
1/4"	1/4"	PP4VME4-MG	10
	3/8"	PP4VME6-MG	10
	1/2"	PP4VME8-MG	10
3/8"	1/4"	PP6VME4-MG	10
	3/8"	PP6VME6-MG	10
	1/2"	PP6VME8-MG	10



### Tube to Female NPTF Elbows

Tube O.D.	Female NPTF	Polypropylene Part #	Pkg Qty
1/4"	1/4"	PP4VFE4-MG	10
	3/8"	PP4VFE6-MG	10
3/8"	1/4"	PP6VFE4-MG	10
	3/8"	PP6VFE6-MG	10



## TrueSeal™ Ball Valves

### Tube to Tube Unions

Tube O.D. 1	Tube O.D. 2	Polypropylene Part #	Pkg Qty
1/4"	1/4"	PP4VUC4-MG	10
3/8"	1/4"	PP4VUC6-MG	10
3/8"	3/8"	PP6VUC6-MG	10



### Tube to Tube Elbow Unions

Tube O.D. 1	Tube O.D. 2	Polypropylene Part #	Pkg Qty
1/4"	1/4"	PP4VEU4-MG	10
	3/8"	PP4VEU6-MG	10
3/8"	1/4"	PP6VEU4-MG	10
	3/8"	PP6VEU6-MG	10



### Tube to Plug-in Elbow Unions

Tube O.D.	Stem	Polypropylene Part #	Pkg Qty
1/4"	3/8"	PP4VTEU6-MG	10
3/8"	3/8"	PP6VTEU6-MG	10



## TrueSeal™ Check Valves

### Applications

Push-to-connect check valves ensure protection against reversal of flow. The valves have an arrow molded into the body to indicate the direction of flow. Valves are designed for connection with either thermoplastic or soft metal tubing and are intended for use with liquids only.

### Materials

- Body material: acetal
- O-ring: EPDM
- Metal grip edge: 300 stainless steel

### Specifications

- Maximum operating pressure: **150 PSI** (dependent on tubing used)
- Temperature range: **34°F to 150°F (1°C to 65°C)**
- Cracking pressure: **1/3 PSI**

### Approvals

- NSF-51 listed

Tube O.D.	Acetal Part #	Pkg Qty
1/4"	A4VC4-MG	25
3/8"	A6VC6-MG	25



## **Tubing ..... 999 - 1003**

PVC .....	999
PVC braided .....	1000
D.O.T. air brake tubing rolls .....	1000
Polyurethane .....	1001
Polyethylene .....	1001
Nylon .....	1002
Polyurethane - 95 durometer .....	1002
Fluoropolymer FEP 140 .....	1002
PVC tubing and hose cutters .....	1003

## **Plastic Fittings ..... 1004 - 1011**

Hose shank x male NPT inserts .....	1004
Tuff-Lite® .....	1004
Hose shank x male NPT insert .....	1004
Hose shank x female NPT insert .....	1005
Female 45°SAE/37°JIC swivel x hose barb .....	1005
Short shank x female NPSM coupling .....	1005
Tuff-Lite - reducing bushings .....	1005
Tuff-Lite .....	1006
90° hose barb elbow x male NPT .....	1006
90° hose barb elbow x female NPT .....	1006
Hose barb x 90° hose barb elbow .....	1006
Hose run x male NPT branch tee .....	1007
Hose run x hose branch tee .....	1007
Menders .....	1007
Short shank female GHT couplings .....	1008
Short shank male GHT couplings .....	1008
Male GHT x female NPT adapter .....	1008
Female GHT x male NPT adapter .....	1008
Female GHT x female NPT adapter .....	1009
Male GHT x male NPT adapter .....	1009
Male GHT x 90° hose barb elbow .....	1009
GHT x male NPT elbow .....	1009
Push-on hose shank x male NPT insert .....	1010
Push-on hose shank x female NPT insert .....	1010
Push-on hose menders .....	1010
Black SBR washers .....	1011
Black EPDM garden hose washers .....	1011
Red vinyl GHT washer .....	1011
White rubber GHT washer .....	1011



## PVC Tubing

### Application

- For use with standard shank fittings in low-pressure liquid and pneumatic applications

### Domestic

### Application

- For non-critical hospital use such as suction and draining

### Features

- Made from non-toxic ingredients conforming to FDA standards
- Phthalate, DEHP, and BPA free
- Shipped in individually boxed bundles, sold only in lengths shown below

### Specification

- Maximum temperature: 175°F (79°C)

### Approvals

- Finished product meets USP class VI
- NSF-51 certified
- Reach and RoHS compliant
- Raw materials meet califoria proposition 65



Size		Working Pressure PSI @ 70°F (21°C)	Length	Clear PVC Part #
O.D.	I.D.			
5/16"	3/16"	106	100'	CL0305
3/8"	1/4"	85	100'	CL0406
1/2"	1/4"	141	100'	CL0408
7/16"	5/16"	71	100'	CL0507
1/2"	3/8"	70	100'	CL0608
5/8"	3/8"	111	100'	CL0610
5/8"	1/2"	52	100'	CL0810
3/4"	1/2"	85	100'	CL0812
7/8"	5/8"	71	100'	CL1014
1"	3/4"	61	100'	CL1216
1-1/4"	1"	42	100'	CL1620
1-3/4"	1-1/4"	71	50'	CL2028-50
2"	1-1/2"	61	50'	CL2432-50

### Imported

### Feature

- Shipped in bundles wrapped with PVC film, sold only in lengths shown below

### Specification

- Temperature range: 14°F to 149°F (-10°C to 65°C)

Size		Working Pressure PSI @ 72°F (22°C)	Length	Clear PVC Part #
O.D.	I.D.			
3/8"	1/4"	50	100'	ICL0406
1/2"	3/8"	35	100'	ICL0608
5/8"	1/2"	35	100'	ICL0810
3/4"	1/2"	50	100'	ICL0812
1"	3/4"	35	100'	ICL1216
1-1/4"	1"	30	100'	ICL1620
2"	1-1/2"	15	50'	ICL2432



Q

### PVC Braided Tubing

**Application**

- For use with standard shank fittings in low-pressure liquid and pneumatic applications

**Domestic**

**Features**

- High grade tensile strength polyester yarn reinforcement
- Shipped in coils, sold only in lengths shown below



**Specification**

- Temperature range: 27°F to 150°F (-3C to 66°C)

Size		Working Pressure PSI @ 72°F (22°C)	Length	Clear PVC Part #
O.D.	I.D.			
.435	1/4"	315	300'	BR0446
.625	3/8"	265	300'	BR0609
.728	1/2"	215	300'	BR0812
.906	5/8"	200	300'	BR1014
1.024	3/4"	150	300'	BR1218
1.732	1-1/4"	110	100'	BR2027
1.950	1-1/2"	90	100'	BR2431

**Imported**

**Features**

- For various machine tools and the transportation of chemicals
- Shipped in bundles wrapped with PVC film, sold only in lengths shown below



**Specification**

- Temperature range: 14°F to 149°F (-10°C to 65°C)

Size		Working Pressure PSI @ 72°F (22°C)	Length	Clear PVC Part #
O.D.	I.D.			
1/2"	1/4"	142	300'	IBR0446
5/8"	3/8"	114	300'	IBR0609
3/4"	1/2"	100	300'	IBR0812
1-1/16"	3/4"	71	300'	IBR1218
1-5/16"	1"	71	200'	IBR1621

### D.O.T. Air Brake Tubing Rolls

**Feature**

- Tubing cutters sold on page 1003

**Specifications**

- Working pressure: 150 PSI
- Temperature range: -40°F to 200°F (-40°C to 93°C)

**Approval**

- Meets Department of Transportation FMVSS-106 nylon material conforming to SAE J844



Tube Size	Tubing Color	Length	Nylon Part #
3/16"	black	100'	J844-03-BL-100
1/4"	black	100'	J844-04-BL-100
	blue	100'	J844-04-B-100
	red	100'	J844-04-R-100
	black	100'	J844-06-BL-100
3/8"	blue	100'	J844-06-B-100
	red	100'	J844-06-R-100
	black	100'	J844-08-BL-100
5/8"	black	100'	J844-10-BL-100
3/4"	black	100'	J844-12-BL-100

Q

### Polyurethane Tubing

**Application**

- For use with the push-in fittings sold on pages 240 - 248

**Features**

- Naturally transparent
- Excellent memory, flexibility, and resistance to kinking
- Good resistance to fuels and oils
- Low gas and vapor permeability
- High compressive strength
- Low compressive set and extractability levels
- Outstanding abrasion resistance

**Specification**

- Temperature range: -40°F to 165°F (-40°C to 74°C)



Size		Wall Thickness	Working Pressure PSI @ 75°F (24°C)	Length	Polyurethane Part #
O.D.	I.D.				
1/8"	.062"	.0295"	255	250'	04063
5/32"	.094"	.0315"	210	100'	05094
1/4"	.160"	.0450"	175	100'	08160
3/8"	.245"	.0650"	170	100'	12250
1/2"	.320"	.0900"	175	50'	16320

### Polyethylene Tubing

**Application**

- For use with the push-in fittings sold on pages 240 - 248

**Features**

- Flexible, lightweight, low-density polyethylene (LLDPE) tubing
- For use with plastic or metal inserts with outer sleeve, ferrule, or clamps
- Formulated to resist stress cracking
- Glossy finish

**Specification**

- Temperature range: -50°F to 140°F (-46° to 60°C)

**Approvals**

- NSF61 certified for potable water
- UV stabilized
- Designed for FDA applications, complies with 21CFR 177.1520 (c) food contact



Size		Wall Thickness	Working Pressure PSI @ 75°F (24°C)	Length	Tubing Color	Polyethylene Part #
O.D.	I.D.					
1/4"	.125"	.062"	350	100'	natural	0804
1/4"	.170"	.040"	150	100'	natural	0817
1/4"	.170"	.040"	150	100'	blue	0817BL100
3/8"	.250"	.062"	150	100'	natural	1208
1/2"	.375"	.062"	125	100'	natural	1612

Size		Wall Thickness	Working Pressure PSI @ 75°F (24°C)	Length	Tubing Color	Polyethylene Part #
O.D.	I.D.					
1/4"	.170"	.040"	150	500'	blue	0817BL
1/4"	.170"	.040"	150	500'	black	0817BR
1/4"	.170"	.040"	150	500'	natural	0817CR
3/8"	.250"	.062"	150	500'	black	1208BR
3/8"	.250"	.062"	150	500'	natural	1208CR

### Nylon Tubing

**Application**

- For use with the push-in fittings sold on pages 240 - 248

**Features**

- Naturally transparent
- Recommended for applications requiring low density, lightweight toughness, flexibility, and chemical resistance
- Packaged in plastic bags

**Specification**

- Temperature range: -40°F to 180°F (-40°C to 82°C)

Size		Wall Thickness	Working Pressure PSI @ 75°F (24°C)	Length	Nylon Part #
O.D.	I.D.				
1/8"	.093"	.016"	270	100'	04093
5/32"	.106"	.025"	350	100'	05106
3/16"	.138"	.025"	260	100'	06138
1/4"	.170"	.040"	330	100'	08170
1/4"	.180"	.035"	290	100'	08180
3/8"	.275"	.050"	250	100'	12275
1/2"	.375"	.062"	240	100'	16375



NOTE: Tubing cutters sold on page 1003



### Nylon Tubing



**Application**

- Ideal for many industrial applications

**Features**

- Chemical, humidity, and abrasion resistant
- Semi rigid

**Specification**

- Temperature range: -65°F to 200°F (-54°C to 93°C)

Size		Wall	Working Pressure	Length	Natural Nylon	Black Nylon	Blue Nylon
O.D.	I.D.	Thickness	PSI @ 75°F (24°C)		Part #	Part #	Part #
1/8"	.093"	.016"	250	50'	1091P5300	1091P5301	1091P5304
5/32"	.106"	.025"	300	50'	1091P0400	1091P0401	1091P0404
3/16"	.138"	.025"	250	50'	1091P5500	1091P5501	---
1/4"	.170"	.040"	300	50'	1091P5600	1091P5601	1091P5604
5/16"	.233"	.040"	250	50'	1091P0800	1091P0801	1091P0804
3/8"	.275"	.050"	250	50'	1091P6000	1091P6001	1091P6004
1/2"	.375"	.062"	250	50'	1091P6200	1091P6201	1091P6204

Size		Wall	Working Pressure	Length	Natural Nylon	Black Nylon	Blue Nylon
O.D.	I.D.	Thickness	PSI @ 75°F (24°C)		Part #	Part #	Part #
1/8"	.093"	.016"	250	100'	1094P5300	1094P5301	1094P5304
5/32"	.106"	.025"	300	100'	1094P0400	1094P0401	1094P0404
3/16"	.138"	.025"	250	100'	1094P5500	1094P5501	---
1/4"	.170"	.040"	300	100'	1094P5600	1094P5601	1094P5604
5/16"	.233"	.040"	250	100'	1094P0800	1094P0801	1094P0804
3/8"	.275"	.050"	250	100'	1094P6000	1094P6001	1094P6004
1/2"	.375"	.062"	250	100'	1094P6200	1094P6201	1094P6204

### Polyurethane - 95 Durometer Tubing



**Application**

- Good for applications where space is tight; for applications where tubing will be exposed, black tubing is recommended

**Feature**

- High flexibility and a small bend radius

**Specification**

- Temperature range: -40°F to 165°F (-40°C to 74°C)

Size		Wall	Working Pressure	Length	Clear Polyurethane	Black Polyurethane	Blue Polyurethane
O.D.	I.D.	Thickness	PSI @ 75°F (24°C)		Part #	Part #	Part #
1/8"	.062"	.031"	233	50'	1091U53R00	1091U5301	1091U5304
5/32"	.093"	.031"	176	50'	1091U04R00	1091U0401	1091U0404
1/4"	.160"	.045"	148	50'	1091U56R00	1091U5601	1091U5604
5/16"	.216"	.049"	148	50'	1091U08R00	1091U0801	1091U0804
3/8"	.250"	.066"	147	50'	1091U60R00	1091U6001	1091U6004
1/2"	.320"	.090"	140	50'	1091U62R00	1091U6201	1091U6204

Size		Wall	Working Pressure	Length	Clear Polyurethane	Black Polyurethane	Blue Polyurethane
O.D.	I.D.	Thickness	PSI @ 75°F (24°C)		Part #	Part #	Part #
1/8"	.062"	.031"	233	100'	1094U53R00	1094U5301	1094U5304
5/32"	.093"	.031"	176	100'	1094U04R00	1094U0401	1094U0404
1/4"	.160"	.045"	148	100'	1094U56R00	1094U5601	1094U5604
5/16"	.216"	.049"	148	100'	1094U08R00	1094U0801	1094U0804
3/8"	.250"	.066"	147	100'	1094U60R00	1094U6001	1094U6004
1/2"	.320"	.090"	140	100'	1094U62R00	1094U6201	1094U6204

### Fluoropolymer FEP 140 Tubing

**Application**

- Provides excellent resistance to aggressive and corrosive agents and high temperatures

**Specification**

- Maximum temperature: 300°F (149°C)

**Approval**

- FDA compliant materials



Size		Wall	Working Pressure	Length	Clear Fluoropolymer Part #
O.D.	I.D.	Thickness	PSI @ 72°F (22°C)		
1/8"	.062"	.031"	500	25'	1092T5300
1/4"	.170"	.031"	165	25'	1092T5600
3/8"	.300"	.062"	249	25'	1092T6000
1/2"	.420"	.062"	165	25'	1092T6200

Q

**PVC Tubing and Hose Cutters**

**Application**

- Rugged construction cuts up to 3/4" tubing or hose

**Feature**

- Corrosion resistant hardened steel blade ensures straight, crisp cuts for optimum fit

Part #
TC97
TC97RB



**Application**

- Cuts low-pressure fabric reinforced hose up to 1" O.D.

**Feature**

- Reversible blade

Part #
HC90
HC90RB (replacement blade)



**Application**

- Cuts hose and tubing up to 1-7/8" O.D.

**Materials**

- Tough fiberglass reinforced handle
- Stainless steel blade

Part #
LHC95
LHC95RB (replacement blade)



**Hose Shank x Male NPT Inserts**

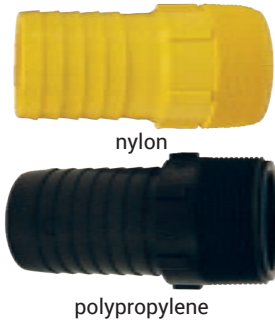

Size	Nylon Part #	Pkg Qty	Polypropylene Part #	Pkg Qty
1-1/4"	THN15	25	---	---
1-1/2"	THN20	25	HB150	25
2"	THN25	20	HB200	24
3"	THN35	10	HB300	10
4"	---	---	HB400	12

**Tuff-Lite®**

**Hose Shank x Male NPT Insert**

**Nylon Features**

- Nylon fittings should not be used with acid-based fertilizers, bromine, chlorine, fluorine, hydrochloric acid, iodine, nitric acid, phosphoric acid, sulfuric acid, or xylene
- Nylon should not be used with compressed gas 
- Fittings are white

**Polypropylene Features**

- Polypropylene fittings should not be used with aromatic hydrocarbons, carbon tetra-chloride, gasoline, hexane, kerosene, nitric acid, sodium hydrochlorite, toluene, trichloroethylene, or xylene
- Polypropylene should not be used with compressed gas 
- Fittings are black



Hose Size	Male NPT	Nylon Part #	Pkg Qty	Polypropylene Part #	Pkg Qty
1/4"	1/8"	TN21	50	PPN21	50
	1/4"	TN22	50	PPN22	50
	3/8"	TN23	50	PPN23	50
	1/2"	TN24	50	PPN24	50
	3/4"	TN26	50	---	---
	1"	TN28	50	---	---
5/16"	1/4"	TN252	50	---	---
3/8"	1/8"	TN31	50	PPN31	50
	1/4"	TN32	50	PPN32	50
	3/8"	TN33	50	PPN33	50
	1/2"	TN34	50	PPN34	50
	3/4"	TN36	50	PPN36	50
1/2"	1/8"	TN41	50	---	---
	1/4"	TN42	50	PPN42	50
	3/8"	TN43	50	PPN43	50
	1/2"	TN44	50	PPN44	50
	3/4"	TN46	50	PPN46	50
5/8"	3/8"	TN53	50	---	---
	1/2"	TN54	50	PPN54	50
	3/4"	TN56	50	PPN56	50
3/4"	3/8"	TN63	50	---	---
	1/2"	TN64	50	PPN64	50
	3/4"	TN66	50	PPN66	50
	1"	TN68	25	PPN68	25
1"	3/4"	TN86	25	PPN86	25
	1"	TN88	25	PPN88	25
1-1/4"	1"	TN158	15	---	---
	1-1/4"	TN150	10	PPN150	10
1-1/2"	1-1/2"	TN1520	10	---	---
	1-1/4"	TN2015	10	---	---
	1-1/2"	TN200	10	PPN200	10
2"	2"	TN250	5	PPN250	5

NOTE: Sold in package quantities only



**Tuff-Lite®**

**Hose Shank x Female NPT Insert**

**Features**

- Nylon fittings should not be used with acid-based fertilizers, bromine, chlorine, fluorine, hydrochloric acid, iodine, nitric acid, phosphoric acid, sulfuric acid, or xylene
- Nylon should not be used with compressed gas 

Hose Size	Female NPT	Nylon Part #
1/4"	1/4"	TFS22
1/4"	1/2"	TFS42
1/2"	1/2"	TFS44
3/4"	3/4"	TFS66



**Female 45°SAE/37° JIC Swivel x Hose Barb**

**Specification**

- Ball seat type

Hose Size	Female NPSM	Nylon Part #
1/4"	1/4"	TF22
3/8"	3/8"	TF33



**Short Shank x Female NPSM Couplings**

**Features**

- Sold in package quantities only
- Shipped with a red vinyl washer (TVW7), replacement washers on page 412

Hose Shank	Female NPSM	Nylon Part #	Pkg Qty
1/4"	3/4"	TCF62	50
3/8"	3/4"	TCF63	50
1/2"	3/4"	TCF64	50
5/8"	3/4"	TCF65	50
3/4"	3/4"	TCF66	50



**Tuff-Lite - Reducing Bushings**

Male NPT	Female NPT	Nylon Part #
3/8"	1/4"	THB32
1/2"	1/4"	THB42
1/2"	3/8"	THB43
3/4"	1/2"	THB64
1"	3/4"	THB86



NOTE: For additional information on pipe dimensions please reference [dixonvalve.com](http://dixonvalve.com).



**Tuff-Lite®**

**90° Hose Barb Elbow x Male NPT**



Hose Size	Male NPT	Nylon Part #	Pkg Qty
1/4"	1/8"	TLS21	50
	1/4"	TLS22	50
	3/8"	TLS23	50
3/8"	1/8"	TLS31	50
	1/4"	TLS32	50
	3/8"	TLS33	50
	1/2"	TLS34	50
	3/4"	TLS36	50
1/2"	1/4"	TLS42	50
	3/8"	TLS43	50
	1/2"	TLS44	50
	3/4"	TLS46	25
5/8"	1"	TLS48	25
	3/8"	TLS53	25
	1/2"	TLS54	25
	3/4"	TLS56	25
3/4"	1"	TLS58	25
	3/8"	TLS63	25
	1/2"	TLS64	25
	3/4"	TLS66	25
1"	1"	TLS68	15
	3/4"	TLS86	15
	1"	TLS88	15

NOTE: Sold in package quantities only.



**90° Hose Barb Elbow x Female NPT**

Hose Size	Female NPT	Nylon Part #
1/2"	1/2"	TLFS44
1/2"	3/4"	TLFS64
3/4"	3/4"	TLFS66

**Hose Barb x 90° Hose Barb Elbow**

Q



nylon

polypropylene

Hose Size	Nylon Part #	Pkg Qty	Polypropylene Part #	Pkg Qty
1/4"	TLSS22	50	PPLSS22	50
3/8"	TLSS33	50	PPLSS33	50
1/2"	TLSS44	50	PPLSS44	50
3/4"	TLSS66	50	PPLSS66	50

NOTE: Sold in package quantities only.



**Tuff-Lite®**

**Hose Run x Male NPT Branch Tees**

Hose Size	Male NPT	Nylon Part #	Pkg Qty
1/4"	1/4"	TSST222	50
3/8"	3/8"	TSST333	50
1/2"	1/2"	TSST444	25
3/4"	3/4"	TSST666	25

NOTE: Sold in package quantities only



**Hose Run x Hose Branch Tees**

Hose Size	Nylon Part #	Pkg Qty
1/4"	TSSS222	50
3/8"	TSSS333	50
1/2"	TSSS444	50
3/4"	TSSS666	25

NOTE: Sold in package quantities only



**Menders**

**Specification**

- Maximum working temperature: 150°F (66°C)

Size	Nylon Part #	Pkg Qty	Polypropylene Part #	Pkg Qty
1/4"	TM2 <sup>1</sup>	50	PPM2	50
5/16"	TM25 <sup>1</sup>	50	---	---
3/8"	TM3 <sup>1</sup>	50	PPM3	50
1/2"	TM4 <sup>1</sup>	50	PPM4	50
5/8"	TM5 <sup>1</sup>	50	PPM5	50
3/4"	TM6 <sup>1</sup>	50	PPM6	50
1"	TM8 <sup>1</sup>	25	PPM8	50
1-1/4"	TM16	50	---	---
1-1/2"	TM21	10	---	---
2"	TM26	20	---	---
4"	TM46	25	---	---
6"	TM66	12	---	---

NOTE: Sold in package quantities only



nylon



polypropylene



**Tuff-Lite®**

**Short Shank Female GHT Couplings**



polypropylene



nylon

**Feature**

- Shipped with a red vinyl washer (TVW7), replacement washers on page 412

Hose Shank	Thread Size	Nylon Part #	Polypropylene Part #
1/4"	3/4" GHT	TCF72	PPCF72
3/8"		TCF73	PPCF73
1/2"		TCF74	PPCF74
5/8"		TCF75	PPCF75
3/4"		TCF76	PPCF76

**Short Shank Male GHT Couplings**



polypropylene



nylon

Hose Shank	Thread Size	Nylon Part #	Polypropylene Part #
1/4"	3/4" GHT	TCM72	---
3/8"		TCM73	PPCM73
1/2"		TCM74	PPCM74
5/8"		TCM75	PPCM75
3/4"		TCM76	PPCM76

**Male GHT x Female NPT Adapters**



polypropylene



nylon

Female NPT	Nylon Part #	Pkg Qty	Polypropylene Part #	Pkg Qty
1/4"	TA792	50	PPA792	50
3/8"	TA793	50	---	--
1/2"	TA794	50	PPA794	50
3/4"	TA796	50	PPA796	25

NOTE: Sold in package quantities only

**Female GHT x Male NPT Adapters**



Male NPT	Nylon Part #	Pkg Qty
1/4"	TA972	50
3/8"	TA973	50
1/2"	TA974	50
3/4"	TA976	50

NOTE: Sold in package quantities only

Q

**Tuff-Lite®**

**Female GHT x Female NPT Adapters**

Female NPT	Nylon Part #	Pkg Qty
1/2"	TA974F	50
3/4"	TA976F	50



NOTE: Sold in package quantities only

**Male GHT x Male NPT Adapters**

Male NPT	Nylon Part #	Pkg Qty	Polypropylene Part #	Pkg Qty
1/4"	TA772	50	---	---
3/8"	TA773	50	PPA773	50
1/2"	TA774	50	PPA774	50
3/4"	TA776	50	PPA776	50
1"	TA778	25	---	---



polypropylene



nylon

NOTE: Sold in package quantities only

**Male GHT x 90° Hose Barb Elbows**

Hose Size	Nylon Part #	Pkg Qty
3/8"	TLS37	50
1/2"	TLS47	25
5/8"	TLS57	25
3/4"	TLS67	50



NOTE: Sold in package quantities only

**GHT x Male NPT Elbows**

Male NPT	Nylon Part #	Pkg Qty
3/8"	TLT73	25
1/2"	TLT74	25
3/4"	TLT76	25



NOTE: Sold in package quantities only



**Tuff-Lite®**

**Push-On Hose Shank x Male NPT Inserts**

**Feature**

- No clamps are needed when these fittings are used with push-on hose



Hose Size	Male NPT	Nylon Part #	Pkg Qty
1/4"	1/8"	TPN21	50
	1/4"	TPN22	50
	3/8"	TPN23	50
3/8"	1/4"	TPN32	50
	3/8"	TPN33	50
	1/2"	TPN34	50
1/2"	3/8"	TPN43	50
	1/2"	TPN44	50
	3/4"	TPN46	50

NOTE: Sold in package quantities only

**Push-On Hose Shank x Female NPT Inserts**

**Feature**

- No clamps are needed when these fittings are used with push-on hose



Hose Size	Female NPT	Nylon Part #	Pkg Qty
1/4"	1/4"	TPF22	50
3/8"	1/4"	TPF32	50
	3/8"	TPF33	50
1/2"	3/8"	TPF43	50
	1/2"	TPF44	50

NOTE: Sold in package quantities only

**Push-On Hose Menders**

**Feature**

- No clamps needed when used with push-on hose



Size	Nylon Part #	Pkg Qty
1/4"	TPM2	50
3/8"	TPM3	50
1/2"	TPM4	50

NOTE: Sold in package quantities only



### Black SBR Washers

I.D.	O.D.	Duro	Part #	Optional Qty
0.63"	1.00"	80	5911212W	100
0.86"	1.27"	60	5911616W	100



### Black EPDM Garden Hose Washers

**Approval**

- NSF®61 approved

I.D.	O.D.	Duro	Part #
0.63"	1.00"	70	5911212WEPDM
0.86"	1.27"	70	5911616WEPDM

### Red Vinyl GHT Washer

Red Vinyl Part #	Optional Qty
TVW7	100



### White Rubber GHT Washer

White Rubber (Styrene Butadiene) Part #	Optional Qty
TRW7	100



## **Nominal ..... 1013 - 1015**

Smooth bore PTFE hose.....	1013
Smooth bore PTFE hose per foot length .....	1013
Female JIC swivels .....	1014
Rigid male pipe fittings.....	1014
Female SAE swivels.....	1014
PTFE hose insertion tool and dies .....	1015
Smooth bore PTFE hose fittings .....	1015
Tube end stubs.....	1015
45° FJIC fittings.....	1015
90° FJIC fittings.....	1015

## **True I.D. Hose ..... 1016**

True I.D. open pitch convoluted hose .....	1016
Heavy wall true I.D. smooth bore hose .....	1016

## **True I.D. Fittings..... 1016 - 1017**

Female JIC swivels .....	1016
Rigid male pipe fittings.....	1016
PTFE hose fittings.....	1017
Sanitary tri-clamps.....	1017
Mini sanitary tri-clamps.....	1017
Flange retainers.....	1017

## **Crimp Collars ..... 1017**

Convoluted .....	1017
Smooth bore .....	1017

## **Spring Guard ..... 1018**

With tang .....	1018
Without tang.....	1018

## **Continuous Spring Guard ..... 1018**

## **GSM Ball-Joint Armored Hose Assemblies ..... 1018**

## Nominal

### Application

- Suitable for conveying chemicals, foods, pharmaceuticals, oils, gas, fuels, and steam

### Size

- Size range: dash-3 to dash-20

### Features

- 304 stainless braided
- Extruded or heat shrink coverings are available upon request
- Boxed coils (bulk, per ft. lengths, and full reels available from Maryland and Texas; call Dixon® at 888.226.4673)
- For use with nominal PTFE fittings on page 1014 and 1015

### Specification

- Temperature range: -100°F to 450°F (-73°C to 232°C)

### Approval

- Nominal standard smooth bore PTFE hose meets SAE100R14

### Nominal Smooth Bore PTFE Hose (fittings not included)



Nominal Size	Average I.D.	Length in Feet	Dash Size	Working Pressure (PSI)	Burst Pressure (PSI)	White, non-conductive Part #	Black, conductive Part #
3/16"	.125"	100'	dash-3	3000	12000	---	BSB-03-100
1/4"	.187"	100'	dash-4	3000	12000	WSB-04-100	BSB-04-100
5/16"	.250"	100'	dash-5	3000	12000	WSB-05-100	BSB-05-100
3/8"	.312"	100'	dash-6	2500	10000	WSB-06-100	BSB-06-100
3/8T"	.375"	100'	dash-6T	2250	9000	WSB-06T-100	BSB-06T-100
1/2"	.405"	100'	dash-8	2000	8000	WSB-08-100	BSB-08-100
5/8"	.500"	100'	dash-10	1750	7000	WSB-10-100	BSB-10-100
3/4"	.625"	100'	dash-12	1500	6000	WSB-12-100	BSB-12-100
3/4T"	.750"	50'	dash-12T	1100	4400	WSB-12T-50	BSB-12T-50
1"	.875"	50'	dash-16	1000	4000	WSB-16-50	BSB-16-50

### Nominal Smooth Bore PTFE Hose Per Foot Length (fittings not included)

Nominal Size	Average I.D.	Dash Size	White, non-conductive Part #	Black, conductive Part #
3/16"	.125"	dash-3	WSB-03	BSB-03
1/4"	.187"	dash-4	WSB-04	BSB-04
5/16"	.250"	dash-5	WSB-05	BSB-05
3/8"	.312"	dash-6	WSB-06	BSB-06
3/8T"	.375"	dash-6T	WSB-06T	BSB-06T
1/2"	.405"	dash-8	WSB-08	BSB-08
5/8"	.500"	dash-10	WSB-10	BSB-10
3/4"	.625"	dash-12	WSB-12	BSB-12
3/4T"	.750"	dash-12T	WSB-12T	BSB-12T
1"	.875"	dash-16	WSB-16	BSB-16
1T"	1.000"	dash-16T	WSB-16T	BSB-16T
1-1/4"	1.125"	dash-20Z	WSB-20Z <sup>1</sup>	BSB-20Z <sup>1</sup>

<sup>1</sup> Double braided

NOTE: Per feet lengths are available from Maryland and Texas only. Call Dixon at 888.226.4673

### Nominal Fittings

**Crimp Collars for all nominal fittings are included**

- For use with nominal smooth bore PTFE hoses on the previous pages

#### Female JIC Swivels

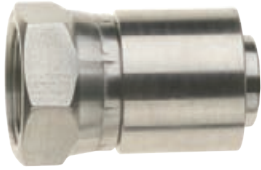

Hose Size	Thread Size	Carbon Steel Part #	304 Stainless Steel Part #	Brass Part #
dash 4	1/4"	FJC-04-04	FJS-04-04	FJB-04-04
dash 5	5/16"	FJC-05-05	FJS-05-05	FJB-05-05
dash 6	3/8"	FJC-06-06	FJS-06-06	FJB-06-06
dash 8	1/2"	FJC-08-08	FJS-08-08	FJB-08-08
dash 10	5/8"	FJC-10-10	FJS-10-10	FJB-10-10
dash 12	3/4"	FJC-12-12	FJS-12-12	FJB-12-12
dash 16	1"	FJC-16-16	FJS-16-16	FJB-16-16
dash 20Z	1-1/4"	FJC-20Z-20	FJS-20Z-20	FJB-20Z-20

#### Rigid Male Pipe Fittings

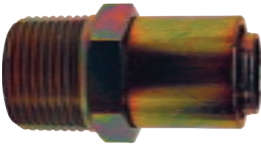

Hose Size	Thread Size	Carbon Steel Part #	304 Stainless Steel Part #	Brass Part #
dash 4	1/8"	MPC-04-02	MPS-04-02	MPB-04-02
dash 4	1/4"	MPC-04-04	MPS-04-04	MPB-04-04
dash 5	1/4"	MPC-05-04	MPS-05-04	MPB-05-04
dash 6	1/4"	MPC-06-04	MPS-06-04	MPB-06-04
dash 6	3/8"	MPC-06-06	MPS-06-06	MPB-06-06
dash 8	3/8"	MPC-08-06	MPS-08-06	MPB-08-06
dash 8	1/2"	MPC-08-08	MPS-08-08	MPB-08-08
dash 10	1/2"	MPC-10-08	MPS-10-08	MPB-10-08
dash 12	3/4"	MPC-12-12	MPS-12-12	MPB-12-12
dash 16	1"	MPC-16-16	MPS-16-16	MPB-16-16
dash 20Z	1-1/4"	MPC-20Z-20	MPS-20Z-20	MPB-20Z-20

#### Female SAE Swivels



Hose Size	Thread Size	Carbon Steel Part #	Brass Part #
dash 6	3/8"	SAEC-06-06	SAEB-06-06
dash 12	3/4"	SAEC-12-12	SAEB-12-12



## Nominal PTFE Hose Insertion Tool and Dies

### Feature

- Takes the hassle out of installing crimp collars onto braided PTFE Hose; with a few simple steps even challenging braid can be easily and safely inserted into the crimp collar

Description	Size	Part #
tool / die holder	---	ITDH
die	dash 4	ITD-04
die	dash 5	ITD-05
die	dash 6	ITD-06
die	dash 8	ITD-08
die	dash 10	ITD-10
die	dash 12	ITD-12
die	dash 16	ITD-16



## Nominal Smooth Bore PTFE Hose Fittings

Crimp collars for all nominal fittings are included

### Application

- For use with nominal smooth bore PTFE hoses on page 1013

### Tube End Stubs

Hose Size	Tube Size	304 Stainless Steel Part #
dash 4	1/4"	TES-04-04
dash 6	3/8"	TES-06-06
dash 8	1/2"	TES-08-08
dash 12	3/4"	TES-12-12
dash 16	1"	TES-16-16



### 45° FJIC Fittings

Hose Size	Thread Size	304 Stainless Steel Part #	Carbon Steel Part #
dash 3	3/16"	FJS45-03-03	FJC45-03-03
dash 4	1/4"	FJS45-04-04	FJC45-04-04
dash 5	5/16"	FJS45-05-05	FJC45-05-05
dash 6	3/8"	FJS45-06-06	FJC45-06-06
dash 8	1/2"	FJS45-08-08	FJC45-08-08
dash 10	5/8"	FJS45-10-10	FJC45-10-10
dash 12	3/4"	FJS45-12-12	FJC45-12-12
dash 16	1"	FJS45-16-16	FJC45-16-16
dash 20Z	1-1/4"	FJS45-20Z-20	FJC45-20Z-20



### 90° FJIC Fittings

Hose Size	Thread Size	304 Stainless Steel Part #	Carbon Steel Part #
dash 3	3/16"	FJS90-03-03	FJC90-03-03
dash 4	1/4"	FJS90-04-04	FJC90-04-04
dash 5	5/16"	FJS90-05-05	FJC90-05-05
dash 6	3/8"	FJS90-06-06	FJC90-06-06
dash 8	1/2"	FJS90-08-08	FJC90-08-08
dash 10	5/8"	FJS90-10-10	FJC90-10-10
dash 12	3/4"	FJS90-12-12	FJC90-12-12
dash 16	1"	FJS90-16-16	FJC90-16-16
dash 20Z	1-1/4"	FJS90-20Z-20	FJC90-20Z-20

**R**

### True I.D. Hose

**Application**

- Suitable for conveying acids, chemicals, foods, and pharmaceuticals

**Size**

- Size range: 1/4" to 2"

**Specification**

- Temperature range: -100°F to 450°F (-73°C to 232°C)

**Features**

- Boxed coils (bulk, per ft. lengths, and full reels available from Maryland and Texas, call Dixon® at 888.226.4673)
- 304 stainless braided
- Other braids including synthetic, extruded, and heat shrink coverings are available upon request

**True I.D. Open Pitch Convoluted Hose**

(fittings not included)

Size	Working Pressure PSI	Burst Pressure PSI	White, non-conductive Part #	Black, conductive Part #
1/4"	1740	6960	WOC-T04	BOC-T04
3/8"	1850	7400	WOC-T06	BOC-T06
1/2"	1500	6000	WOC-T08	BOC-T08
3/4"	1300	5200	WOC-T12	BOC-T12
1"	1000	4000	WOC-T16	BOC-T16
1-1/4"	900	3600	WOC-T20	BOC-T20
1-1/2"	700	2800	WOC-T24	BOC-T24
2"	500	2000	WOC-T32	BOC-T32

**Heavy Wall True I.D. Smooth Bore Hose**

(fittings not included)

Size	Working Pressure PSI	Burst Pressure PSI	White, non-conductive Part #	Black, conductive Part #
1/4"	3000	12000	WTB-T04	BTB-T04
3/8"	2250	9000	WTB-T06	BTB-T06
1/2"	1500	6000	WTB-T08	BTB-T08
3/4"	1100	4400	WTB-T12	BTB-T12
1"	900	3600	WTB-T16	BTB-T16
1"	1650	6600	WTB-T16Z	BTB-T16Z
1-1/4"	1000	4000	WTB-T20Z	BTB-T20Z
1-1/2"	1100	4000	WTB-T24Z	---

NOTE: For use with PTFE fittings on pages 1016 - 1017

### True I.D. Fittings

Crimp collars for all True I.D. fittings are sold separately

**Female JIC Swivels**

Size	Carbon Steel Part #	316 Stainless Steel Part #
1/4"	FJC-T04	FJR-T04
3/8"	FJC-T06	FJR-T06
1/2"	FJC-T08	FJR-T08
3/4"	FJC-T12	FJR-T12
1"	FJC-T16	FJR-T16
1-1/4"	FJC-T20	FJR-T20
1-1/2"	FJC-T24	FJR-T24
2"	FJC-T32	FJR-T32

**Rigid Male Pipe Fittings**

Size	Carbon Steel Part #	316 Stainless Steel Part #
1/4"	MPC-T04	MPR-T04
3/8"	MPC-T06	MPR-T06
1/2"	MPC-T08	MPR-T08
3/4"	MPC-T12	MPR-T12
1"	MPC-T16	MPR-T16
1-1/4"	MPC-T20	MPR-T20
1-1/2"	MPC-T24	MPR-T24
2"	MPC-T32	MPR-T32

NOTE: Four use with True I.D. PTFE hoses

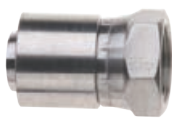
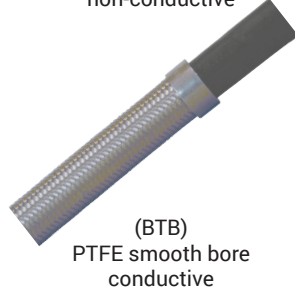
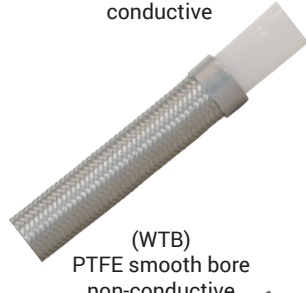
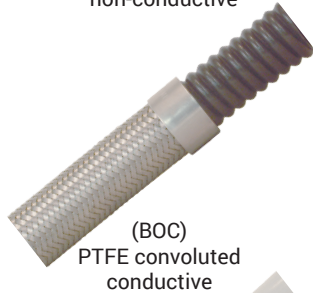

### True I.D. Fittings

#### PTFE Hose Fittings

#### Sanitary Tri-Clamps

#### Application

- For use with True I.D. PTFE hoses on page 1016

Hose Size	Clamp Size	316 Stainless Steel Part #
1/2"	1"	TCR-T08-16
1/2"	1-1/2"	TCR-T08-24
3/4"	1-1/2"	TCR-T12-24
1"	1"	TCR-T16-16
1"	1-1/2"	TCR-T16-24
1-1/2"	1-1/2"	TCR-T24-24
2"	2"	TCR-T32-32

#### Mini Sanitary Tri-Clamps

Size	316 Stainless Steel Part #
1/2"	TCMR-T08
3/4"	TCMR-T12

NOTE: Contact Dixon® at 888.226.4673 for GSM and PTFE hose assemblies

#### Flange Retainers

#### Feature

- For use with lap joint flanges. See pages 955 - 956

Size	316 Stainless Steel Part #	316 Stainless Steel PTFE Encapsulated Part #
1/2"	FRR-T08	---
3/4"	FRR-T12	FRRE-T12
1"	FRR-T16	FRRE-T16
1-1/4"	FRR-T20	FRRE-T20
1-1/2"	FRR-T24	FRRE-T24
2"	FRR-T32	FRRE-T32

#### Crimp Collars

#### Convuluted Crimp Collars

#### Features

- For True I.D. open pitch convuluted PTFE hose only
- New design for ease of installation and improved appearance of finished crimp

Size	Carbon Steel Part #	304 Stainless Steel Part #
1/4"	CSC-T04-1	SSC-T04-1
3/8"	CSC-T06-1	SSC-T06-1
1/2"	CSC-T08-1	SSC-T08-1
3/4"	CSC-T12-1	SSC-T12-1
1"	CSC-T16-1	SSC-T16-1
1-1/4"	CSC-T20-1	SSC-T20-1
1-1/2"	CSC-T24-1	SSC-T24-1
2"	CSC-T32-1	SSC-T32-1

#### Smooth Bore Crimp Collars

#### Features

- For True I.D. smooth bore PTFE hose only
- New design for ease of installation and improved appearance of finished crimp

Size	Carbon Steel Part #	304 Stainless Steel Part #
1/4"	CSC-T04-2	SSC-T04-2
3/8"	CSC-T06-2	SSC-T06-2
1/2"	CSC-T08-2	SSC-T08-2
3/4"	CSC-T12-2	SSC-T12-2
1"	CSC-T16-2	SSC-T16-2
1-1/4"	CSC-T20-2	SSC-T20-2
1-1/2"	CSC-T24-2	SSC-T24-2

Contact Dixon at 888.226.4673 for assembly instructions and crimp recommendations.



R

### Spring Guard

**Features**

- Protects hose against the effects of flexing at its most vulnerable point - immediately behind the coupling
- Optional end tang allows end guard to be secured under a clamp or ferrule
- Wire fits most hose O.D.s from 1/2" to 3-1/4"; contact Dixon® for custom sizes or lengths

**With Tang**

Guard I.D.	Wire Gauge	Overall Length	Tang Length	Approx. # of Coils/Ft.	Galvanized Steel Part #	304 Stainless Steel Part #
3/4"	0.175	12"	1"	33	SEGC1-0.75-12	SEGS1-0.75-12
1"	0.175	12"	1"	33	SEGC1-1.00-12	SEGS1-1.00-12
1-1/4"	0.175	14"	2"	39	SEGC1-1.25-14	SEGS1-1.25-14
1-1/2"	0.175	14"	2"	39	SEGC1-1.50-14	SEGS1-1.50-14
1-3/4"	0.175	16"	2"	44	SEGC1-1.75-16	SEGS1-1.75-16
2"	0.280	16"	2"	44	SEGC1-2.00-16	SEGS1-2.00-16
2-1/2"	0.280	18"	2"	50	SEGC1-2.50-18	SEGS1-2.50-18
3"	0.280	18"	2"	50	SEGC1-3.00-18	SEGS1-3.00-18

**Without Tang**

Guard I.D.	Wire Gauge	Overall Length	Approx. # of Coils/Ft.	Galvanized Steel Part #	304 Stainless Steel Part #
3/4"	0.175	12"	33	SEGC0-0.75-12	SEGS0-0.75-12
1"	0.175	12"	33	SEGC0-1.00-12	SEGS0-1.00-12
1-1/4"	0.175	14"	39	SEGC0-1.25-14	SEGS0-1.25-14
1-1/2"	0.175	14"	39	SEGC0-1.50-14	SEGS0-1.50-14
1-3/4"	0.175	16"	44	SEGC0-1.75-16	SEGS0-1.75-16
2"	0.280	16"	44	SEGC0-2.00-16	SEGS0-2.00-16
2-1/2"	0.280	18"	50	SEGC0-2.50-18	SEGS0-2.50-18
3"	0.280	18"	50	SEGC0-3.00-18	SEGS0-3.00-18

### Continuous Spring Guard

**Features**

- Protects hose from external abrasion and helps resist over-flexing
- Fits tight to hose reducing the potential for snagging
- Contact Dixon at 888.226.4673 for custom lengths or sizes

Guard I.D.	Wire Gauge	Overall Length	Approx. # of Coils/Ft.	Galvanized Steel Part #	304 Stainless Steel Part #
3/4"	0.175"	25'	33'	CWG-C-0.75-25	CWG-S-0.75-25
1"	0.175"	25'	33'	CWG-C-1.00-25	CWG-S-1.00-25
1-1/4"	0.175"	25'	33'	CWG-C-1.25-25	CWG-S-1.25-25
1-1/2"	0.175"	25'	33'	CWG-C-1.50-25	CWG-S-1.50-25
1-3/4"	0.175"	25'	33'	CWG-C-1.75-25	CWG-S-1.75-25
2"	0.280"	25'	33'	CWG-C-2.00-25	CWG-S-2.00-25
2-1/2"	0.280"	25'	33'	CWG-C-2.50-25	CWG-S-2.50-25
3"	0.280"	25'	33'	CWG-C-3.00-25	CWG-S-3.00-25

### GSM Ball-Joint Armored Hose Assemblies

**Application**

- Includes but not limited to: water cooling hose, oxygen supply hose, hydraulic hose, natural gas hose, black liquor hose, steam hose

**Sizes**

- 1/4" through 16" bore
- Lengths to 120'

**Features**

- Extremely flexible armor protects from heat, slag splash, and harsh environments
- A variety of end connections are available; contact Dixon at 888.226.4673

**Materials**

- Armor: galvanized steel or stainless steel
- Wide selection of inner hoses specific to the demands of the application are industrial, hydraulic, stainless steel, or PTFE

**Specifications**

- Heat resistant insulation to 1000°F
- Temperature rating depends on specific applications; consult Dixon

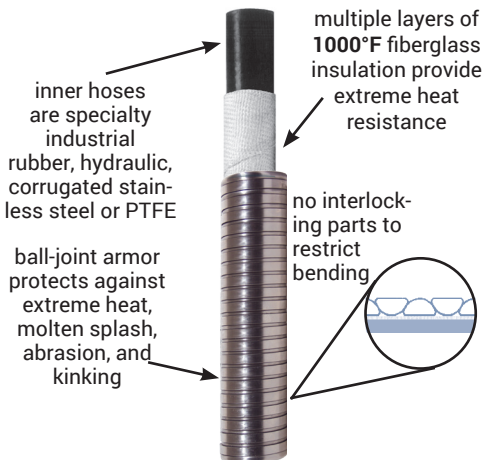

R

inner hoses are specialty industrial rubber, hydraulic, corrugated stainless steel or PTFE

ball-joint armor protects against extreme heat, molten splash, abrasion, and kinking

multiple layers of 1000°F fiberglass insulation provide extreme heat resistance

no interlocking parts to restrict bending

**Tank Truck Fittings..... 1020 - 1052**

6200-Series side lever type drop elbows ..... 1020

6500-Series self-locking drop elbows ..... 1020

Straight drop fuel delivery connectors ..... 1021

Fuel delivery elbow inlets and tubes ..... 1021

Side seal fuel delivery elbows ..... 1021

Side seal - top seal adapter ..... 1021

Elbow height extensions..... 1022

Tank cabinet weld-on adapters ..... 1022

Dual point vapor recovery elbows - ball lever ..... 1022

Single point coaxial drop elbow ..... 1023

Coaxial elbow fuel inlets ..... 1023

Tight fill drop elbows - complete unit..... 1024

Tight fill drop elbow coupler body ..... 1024

Tight fill male adapter inlet end..... 1024

TTMA flange gaskets ..... 1025

Sight flow indicators ..... 1025

TTMA flanged short sight flow indicators ..... 1025

TTMA flanged sight flow indicators..... 1025 - 1026

Sight flow indicator repair kits ..... 1026

TTMA flange screen..... 1026

Reelcraft® static discharge reel..... 1027

TFA series fill pipe adapter ..... 1028

Fuel delivery tank adapters ..... 1028

Vapor recovery tank adapters ..... 1028

API drop adapters ..... 1029

API dust caps ..... 1029

Gravity drop adapter dust caps..... 1030

Dixon® bayco adapter with grounding tab ..... 1030

Dixon bayco coupler with grounding tab ..... 1030

Fuel gaskets ..... 1030

Tank truck flanged tee ..... 1031

TTMA series flange adapters ..... 1031

TTMA flange spacer with 1/2" port..... 1032

TTMA flange extensions..... 1032

Cam & groove adapter x TTMA flange ..... 1032

Cam & groove coupler x TTMA flange ..... 1032

Cam & groove 22-1/2° adapter x TTMA flange..... 1032

Cam & groove 22-1/2° coupler x TTMA flange ..... 1032

Dixon vapor recovery couplers ..... 1033

Dixon vapor recovery ..... 1034

EZ Boss-lock® vapor recovery coupler x TTMA flange..... 1034

Vapor caps..... 1035

Automatic pressure / vacuum relief caps ..... 1035

Standard vent caps for stationary tanks ..... 1036

Fuel delivery adapter cap ..... 1036

Tank transport equipment ..... 1037

Intermodal tank transport ..... 1038

Bayonet style dry disconnects ..... 1039 - 1040

Ball nozzles for bulk delivery ..... 1041

Gravity utility nozzles..... 1042

Pressure nozzles for bulk delivery ..... 1042

Large capacity low pressure / gravity nozzle ..... 1043

Diesel and gasoline nozzle accessories ..... 1043

Hose shank hose swivels ..... 1044

Heavy duty hose swivels ..... 1044

Dixon MannTek hose swivels ..... 1044

Dixon diesel and gasoline nozzles accessories ..... 1045

FuelMaster™ diesel nozzles..... 1046

Big Mouth™ diesel nozzles ..... 1047

Farm and consumer nozzles ..... 1048

DEF automatic shutoff nozzle..... 1049

High flow fueler 100™ nozzles..... 1049

Dixon MannTek full flow ball valves..... 1050 - 1051

Betts wet-r-dri™ butterfly valves ..... 1052



### 6200-Series Side Lever Type Drop Elbows

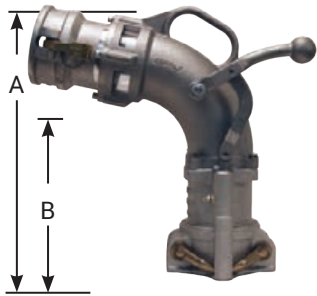

side lever with 4" coupler inlet



side lever without inlet connection

**Materials**

- Cast aluminum modular construction
- Handle and cam arms: brass with nitrile rubber gasket
- Bolts on inlet end: stainless steel
- Sight glass: acrylic with nitrile rubber seals
- For information on additional elbow configurations such as pre-assembled elbows, contact Dixon®

Size	Inlet	A Overall Height	B Ground Clearance	Aluminum Part #
4"	elbow only, without inlet connection	17-3/4"	10-7/8"	6200
	elbow with 3" adapter inlet			6200C
	elbow with 4" adapter inlet			6200A
	elbow with 3" coupler inlet			6200B
	elbow with anti-spill sleeve, without inlet connection			6200T
	elbow with 4" adapter inlet and anti-spill sleeve			6200AT
	elbow with 4" coupler inlet			6200D
	tall elbow only, without inlet connection	21"	13-3/4"	6200X
	tall elbow with 3" adapter inlet			6200XC
	tall elbow with 4" adapter inlet			6200XA
	tall elbow with 3" coupler inlet			6200XB
	tall elbow with anti-spill sleeve, without inlet connection			6200XT
	tall elbow with 4" adapter inlet and anti-spill sleeve			6200XAT
	tall elbow with 4" coupler inlet			6200XD

### 6500-Series Self-Locking Drop Elbows



no inlet

Size	Inlet	A Overall Height	B Ground Clearance	Aluminum Part #
4"	tightfill elbow with locking handle	17-3/4"	10-7/8"	6500
	tightfill elbow with 3" inlet adapter			6500C
	tightfill elbow with locking handle and 4" adapter inlet			6500A
	tightfill elbow with 3" coupler inlet			6500B
	tightfill elbow with 4" coupler inlet			6500D
	tightfill elbow with locking handle and anti-spill sleeve, without inlet connection			6500T
	tightfill elbow with locking handle, 4" inlet adapter and anti-spill sleeve			6500XAT
	tall full feature elbow, without inlet connection	21"	13-3/4"	6500X
	tall full feature elbow with 3" inlet adapter			6500XC
	tall full feature elbow with 4" inlet adapter			6500XA
	tall full feature elbow with 3" coupler inlet			6500XB
	tall full feature elbow with 4" coupler inlet			6500XD
	tall full feature elbow with locking handle, no inlet, with anti-spill sleeve			6500XT
	tall elbow with locking handle, 4" inlet adapter and anti-spill sleeve			6500XAT
3"	3" tight fill elbow with 4" inlet adapter	15"	9-1/2"	6530A
3"	3" tightfill elbow with 3" coupler inlet			6530B
4"	3" tight fill elbow with 3" inlet adapter			6530C
3"	3" tightfill elbow with 4" coupler inlet	15"	9-1/2"	6530D
	3" tightfill elbow with 4" inlet adapter and locking handle			6530LA
	tightfill elbow main gasket 3"			112449



### Straight Drop Fuel Delivery Connectors

Inlet Size	Outlet	Overall height	Part #
3"	4" top seal	17-5/8"	6303
4"		16-3/16"	6304
3"		19-3/4"	6303NPT
4"		19-3/16"	6304NPT



### Fuel Delivery Elbow Inlets and Anti-Spill Tubes

#### Male Adapters

Inlet Size	Aluminum Part #
3"	6000-16
4"	6000-17



#### Female Couplers

Inlet Size	Aluminum Part #
3"	6000-15
4"	6000-14



#### Female NPT

Inlet Size	Aluminum Part #
4"	6000-20



#### Anti-Spill Sleeves

Description	Part #
anti-spill tube for 6200 and 6500	6200-17
tall anti-spill tube for 6200 and 6500	6200X-17



### Side Seal Fuel Delivery Elbows

Inlet Size	Description	Part #
---	side seal elbow without inlet connection	6000AS
3"	side seal elbow with 3" inlet adapter	6000ASC
4"	side seal elbow with 4" inlet adapter	6000ASA
3"	side seal elbow with 3" coupler inlet	6000ASB
4"	side seal elbow with 4" coupler inlet	6000ASD
---	side deal elbow without inlet connection, with anti-spill sleeve	6000AST
4"	side deal elbow with 4" inlet adapter, with anti-spill sleeve	6000ASAT
4"	side seal elbow with 4" inlet adapter, with locking ring	6000ASAL
---	optional add on locking ring prevents lever from moving	6000ASR



### Side Seal to Top Seal Adapters

#### Application

- Allows conventional elbows to be used with special side seal style fill collars

#### Features

- Bottom connects to side seal fill collar
- Top section with standard 4" top seal collar profile accepts clamping of standard 4" drop elbows
- Replacement parts are available; contact Dixon

Size	Aluminum Part #
4"	6000-SSA



### Elbow Height Extensions



Description	Part #
3" height extension kit for 6200, 6500, VR6000, and VR6500 elbows. Kit includes: body and stem extensions, (4) stainless steel nuts and bolts and stem pin	6000EXT
3" height extension kit for 6400 co-axial elbows. Kit includes: body and stem extensions, (4) stainless steel nuts and bolts, stem pin, and replacement vapor tube	6400EXT



### Tank Cabinet "Dummy" Weld-on Adapters

Description	Part #
4" fuel delivery - cabinet weld-on adapter blank	AL4051-BORE

### Dual Point Vapor Recovery Elbows - Ball Lever

#### Application

- For use in two-point vapor recovery systems

#### Features

- One-piece locking arms
- Advanced design side lever locking system
- Bolt on 3" male outlet included (VR6000-6), which can be rotated for extended life
- Lubrication fitting on locking stem
- See below for 6400-series co-axial elbow for single point vapor recovery

#### Materials

- Seals: nitrile rubber
- Hardware: stainless steel
- Bronze locking arms housed in polymer bushings



Description	Aluminum Part #
3" male adapter outlet, without poppet valve	VR6000NP
3" male adapter outlet, without poppet valve	VR6100NP
ball lever handle, without adapter outlet, without poppet valve	VR6200NPBU
3" male adapter with probe, without poppet valve	VR6200NP
3" male adapter outlet with probe and poppet valve	VR6200
3" male adapter outlet, ball lever handle, without poppet valve	VR6200PNP
4" male adapter outlet, ball lever handle, without poppet valve	VR6200ANP
3" male coupler outlet, ball lever handle, without poppet valve	VR6200NPB
3" male coupler outlet, ball lever handle, without poppet valve	VR6200NPBP
4" male coupler outlet, ball lever handle, without poppet valve	VR6200NPDP
3" male adapter outlet, heavy duty ball valve and poppet valve	VR6500
3" male adapter outlet, heavy duty ball valve, without poppet valve	VR6500NP
3" male adapter outlet, heavy duty ball lever locking handle, without poppet valve	VR6500LPNP

### Adapter Inlet



Description	Aluminum Part #
outlet adapter with outlet O-ring	VR6000-6
replacement 4" adapter outlet, for elbows without poppets	6000-17
replacement 3" coupler outlet, for elbows without poppets	6000-15
replacement 4" coupler outlet, for elbows without poppets	6000-14



## Single Point Coaxial Drop Elbow

### Application

- For single point vapor recovery only

### Features

- 3" male vapor outlet (top)
- Comes assembled with 4" male inlet
- Bolt-on inlets/outlets for easy, fast replacement
- Replacement parts are available; please contact Dixon®
- 6400 co-axial inlets do not fit our other elbow series

### Materials

- Arms: solid bronze
- Sight glass: acrylic
- Seals: nitrile rubber

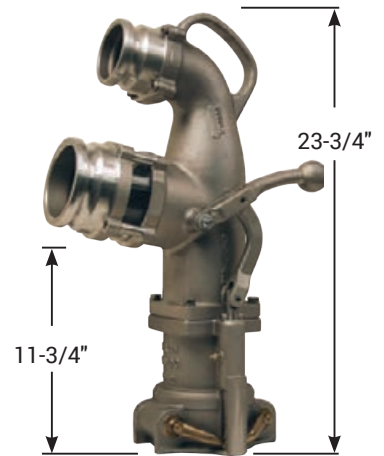

Inlet	Outlet	Aluminum Part #
3" adapter fuel	3" male vapor	6430
3" coupler fuel		6430F
4" adapter fuel		6400
4" coupler fuel		6400F
4" coupler fuel	3" male NPT vapor	6400FNPT
3" adapter fuel	3" male vapor	6430X
3" coupler fuel		6430XF
4" adapter fuel		6400X
4" coupler fuel		6400XF
4" coupler fuel	3" male NPT vapor	6400XFNPT

## Coaxial Elbow Fuel Inlets

### Adapters

#### Application

- For use with 6400-series coaxial elbows only

#### Feature

- Rated for petroleum service, Ethanol to E100, and biodiesel to B20

Size	Aluminum Part #
3"	6000-16C
4"	6000-17C



### Couplers

#### Application

- For use with 6400-series coaxial elbows only

#### Feature

- Rated for petroleum service, Ethanol to E100, and biodiesel to B20

Size	Aluminum Part #
3"	6000-15C
4"	6000-14C



### Vapor Outlets

Size	Aluminum Part #
3"	6000-4
3"	6000-26C



**Tight Fill Drop Elbows - Complete Unit**



**Materials**

- Body: aluminum
- Handle and cam arms: brass
- Gasket: nitrile rubber
- Bolts on inlet end: steel
- Sight flow insert: plexiglass

Coupler Size	Inlet	Aluminum Part #
3"	3" male adapter	300300MAE
	4" male adapter	3004030MAE



**Tight Fill Drop Elbow Coupler Body**

Size	Aluminum Part #
3"	300-TFG



**Tight Fill Male Adapter Inlet Ends**

Inlet	Aluminum Part #
3"	300-MAE
4"	4030-MAE



### TTMA Flange Gaskets

Size	O.D.	I.D.	Thick.	Material	Part #
2"	4-1/2"	2-5/8"	1/8"	Baylast™	200GTTFBL
	5-5/8"	3-1/2"	1/8"	Cork / Nitrile rubber	300GTTFCB
	5-5/8"	3-1/2"	1/16"	PTFE envelope with Klinger filler	300GTTFTK
3"	5-5/8"	3-1/2"	1/8"	Klingersil® C-4300	300GTTFK
	5-29/32"	3-1/2"	3/32"	PTFE with fiber core	40321TF
	7-1/4"	5"	5/32"	PTFE with soft fiber core	40364TF
	7-1/4"	5"	1/8"	Baylast	40364BL
	5-5/8"	3-5/8"	1/8"	Baylast	300GTTFBL
4"	6-5/8"	4-9/16"	1/8"	Cork / Nitrile rubber	400GTTFCB
	6-5/8"	4-9/16"	1/16"	PTFE envelope with Klinger filler	400GTTFTK
	6-5/8"	4-9/16"	1/8"	Klingersil C-4401	400GTTFK
	6-7/8"	4-9/16"	3/32"	PTFE with fiber core	40322TF
	8-3/8"	5-7/8"	5/32"	PTFE with soft fiber core	40323TF
	8-1/4"	5-7/8"	1/8"	Baylast	40323BL
	6-5/8"	4-5/8"	1/8"	Baylast	400GTTFBL



NOTE: For flange dimensions, diagrams and additional information please reference dixonvalve.com.

### Sight Flow Indicators

**Features**

- Due to the proprietary blending of petroleum products, Dixon® recommends that thermoplastic tubing and gaskets be immersion tested in the product to be handled to ensure compatibility (not compatible with crude oil)
- For dimensional information on tank truck flange drilling reference dixonvalve.com



**Specification**

- Maximum flange bolt torque is 200 in. lbs.



### TTMA Flanged Short Sight Flow Indicators

**Features**

- Durable cast aluminum housing, replaces competition's all-acrylic sight glass as commonly found on tank trucks
- Allows for visual identification of the fuel grade prior to opening the valve
- Works with tank truck flanged butterfly valves found on gasoline trucks
- Low cost sight glass tube can be easily replaced

**Specification**

- Rated to 150 PSI



Size	Width	Aluminum Part #
3"	1-3/4"	5200-SFI-3
4"	1-3/4"	5200-SFI

### TTMA Flanged Sight Flow Indicators

**Application**

- Allows for visual identification of the fuel grade prior to opening the valve

**Features**

- Works with tank truck flanged butterfly valves found on gasoline trucks
- Larger I.D. 4-3/8" flow indicator allows tank truck flanged butterfly valves to connect to either end of the indicator

**Specification**

- Pressure rating: 150 PSI

Size	Width	I.D.	Aluminum Part #
4"	3-1/4"	4-3/8"	5201-SFI

**Application**

- Allows for visual identification of the fuel grade prior to opening the valve

**Specification**

- 4" flow diameter

Size	I.D.	Aluminum Part #
4"	4-3/8"	4-1460-AL



NOTE: For flange dimensions, diagrams and additional information please reference dixonvalve.com.

### TTMA Flanged Sight Flow Indicators



Size	Nominal Width	Acrylic Part #
3"	1-3/4"	TT3ASG
4"		TT4ASG
3"		TT3ASG-ETH <sup>1</sup>
4"		TT4ASG-ETH <sup>1</sup>

#### Optically Enhanced Sight Glass

Size	Nominal Width	Acrylic Part #
3"	1-3/4"	TT3ASGOE
4"		TT4ASGOE
3"		TT3ASG-ETHOE <sup>1</sup>
4"		TT4ASG-ETHOE <sup>1</sup>

<sup>1</sup> For use with ethanol

NOTE: For flange dimensions, diagrams and additional information please reference dixonvalve.com.

### Sight Flow Indicator Repair Kits



5200-SFIV-RK1

Description	Used on	Part #
3" replacement sight glass, Baylast™ O-ring, and retainer ring kit	---	5200-SFI-3-RK1
3" replacement sight glass, FKM O-ring, and retainer ring kit	---	5200-SFI-3V-RK1
4" replacement sight glass, Baylast O-ring, and retainer ring kit	---	5200-SFI-RK1
4" replacement sight glass, FKM O-ring, and retainer ring kit	---	5200-SFIV-RK1
replacement Baylast O-rings, sight glass and retaining ring	5201-SFI	5201-SFI-RK1
nitrile rubber O-ring	---	O249BU
plexiglass insert	4-1460-AL	4PSG
nitrile rubber O-ring	4-4160-AL	O246BU

### TTMA Flange Screen

#### Material

- Stainless steel screen is encapsulated in an FKM gasket

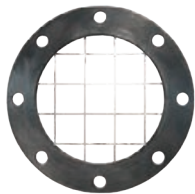

Male NPT	Description	Stainless Steel Part #
2"	screen with 1" square holes	TTFS4SS

NOTE: For flange dimensions, diagrams and additional information please reference dixonvalve.com.

## Reelcraft® Static Discharge Reel

### Application

- Used to ground equipment in hazardous atmospheres, such as fuel trucks or carts transferring flammable materials; when properly clamped to ground, the static discharge reel dissipates static electrical buildup, reducing the chances of sparking and the potential for explosion

### Features

- Supplied with a 3/32" O.D. steel aircraft cable
- DC resistance is approximately one ohm per 50' of steel cable



Description	Stranded Steel Part #
single 7" x 7" stranded steel	G3050

### TFA Series Fill Pipe Adapter



**Application**

- For use with 3" drop elbows (300-TFG)

Adapter Size	Female NPT	Aluminum Hardcoat Part #	Optional Qty
3"	3"	300-TFA	10



with NPSM thread



with NPT thread

### Fuel Delivery Tank Adapters

**Application**

- For use with 4" drop and co-axial elbows (6200, 6400 and 6500 series)

**Specification**

- BZ4051S has NPSM thread and is supplied with a gasket

Adapter Size	Female Thread	Height	Bronze Part #	Optional Qty
4"	4" NPSM	2-3/8"	BZ4051S	5
	4" NPT	3-1/2"	BZ4051	5

### Vapor Recovery Tank Adapters

**Application**

- For use with dual point vapor elbows (VR6200 series)

**Features**

- Can also be used as vapor valve on tanker but does not have air interlock mount
- Poppeted vapor collar at station vapor outlet
- Low profile design
- Replacement parts are available; contact Dixon® for more information



Adapter Size	Female Thread	Height	Material	Part #	Optional Qty
4"	4" NPT	3-5/8"	bronze	VR4086	5
			ZN-AL alloy	VR4086-BY	5

## API Drop Adapters

### Application

- For offloading through an API adapter

Adapter Size	Coupler Size	Description	Aluminum Part #
3"	4" API	with Baylast™ O-ring seal	4530
		with nitrile rubber flat gasket	4530G
4"		with Baylast O-ring seal	4540
		with nitrile rubber flat gasket	4540G
		with nitrile rubber O-ring seal	4540F



### API Drop Adapters with Sight Glass

Adapter Size	Coupler Size	Description	Aluminum Part #
3"	4" API	with inline sight glass and Baylast flat gasket	4530SG
4"		with inline sight glass and Baylast flat gasket	4540SG



### API Gravity Drop Adapters

Adapter Size	Coupler Size	Description	Aluminum Part #
3"	4" API	with flat nitrile rubber gasket	31440-225AL
4"		with flat nitrile rubber gasket	41440-225AL



### API Drop Adapter Repair Kits

Description	Part #
replacement cam arms, pins, and Baylast O-ring seal (standard)	4500RK
replacement cam arms, pins, and FKM O-ring seal (optional)	4500RK-V
replacement 18" chain and S hook	5205-RK4
sight glass repair kit (fits 3" and 4")	4540SG-RK1
flat replacement Baylast gasket for 4530SG, 4540SG	4540SG-RK2
replacement cam arms and pins (fits 3" and 4")	4540SG-RK3
Baylast O-ring replacement seal for 4530, 4540, 5000-24	4500-5
flat nitrile rubber gasket for 4530G, 4540G	112054
flat replacement gasket for 31440-225AL, 41440-225AL, 41450-DCAL	2143SEALBU



4540SG-RK1

### API Dust Caps

Size	Description	Aluminum Part #	Optional Qty
4" API	with flat nitrile rubber gasket and brass cam arms	41450-DCAL	5
	with O-ring Baylast seal and brass cam arms	5000-24	10
	with locking arms	5000-24L	1



with cam arms

Adapter Size	Description	Nylon Part #	Optional Qty
4" API	with flat nitrile rubber seal and plated steel pad lockable roller lever	5000-25	20



with locking arms

### Gravity Drop Adapter Dust Caps



4540DC



4540DC-1200

**Application**

- Designed to fit on any 4" cam and groove adapter, specifically 4" gravity drop adapters

**Features**

- Reduce weight
- Easy pull off / push on operation
- NOT intended to be pressurized



**Material**

- Nitrile rubber gasket

Size	Black Nylon Part #
4"	4540DC
	4540DC-1200 <sup>1</sup>

<sup>1</sup> Supplied with chain

### Dixon Bayco® Adapter with Grounding Tab



Size	Description	356T6 Aluminum Part #
4"	male adapter with grounding tab	400-E-ALGT

### Dixon Bayco Coupler with Grounding Tab



Size	Description	356T6 Aluminum Part #
4"	female coupler with grounding tab	400-C-ALGT

### Fuel Gaskets

S



Size	Material	Part #
1-1/2"	nitrile rubber	150-G-BF
2"	nitrile rubber	200-G-BF
3"	nitrile rubber	300-G-BF
4"	nitrile rubber	400-G-BF
3"	extra thick nitrile rubber	300GTHKBF
4"	extra thick nitrile rubber	400GTHKBF



### Tank Truck Flanged Tee

Size	356T6 Aluminum Part #
4"	400-TLT-AL



### TTMA Series Flange Adapters

**Application**

- Simply and easily converts threaded components to a standard TTMA flange configuration

**Features**

- Solid cast lightweight aluminum design is more durable than welded fabrications
- Design improves flow through adapter
- Compact size reduces the overall space needed to install

#### TTMA Flange x Male NPT Adapters

TTMA Flange	Male NPT	Overall Length	Aluminum Part #
3"	3"	2-1/2"	TTF3AL-3MT
4"	3"	2-1/2"	TTF4AL-3MT
4"	4"	2-1/2"	TTF4AL-4MT



#### TTMA Flange x Extended Length Male NPT Adapters

TTMA Flange	Male NPT	Overall Length	Aluminum Part #
4"	3"	5-1/2"	TTF4AL-3EMT
	4"	5-1/2"	TTF4AL-4EMT



#### TTMA Flange x Female NPT Adapters

TTMA Flange	Female NPT	Overall Length	Aluminum Part #
4"	3"	2-1/2"	TTF4AL-3FT
	4"	2-1/2"	TTF4AL-4FT



#### TTMA Slip-on Socket Weld Flange

TTMA Flange	Pipe Size	356T6 Aluminum Part #
4"	4"	TTF400SP



#### TTMA Slip-on Plate Flange

TTMA Flange	Pipe Size	Aluminum Part #
4"	4"	TTMA-64



#### TTMA Buttweld Flanges

TTMA Flange	Pipe Size	Thickness	Aluminum Part #
3"	4"	3/8"	TTF3AL
4"	4"	3/8"	TTF4AL



NOTE: For flange dimensions, diagrams and additional information please reference [dixonvalve.com](http://dixonvalve.com).



### TTMA Flange Spacer with 1/2" Port



Size	Description	Aluminum Part #
4"	flange spacer with 1/2" female NPT port	TTFS4AL-FP50

### TTMA Flange Extensions

**Application**

- Used on load arms to connect an API load coupler to a load arm

**Features**

- Adds a 6" space between the load arm and the tank truck
- Extension with groove provides a specified parting point to prevent excessive damage to the loading arm



TETF4AL



TETFG4AL

Size	Description	Aluminum Part #
4"	TTMA flange extension	TETF4AL
4"	TTMA flange extension with groove	TETFG4AL
4"	TTMA flange extension with 1/2" female NPT port	TETF4ALFP50

NOTE: For flange dimensions, diagrams and additional information please reference dixonvalve.com.

### Cam & Groove Adapters x TTMA Flange

**Features**

- Aluminum flanges have a flat face; stainless flanges have a raised face
- Reference dixonvalve.com for flange drilling standards
- Pressure rating is based on the seal of the mating part, see ratings on pages 20, 26



Size	356T6 Aluminum Part #	316 Stainless Steel Part #
2" x 3"	2030-ALT-AL	---
3"	300-ALT-AL	300-ALT-SS <sup>1</sup>
3" x 4"	3040ALTAL	---
4"	400-ALT-AL	400-ALT-SS <sup>1</sup>
6"	600-ALT-AL	---

<sup>1</sup> Parts are produced as a welded fabrication

### Cam & Groove Couplers x TTMA Flange

**Features**

- Supplied standard with a nitrile rubber gasket; other gaskets available on pages 68 - 71
- Use Dixon® replacement handles only



Size	356T6 Aluminum Part #
3"	300-DLT-AL
3" x 4"	3040DLTAL
4"	400-DLT-AL
6"	600-DLT-AL

NOTE: For flange dimensions, diagrams and additional information please reference dixonvalve.com.

### Cam & Groove 22-1/2° Adapters x TTMA Flange

**Feature**

- Pressure rating is based on the seal of the mating part, see ratings on pages 20, 26



Size	356T6 Aluminum Part #
3"	30022ALTAL
4"	40022ALTAL

### Cam & Groove 22-1/2° Couplers x TTMA Flange

**Features**

- Supplied standard with a nitrile rubber gasket; other gaskets available on pages 68 - 71
- Use Dixon replacement handles only



Size	356T6 Aluminum Part #
4"	40022DLTAL

NOTE: For flange dimensions, diagrams and additional information please reference dixonvalve.com.

## Dixon® Vapor Recovery Couplers

### Application

- Not intended for liquid service, for vapor recovery only 

### Materials

- Body: cast aluminum
- Arms: bronze with stainless steel pins
- Finger rings: plated carbon steel
- Gasket: nitrile rubber

### Coupler with Probe x Adapter

Coupler Size	Adapter Size	356T6 Aluminum Part #
4"	3"	4030-DAVR-AL



### Coupler with Probe x Coupler with Probe

Coupler Size	Coupler Size	356T6 Aluminum Part #
4"	4"	400-DDVR-AL



### Couplers with Probe x Hose Shank

#### Applications

- For use with 3" vapor hose
- Not intended for liquid service, for vapor recovery only 

#### Features

- VR4030CS-AL has an FKM O-ring poppet seal
- Dixon replacement handle assemblies will not work on these fittings, contact Dixon for replacements 

#### Materials

- Cast aluminum body
- Arms: bronze
- Pins and finger rings: stainless steel
- Gasket: nitrile rubber



VR4030CS-AL

Coupler Size	Hose Shank Size	Description	Part #
3"	3"	---	VRC3000AL
4"	2"	---	4020-CVR-AL
4"	3"	no poppet	4030-CVR-AL
4"	3"	poppet	VR4030CS-AL <sup>1</sup>
4"	3"	floating bridge poppet	VR4030CS-SH <sup>2</sup>
4"	4"	no poppet	400-CVR-AL
4"	4"	floating bridge poppet	VR4040CS-AL <sup>2</sup>



VRC.3000AL

<sup>1</sup> Interchanges with all competitor vapor valves *except* Civacon #633LVH (special bulb design) 

<sup>2</sup> Superior interface with air interlock

### Repair Kits

Description	Part #
seal repair kit: gasket, machine screw, and FKM O-ring	VR4040CSRK1
cam arm repair kit: paddle arm and cam arm pin	VR4040CSRK2



4030-CVR-AL

## Dixon® Vapor Recovery Couplers



VR4030CS-AL45



VR4040CS-AL

### Application

- Not intended for liquid service, for vapor recovery only



### Features

- 'Floating bridge' poppet design allows optimal flow
- Machined hose shank ensures easier insertion into hose and better sealing
- Durable, easy-to-couple stainless cam arms
- Big wings ensure contact with air interlock button on tanker, helping prevent drive-offs
- Change poppet seal without removing the coupler from the hose
- Secure to hose with traditional band clamps or built in crimp collar
- 4" MNPT version allows for either cam and groove or threaded flange option

### Material

- Seal: Nitrile rubber and FKM

Coupler Size	Description	Aluminum Part #
4"	4" coupler x 4" hose shank	VR4040CS-AL
	4" coupler x 3" 45° hose shank	VR4030CS-AL45
	4" coupler x 4" 45° hose shank	VR4040CS-AL45
	4" coupler x 4" 45° hose shank swivel	VR4040CS-ALS45
	4" coupler x 4" MNPT connection	VR4040CS-4MNPT
	4" coupler x 3" hose shank	VR4030CS-SH

## Bayloc Vapor Coupler with Locking Handle

### Application

- For use in petroleum loading terminals

### Materials

- Body: aluminium
- Seals: FKM

### Specification

Maximum operating pressure: 120 PSI



DBC62LVPR-300

Size	Part #
3"	DBC62LVPR-300

NOTE: Must be used with a 4100FNG series check valve

## Repair Kits

Description	Part #
handle kit	VRHK
compact handle kit	VRHK-C
seal repair kit	VR4040CSRK1
cam arm repair kit	VR4040CSRK2



VRHK

## Couplers x Female NPT

### Application

- Not intended for liquid service, for vapor recovery only



### Materials

- Body: cast aluminum
- Arms: bronze with stainless steel pins
- Finger rings: plated carbon steel
- Gasket: nitrile rubber

Coupler Size	Female NPT Size	356T6 Aluminum Part #
4"	3"	4030-DVR-AL
	4"	400-DVR-AL



## EZ Boss Lock® Vapor Recovery Coupler with Probe x TTMA Flange



### Materials

- Body: 356T6 aluminium
- Arms: stainless steel EZ Boss-Lock
- Gasket: nitrile rubber

Coupler Size	Flange Size	356T6 Aluminum Part #
4"	4"	ADLTVR400EZ

## Vapor Caps

### Aluminum

**Features**

- Special locking cap for underground tank vapor outlet VR4086 and tanker vapor valves
- Painted vapor recovery orange

**Material**

- Bronze cam arms



Size	Aluminum Part #
4"	VR4050AL

### Nylon

**Features**

- Centered 'T' handle allows for one-handed use and provides a solid locking mechanism
- Strong and lightweight
- Built-in locking feature
- Corrosion resistant materials
- Vapor recovery orange
- Replacement parts are available; contact Dixon® for more information



Size	Nylon Part #
4"	VR4050PL

## Automatic Pressure / Vacuum Relief Caps

**Features**

- Normally closed; stops fuel evaporation and airborne contaminants
- Lockable
- Relieves pressure and vacuum buildup in fuel tanks

NOTE: Pressure/vacuum relief caps should be routinely inspected to ensure correct operation and particularly to ensure that the relieving components are free to move and that the air flow path is unblocked.



### For stationary fuel tanks

**Feature**

- Relieves vacuum at .7 Hg (.33 PSI) and pressure at 2 PSI, 20 SCFM flow

Male NPT	Zinc Part #
2"	2000L
2-1/2"	2500L



### For mobile fuel tanks

**Feature**

- Relieves vacuum at .33 Hg and pressure between 7.5 - 9 PSI

Male NPT	Zinc Part #
2"	200-PV-9



S

**Standard Vent Caps for Stationary Tanks**



**Features**

- Allows venting of tank to atmosphere at all times
- Also referred to as a breather cap
- Does not have pressure or vacuum valves

Male NPT	Aluminum Part #
2-1/2"	2500SFV

**Fuel Delivery Adapter Cap**



**Features**

- Single action locking cap
- Replacement parts are available; contact Dixon® for more information

**Material**

- Bronze cam arms

Size	Aluminum Part #	Optional Qty
4"	SA4050AL	10

## Tank Transport Equipment

### Fusible Pipe Caps

Size	Stainless Steel <sup>1</sup> Part #	Aluminum Part #	Iron Part #	Optional Qty
3"	300-SFC-SS	300-SFC-AL	300-SFC-MI	10

NOTE: Female NPSM threaded

<sup>1</sup> PTFE gaskets are standard in stainless steel fittings.



### Pipe Caps

Size	Stainless Steel <sup>1</sup> Part #	Aluminum Part #	Iron Part #	Optional Qty
2"	200-PC-SS	---	200-PC-MI	---
3"	300-PC-SS	300-PC-AL	300-PC-MI	10
4"	400-PC-SS	---	---	---

<sup>1</sup> PTFE gaskets are standard in stainless steel fittings.



### Reducers

Female NPSM	Male NPT	Stainless Steel <sup>1</sup> Part #	Aluminum Part #	Iron Part #	Optional Qty
3"	2"	3020-RD-SS	3020-RD-AL	3020-RD-MI	10
4"	3"	4030-RD-SS <sup>2</sup>	4030-RD-AL	---	---

<sup>1</sup> PTFE gaskets are standard in stainless steel fittings.

<sup>2</sup> welded fabrication



### Reducing Cap

Size	Stainless Steel <sup>1</sup> Part #	Optional Qty
3" x 1"	3010-RC-SS	10

NOTE: Female NPSM x Female NPT

<sup>1</sup> PTFE gaskets are standard in stainless steel fittings.



### Coupling Gaskets

Size	Nitrile Rubber Part #	Opt Qty	PTFE Part #	Opt Qty
1-1/2"	---	--	150GPCTF	--
2"	200GPCBU	25	200GPCTF	10
3"	300GPCBU	25	300GPCTF	25
4"	---	--	400GPCTF	--



Nitrile Rubber



PTFE



Intermodal Tank Transport



Pipe Caps

Size	Aluminum Part #	Stainless Steel <sup>1</sup> Part #	Optional Qty
3"	300PCALAP	300PCSSAP	10

<sup>1</sup> PTFE gaskets are standard in stainless steel fittings



Thread Adapters

Female BSPP	Male NPT	Stainless Steel <sup>1</sup> Part #
3"	2"	3020RDSSAP
	3"	3030RDSSAP

<sup>1</sup> PTFE gaskets are standard in stainless steel fittings



Cam & Groove Adapter

Female BSPP	Stainless Steel <sup>1</sup> Part #
3"	300ASSAP

<sup>1</sup> PTFE gaskets are standard in stainless steel fittings





## Bayonet Style Dry Disconnects

### Application

- For the spill-less transfer of petroleum products such as fuel oil, lube oil blending, and tank truck delivery

### Features

- Ensures a spill-free connection. Fluid cannot flow until couplings are connected together and valve is opened; coupling can then not be disconnected until the valve handle is closed
- Swivels have standard ZERK fittings
- Replacement parts available; contact Dixon for more information

### Specifications

- Maximum operating pressure: **85 PSI at 70°F (21°C)**, for pressure ratings at other temperatures contact Dixon®

#### 90° Swivel Couplers x Female NPT

Size	Seal Material	Anodized Hard Coat Aluminum Part #
2"	nitrile rubber	BS61-200
	FKM	BS62-200
3"	nitrile rubber	BS61-300
	FKM	BS62-300



#### Straight Couplers x Female NPT

Size	Seal Material	Anodized Hard Coat Aluminum Part #
2"	nitrile rubber	BC61-200
	FKM	BC62-200



#### Keyed Straight Couplers x Female NPT

Size	Seal Material	Anodized Hard Coat Aluminum Part #
2"	nitrile rubber	BC61K1-200
	FKM	BC62K1-200



New

#### Straight Swivel Couplers x Female NPT

Size	Seal Material	Anodized Hard Coat Aluminum Part #
1"	nitrile rubber	BSS61-100
2"	nitrile rubber	BSS61-200
	FKM	BSS62-200
3"	nitrile rubber	BSS61-300
	FKM	BSS62-300



#### Keyed Straight Swivel Couplers x Female NPT

Size	Seal Material	Anodized Hard Coat Aluminum Part #
2"	nitrile rubber	BSS61K1-200
	FKM	BSS62K1-200

New



S

#### Straight Swivel

Size	Seal Material	PSI @ 75°F (24°C)	Anodized Hard Coat Aluminum Part #
1"	nitrile rubber	85	BSSW61-100

## Bayonet Style Dry Disconnects

### Application

- For the spill-less transfer of petroleum products such as fuel oil, lube oil blending, and tank truck delivery

### Features

- Ensures a spill-free connection. Fluid cannot flow until couplings are connected together and valve is opened; coupling can then not be disconnected until the valve handle is closed
- Swivels have standard ZERK fittings
- Replacement parts available, contact Dixon for more information

### Specifications

- Maximum operating pressure: **85 PSI at 70°F (21°C)**, for pressure ratings at other temperatures contact Dixon®

### Adapters x Female NPT



Size	Seal Material	Stainless Steel Part #	Brass Part #	Aluminum Part #
1"	nitrile rubber	---	BA61-100	---
2"	nitrile rubber	BA31-200	---	---
	FKM	BA32-200	---	---
3"	nitrile rubber	---	BA31-300	BA61-300
	FKM	---	BA32-300	BA62-300

New



### Keyed Adapters x Female NPT

Size	Seal Material	Stainless Steel Part #
2"	nitrile rubber	BA31K1-200
	FKM	BA32K1-200

### Dust Plugs



Size	Rubber with Stainless Steel Chain Part #
2"	BCP-200
3"	BCP-300

### Dust Caps



Size	Rubber with Stainless Steel Chain Part #
2"	BAC-200
3"	BAC-300

S

## Ball Nozzles for Bulk Delivery

### Feature

- Rugged construction, high flow provides rapid fuel oil transfer/delivery

### Specifications

- Heavy duty roller ball swivel with low temperature seals freely rotates without leaking at -40°F (-40°C) and 100 PSI
- 3 PSI check valve is included to prevent back flow; 5 PSI is optional

### Nozzles

Female NPT Inlet	Outlet Type	Anodized Aluminum Part #
1-1/4"	swivel quick fill nut	BL062
1-1/2"	swivel quick fill nut	BL064
1-1/4"	1-1/4" spout	BL066
1-1/2"	1-1/4" spout	BL068
1-1/2"	1-1/2" spout	BL072
1-1/4"	1-1/4" female NPT	BL066NS
1-1/2"	1-1/4" female NPT	BL068NS
1-1/2"	1-1/2" female NPT	BL072NS
2"	2" spout	BL920



BL062

### Replacement Spouts

Size	Replacement For	Aluminum Part #
1-1/4"	BL066, BL068	1143A
1-1/2"	BL072, BL919	1125A
2"	BL920	391137



BL072

### Repair Kits

#### Repair Kits for Ball Nozzles (BL066, BL068, BL072, BL919)

Description	Part #
inlet swivel seal and wear kit	SWMF-RK2
complete inlet swivel rebuild kit	SWMF-RK3
1-1/2" FNPT replacement inlet swivel	SWMF-RK4
1-1/4" FNPT replacement inlet swivel	SWMF-RK5
1-1/2" BSPP replacement inlet swivel	SWMF-RK6
replacement swivel outlet (BL062, BL064)	BL005
ball valve shaft seal kit	BL-RK4
complete ball nozzle seal kit	BL-RK10
optional check valve 5 PSI spring kit	BL-RK11
standard check valve 3 PSI cartridge kit	BL-RK12



BL072NS

#### Repair Kits for Super Ball Nozzle (BL920)

Description	Part #
inlet swivel grease nipple kit (optional)	SWMF-RK1
inlet swivel seal and wear kit	SWMF-RK22
complete inlet swivel rebuild kit	SWMF-RK32
2" FNPT replacement inlet swivel	SWMF-RK42
1-1/2" FNPT replacement inlet swivel	SWMF-RK52
complete ball nozzle seal kit	BL-RK102
optional check valve 5 PSI spring kit	BL-RK112
standard check valve 3 PSI cartridge kit	BL-RK122
replacement trigger kit	BL-RK13



BL920

S



### Gravity Utility Nozzles

**Application**

- For use with 12 volt pumps and gravity flow fittings in economy fuel dispensing applications

**Feature**

- Manual operation (non-automatic)

**Specification**

- Working pressure: 25 PSI

**Approval**

- UL Listed

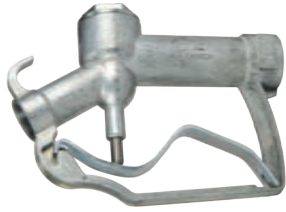

900



900W34S



900B

Female NPT Inlet	Outlet Type	Die Cast Zinc Aluminum Part #
1"	1" female UNS	900 <sup>1</sup>
	1" straight spout	900S
	1" bent spout	900B
	3/4" straight spout	900W34S
	3/4" bent spout	900W34B
3/4"	3/4" straight spout	900S34 <sup>2</sup>
	3/4" bent spout	900B34 <sup>2</sup>

<sup>1</sup> Nozzle body only (no spout)

<sup>2</sup> 3/4" nozzle inlet uses 1" x 3/4" reducer bushing, supplied

**Replacement Parts**

Description	Part #
3/4" replacement straight spout	234-80-4
3/4" replacement bent spout	234-80-5
1" replacement straight spout	875-4
1" replacement bent spout	875-5
trigger	900TK
plunger and valve assemblies, cap, O-ring	900SK

### Pressure Nozzles for Bulk Delivery

**Features**

- Manual operation (non-automatic) for high pressures and fuel flow up to **100 GPM**
- Easy opening dash pot design with shockless closing
- Detachable trigger ratchet, packing gland, and seal
- Bronze trigger



114DNS

Female NPT Inlet	Outlet Type	GPM @ 10 PSI	Aluminum Part #
1-1/4"	1-1/4" female NPT	80	114DNS
	1-1/4" spout		114D
1-1/2"	1-1/2" female NPT	100	112DNS
	1-1/2" spout		112D

**Replacement Parts**

Description	Part #
aluminum replacement spout for 114D	1143A
aluminum replacement spout for 112D	1125A
main and secondary poppets, cap O-ring, valve stem	112DSK
main and secondary poppets, cap O-ring, valve stem assembly and packing, sleeve stem packing and nut	114DSK

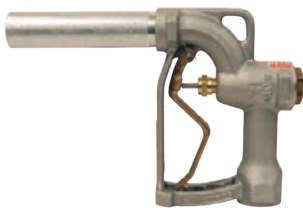

114D

S

## Large Capacity Low Pressure / Gravity Nozzle

### Application

- For low pressure/gravity applications

### Feature

- Rapid flow due to 1-1/4" oversize design

### Specification

- Maximum operating pressure: 25 PSI

Female NPT Inlet	Outlet Type	Aluminum Part #
1-1/4"	1-1/4" spout	1250-94



### Repair Kits

Description	Part #
plunger, O-rings, valve seal, valve base, valve plate	1250SK

## Diesel and Gasoline Nozzle Accessories

### Materials

- Body: aluminum
- Brass hex nut prevents galling in the nozzle
- Seals: F-7036 Viton®
- Retainer: nylon cord

Size	Description	Part #
1-1/2" x 1-1/2"	single plane hose swivel (male adapter x male NPT)	DAWSCL15
2" x 2"		DAWSCL2



### Hose Shank Hose Swivels

**Application**

- For use with petroleum and home heating oil hose

**Feature**

- Prevents hose twisting or kinking



Male NPT	Shank Size	Bronze Part #
1-1/2"	1-1/2"	1565U
Repair Kit		
Description	Part #	
replacement seal kit and retaining ring	1500SK	

### Heavy Duty Hose Swivels

**Features**

- Heavy duty internal thrust bearing and anti-friction seal design ensures swiveling at -40°F (-40°C)
- Can be lubricated without disassembly by using the optional grease nipple kit below

**Specification**

- Male NPT x female NPT threaded connections



Male NPT	Female NPT	Bayloy Part #
1-1/4"	1-1/4"	SWMF125
1-1/2"	1-1/2"	SWMF150
2"	2"	SWMF200
Repair Kits		
Description	Part #	
inlet swivel grease nipple kit (optional)	SWMF-RK1	
inlet swivel seal and wear kit	SWMF-RK22	
complete inlet swivel rebuild kit	SWMF-RK32	
2" FNPT replacement inlet swivel	SWMF-RK42	
1-1/2" FNPT replacement inlet swivel	SWMF-RK52	

### Dixon® MannTek Hose Swivels

**Features**

- Allows the hose to relax to its natural rest position while allowing freedom of movement without adding torque stress at the point of connection
- Simple design, low maintenance - consists of two body halves, ball bearings, and a washer
- FKM seals standard, Chemraz® and Kalrez® optional; contact Dixon®

**Specifications**

- Working pressure: 150 PSI
- Maximum temperature: 300°F (149°C)
- Male NPT x female NPT threaded connections



Size	316 Stainless Steel Part #	Aluminum Part #
3/4"	HS075SS	HS075AL
1"	HS100SS	HS100AL
1-1/2"	HS150SS	HS150AL
2"	HS200SS	HS200AL
3"	HS300SS	HS300AL
4"	HS400SS	HS400AL

S

## Dixon® Diesel and Gasoline Nozzle Accessories

### Single Plane Hose Swivels

#### Materials

- Body: aluminum
- Brass hex nut prevents galling in the nozzle
- Seals: F-7036 Viton®
- Retainer: nylon cord

Size	Part #
3/4" x 3/4"	DAWS34
1" x 1"	DAWS10
1-1/4"	DAWS1414
1-1/2" x 1-1/4"	DAWS1514
1-1/2"	DAWS15
2"	DAWS22



### Multi-Plane Hose Swivels

#### Features

- Brass male end will not gall in nozzle castings
- Dual O-rings seal with all fuels
- Sleeve gives smooth seal surface - no leaks
- Internal nylon retainer cord secures firmly but allows free rotation

#### Materials

- Body: machined aluminum casting
- Male end: machined brass bar stock
- Sleeve: machined brass bar stock

Size	Part #
3/4" male NPT x 3/4" female NPT	DAC3434
1" male NPT x 3/4" female NPT	DAC1034
1" male NPT x 1" female NPT	DAC1010



### Breakaways

#### Features

- Unique ball valves seal both ends when separated
- Design provides consistent and reliable performance
- Lightweight
- Easy to repair

#### Materials

- Body: aluminum
- Break rings (2): brass
- Seals: F-7036 Viton®

#### Approval

- 3/4" UL Listed

Size	Separation Force (Lbs)	Part #
3/4"	325	DAB34
1"	325	DAB1



### Breakaways

#### Application

- Provides breakaway protection for high capacity fueling operations such as truck and bus terminals, mining, off-road fueling, and fuel oil delivery

#### Materials

- Body: nickel plated aluminum
- Brass break rings: 4 total in 1-1/4" and 1-1/2"; 6 total in 2"
- Seals: F-7036 Viton®
- Check valve - PTFE ball seals both ends when separated

Size	Separation Force in Lbs.	Part #
1-1/4"	600	DAB14
1-1/2"	600	DAB15
2"	800	DAB2



## FuelMaster™ Diesel Nozzles

### Application

- Truck stops and terminal operations (not designed for use with gravity flow tanks, small 12 volt or AC utility pumps, farm or consumer pumps) 

### Features

- High flow capacity
- Micro-touch valve provides smooth operation and exceptional flow control
- Roto-matic latch pin provides positive auto shut-off
- Pure PTFE packing eliminates stem leaks
- Easy to change 'locknut style' spout assembly
- Green scuff guard

### Optional Features

- UL Listed versions
- UL listed for use with Gas 10% Ethanol blend and diesel
- Super tough nylon trigger hold-open clip
- 'No pressure, no flow' (NPNF) safety valve prevents the trigger from being held open if pressure is not present

### Materials

- Body and spout: aluminum
- Body caps: zinc
- Seals: FKM
- Poppet disk: FKM
- Stem packing: PTFE
- Hand-guard and trigger hold open clip: super tough nylon
- Trigger: steel
- Snap-on cover: plastic
- Scuff guard: vinyl

### Features

- With trigger hold-open clip
- Non-UL Listed nozzles

NPT Inlet	Spout Outlet	Approximate Flow Rate at 20 PSI (GPM)	Part #
1"	1-3/16"	35	DFN100HF
		45	DFN100SF



DFN100HF

### Features

- With trigger hold-open clip
- With 'no pressure, no flow' safety valve

### Approval

- UL Listed nozzle 

NPT Inlet	Spout Outlet	Approximate Flow Rate at 20 PSI (GPM)	Part #
1"	1-3/16"	35	DFN100HF-NPNF
		45	DFN100SF-NPNF

### Feature

- Without trigger hold-open clip

### Approval

- UL Listed nozzle 

NPT Inlet	Spout Outlet	Approximate Flow Rate at 20 PSI (GPM)	Part #
1"	1-3/16"	35	DFN100HF-NC
		45	DFN100SF-NC



DFN100SF

S



## Big Mouth™ Diesel Nozzles

### Application

- Truck stops (not designed for use with gravity flow tanks, small 12 volt or AC utility pumps, farm or consumer pumps)



### Features

- Lightweight but strong
- Micro-touch valve provides smooth operation and exceptional flow control
- Roto-matic latch pin provides positive auto shut-off
- Pure PTFE packing eliminates stem leaks
- Super tough nylon hand guard
- Snap-on handle cover makes changing scuff guards easy
- Yellow scuff guard

### Optional Features

- UL listed versions
- UL listed for use with gas 10% Ethanol blend and diesel
- Super tough nylon trigger hold-open clip
- 'No pressure, no flow' (NPNF) safety valve prevents the trigger from being held open if pressure is not present

### Materials

- Body and spout: aluminum
- Body caps: zinc
- Seals: FKM / nitrile
- Poppet disk: FKM
- Stem packing: PTFE
- Trigger: steel
- Snap-on cover: plastic
- Scuff guard: vinyl

### Features

- With trigger hold-open clip
- Non-UL listed nozzles

NPT Inlet	Spout Outlet	Approximate Flow Rate at 20 PSI (GPM)	Part #
1"	1-1/8"	27	DFN100

### Features

- With trigger hold-open clip
- With 'no pressure, no flow' safety valve

### Approval

- UL listed nozzle



NPT Inlet	Spout Outlet	Approximate Flow Rate at 20 PSI (GPM)	Part #
1"	1-1/8"	27	DFN100-NPNF



DFN100

### Feature

- Without trigger hold-open clip

### Approval

- UL listed nozzle



NPT Inlet	Spout Outlet	Approximate Flow Rate at 20 PSI (GPM)	Part #
1"	1-1/8"	27	DFN100-NC



DFN100-NC



## Farm and Consumer Nozzles

### Application

- Small 12-volt or AC utility pumps, farm or consumer pumps (not designed for use with gravity flow tanks)



### Features

- Micro-touch valve provides smooth operation and exceptional flow control
- Pure PTFE stem packing eliminates leaks
- Heavy duty, strong, secure hook makes it easy to hang the nozzle on the pump
- Roto-matic latch pin provides positive auto shut-off
- Smartguard snap-on scuff guard

### Materials

- Body and spout: aluminum
- Body caps: zinc or nylon
- Seals: FKM
- Poppet disk: FKM
- Stem packing: PTFE
- Hand-guard and trigger hold open clip: super tough nylon
- Trigger: steel
- Snap-on cover: plastic
- Scuff guard: vinyl

### Optional Features

- UL listed versions
- Super tough nylon trigger hold-open clip
- 'No pressure, no flow' (NPNF) safety valve prevents the trigger from being held open if pressure is not present

### Features

- With trigger hold-open clip
- Non Underwriters Listed nozzle

NPT Inlet	Spout Outlet	Approximate Flow Rate at 20 PSI (GPM)	Scuff Guard Color	Service	Part #
3/4"	13/16"	18	black	gasoline	DN7UOBF
	15/16"	23	green	diesel	DN7LOBF
1"	1-1/8"	27	yellow	diesel	DFN100F <sup>1</sup>

<sup>1</sup> Hand-guard and rear back clip: super tough nylon



1" diesel nozzle

### Features

- With trigger hold-open clip
- With 'no pressure, no flow' safety valve

### Approval

- Underwriters Listed nozzle



NPT Inlet	Spout Outlet	Approximate Flow Rate at 20 PSI (GPM)	Scuff Guard Color	Service	Part #
3/4"	13/16"	18	black	gasoline	DN7UOBF-NPNF
	15/16"	23	green	diesel	DN7LOBF-NPNF
1"	1-1/8"	27	yellow	diesel	DFN100F-NPNF



3/4" gasoline nozzle

### Feature

- Without trigger hold-open clip

### Approval

- Underwriters Listed nozzle



NPT Inlet	Spout Outlet	Approximate Flow Rate at 20 PSI (GPM)	Scuff Guard Color	Service	Part #
3/4"	13/16"	18	black	gasoline	DN7UOBF-NC
	15/16"	23	green	diesel	DN7LOBF-NC
1"	1-1/8"	27	yellow	diesel	DFN100F-NC



3/4" diesel nozzle

### Fuel Nozzle Part Number Cross Reference

Dixon®	M. Carder	OPW	Emco	Husky	Catlow
DN7UOBF	N7UOBF	1AF-40FS	A2501F	XSF-33704	NENLF
DN7LOBF	N7LOBF	11APF-40FS	A2501LF	---	NELF

S

### DEF Automatic Shutoff Nozzle

**Application**

- Designed for diesel exhaust fluid applications

**Materials**

- Spout: stainless steel
- Wetted parts: stainless, acetal, PTFE
- Seal: FKM-A

**Specification**

- Maximum operating pressure: **20 PSI**
- Aluminum body double coated inside and out with PTFE baked on at **500°F (260°C)**



BSP Inlet	Spout Outlet	Approximate Flow Rate at 20 PSI (GPM)	Part #
3/4"	13/16"	18	DEFN075

### High Flow Fueller 100™ Nozzles

**Applications**

- For fueling trucks, buses, off-road equipment, and fuel oil delivery
- *These nozzles are not to be used with gravity flow tanks*



**Features**

- Machined grooves in the spout are designed to hold nozzle more securely in the fill pipe
- High flow, heavy duty automatic nozzle



NPT Inlet	Spout Outlet	Approximate Flow Rate at 30 PSI (GPM)	Part #
1-1/4"	1-3/8"	75	DNOG5-NL <sup>1</sup>
		75	DNOG5
---		DNOG5PL	
1-1/2"		75	DNOG6
		---	DNOG6PL

<sup>1</sup> Is a 1-1/4" nozzle without the locking handle



## Dixon® MannTek Full Flow Ball Valves

### Features

- High flow rate; low pressure drop
- Spindle can be disassembled even when ball valve is installed
- Two ports - one inlet and one outlet

### Materials

- Wetted parts are aluminum and stainless steel
- FPM seals

### Specifications

- Working pressure: **150 PSI** at ambient temperature **70°F (21°C)**
- Standard valve ports - female NPT, socket weld for Schedule 40 pipe and grooved
- Optional ports include DN flange, butt weld, and 150# flange; contact Dixon for details



### One-Way Full Flow Ball Valve Female NPT

Size	Aluminum Part #
2"	1WAYBV200
3"	1WAYBV300
4"	1WAYBV400



### One-Way Full Flow Ball Valve Socket Weld

Size	Bore	Aluminum Part #
2"	2.390"	1WAYBV200SW
3"	3.530"	1WAYBV300SW



### One-Way Full Flow Ball Valve Grooved

Size	Aluminum Part #
2"	1WAYBV200VIC
3"	1WAYBV300VIC

## Dixon® MannTek Full Flow Ball Valves

### Features

- High flow rate; low pressure drop
- Spindle can be disassembled even when ball valve is installed
- Three ports - one inlet and two outlets, valve directs the flow from the inlet to either of the two outlets
- Commonly used for switching compartments or tanks

### Materials

- Wetted parts are aluminum and stainless steel
- FPM seals

### Specifications

- Working pressure: **150 PSI** at ambient temperature **70°F (21°C)**
- Standard valve ports - female NPT, socket weld for Schedule 40 pipe, and grooved
- Optional ports include DN flange, butt weld, and 150# flange; contact Dixon for details

#### Two-Way Full Flow Ball Valve Female NPT

Size	Aluminum Part #
2"	2WAYBV200
	2WAYBV200-SH
3"	2WAYBV300
4"	2WAYBV400



2WAYBV200-SH

#### Two-Way Full Flow Ball Valve Socket Weld

Size	Bore	Aluminum Part #
2"	2.390"	2WAYBV200SW
3"	3.530"	2WAYBV300SW



#### Two-Way Full Flow Ball Valve Grooved

Size	Aluminum Part #
2"	2WAYBV200VIC3
3"	2WAYBV300VIC3



## Betts Wet-R-Dri™ Butterfly Valves

**Application**

- Designed for handling liquid, gaseous, or dry products

**Features**

- Has a positive stop in the open and closed position
- Detent spring and ball assist in holding the disc in the open and closed position
- Drilling fits TTMA recommended standards
- Opens by turning hand 1/4 turn counter clockwise

**Specification**

- Temperature range: 0°F to 400°F (-18°C to 204°C)

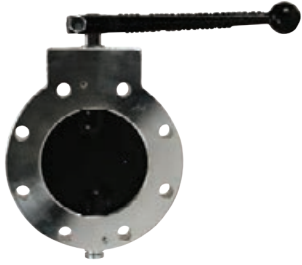

**Manual**

Size	Maximum Working Pressure PSI	Extruded aluminum body with FKM-B disc Part #
2"	75	WD201ALVB
3"		WD301ALVB
4"		WD401ALVB
5"		WD501ALV
6"		WD601ALV
8"		WD801ALV



**Metering**

Size	Maximum Working Pressure PSI	Extruded aluminum body with FKM-B disc Part #
2"	75	WD206ALVB
3"		WD306ALVB
4"		WD406ALVB
5"		WD506ALV
6"		WD606ALV
8"		WD806ALV

**Replacement Handle**

Part #	Extruded aluminum body with FKM-B disc Part #
28957ALEY	replacement handle for 2", 3", 4", and 5" manual handle valves
25933AL	replacement handle for 6" and 8" manual handle valves
28981ALEY	replacement handle for 2", 3", 4", and 5" metering handle valves
26287AL	replacement handle for 6" and 8" metering handle valves

NOTE: For flange dimensions, diagrams and additional information please reference [dixonvalve.com](http://dixonvalve.com).

<b>Rapp-it Repair Kit.....</b>	<b>1054</b>	<b>Accessories (cont.) .....</b>	<b>1063 - 1066</b>
Rapp-it pipe repair kit display .....	1054	Safety tag .....	1065
<b>Thread Tape and Sealant.....</b>	<b>1055 - 1056</b>	Safety tape .....	1065
PTFE tape .....	1055	Stretch straps .....	1066
American made (purple) .....	1055	Pick head fire axe .....	1066
Industrial (white) .....	1055	<b>Hose and Cable Protection.....</b>	<b>1067 - 1070</b>
Stainless steel (gray) .....	1055	Flame retardant product.....	1067
Industrial heavy duty (pink) .....	1055	Standard product .....	1067
For LP gas (yellow) .....	1055	Fire jacket .....	1068
Thread sealant paste .....	1056	Fire jacket tape .....	1068
Joint sealant gasket material.....	1056	Non adhesive fire tape .....	1068
Leak detector.....	1056	Fiberglass sleeving .....	1069
<b>Glass End Caps.....</b>	<b>1057</b>	Kevlar® protective sleeves .....	1069
<b>Topping Gun.....</b>	<b>1057</b>	Nylon protective sleeves - MSHA accepted .....	1069
<b>Sprays and Gels .....</b>	<b>1057 - 1058</b>	Spring guard .....	1070
Food grade penetrating oil .....	1057	Continuous spring guard .....	1070
PurGel klear .....	1058	GSM ball-joint armored hose assemblies.....	1070
Food grade anti-seize .....	1058		
Stainless Steel cleaner and polish.....	1058		
<b>Coupling Inserters.....</b>	<b>1059</b>		
Coupling inserter for large hose.....	1059		
Coupling inserter with 5 ton ram.....	1059		
<b>Hose Racks .....</b>	<b>1059</b>		
<b>Testing Equipment .....</b>	<b>1060 - 1062</b>		
Hand hydrotest pump .....	1060		
Electric test pump .....	1060		
Hydrostatic test pumps .....	1060		
Pneumatic test pump .....	1060		
Hydrostatic test pump accessories.....	1061		
Sprinkler system gauges (UM-393).....	1062		
Line test gauges.....	1062		
Three way gauge valve .....	1062		
PITOT gauge .....	1062		
Sprinkler line tester .....	1062		
<b>Accessories .....</b>	<b>1063 - 1066</b>		
Dixon® coupling lubricant .....	1063		
WD-40 smart straw .....	1063		
Dixon soft hose mallet .....	1064		
Dixon hose knife .....	1064		
Diameter tape .....	1064		
Screw pitch gauge .....	1064		



## Rapp-it Pipe Repair Kits

### Applications

- On-site emergency pipe repair in varied industrial applications: mining, processing, oil and gas, petrochemical, manufacturing, marine, and agricultural industries for use with steel, poly, PVC, copper, and concrete

### Sizes

- 2" x 12', 3" x 12', 4" x 12', 4" x 16', 4" x 30'

### Features

- No mixing or measuring required; easy to apply
- Quickly contains leaking substances, keeping a workplace safe
- Tenacious bond: 5 to 10 min.; functional cure: approx. 30 min.
- One product that can be used on a vast array of pipe sizes, shapes, and materials
- Suitable for use on acid lines, gas, most diluted chemicals, sea water, fuels, and oil
- Chemical resistance: resistant to hydrocarbons, ketones, esters, alcohols, halocarbons, aqueous salt solutions, dilute acids/bases
- Suitable for wet or dry pipe: apply under fresh and saltwater

### Materials

- Bandage: woven fiberglass
- Resin: water-activated polyurethane resin

### Specifications

- Pressure resistance up to **360 PSI (2,500kPA)**
- Shore D hardness at full cure (24 hours): 80 durometer
- Lap shear tensile strength on steel (1" x 1" x 1/16") 400kg (**6.2MPa**)
- Compressive strength **8,000 PSI (55 MPa)**
- Temperatures:  
 Continuous **-40°F to 250°F (-40° to 121°C)**  
 Intermittent **-40°F to 300°F (-40° to 149°C)**  
 Heat resistance: **300°F (150°C)**

### Approval

- NATO Certification 4730-66-1257893



Size	Description	Part #
2" x 12'	kit includes woven fiberglass bandage infused with water-activated resin and a 90 mm stick of Rapp-it steel putty	RAP122
3" x 12'		RAP123
4" x 12'		RAP124
4" x 16'		RAP164
4" x 30'		RAP304

## Rapp-it Pipe Repair Kit Display

### Features

- Rapp-it pipe repair kit not included
- Displays up to six Rapp-it repair kits
- Display box must be assembled by customer



Size	Description	Part #
9-1/2" L x 11-1/2" W x 16" H	display includes box, 30 full-color repair kit product flyers, and one pipe sample; Repair kit product is not included, see display fill	RAPDISPLAY
---	display fill includes (2) repair kits of each size (10 kits total); display not included	RAPDISPLAYFILL



### American Made PTFE Tape (Purple)

**Features**

- Superior quality
- Not for use in oxygen applications



**Specifications**

- Temperature range: -450°F to 500°F (-268°C to 260°C)
- Thickness: 3.5 mil (0.0035 mm)

Size	Length	Part #
1/2"	520"	TTPM50-520
	700"	TTPM50-700
	1429"	TTPM50-1429
3/4"	520"	TTPM75-520
	700"	TTPM75-700
	1429"	TTPM75-1429
1"	520"	TTPM100-520
	700"	TTPM100-700
	1429"	TTPM100-1429



### Industrial PTFE Tape (White)

**Feature**

- Not for use in oxygen applications

**Specifications**

- Thickness: 3.5 mil (0.0035 mm)
- Temperature range: -212°F to 500°F (-136°C to 260°C)

Size	Length	Part #	Optional Qty
1/2"	260"	TTA50	550
	520"	TTB50	500
	1296"	TTC50	250
3/4"	260"	TTA75	350
	520"	TTB75	350
1"	520"	TTB100	250

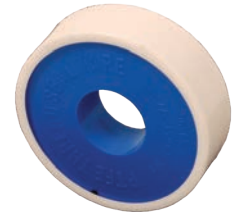

### Stainless Steel PTFE Tape (Gray)

**Application**

- Useful on stainless steel threaded joints or connections

**Features**

- Not for use in oxygen applications
- PTFE with nickel added, nickel acts like a ball bearing
- Made in the U.S.

**Specifications**

- Thickness: 4 mil
- Temperature range: -450°F to 550°F (-268°C to 288°C)

Size	Length	Part #	Optional Qty
1/2"	260"	TTA50SS	10



### Industrial Heavy Duty PTFE Tape (Pink)

**Feature**

- Not for use in oxygen applications

**Specifications**

- Thickness: 4 mil
- Temperature range: -400°F to 500°F (-240°C to 260°C)

Size	Length	Part #	Optional Qty
1/2"	540"	TTBP50	500



### PTFE Tape for LP Gas (Yellow)

**Feature**

- Not for use in oxygen applications

**Specifications**

- Thickness: 4 mil
- Maximum temperature: 500°F (260°C)

**Approval**

- Underwriters Listed

Size	Length	Part #	Optional Qty
1/2"	260"	TTA50LP	500



### Thread Sealant Paste



**Application**

- Do not use with oxygen



**Specification**

- Temperature range: -300°F to 500°F (-184°C to 260°C)

Size	Part #	Optional Qty
1/4 pint	LCTS14	24
1/2 pint	LCTS1	24
1 pint	LCTS2	12
1 quart	LCTS3	12

### Joint Sealant Gasket Material

**Features**

- GORE-TEX interchangeable
- Form-in-place expanded PTFE gasket material with adhesive backing
- Manufactured from 100% virgin PTFE
- Unaffected by all common chemicals (pH from 0-14)
- Unlimited shelf life
- Resilient with low cold flow
- Requires less force than standard gasket materials
- Made in the USA
- Larger spools are available; consult Dixon® for price and availability



**Specifications**

- Pressure range: vacuum to 3000 PSI
- Temperature range: -450°F to 600°F (-268°C to 316°C)

**Approval**

- FDA compliant #21CFR177.1550

Size	Length	Part #
1/4"	20'	LCJS4-20
1/4"	50'	LCJS4-50
3/8"	25'	LCJS6-25
1/2"	15'	LCJS8-15
3/4"	15'	LCJS12-15

### Leak Detector

**Application**

- Detects leaks by forming bubbles which remain for up to ten minutes

**Features**

- Will not cause corrosion or deterioration
- Color: fluorescent yellow
- Non-toxic, non-freezing

**Specification**

- Temperature range: -7°F to 180°F (-20°C to 82°C)

**Approval**

- Meets Federal specification MIL-L-25567-C



Size	Part #	Case Qty
8 oz.	LCLD	24

T

### Sight Glass End Caps - B5416MP

**Feature**

- For use on any line with a clamp and gasket

**Specifications**

- Maximum temperature: 150°F (66°C)
- Maximum operating pressure: 100 PSI

Tube O.D.	A (in)	B (in)	C (in)	D (in)	Acrylic Plastic Part #
1" - 1-1/2"	1.98	1.72	1.68	.50	B5416MP-A100150
2"	2.52	2.22	2.19	.50	B5416MP-A200
2-1/2"	3.05	2.78	2.71	.50	B5416MP-A250
3"	3.58	3.28	3.22	.50	B5416MP-A300
4"	4.68	4.34	4.26	.50	B5416MP-A400
6"	6.57	6.18	6.13	.50	B5416MP-A600
8"	8.57	8.17	8.22	.50	B5416MP-A600

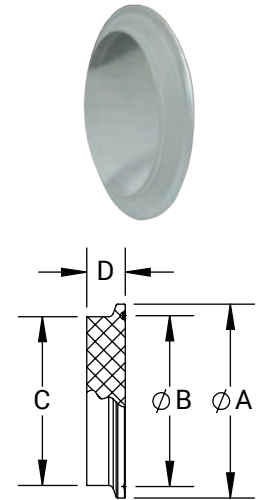

### Topping Gun - BTG

**Features**

- Squeeze handle for easy opening and control
- Spring loaded trigger for positive shutoff

**Materials**

- 304 stainless steel
- Seals and gaskets: EPDM

**Specifications**

- 1/2" female NPT inlet
- 3/4" O.D. tube outlet

A (in)	B (in)	C (in)	D (in)	Part #
8.094	3.38	4.75	4.56	BTG-G50

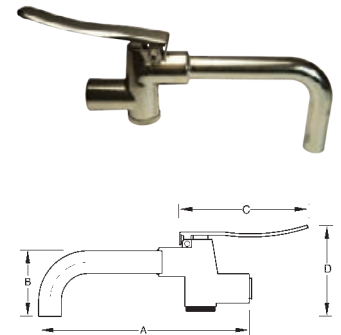

#### Repair Kits

Description	Part #
replacement Handle	BTG-HANDLE
repair kit - 1pc each - spring, piston, piston gasket (1/2" EPDM), plunger, plunger O-ring (nitrile rubber), cap O-ring (I.D. 17.0mm t 2.0mm nitrile rubber)	BTG-KIT

NOTE: Engineering dimensions are available upon request. Specifications are subject to change without notice.

### Jax Food Grade Penetrating Oil

**Features**

- NSF H1 registered for incidental food contact
- Colorless, odorless, and tasteless
- Quickly frees corroded parts
- Protects metal from corrosion
- Lubricates moving parts

Description	Part #
16 fl.oz. trigger spray bottle	LUP0-16



### PurGel Klear



**Features**

- Pure white, FDA approved kosher petrolatum for use as a release agent
- Use for any assembly, barrier or release applications holding O-rings, gaskets, coating cutting blades, or augers

**Approval**

- Meets FDA 21 CFR Part 172: Food Additive Permitted for direct addition to food for human consumption and Part 178: Indirect Food Additives

Description	Part #
8 oz. squeeze tube	LUPG-08

### Food Grade Anti-Seize



**Features**

- Non-toxic and non-drying
- Lubricates threads
- Forms leak-proof seals
- Prevents corrosion
- Resists water and steam

**Approval**

- NSF H1 registered for incidental food contact

Description	Part #
8 oz. bottle with brush-top cap	LUAS-08

### Stainless Steel Cleaner and Polish



**Features**

- Repels water – beads up like wax
- Provides high-gloss protective shield
- Dissolves tarnish
- Rubs in completely, with no dust or residue

**Approval**

- A7 Registered for use in federally-inspected facilities

Description	Part #
14 oz. aerosol can	LUCP-14

NOTE: All products shipped with MSDS (Material Safety Data Sheets)

## Coupling Inserters for Large Hose

### Size

- Inserts 4", 5", 6", 8", 10", and 12" couplings

### Features

- Includes CI96AH pump (shown below)
- Portable
- Coupling inserter pusher plates (not shown) must be purchased separately

Part #	
CI9	

Hose I.D.	Part #
4" - 5"	45CIPUSH
6" - 8"	68CIPUSH
10" - 12"	1012CIPUSH



## Coupling Inserters

### Application

- For insertion of hose shanks into hose with a 2-3/4" to 7-1/4" O.D.

Description	Part #
inserter with <b>10,000 PSI</b> hand pump and 5 ton ram	CI96
inserter with <b>10,000 PSI</b> air/hydraulic pump and 5 ton ram	CI96AH
small jaws for 1" to 2-3/4" O.D. hose	CI9311SML

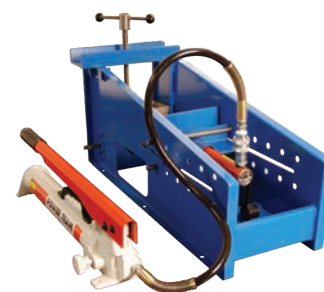

CI96



CI96AH

## Hung Up On Dixon® Hose Racks

### Application

- Can be used for fire or water hose

### Features

- 5 pre-drilled 5/16" mounting holes for easy mounting
- Two racks can be bolted face to face to create extra hose capacity

### Material

- Aluminum

Description	Dimensions	Weight (lbs.)	Part #
single hose rack	19-1/2" x 6" x 9-3/16"	3.4	DHR1
double hose rack	19-1/2" x 12" x 9-3/16"	7.1	DHR2



### Hand Hydrotest Pump



**Application**

- Designed for use in testing pipe lines, pressure tanks, and pressure vessels

**Feature**

- Uses check valves, which are more efficient and longer lasting than poppet systems

**Material**

- Stainless steel piston

**Specifications**

- Cylinder displacement: 1.37 cu. in.
- 0 -1000 PSI pressure gauge, 10' high pressure hose and quick disconnect coupler included
- Piston: 7/8" with 2" stroke
- Working pressure: 1000 PSI at 70°F (21°C)

NPT Inlet	NPT Outlet	Aluminum Part #
1/2"	1/2"	HHTP

### Hydrostatic Test Pumps

#### Electric Test Pump



**Features**

- 110 volt Portable Hydrostatic Electric Pump - Model (ETP)
- Quick connect garden hose coupler for water supply line available

**Specifications**

- 3000 PSI maximum test pressure
- 1.3 GPM fill rate (at 60 PSI inlet water pressure)
- 1/2" x 25' intermediate hose with brass straight-thru quick coupler x NPSM swivel connection
- 1/2" brass straight-thru plug on pressure outlet
- 0 – 3000 PSI back mount liquid filled pressure gauge

Part #
ETP

#### Pneumatic Test Pump

**Features**

- Stainless interior
- Air gauge for quick, easy adjustment of maximum test pressure
- High pressure test gauge
- Filter/regulator for clean, dry air to ensure long life of unit
- On - off valve for air input
- 15' of hose included
- Easy to use: portable hand cart mount or stationary wall mount available
- Use of coalescing filter and water filter recommended for prolonged pump life

**Specifications**

- 5.5 GPM fill rate
- Test pressure: 0 to 1500 PSI



Hand Cart Mount Part #	Wall Mount Part #
PTP	PTP-WM

T

## Hydrostatic Test Pump Accessories

### Application

- Cost effective, pre-assembled caps or plugs allow quick set up for testing hoses

### Feature

- Caps and plugs equipped with 1/2" brass straight-through plug for quick attachment to the intermediate hose on the test pump (pneumatic test pump) and bleed-off valve

### Cam & Groove Test Caps for Male Adapters

Size	Iron / Steel Part #
1"	ID100TC
1-1/2"	ID150TC
2"	ID200TC
3"	ID300TC
4"	ID400TC



### Cam & Groove Test Plugs for Female Couplers

Size	Iron / Steel Part #
1"	IA100TP
1-1/2"	IA150TP
2"	IA200TP
3"	IA300TP
4"	IA400TP



### Female NPT Test Caps

Size	Iron / Steel Part #
1"	NPT100TC
1-1/2"	NPT150TC
2"	NPT200TC
3"	NPT300TC
4"	NPT400TC



### Male NPT Test Plugs

Size	Iron / Steel Part #
1"	100TP
1-1/2"	150TP
2"	200TP
3"	300TP
4"	400TP



### Bleed-off Valve

Part #
IBV50BOV



### FRL Attachment Accessories

Description	Part #
3/8" Wilkerson modular coalescing filter (automatic drain)	M16-03A
3/8" Wilkerson modular coalescing filter (manual drain)	M16-03M
modular sleeve needed to connect M16-03A or M16-03M	GPA-95-292



M16-03A





### Sprinkler System Gauge (UL-393)



**Application**

- Specifically designed for the fire sprinkler industry

**Size**

- 1/4" NPT lower mount

**Features**

- Bourdon tube pressure gauges with black polycarbonate case
- Snap-in clear polycarbonate window, 4" face
- White aluminum dial with stop pin, black and red markings
- Black aluminum non-adjustable pointer

**Specification**

- Temperature range: -40°F to 140°F (-40°C to 60°C)

**Approvals**

- ASME B40.1 Grade B (+ 3/2/3% accuracy)
- UL Listed and FM Approved for fire sprinkler service

Type	Part #
water (0-300 PSI)	SWG300-4

### Line Test Gauges



**Application**

- Used for testing static or flowing pressures in hoses or nozzles

**Features**

- Rocker lug swivel
- Other sizes and threads are also available; contact Dixon®

**Specifications**

- Supplied with 0-300 PSI glycerine-filled 3-1/2" diameter gauge
- Freeze proof to -40°F (-40°C)

NST (NH) Thread	Hardcoated Aluminum Part #
1-1/2"	ALTG150F
2-1/2"	ALTG250F

### Three Way Gauge Valve



**Application**

- Permits checking or replacing a gauge without shutting down the whole line

**Material**

- Disc: rubber

NPT Thread	Working Pressure (PSI)	Brass Part #
1/4"	175	TWGV25

### PITOT Gauge



**Feature**

- Supplied with handle grip, case, and fire stream/friction loss data

**Specification**

- Liquid-filled gauge: 0-160 PSI is standard, other pressures available; contact Dixon

Part #
PG8083

### Sprinkler Line Tester



**Application**

- Installs on the last sprinkler head on system branch lines and controls water flow for flushing or testing the system

Inlet	Outlet	Brass Part #
1" female NPT	1" male NPSH	SLT10050



### Dixon® Coupling Lubricant

**Application**

- For use in assembly operations involving natural or synthetic rubber or plastic. Also an excellent lubricant when rubber or plastic needs to be cut, machined, pressed, turned, trimmed, or ground

**Features**

- Biodegradable lubricant for coupling shanks, O-rings, hoses, sleeves, rubber washers, and grommets
- Once coupling lubricant dries, slipping action goes away



Size	Part #
1 liter	DCL20
4 liters	DCL80

### WD-40 Smart Straw

**Features**

- Permanently attached straw
- Flip up for a precision spray; flip down for regular spray action
- Sold in case quantities only
- Should not be used as a lubricant for coupling shanks 



Size	Part #	Case Qty
11 oz.	WD40	12



### Dixon® Soft Hose Mallet



**Application**

- Soft mallet for pounding metal objects without damaging them

**Features**

- Head material is firmly attached to strong shaft-handle and will not crack
- Length: 23"
- Weight: 10 lbs.

---

**Part #**

DCM1

### Dixon Hose Knife



**Application**

- For fast cutting of rubber hose and belting

**Feature**

- Guard protects hand while cutting

---

**Part #**

DRK15

### Diameter Tape



**Application**

- 6' tape for quickly finding the outside diameter of any cylindrical object

**Features**

- Converts circumference to O.D. at the measured point
- ABS case

---

**Part #**

DDT1

### Screw Pitch Gauge



**Application**

- Used to determine threads per inch

**Feature**

- 30 leaves

---

**Stainless Steel**

**Part #**

TPG

### Safety Tag

**Application**

- Dixon® strongly recommends the use of a safety tag or warning label on all hose assemblies



**Feature**

- Sold in quantities of 100 only

Length	Width	Part #
5"	2-3/8"	DWL100



**WARNING!!**

- Worn-out hose fittings should be replaced
- Loose clamps on hose can be dangerous
- Bolt type clamps should be retensioned regularly
- For extra safety, retaining devices such as clips, chains, or cables must be used

### Safety Tape

**Application**

- Dixon strongly recommends the use of a safety tag or warning label on all hose assemblies



**Feature**

- Length of tape - 55 yards, approximately 255 warnings

Length	Part #
1-1/2"	DSTW



**WARNING!!**

- Worn-out hose fittings should be replaced
- Loose clamps on hose can be dangerous
- Bolt type clamps should be retensioned regularly
- For extra safety, retaining devices such as clips, chains, or cables must be used



### Stretch Straps

**Features**

- Durable tie down straps
- Length does not include S-hooks

**Materials**

- Made of EPDM
- S-hooks are steel



Length	Part #
10"	SSE10
15"	SSE15
21"	SSE21
31"	SSE31
41"	SSE41



**WARNING!!**

Failure to comply with this warning may result in serious damage and/or personal injury. Maximum end to end safe stretch = 150% of length

- Do not exceed maximum safe stretch
- Inspect before each use. Do not use if strap is cut, cracked, or abraded
- Inspect hooks for damage and/or wear. Replace if needed
- Protect strap from sharp edges or heat
- Wear eye protection during use
- Do not use this product as the primary tie down
- Refer to federal or state regulations for proper tie down methods

### Pick Head Fire Axe



**Size**

- 36" hickory handle

**Feature**

- Red trim

**Approval**

- Listed in the minimum requirements approval guides for outfitting hose houses and hose cabinets by insurance underwriters



Description	Part #
6 lb. axe	PHFA6
axe brackets	PHFA-B-A

## Spiral Hose and Cable Protection

### Application

- Used in mining, quarrying, forestry, offshore industries, and most hydraulic hose applications

### Features

- Crush and high abrasion resistance
- Virgin high density polyethylene
- Chemical and UV ray resistant
- Self-lubricating to reduce hose wear
- Easy to install on-site
- Smooth radius on all edges
- Can be used on single or multiple hose bundles
- Spiral guard I.D. is equal to the guard at rest
- Sold in coil lengths only

### Flame Retardant Product

### Features

- Flame retardant, self extinguishing, anti static
- Color: black

### Specification

- Temperature range: -148°F to 262°F (-100°C to 128°C)

### Approval

- Approved by MSHA #1C-282

Nominal I.D.	Coil Length	Part #
.50"	66'	FRSGX16
.62"	66'	FRSGX20
.875"	66'	FRSGX25
1.00"	66'	FRSGX32
1.50"	66'	FRSGX40
1.75"	66'	FRSGX50
2.00"	66'	FRSGX63
2.63"	66'	FRSGX75
3.00"	66'	FRSGX90
4.00"	40'	FRSGX110



### Standard Product

### Feature

- Not flame retardant

### Specification

- Temperature range: -40°F to 240°F (-40°C to 115°C)

Nominal I.D.	Coil Length	Part #
.50"	66'	NFSGX16
.62"	66'	NFSGX20
.875"	66'	NFSGX25
1.00"	66'	NFSGX32
1.50"	66'	NFSGX40
1.75"	66'	NFSGX50
2.00"	66'	NFSGX63
2.63"	66'	NFSGX75
3.00"	66'	NFSGX90
4.00"	33'	NFSGX110
4.57"	40'	NFSGX125
5.00"	27'	NFSGX140
5.87"	20'	NFSGX160 <sup>1</sup>



<sup>1</sup> Stock quantity only

NOTE: Additional sizes available; contact Dixon®.

### Fire Jacket for Hose

**Application**

- Used to protect hose and hose assemblies, tubing, piping, wiring, and cables from high temperatures, direct flame, or molten splash

**Size**

- Supplied in 50' lengths

**Features**

- Helps maintain line temperature and reduce environmental overheating and overcooling
- Sleeving slides easily over hose and expands to go over fittings
- Resistant to hydraulic fluids and lubricating oil
- Iron oxide red color
- Made in USA

**Material**

- Compounded silicone rubber coating over fiberglass

**Specification**

- Temperature range: -65°F to 500°F (-54°C to 260°C)

**Approvals**

- Completely non-asbestos, REACH - ROHS compliant
- Meets flammability requirements of UL 94 HB and UL 94 V-0



Nominal I.D.	Part #
1/4"	0610-4
3/8"	1010-6
1/2"	1310-8
5/8"	1610-10
3/4"	1910-12
7/8"	2210-14
1"	2510-16
1-1/4"	3210-20
1-1/2"	3810-24
1-3/4"	4510-28
2"	5110-32
2-1/2"	6410-40
3"	7610-48
4"	10210-64

### Fire Jacket Tape

**Application**

- Used to seal the ends of fire jackets to prevent fraying and fluid wicking

**Features**

- Completely non-asbestos
- Iron oxide red color
- Made in USA

**Specification**

- Temperature range: -45°F to 380°F (-45°C to 200°C)



Size	Length	Silicone Rubber Part #
1"	12 yards	FTH100

### Non-Adhesive Fire Tape

**Features**

- Fluid resistant to hydraulic fluids and lubricating oils
- Should be installed in a spiral wrap utilizing 30% to 50% overlap
- Iron oxide red color
- Made in USA

**Material**

- Fiberglass coated silicone rubber

**Specification**

- Temperature range: -65°F to 500°F (-54°C to 260°C)



Width	Length	Fiberglass Coated Silicone Rubber Part #
3"	50'	4055-3

T

### Fiberglass Slewing

**Features**

- Braided from texturized E-glass filament yarns. Untreated tubing is flexible and expands to cover changing diameters
- Supplied in a continuous length of 100'
- Made in the USA

**Specifications**

- Thermal insulation protection in applications with service temperatures up to **1000°F (538°C)**
- 1/16" wall thickness

Nominal I.D.	Fiberglass Part #
1/4"	LW04200
3/8"	LW06200
1/2"	LW08200
5/8"	LW10200
3/4"	LW12200
7/8"	LW14200
1"	LW16200
1-1/4"	LW20200
1-1/2"	LW24200
2"	LW32200
2-1/2"	LW40200
3"	LW48200
3-1/2"	LW56200
4"	LW64200



### Kevlar® Protective Sleeves

**Features**

- Braided, cut-resistant 100% genuine Kevlar fiber sleeve provides excellent flexibility
- Provides protection for hydraulic hoses, full lines, wires, cables, and many other systems
- 3000 denier ballistic grade Kevlar; nonirritating fiber
- Made in the USA

**Specification**

- Working temperature: continuous **320°F (160°C)**, short term **570°F (300°C)**

Sleeve I.D.	100' spool Part #
1/2" (13 mm)	KS08200
3/4" (19 mm)	KS12200
1" (25 mm)	KS16200
1-1/4" (32 mm)	KS20200
1-1/2" (38 mm)	KS24200
1-3/4" (44 mm)	KS28200
2" (51 mm)	KS32200
2-1/2" (64 mm)	KS40200
3" (76 mm)	KS48200
3-1/2" (89 mm)	KS56200
4" (102 mm)	KS64200



### Nylon Protective Sleeves - MSHA Accepted

**Features**

- Woven tubular sleeving, for use as a protective covering on hydraulic and industrial hose
- Tight weave of seamless tubular sleeving helps dispense the flow of fluid in a ruptured hose
- Not continous roll/has splices

**Approval**

- MSHA accepted, withstands temperatures up to **275°F (135°C)**, passes flammability tests

Nominal I.D.	Outside Flat	100' rolls Part #	300' rolls Part #
0.90"	1.50"	DHS90-100	DHS90-300
1.00"	1.66"	DHS100-100	DHS100-300
1.13"	1.88"	DHS106-100	DHS106-300
1.25"	2.13"	DHS122-100	DHS122-300
---	---	---	---
1.42"	2.50"	DHS142-100	DHS142-300
---	---	---	---
1.78"	2.88"	DHS175-100	DHS175-300
1.91"	3.00"	DHS181-100	DHS181-300
2.18"	3.63"	DHS219-100	DHS219-300
2.38"	3.88"	DHS238-100	DHS238-300
2.65"	4.25"	DHS263-100	DHS263-300
2.86"	4.75"	DHS288-100	DHS288-300
3.65"	5.88"	DHS366-100	DHS366-300

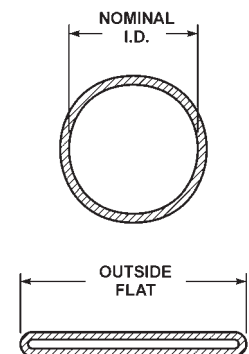

## Spring Guard

### Application

- Protects hose against the effects of flexing at its most vulnerable point - immediately behind the coupling

### Features

- Optional end tang allows end guard to be secured under a clamp or ferrule
- Wire fits most hose O.D.s from 1/2" to 3-1/4." Contact Dixon® for custom sizes or lengths



### With Tang

Guard I.D.	Wire Gauge	Overall Length	Tang Length	Approx. # of Coils/Ft.	Galvanized Steel Part #	304 Stainless Steel Part #
3/4"	0.175	12"	1"	33	SEGC1-0.75-12	SEGS1-0.75-12
1"	0.175	12"	1"	33	SEGC1-1.00-12	SEGS1-1.00-12
1-1/4"	0.175	14"	2"	39	SEGC1-1.25-14	SEGS1-1.25-14
1-1/2"	0.175	14"	2"	39	SEGC1-1.50-14	SEGS1-1.50-14
1-3/4"	0.175	16"	2"	44	SEGC1-1.75-16	SEGS1-1.75-16
2"	0.280	16"	2"	44	SEGC1-2.00-16	SEGS1-2.00-16
2-1/2"	0.280	18"	2"	50	SEGC1-2.50-18	SEGS1-2.50-18
3"	0.280	18"	2"	50	SEGC1-3.00-18	SEGS1-3.00-18

### Without Tang

Guard I.D.	Wire Gauge	Overall Length	Approx. # of Coils/Ft.	Galvanized Steel Part #	304 Stainless Steel Part #
3/4"	0.175	12"	33	SEGC0-0.75-12	SEGS0-0.75-12
1"	0.175	12"	33	SEGC0-1.00-12	SEGS0-1.00-12
1-1/4"	0.175	14"	39	SEGC0-1.25-14	SEGS0-1.25-14
1-1/2"	0.175	14"	39	SEGC0-1.50-14	SEGS0-1.50-14
1-3/4"	0.175	16"	44	SEGC0-1.75-16	SEGS0-1.75-16
2"	0.280	16"	44	SEGC0-2.00-16	SEGS0-2.00-16
2-1/2"	0.280	18"	50	SEGC0-2.50-18	SEGS0-2.50-18
3"	0.280	18"	50	SEGC0-3.00-18	SEGS0-3.00-18



## Continuous Spring Guard

### Application

- Protects hose from external abrasion and helps resist over flexing

### Features

- Fits tight to hose reducing the potential for snagging
- Contact Dixon at 888.226.4673 for custom lengths or sizes



Guard I.D.	Wire Gauge	Overall Length	Approx. # of Coils/Ft.	Galvanized Steel Part #	304 Stainless Steel Part #
3/4"	0.175"	25'	33'	CWG-C-0.75-25	CWG-S-0.75-25
1"	0.175"	25'	33'	CWG-C-1.00-25	CWG-S-1.00-25
1-1/4"	0.175"	25'	33'	CWG-C-1.25-25	CWG-S-1.25-25
1-1/2"	0.175"	25'	33'	CWG-C-1.50-25	CWG-S-1.50-25
1-3/4"	0.175"	25'	33'	CWG-C-1.75-25	CWG-S-1.75-25
2"	0.280"	25'	33'	CWG-C-2.00-25	CWG-S-2.00-25
2-1/2"	0.280"	25'	33'	CWG-C-2.50-25	CWG-S-2.50-25
3"	0.280"	25'	33'	CWG-C-3.00-25	CWG-S-3.00-25

## GSM Ball-Joint Armored Hose Assemblies

### Application

- Includes but not limited to: water cooling hose, oxygen supply hose, hydraulic hose, natural gas hose, black liquor hose, steam hose

### Sizes

- 1/4" through 16" bore
- Lengths to 120'

### Features

- Extremely flexible armor protects from heat, slag splash, and harsh environments
- Temperature rating depends on specific applications; consult Dixon
- A variety of end connections are available. Contact Dixon at 888.226.4673

### Materials

- Armor: galvanized steel or stainless steel
- Wide selection of inner hoses specific to the demands of the application are industrial, hydraulic, stainless steel, or PTFE

### Specification

- Heat resistant insulation to 1000°F



T



**Pressure Washer Display .....1072 - 1076**

E-series hydraulic couplings.....1073  
 Pressure washer display blue bins .....1073  
 Swiveling quick couplings .....1074  
 Fixed quick coupling plugs.....1074  
 Quick connect spray nozzles.....1074  
 Multi-pack quick connect nozzles.....1074  
 Turbo nozzles .....1075  
 Pressure washer spray nozzles.....1075  
 Pressure spray gun - anti-fatigue .....1075  
 Pressure spray gun - molded grip extension .....1076  
 Poster.....1076  
 Sign holder.....1076  
 End cap sign.....1076  
 Shelf graphic .....1076

**Garden Hose Display .....1077 - 1082**

GHT ball valve.....1078  
 Quick connects.....1078  
 Short shank fittings.....1078  
 Menders.....1078  
 Sweeper nozzle .....1078  
 Adjust-A-power nozzle .....1078  
 Twist nozzle.....1079  
 Insulated water nozzles.....1079  
 Filter washers.....1079  
 Black SBR washer .....1079  
 Female GHT adapter.....1079  
 Hydrant adapters - pin lug .....1079  
 Y coupler.....1080  
 Y valve.....1080  
 Plain hose nozzles .....1080  
 GHT 4-valve manifold.....1080  
 Constant flow nozzle displays .....1080  
 Worm gear clamps .....1081  
 Rubber vinyl garden hose .....1081  
 Contractors EPDM water hose.....1081  
 Poster.....1082  
 Sign holder.....1082  
 End cap sign.....1082  
 Shelf graphic .....1082

**Pneumatic Display.....1083 - 1089**

B07 carded miniature filter/regulators .....1084  
 F07 carded miniature filter .....1084  
 R07 carded miniature regulator .....1084  
 L07 carded miniature lubricator.....1084  
 Heavy-duty tire pressure gauge .....1085  
 Tire inflator chuck .....1085

Dual foot tire pressure gauge.....1085  
 Professional tire pressure gauge .....1085  
 Male NPTF x hose barb.....1085  
 5-Part kit DF-series industrial 1/4" body x 1/4" thread .....1086  
 2-Part kit M-series ARO 1/4" body x 1/4" thread .....1086  
 2-Part kit J-series automotive 1/4" body x 1/4" thread.....1086  
 2-Part kit DF-series industrial 1/4" body x 1/4" thread .....1086  
 Non-safety rubber tip blow gun.....1087  
 Air chief safety blow gun .....1087  
 3 in 1 manifold.....1087  
 Pinch-on clamp service kit .....1087  
 ABS standard dry gauges kit-retail package .....1088  
 Polyurethane air hose.....1088  
 Coil-chief self-storing air hose.....1088  
 Polyurethane self-storing air hose .....1088  
 Air tool lubricants.....1089  
 Poster.....1089  
 Sign holder.....1089  
 End cap sign.....1089  
 Shelf graphic .....1089

**Hydraulic Display .....1090 - 1093**

HT-series .....1091  
 AG-series .....1091 - 1093

**Outside Air Display .....1094 - 1101**

Air King® safety clip .....1095  
 Air King lanyard .....1095  
 Air King washers .....1095  
 Soft seat safety pop-off valve .....1095  
 Steel 3500 male nipples .....1095  
 Dix-lock® seal kit.....1095  
 Dual-lock seal kit .....1095  
 Air King .....1096  
 Air King clamps .....1096  
 Boss ground joint couplings with female spud.....1097  
 Boss clamps.....1097  
 Dix-lock coupler.....1098  
 Dix-lock plug .....1098  
 Dual-lock coupler .....1098  
 Dual-lock plug.....1098  
 Safety check valves .....1099  
 King cable® .....1099  
 In-line lubricators .....1100  
 Air tool lubricants.....1100  
 Anti-freeze lubricants.....1100  
 Safety vented ball valves.....1101  
 Whip hose .....1101  
 Sign holder.....1101  
 End cap sign.....1101



## Pressure Washer Display

The pressure washer display offers a wide variety of nozzles for different types of angles and sprays. This display is easily customizable and provides space for additional pressure washing products.



**PART #:** PW-RETAILKIT

**Features**

- Retail packaging
- Retail display signage
- Posters
- Barcodes

NOTE: Shelving is not included.

## E-Series Hydraulic Couplings

### Features

- Couplers have no internal valves, which provides maximum flow with minimum pressure drop
- Contact Dixon® for additional seal material options
- Contact Dixon for pressure ratings and other technical information
- Interchanges with Parker ST, Foster FST, Hansen ST, and Tomco ST couplings
- Do not disconnect with pressure in line 

### Specification

- Nitrile rubber seals are standard, providing a temperature range of -40°F to 250°F (-40°C to 121°C)

### Straight Through Female Threaded Couplers

Body Size	Threads	Required Case Qty	Brass Part #
1/4"	1/4" - 18 NPTF	20	PW-2EF2-B
3/8"	3/8" - 18 NPTF	20	PW-3EF3-B



### Straight Through Male Threaded Couplers

Body Size	Threads	Required Case Qty	Brass Part #
1/4"	1/4" - 18 NPTF	20	PW-2EM2-B
3/8"	3/8" - 18 NPTF	20	PW-3EM3-B



### Straight Through Female Threaded Plugs

Body Size	Threads	Required Case Qty	Steel Part #	Brass Part #
1/4"	1/4" - 18 NPTF	20	---	PW-E2F2-B
3/8"	3/8" - 18 NPTF	20	PW-E3F3	PW-E3F3-B



steel



brass

### Straight Through Male Threaded Plugs

Body Size	Threads	Required Case Qty	Steel Part #	Brass Part #
1/4"	1/4" - 18 NPTF	20	---	PW-E2M2-B
3/8"	3/8" - 18 NPTF	20	PW-E3M3	PW-E3M3-B



steel



brass

### Pressure Washer Display Blue Bins

#### Application

- To be used with E-Series hydraulic couplings above

Description	Required Case Qty	Part #
1 bin with bin labels - 11" x 8" x 7"	1	PW-BLU-BINS
5 bins with bin labels - 7-1/2" x 4" x 3"	1	
5 bins with bin labels- 11" x 4" x 4"	1	



### Swiveling Quick Couplings

**Application**

- For use with AL456 only

**Specifications**

- Working pressure: **3,650 PSI**
- Flow rate: **7.8 GPM**
- Maximum temperature: **300°F (149°C)**



PW-AL450



PW-AL453

Description	Required Case Qty	Part #
1/4" female x 22 mm x 1.5 mm swivel	4	PW-AL450
3/8" female x 22 mm x 1.5 mm swivel	4	PW-AL453

### Fixed Quick Coupling Plugs

**Application**

- For use with AL453 and AL9 only

**Specifications**

- Working pressure: **3,650 PSI**
- Flow rate: **7.8 GPM**
- Maximum temperature: **300°F (149°C)**



PW-AL454



PW-AL456

Description	Required Case Qty	Part #
1/4" female x 22 mm x 1.5 mm male	4	PW-AL454
3/8" female x 22 mm x 1.5 mm male	4	PW-AL456

### Quick Connect Spray Nozzles



Description	Required Case Qty	Part #
1/4" straight through plug inlet, 0° spray angle, size #4, red	4	PW-MSP400
1/4" straight through plug inlet, 15° spray angle, size #4, yellow	4	PW-MSP415
1/4" straight through plug inlet, 25° spray angle, size #4, green	4	PW-MSP425
1/4" straight through plug inlet, 40° spray angle, size #4, white	4	PW-MSP440

### Multi-Pack Quick Connect Nozzles



Description	Nozzles Included	Required Case Qty	Part #
1/4", 65° spray angle, size #40	NZ6540QCS	4	PW-MSP4PAK
1/4", 15° spray angle, size #4, yellow	MSP415		
1/4", 25° spray angle, size #4, green	MSP425		
1/4", 40° spray angle, size #4, white	MSP440		



## Turbo Nozzles

### Features

- 20° spray angle
- Ceramic orifice

### Specification

- Maximum temperature: 212°F (100°C)

Nozzle Size	Description	Orifice	Maximum Working PSI	Required Case Qty	Part #
4.0	1/4" female inlet	1.30 mm	3,700	2	PW-AL-TPR25-30
5.5 - 6.0	1/4" female inlet	1.50 mm	3,700	2	PW-AL-TPR25-50



PW-AL-TPR25-30



PW-AL-TPR25-50

## Pressure Washer Spray Nozzles

Description	Required Case Qty	Part #
1/4" male inlet, 40° spray angle, size #40, brass	4	PW-NZ4040S
1/4" male inlet, 80° spray angle, size #40, brass	4	PW-NZ8040S
1/4" male NPT inlet, 15° spray angle, size 4, steel	4	PW-NZ1504
1/4" male NPT inlet, 25° spray angle, size 4, steel	4	PW-NZ2504
1/4" male NPT inlet, 40° spray angle, size 4, steel	4	PW-NZ4004



## Anti-Fatigue Pressure Spray Gun

### Sizes

- 3/8" female inlet
- 1/4" female outlet

### Feature

- Anti-fatigue pressure compensating design

### Specification

- Temperatures to: 320°F (160°C)

Maximum PSI	GPM	Required Case Qty	Part #
5075	12.0	4	PW-HPSG



### Pressure Spray Gun - Molded Grip Extension



PW-AL323XX



PW-AL324XX

**Application**

- For use with HPSG, HPSGC, HPSGHD, and HPSGW

**Specifications**

- Maximum operating pressure: **5,000 PSI**
- Temperature: **302°F (150°C)**
- Maximum flow rate: **10.5 GPM**

Length	Description	Required Case Qty	Zinc Part #
24"	1/4" male inlet x 1/4" male outlet	4	PW-AL323XX
36"	1/4" male inlet x 1/4" male outlet, 4" space from the end	4	PW-AL324XX



### Poster

Description	Required Case Qty	Part #
pressure washer accessories poster	1	PW-POSTER

### Sign Holder



Description	Required Case Qty	Part #
end cap sign holder	2	SIGNHOLDER

### End Cap Sign



Description	Required Case Qty	Part #
pressure washer accessories end cap sign	1	PW-SIGN

### Shelf Graphic



Description	Required Case Qty	Part #
Dixon® shelf graphic	2	SHELFGRAPHIC



## Garden Hose Display

The garden hose fittings display offers a range of adapters and connectors, along with two styles of hoses. This display reminds your customers of their garden hose-related needs: demanding industrial clean up or at-home projects.



**PART #: GHD-RETAILKIT**

### Features

- Retail packaging
- Retail display signage
- Posters
- Barcodes

NOTE: Shelving is not included.



### GHT Ball Valve

**Specifications**

- Maximum temperature: 140°F (60°C) (hot water)
- Working pressure: 100 PSI

Description	Required Case Qty	Forged Brass Part #
3/4" male GHT x female GHT	6	GHD-500GHV

### Quick Connects

**Feature**

- Easy push-pull ring for long-lasting and quick hose attachments

**Specifications**

- Maximum operating pressure: 150 PSI at ambient temperature 70°F (21°C)
- Maximum temperature: 140°F (60°C)



Description	Required Case Qty	Kit Contains Part #	Brass Part #
complete assembly, female GHT coupler x male GHT plug	6	500QCF (2)	GHD-500QCK
		500QCM	

### Short Shank Fittings

**Features**

- Extended male GHT - deeper thread
- Complete coupling set is shipped unassembled



Hose Size	Required Case Qty	Kit Contains Part #	Brass Part #
3/4"	6	5851212C	GHD-5891212K
		5881212C	

### Menders



Hose Size	Required Case Qty	Kit Contains Part #	Brass Part #
3/4"	6	1781212C (2)	GHD-1781212C

### Sweeper Nozzle



Thread Size	Discharge	Length	Required Case Qty	Brass Part #
3/4" GHT	3/16"	2"	6	GHD-PSN76

### Adjust-A-Power Nozzle

**Application**

- Ideal for patio, auto and boat, driveway, and garden

**Features**

- Produces 50% more power than twist nozzles
- Does not require a washer
- Leave nozzle in the open position when not in use
- Brass construction with stainless steel bearings

**Specification**

- Maximum operating pressure: 100 PSI (water only) at ambient temperature 70°F (21°C)



Thread Size	Required Case Qty	Brass Part #
3/4" GHT	6	GHD-AAPN75GHT





### Twist Nozzle

**Specification**

- Maximum operating pressure **150 PSI** (water only)

Thread Size	Length	Required Case Qty	Extruded Brass Part #
3/4" GHT	4"	6	GHD-500AN4



### Insulated Water Nozzle

**Features**

- Clip locks to any spray pattern
- Industrial strength nylon handle
- Rubber handle guard
- GHT thread-on head
- Heavy-duty brass valve and adjusting nut

**Specification**

- For use with hot water up to **140°F (60°C)**

Thread Size	Required Case Qty	Chrome-Plated Zinc Part #
3/4" GHT	4	GHD-SN75



### Washers

#### Filter Washer

Description	Kit Contains Part #	Required Case Qty	FDA black PVC duro, 70a Part #
304 stainless steel mesh, FDA black 70a duro PVC	5911212F (4)	6	GHD-5911212F



#### Black SBR Washer

ID	OD	Duro	Kit Contains Part #	Required Case Qty	Black SBR Part #
0.63"	1.00"	80	5911212W (4)	100	GHD-5911212W



### Female GHT Adapter

Female x Female	Required Case Qty	Brass Part #
3/4" x 3/4"	6	GHD-5061212C



### Hydrant Adapters - Pin Lug

Female NH	Male GHT	Required Case Qty	Cast Brass Part #
1-1/2"	3/4"	4	GHD-HA1576
2-1/2"	3/4"	4	GHD-HA2576



### Y Coupler



**Specifications**

- Maximum working pressure: **100 PSI**
- Maximum temperature: **140°F (60°C)**

Required Case Qty	Nickel-Plated Brass Part #
6	GHD-500YC

### Y Valve

**Feature**

- Double Y valve, swivel inlet - with Higbee cut threads (capped) to prevent cross threading

**Specifications**

- Maximum temperature: **140°F (60°C)** (hot water)
- Working pressure: **100 PSI**



Description	Required Case Qty	Forged Brass Part #
double male GHT x female GHT	6	GHD-500GHY

### Plain Hose Nozzles

**Feature**

- Finish: satin

**Specification**

- Maximum operating pressure: **100 PSI** (water only) at **70°F (21°C)**



Size	Thread	Overall Length	Orifice	Required Case Qty	Brass Part #
3/4"	GHT	6"	1/4"	6	GHD-BN6

### GHT 4-Valve Manifold

**Feature**

- Swivel inlet

**Materials**

- Forged brass body, TPR handle, POM internal valve NBR seals

**Specifications**

- Maximum temperature: **120°F (49°C)**
- Maximum operating pressure: **100 PSI**



Description	Required Case Qty	Part #
(4) male GH x female GHT	4	GHD-500GH4VBK

### Constant Flow Nozzle Displays

**Application**

- Shatter-resistant and UV-resistant polycarbonate is able to withstand tough environmental conditions

**Features**

- Seals used for true water shut off
- Easy twist spray pattern adjustment
- Sold in case quantity only (25 per case), with display



Thread	45° Spray GPM @ 100 PSI	Color	Required Case Qty	Part #
3/4" GHT	25.1	clear	1	GHD-CNB75GHT-GD
3/4" GHT	25.1	green	1	FNB75GHT-GD



## Worm Gear Clamps

### Features

- Four-piece construction
- Screw design: 5/16" slotted hex head
- Maximum recommended torque: 50 in. lbs.
- All clamps sold 10 per box

### Materials

- Band and housing: SAE 300 series stainless
- Screw: SAE 300 series stainless

### Approval

- Clamp meets SAEJ1508, which supersedes Mil Spec WW-C-440B



Band Width	Hose OD		Kit Contains Part #	Required Case Qty	Part #
	from	to			
1/2"	1/2"	29/32"	HSS8	40	GHD-HSS8
	11/16"	1-1/14"	HSS12	40	GHD-HSS12

## Rubber Vinyl Garden Hose

### Features

- Extra tough, five-ply construction
- Exclusive, soft textured, abrasion-resistant green cover
- Dual reinforced, heavy-duty, flexible kink-resistance
- Combines durability of rubber and easy handling of vinyl
- SEAL-TITE leakproof coupling

### Specifications

- Working pressure: **400 PSI**
- Temperature range: **0°F to 140°F (-18°C to 60°C)**



Size	Required Case Qty	Rubber Vinyl Part #
5/8" x 50'	2	GHD-SGH50

## Contractors EPDM Water Hose

### Features

- Heavy-duty, crush-proof solid brass couplings with wrench grips
- Spiral synthetic cord reinforcement
- Black cover

### Specifications

- Working pressure: **150 PSI**
- Temperature range: **-20°F to 180°F (-29°C to 82°C)**



Size	Required Case Qty	EPDM Part #
3/4" x 50'	2	GHD-CWH50

### Clamp Rack

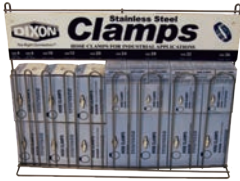

**Size**

- Rack with clamps contains nine clamp sizes with diameter ranges from 7/32" to 2-3/4"

**Features**

- Sign identifies each clamp size and diameter range
- Clamps included are: 30 of part# MH4, 30 of part# MH6, 20 of part# HS10, 20 of part# HS12, 20 of part# HS20, 20 of part# HS24, 20 of part# HS28, 20 of part# HS32, 20 of part# HS36

**Material**

- Top load metal rack made of nickel plated steel rods with enameled steel sign

Description	Required Case Qty	Part #
with 200 clamps	1	CRWC

### Poster



Description	Required Case Qty	Part #
garden hose fittings poster	1	GHD-POSTER

### Sign Holder



Description	Required Case Qty	Part #
end cap sign holder	2	SIGNHOLDER

### End Cap Sign



Description	Required Case Qty	Part #
garden hose fittings end cap sign	1	GHD-SIGN

### Shelf Graphic



Description	Required Case Qty	Part #
Dixon shelf graphic	2	SHELFGRAPHIC

## Pneumatic Display

The pneumatic fittings display offers several parts, from FRLs to quick disconnects, while keeping a single product focus. This display gives your customers the flexibility to choose which fittings work best with their pneumatic systems.



**PART #: PND-RETAILKIT**

### Features

- Retail packaging
- Retail display signage
- Posters
- Barcodes

NOTE: Shelving is not included.

### B07-Series Carded Miniature Filter/Regulators



**Features**

- Relieving type
- 5 micron element
- 1 oz. reservoir
- Push-to-lock adjusting knob
- Supplied with a GC620 gauge
- Bowl guard not available
- Transparent bowl

**Specifications**

- Pressure range: **5-100 PSI**
- Inlet pressure: **150 PSI** maximum
- Maximum temperature: **125°F (52°C)**

Port Size	Flow (SCFM)	Required Case Qty	Automatic Drain Part #	Manual Drain Part #
1/4"	14	4	PND-B07-202AGC	PND-B07-202MGC

### F07-Series Carded Miniature Filters



**Features**

- 5 micron element
- 1 oz. reservoir
- Transparent bowl

**Specifications**

- Inlet pressure: **150 PSI** maximum
- Maximum temperature: **125°F (52°C)**

Port Size	Flow (SCFM)	Required Case Qty	Automatic Drain Part #	Manual Drain Part #
1/4"	24	4	PND-F07-200AC	PND-F07-200MC

### R07-Series Carded Miniature Regulator

**Features**

- Relieving type
- Supplied with a GC620 gauge

**Specifications**

- Pressure range: **5-100 PSI**
- Inlet pressure: **250 PSI** maximum
- Maximum temperature: **150°F (66°C)**



Port Size	Flow (SCFM)	Required Case Qty	With Gauge Part #
1/4"	15	4	PND-R07-200RGC

### L07-Series Carded Miniature Lubricator

**Feature**

- 1 oz. reservoir

**Specifications**

- Inlet pressure: **150 PSI** maximum
- Maximum temperature: **125°F (52°C)**



Port Size	Flow (SCFM)	Required Case Qty	With Transparent Bowl Part #
1/4"	14	4	PND-L07-200AC

SCFM ratings given at 100 PSIG inlet pressure for regulators, 90 PSIG for others.

 FRLs are designed for air service only, unless otherwise indicated.

## Heavy Duty Tire Pressure Gauge

**Size**

- 12" hose with swivel dual foot chuck inflator

**Feature**

- Tapered chuck nut fits wheel cover holes on cars and light trucks

**Specification**

- Calibrated in **2 PSI** increments from **10 to 120 PSI**

Required Case Qty	Part #
3	PND-D101



## Tire Inflator Chuck

**Application**

- For direct connection to live air only

**Features**

- Ball foot chuck
- Features a built-in shutoff valve (will not work on inflator gauges)

**Specifications**

- 1/4" NPT female thread
- Maximum pressure: **150 PSI**

Required Case Qty	Brass Part #
6	PND-D104



## Dual Foot Tire Pressure Gauge

**Feature**

- Heavy-duty hang-up ring

**Specification**

- Calibrated in **2 PSI** increments from **10 to 150 PSI**

Required Case Qty	Part #
6	PND-DFG2



## Professional Tire Pressure Gauge

**Features**

- Permanently lubricated
- Easy to read, dual calibrated (**PSI and kPa**), four-sided nylon indicator bar
- Pocket clip

**Material**

- Body is made of chrome-plated brass; head is chrome-plated zinc

**Specification**

- Calibrated in **1 PSI** increments from **5 to 45 PSI**

Required Case Qty	Part #
6	PND-DFG5



## Male NPTF x Hose Barb

Hose ID	Male NPTF	Required Case Qty	Kit Contains Part #	Brass Part #
3/8"	1/4"	6	1020604C (4)	PND-1020604C



**5 Part Kit DF-Series Industrial 1/4" Body x 1/4" Thread**



Body Size	Threads	Required Case Qty	Kit Contains Part #	Part #
1/4"	1/4" - 18 NPTF	6	D2F2	PND-DQCKIT1
			2FF2-B	
			D2M2 (3)	
1/4"	1/4" - 18 NPTF	6	D2F2	PND-DQCKIT2
			2DF2-B	
			D2M2 (3)	

**2 Part Kit M-Series ARO 1/4" Body x 1/4" Thread**



Body Size	Threads	Required Case Qty	Kit Contains Part #	Part #
1/4"	1/4" - 18 NPT	6	2MF2-B	PND-DQCKIT3
			M2M2	

**2 Part Kit J-Series Automotive 1/4" Body x 1/4" Thread**



Body Size	Threads	Required Case Qty	Kit Contains Part #	Part #
1/4"	1/4" - 18 NPT	6	2JF2-B	PND-DQCKIT4
			J2M2	

**2 Part Kit DF-Series Industrial 1/4" Body x 1/4" Thread**



Body Size	Threads	Required Case Qty	Kit Contains Part #	Part #
1/4"	1/4" - 18 NPTF	6	D2M2	PND-DQCKIT5
			2FF2-B	

**2 Part Kit DF-Series Industrial 1/4" Body x 1/4" Thread**



Body Size	Threads	Required Case Qty	Kit Contains Part #	Part #
1/4"	1/4" - 18 NPTF	6	2FM2-B	PND-DQCKIT6
			D2F2	





### Non-Safety Rubber Tip Blow Gun

The rubber tip will not scratch or mar delicate surfaces. The conical rubber tip can also be used to create a seal between the blow gun and fluid lines (or any other opening). The base of the tip is nickel-plated brass for additional corrosion resistance. *Must be used on air lines having a maximum regulated pressure of 30 PSI in order to comply with OSHA Standard 1910.242 (B). Safety glasses or shield must be worn when using any blow gun.* 

**Features**

- Chrome plated zinc die cast body, nickel plated steel lever, vinyl thumb grip, stainless steel spring, brass valve, nitrile rubber seals, and rubber tip with a nickel plated brass base provide corrosion resistance



Required Case Qty	Part #
6	PND-D201

### Air Chief Safety Blow Gun

The Air Chief safety blow gun is designed to conform to OSHA Standard 1910.242 (B) permitting a maximum of 30 PSI outlet pressure when dead ended based on a maximum of 150 PSI inlet pressure, as well as OSHA Standard 1910.95 regulating occupational noise level exposure. *Safety glasses or shield must be worn when using any blow gun.* 

**Features**

- Recessed internal slotted screw allows easy access to valve assembly for repairs or replacement
- Chrome plated zinc die cast body, nickel-plated steel lever, vinyl thumb grip, stainless steel spring, brass valve, nitrile rubber seals, and nickel plated brass tip combine for corrosion resistance



Required Case Qty	Part #
6	PND-D204-30

### 3 in 1 Manifold

**Features**

- Supplies three air-operated tools from a single hose, permitting use of air by more than one mechanic
- Can be mounted to a pipe at workbench or overhead
- Different tools in the shop use different styles of couplers; mount three different style couplers on one manifold



NPT Inlet (1)	NPT Outlets (3)	Required Case Qty	Aluminum Part #
3/8"	1/4"	6	PND-D3406

### Pinch-On Clamp Service Kit

**Features**

- Plastic kit box contains zinc plated 2-ear clamps: 15 of part #0709, 15 of part #0811, 15 of part #1113, 15 of part #1315, 15 of part #1518, 12 of part #1720, 12 of part #2023, 12 of part #2225, 12 of part #2327, and 1 pair of standard jaw pincers, part# 1098



Required Case Qty	Part #
2	PND-SK1098



### ABS Standard Dry Gauges Kit-Retail Package



Description	Kit Contains Part #	Required Case Qty	ABS Part #
dry gauge center back mount	GC230 (4)	1	PND-GAUGEKIT1
dry gauge lower mount	GL130 (7)		

### Polyurethane Air Hose (fittings included)

**Features**

- Durable and lightweight
- Reinforced braid allows for higher working pressure
- Excellent flexibility
- Oil resistant
- Durometer: Shore A 85



**Specifications**

- Temperature range: -40°F to 155°F (-40°C to 68°C)
- Working pressure: 210 PSI at 70°F (21°C)

Hose ID	Length	Male NPT	Required Case Qty	Polyurethane Part #
1/4"	50'	1/4"	3	PND-450-4S

### Coil-Chief Self-Storing Air Hose (fittings included)

**Feature**

- Supplied with swivel on one end

**Material**

- Nylon construction



Hose ID	Length	Male NPT	Working Pressure (PSI) @ 70°F (21°C)	Required Case Qty	Nylon Part #
1/4"	12'	1/4"	185	3	PND-CC1412

### Polyurethane Self-Storing Air Hose (fittings included)

**Features**

- Extremely flexible; resists kinking
- Impervious to abrasions and oil
- Superior elasticity and coil memory
- Both ends swivel



Hose ID	Length	Male NPT	Working Pressure (PSI) @ 70°F (21°C)	Required Case Qty	Polyurethane Part #
1/4"	25'	1/4"	125	3	PND-PU1425



## Air Tool Lubricants

### Application

- High-grade lubricant prolongs the service life of air tools, cylinders, and accessories

### Features

- #10 weight lubricant
- Prohibits rust and removes moisture as it lubricates
- Non-corrosive, non-reactive, and does not decompose
- Easy pour spout helps prevent costly spills



Size	Required Case Qty	Part #
1 pint	4	PND-DATL016
1 gallon	2	PND-DATL128

## Poster

Description	Required Case Qty	Part #
pneumatic fittings poster	1	PND-POSTER



## Sign Holder

Description	Required Case Qty	Part #
end cap sign holder	2	SIGNHOLDER



## End Cap Sign

Description	Required Case Qty	Part #
pneumatic fittings end cap sign	1	PND-SIGN



## Shelf Graphic

Description	Required Case Qty	Part #
Dixon shelf graphic	2	SHELFGRAPHIC



## Hydraulic Display

The hydraulic display features the most popular poppet and flushface style quick disconnect fittings in an attractive packaging making it easily noticeable.

New

**Back of Package Card**

**RD-4AGSET**

Interchanges with:

Agricultural Interchange - Parker/Pioneer 4000 Series, Parker MS/NV Series - Salfway Series-335 ShurClk II Series

---

Part #: 4AGF4  
Material: Steel  
Thread: NPTF  
Thread Size: 1/2"  
Replaces: Pioneer Part # 4050-4



Part #: AD4F4  
Material: Steel  
Thread: NPTF  
Thread Size: 1/2"  
Replaces: Pioneer Part # 8010-4



©WARNING: Cancer and Reproductive Harm - www.P60Warnings.ca.gov

**DIXON**

**DIXON QUICK COUPLING**  
2925 Chief Court  
Dallas, NC 28034  
dixonvalve.com

**MADE IN THE USA**

QD0001



Competitor Interchange data

Pioneer Part# Replacement

UPC Code

Made in the USA

**PART #: RD-RETAILKIT**

**Features**

- Retail packaging
- Retail display signage
- Posters
- Barcodes

NOTE: Shelving is not included.



### HT-Series ISO16028 Coupler

Body Size	Threads	Required Case Qty	Kit Contains Part #	Part #
1/2"	1/2" F-NPTF	4	4HTF4	RD-4HTF4



### HT-Series ISO16028 Plug

Body Size	Threads	Required Case Qty	Kit Contains Part #	Part #
1/2"	1/2" F-NPTF	4	HT4F4	RD-HT4F4



### HT-Series ISO16028 ORB Coupler

Body Size	Threads	Required Case Qty	Kit Contains Part #	Part #
1/2"	7/8"-14 ORB	4	4HTOF5	RD-4HTOF5



### HT-Series ISO16028 ORB Plug

Body Size	Threads	Required Case Qty	Kit Contains Part #	Part #
1/2"	7/8"-14 ORB	4	HT4OF5	RD-HT4OF5



### AG-Series Coupler and Plug Set

Body Size	Threads	Required Case Qty	Kit Contains Part #	Part #
1/2"	1/2" F-NPTF	4	4AGF4, AG4F4	RD-4AGSET



### AG-Series Coupler

Body Size	Threads	Required Case Qty	Kit Contains Part #	Part #
1/2"	1/2" F-NPTF	4	4AGF4	RD-4AGF4





### AG-Series Push-Pull Ball Coupler and Plug Set

Body Size	Threads	Required Case Qty	Kit Contains Part #	Part #
1/2"	1/2" F-NPTF	4	4AGF4-PS, AG4F4	RD-4AGSET-PS



### AG-Series Poppet Plug

Body Size	Threads	Required Case Qty	Kit Contains Part #	Part #
1/2"	1/2" F-NPTF	4	AG4F4-PV	RD-AG4F4-PV



### AG-Series Ball ORB Plug

Body Size	Threads	Required Case Qty	Kit Contains Part #	Part #
1/2"	3/4"-16 ORB	4	AG40F4	RD-AG40F4



### AG-Series Ball Plug

Body Size	Threads	Required Case Qty	Kit Contains Part #	Part #
1/2"	1/2" F-NPTF	4	AG4F4	RD-AG4F4



### AG-Series Poppet Coupler and Plug Set

Body Size	Threads	Required Case Qty	Kit Contains Part #	Part #
3/8"	3/8" F-NPTF	4	3AGF3-PV, AG3F3-PV	RD-3AGSET-PV



### AG-Series Poppet Coupler and Plug Set

Body Size	Threads	Required Case Qty	Kit Contains Part #	Part #
1/4"	1/4" F-NPTF	4	2AGF2-PV, AG2F2-PV	RD-2AGSET-PV



### AG-Series Dust Plug

Body Size	Color	Required Case Qty	Kit Contains Part #	Part #
1/2"	black	4	4KDP (x2)	RD-4KDP



### AG-Series Dust Cap

Body Size	Color	Required Case Qty	Kit Contains Part #	Part #
1/2"	black	4	K4DC (x2)	RD-K4DC



### AG-Series Dust Plug - Green

Body Size	Color	Required Case Qty	Kit Contains Part #	Part #
1/2"	green	4	4K-G-DP (x2)	RD-4K-G-DP



### AG-Series Dust Plug - Yellow

Body Size	Color	Required Case Qty	Kit Contains Part #	Part #
1/2"	yellow	4	4K-Y-DP (X2)	RD-4K-Y-DP



### Outside Air Display

The outside air display features high demand construction hose couplings, whip hose assemblies, and other accessories.



PART #: OA-RETAILKIT

**Features**

- Retail packaging
- Retail display signage
- Posters
- Barcodes

NOTE: Shelving is not included.





### Air King® Safety Clip

Description	Required Case Qty	Contents	Part #
Air King safety clip, diameter .080"	5	AC1 (25)	OA-AC1



### Air King Lanyard

Description	Required Case Qty	Contents	Part #
Synthetic Air King lanyard 19" long	5	ACL8 (25)	OA-ACL8



### Air King Washers

Description	Required Case Qty	Contents	Part #
Black natural rubber Air King washers	5	AWR4 (10)	OA-AWR4



### Soft Seat Safety Pop-Off Valves

Description	Required Case Qty	Contents	Part #
1/4" MNPT safety pop-off valve, brass, 125 PSI	4	KSV10-125	OA-KSV10-125
1/4" MNPT safety pop-off valve, brass, 150 PSI	4	KSV10-150	OA-KSV10-150



### Steel 3500 Male Nipple

Description	Required Case Qty	Contents	Part #
1/2" barb x 1/2" male NPT 3500 nipple	4	3512	OA-3512



### Dix-Lock® Seal Kit

Description	Required Case Qty	Contents	Part #
Dix-Lock seal kit	5	4N-SKIT (5)	OA-4N-SKIT



### Dual-Lock Seal Kit

Description	Required Case Qty	Contents	Part #
Dual-Lock seal kit	5	4P-SKIT (5)	OA-4P-SKIT



**Air King®**

**⚠ WARNING**

- The use of an Air King safety clip or wire type retainer is necessary to ensure Air King universal couplings will not become accidentally disconnected. This guarantees the fittings are properly connected because the safety pin will not go through the holes in mating flanges until couplings are locked in place. Only one Air King safety clip or wire type retainer is required for each Air King universal coupling.

**Feature**

- Supplied with safety clip and rubber washers, part # AWR4

**Specification**

- Pressure rating: **150 PSI** at ambient temperature **70°F (21°C)**

**Approval**

- Meets pressure requirements as specified in A-A-59553 commercial item description superseding Mil Spec.WWC-633D



**2-Lug Male NPT Ends**

Size	Required Case Qty	Iron Part #
3/4"	6	AM7



**2-Lug Female NPT Ends**

Size	Required Case Qty	Iron Part #
3/4"	6	AM8



**2-Lug Hose Ends**

Size	Required Case Qty	Iron Part #
3/4"	6	AM6

**Air King Clamps**

**Application**

- For use with Air King ends above

**Feature**

- Torque values for clamps are based on dry bolts. The use of lubricant on bolts will adversely effect clamp performance



Hose ID	Hose OD		Required Case Qty	Torque ft. lbs.	Plated Iron Part #
	from	to			
3/4"	1-8/64"	1-20/64"	6	21	A9 <sup>1</sup>

<sup>1</sup> Global investment cast carbon steel

NOTE: Products placed in blue plastic bin with label.

## Boss® Ground Joint Couplings with Female Spud

### Application

- Leakproof seal forms when the metal head of the stem makes contact with the patented polymer seat in the spud

### Features

- Positive metal-to-polymer seal
- Easy to seal

### Specification

- Recommended for steam service up to 450°F (232°C)



Hose Shank x NPT	Required Case Qty	Plated Iron Part #
2"	4	GF81 <sup>1</sup>

<sup>1</sup> Not to be used with #250, #275, or #306 Boss clamps

## Boss Clamps

### ⚠ WARNING

- The bolts used in the Boss interlocking clamps are not standard bolts. They vary from standard bolts in their length, diameter, overall thread length, and material hardness. These bolts can be retorqued, but it is **not** recommended that the bolts or clamps be reused, as they are designed for a single bend only. Dixon® recommends using only factory supplied replacement bolts.
- Torque values for clamps are based on dry bolts. The use of lubricant on bolts will adversely effect clamp performance. *Do not lubricate nuts and bolts.*
- For all Bolt Tightening Sequences, please visit [dixonvalve.com](http://dixonvalve.com)

### Features

- Recommended torque rating in ft. lbs.
- Replacement nuts and bolts are available; contact Dixon for more information

### Specification

- Recommended for steam service up to 450°F (232°C)

### 4-Bolt Type, 2-Gripping Fingers

Hose ID	Hose OD		Required Case Qty	Torque ft. lbs.	Zinc Plated Iron Part #
	from	to			
2"	2-32/64"	2-50/64"	4	60	BU29



NOTE: Products placed in blue plastic bin with label.

**Dix-Lock® Couplers**



Body Size	Thread	Required Case Qty	Part #
1/2"	3/4" barb	5	4NS6



Body Size	Thread	Required Case Qty	Part #
1/2"	3/4"-14 M-NPTF	5	4NM6



Body Size	Thread	Required Case Qty	Part #
1/2"	3/4"-14 F-NPTF	5	4NF6

**Dix-Lock Plugs**



Body Size	Thread	Required Case Qty	Part #
1/2"	3/4"-14 F-NPTF	5	N4F6



Body Size	Thread	Required Case Qty	Part #
1/2"	3/4" barb	5	N4S6-LS



Body Size	Thread	Required Case Qty	Part #
1/2"	3/4" M-NPTF	5	N4M6-LS

**Dual-Lock Couplers**



Body Size	Thread	Required Case Qty	Part #
1/2"	3/4" barb	5	4PS6



Body Size	Thread	Required Case Qty	Part #
1/2"	3/4" M-NPTF	5	4PM6



Body Size	Thread	Required Case Qty	Part #
1/2"	3/4" F-NPTF	5	4PF6

**Dual-Lock Plug**

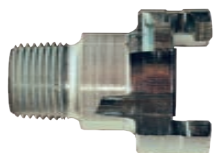

Body Size	Thread	Required Case Qty	Part #
1/2"	3/4" M-NPTF	5	P4M6

NOTE: Products placed in blue plastic bin with label.



### Safety Check Valves

#### Applications

- Used in temporary plant/factory air lines, construction sites, shipyards, or utilities
- Not for use in applications where 100% of the available air is required, i.e. sand blast, pile driving rigs, expansion joint blow down pipes, etc.

#### Features

- High flow valve provides optimum performance
- Controls excess air flow (SCFM) in only one direction
- Automatically senses change in air flow and shuts off the flow in the event of a surge in excess of valve flow rating thus preventing hose whip
- Does not prevent backflow

#### Materials

- Solid brass body and valve
- Stainless steel spring and roll pin

#### Specifications

- Maximum operating pressure: **350 PSI**
- Maximum temperature: **250°F (121°C)**

#### Approval

- Conforms to OSHA regulation 1926.302 (b) (7) requiring a safety device at the source of the air supply and at branch air lines

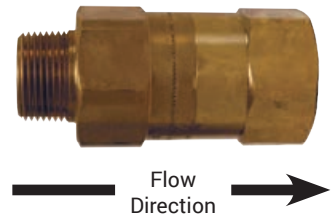

NPT & Hose ID Size	Cut-off Flow Rate (SCFM at 90 PSI)	Required Case Qty	Brass Part #
3/4"	132-148	4	SCVJ6
	160-180		SCVS6

NOTE: Products placed in blue plastic bin with label.

### King Cable®

#### Application

- When hose, couplings, or clamps fail, or there is an accidental separation of the assembly, King safety cables minimize damage to equipment and injuries to operators

#### Features

- Must be installed in the extended position (no slack)
- Cable reaches across hose fittings to provide standby safety for hose
- Spring-loaded loops in the cable ends open easily to pass over the couplings for a firm grip on the hose
- No tools needed - easy to install and remove
- Cables shipped with safety restraint labels attached
- Highly resistant to rust and corrosion
- Hose-to-hose or hose-to-rigid outlet

#### Materials

- Wire rope: galvanized carbon steel
- Ferrules: aluminum
- Springs: galvanized carbon steel

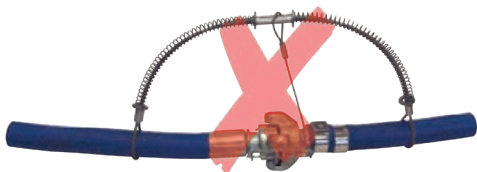

Incorrect installation

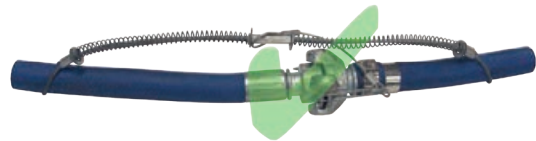

Correct installation

#### Hose-to-Tool Service



Hose end

Tool end

Hose ID	Cable	Length	Maximum Working Pressure (PSI)	Required Case Qty	Steel Part #
1/2" - 1-1/4"	1/8"	20-1/4"	200	4	WSR1

#### Hose-to-Hose Service



Hose end

Hose end

Hose ID	Cable	Length	Maximum Working Pressure (PSI)	Required Case Qty	Steel Part #
1/2" - 1-1/4"	1/8"	20-1/4"	200	4	WB1
1-1/2" - 3"	1/4"	38"	200		WA2



## In-Line Lubricators

### Application

- Protects portable or stationary air tools by efficiently oiling the tool mechanisms; each time an air tool is operated a fine mist of oil is injected into it along with the air from the compressor

### Features

- Installation is recommended within 25' of the tool to be lubricated; refer to the arrow for proper air flow direction
- Transparent sight disc allows visual inspection of oil level
- Oil flow regulated by screwdriver screw adjustment, minimum flow rate is 30 SCFM
- Not recommended for constant flow applications
- For reciprocating tools only
- Type of oil to use: any petroleum-based, non-detergent light weight oil (SAE 10/150SSU) which will readily break up into a mist, i.e., Mobil DTE light or comparable oil. Do not use any synthetic oil or oils containing additives or solvents
- See below for air tool lubricant



NPT Size	Oil Capacity	Maximum Working Pressure at Ambient Temperature (70°F)	Air Flow at 70 PSI	Required Case Qty	Aluminum Part #
1/2"	1.4 fluid ozs.	500 PSI	30 SCFM	3	PL300

NOTE: Products placed in blue plastic bin with label.

## Air Tool Lubricant

### Application

- High-grade lubricant prolongs the service life of air tools, cylinders, and accessories

### Features

- #10 weight lubricant
- Prohibits rust and removes moisture as it lubricates
- Non-corrosive, non-reactive, and does not decompose
- Easy pour spout helps prevent costly spills



Size	Required Case Qty	Part #
1 pint	2	DATL016

## Anti-Freeze Lubricant

### Application

- Winter grade air tool lubricant prevents air line, air tool, and in-line lubricator freeze-up

### Feature

- Can be poured directly into tool or used with air line lubricators

### Specification

- Minimum temperature -45°F (-43°C)



Size	Required Case Qty	Part #
1 pint	2	DATL016W

### Safety Vented Ball Valves

**Application**

- For air service only

**Specification**

- Pressure rating: 0-125 PSI

**Features**

- Blow-out proof stem design
- Adjustable packing gland

**Approval**

- Vent downstream air in accordance with OSHA regulation 1910.147 for pneumatic systems

**Materials**

- Bronze valve
- Chromium plated ball
- RTFE seats and stuffing box ring



Female NPT	Port	Required Case Qty	Bronze Part #
3/4"	standard	3	BBV75LV

NOTE: Products placed in blue plastic bin with label.

### Whip Hose

Description	Required Case Qty	Part #
Whip hose 1/2" x 6', Air King x 7/8" threaded bent stem	1	WH50X6AKBS87

Description	Required Case Qty	Part #
Whip hose 1/2" x 6', Air King x 1/2" threaded bent stem	1	WH50X6AKBS50

Description	Required Case Qty	Part #
Whip hose 3/4" x 6', Air King x 3500 nipple	1	WH75X6AK35



### Sign Holder

Description	Required Case Qty	Part #
end cap sign holder	2	SIGNHOLDER



### End Cap Sign

Description	Required Case Qty	Part #
Outside air end cap sign	1	OA-SIGN



### Blue Bins with Label

Description	Required Case Qty	Contents	Part #
Blue bins with label	1	S-12416 (2), S-13536 (13), S-12414 (5)	OA-BLU-BINS



**Proposition 65 Information ..... 1103**

**Hose and Coupling Safety ..... 1104**

**General Safety Information ..... 1104**

**Safety Is Everyone's Job ..... 1105 - 1107**

Be Safe ..... 1105  
 S.T.A.M.P.E.D. .... 1105  
 Force chart ..... 1106  
 Safety products and recommendations in the DPL..... 1106  
 MSHA regulations ..... 1106  
 OSHA regulations..... 1107

**Value Add Programs..... 1108**

Solutions on Site vans by Dixon®..... 1108  
 Best practices safety assessment..... 1108  
 Hose coupling workshop ..... 1108

**Material Selection ..... 1109 - 1114**

Selecting materials ..... 1109  
 Corrosion resistance ratings ..... 1109 - 1114

**Fraction - Decimal Chart ..... 1115**

**Conversion Constants/Formulas ..... 1116**

Measures of pressure ..... 1116  
 Length conversions constants ..... 1116  
 Weight conversion constants..... 1116  
 Circumference of a circle..... 1116  
 Right cylinder ..... 1116

**Temperature ..... 1117 - 1119**

Temperature conversions..... 1117  
 Steam temperature and pressure conversion guide..... 1118  
 Pressure - temperature ratings ..... 1119

**Air ..... 1120 - 1123**

Air velocity in a pipe ..... 1120  
 Air volume discharged from pipe ..... 1120  
 Boyle's law ..... 1120  
 Air supply requirements..... 1120  
 CFM vs. PSI for nozzles..... 1121  
 Air receiver capacities ..... 1121  
 Air hose friction ..... 1122  
 Max. rec. air flow (SCFM) through ANSI metal pipe ..... 1123  
 Suggested pipe size for compressed air flow ..... 1123

**Water ..... 1124 - 1125**

Water constants and formulas..... 1124  
 Water discharge table..... 1124  
 Conversion table - feet of water to inches of mercury..... 1125  
 Feet head of water to PSI ..... 1125

**Thread Information ..... 1126 - 1131**

Pipe threads ..... 1126  
 NPT vs. BSP (British Standard Pipe) ..... 1126  
 Identifying threads..... 1127  
 Thread types..... 1128  
 Thread chart for hydraulic fittings ..... 1129  
 Fittings size chart ..... 1129  
 Thread dimensions ..... 1130  
 Normal engagement length of NPT thread ..... 1130  
 Thread sealing tips..... 1131

**Flange Dimensions ..... 1132 - 1133**

Flange bolt tightening sequence..... 1132  
 Flange diagrams ..... 1132  
 ANSI flange dimensions ..... 1133

**Pipe Dimensions ..... 1134**

Dimensions of seamless and welded steel pipe  
 ASA-B36.10 and B36.19..... 1134  
 Cross reference from NPS to DN specification..... 1134

**Valve Selection Guides ..... 1135 - 1136**

Valve selection guide..... 1135  
 3-way ball valve flow options ..... 1136

**BPE DT Table Call Out ..... 1137**

**Pipe Gasket Sizing Guide ..... 1138 - 1139**

**Particulate Reference Chart..... 1140**

**Clamp Fittings and Gasket Sizing Guide.....  
 1141 - 1143**





## Proposition 65 Information

As a company that may sell or distribute Dixon Valve & Coupling Company, LLC (“Dixon”) products to California consumers or to other persons or entities that may sell such items to California consumers, Dixon is obligated to notify you of the following:

Dixon is in compliance with the California Safe Drinking Water and Toxic Enforcement Act of 1986 and its supporting regulations (“Proposition 65”), as it provides warnings that comply with a 2015 court-approved settlement. All Dixon products are shipped in cartons with the following warning:

**“WARNING:** This product contains lead, a chemical known to the State of California to cause cancer and birth defects or other reproductive harm.”

If you sell or distribute Dixon products to California consumers, or to other persons or entities that may sell such items to California consumers, in quantities fewer than a full carton, you must provide this warning to each customer, either by labeling each unit with the above warning, by posting a sign at the point of sale, or by another method.

If you sell Dixon products online to California consumers, you should display this warning message on the product display page, by a clearly marked hyperlink on the product display page, or otherwise prominently displayed to the purchaser before the purchaser completes the purchase of the product.

Dixon will defend and indemnify you if there is a claim made under Proposition 65 for listed chemicals being contained in its products, so long as you have provided the warning per the instructions above. If you sell Dixon products without the warnings we have provided, you are at risk of enforcement and significant penalties.

If you would like more information about the chemicals contained in Dixon products, please visit our website at [www.dixonvalve.com](http://www.dixonvalve.com). Many product display pages contain material safety data sheets, which list the chemicals contained in the products and the chemical concentrations.

Dixon couplings, adapters, valves, and connectors made of brass may not be sold to California consumers unless such fittings either contain less than 300 ppm of lead when analyzed pursuant to the EPA test method 3050B or equivalent or they are sold or distributed with a clear, reasonable, and conspicuous warning. So long as it is prominently displayed on the product or the packaging of the product, the above warning complies.

Should you need further explanation or assistance in complying with this notice, please do not hesitate to contact Dixon at [compliance@dixonvalve.com](mailto:compliance@dixonvalve.com).

### Hose and Hose Coupling Safety

**"The very properties that make compressed gases useful in almost every area of modern life can also make them dangerous when mishandled. Years of experience with compressed gases have led to practices and equipment which, if employed, result in complete safety."**<sup>1</sup>

Dixon hose couplings have been carefully engineered to meet specific requirements. If hose or couplings are not used in correct applications or are incorrectly applied, accidents and downtime can result. It is up to the end user to inform the distributor of the application and pressures involved when ordering hose assemblies and it is up to the distributor to supply the right hose and coupling for that application. When in doubt, Dixon is here to help you with a proper coupling recommendation.

- 1. Air hose couplings** - This form of energy can be one of the most dangerous because it is used in so many applications and, when mishandled, can have more serious results than fluids. Air, as a gas, is compressible (fluids press only against hose or vessel walls and lose little volume under pressure). When pressurized air releases suddenly, it does so with explosive force and can cause rapid hose whip, which can do serious physical harm to personnel or damage to nearby objects. This is why the selection of proper hose and couplings for air lines is so important, along with their proper installation and maintenance. Never take for granted that a coupling is installed properly or a clamp fully tightened on an air hose - check it regularly and use safety devices (see paragraph 4).
- 2. Steam and gas** - The same rules apply for steam and gas, but, because these are inherently more hazardous materials, personnel tend to treat hose and couplings on these lines with more respect and care. Checking clamp tightness is very important with steam hose, where it is not unusual for clamps to loosen in service, in which case they must be retightened! Safety devices should also be used (see paragraph 4).
- 3. Fluid hose couplings** - Again, nothing should be taken for granted - in particular, check clamps for tightness each time the lines are used - especially when petroleum products or other hazardous liquids are involved. Large diameter hose, when suspended, can also be quite dangerous if it drops unexpectedly due to a coupling "pull-out" or sudden disconnection. A heavy fitting or clamp, plus the weight of the hose itself falling from any significant height, can cause injuries or damage. Be sure to use safety devices (see paragraph 4).
- 4. All hose assemblies** - All hose assemblies should be treated with respect as potential hazards. Worn-out fittings should be replaced. Retaining devices such as clips, cables, or chains should be used. Clamps should be checked regularly. Under no circumstances should any coupling be disconnected while under pressure, unless the coupling is specifically designed to do so. Disconnecting couplings under pressure could result in serious injury or death and destruction of property and equipment.

<sup>1</sup> "Handbook of Compressed Gases"

### General Safety Information

#### Pressure Ratings

Pressure ratings for couplings, as stated in this catalog, are based upon ambient temperature **70°F (21°C)** applications with true hose I.D., new Dixon supplied couplings, new Dixon supplied clamps, new quality hose, and proper installation by a qualified assembler using Dixon procedures and equipment. In addition, temperature can affect coupling retention. For temperatures other than ambient (**70°F**), contact the hose manufacturer or call Dixon at 800.355.1991.

#### Product Selection

Many of the products in this catalog are used in hose assemblies in a variety of applications. The safety of any hose assembly rests on the proper selection, installation, testing, and use of each product. The safe use of any product in this catalog is dependent upon the correct selection of the hose, fittings, and method of attachment. To ensure such a proper selection, the user must inform the distributor of the application and pressure involved when ordering hose assemblies. The use of S.T.A.M.P.E.D. (Size, Temperature, Application, Media, Pressure, Ends, Dixon) will help in the proper selection of hose assembly components (see page 1105). The selection of couplings and clamping devices is the responsibility of the purchaser or user, based upon the hose manufacturer's recommendations. If the purchaser or user is uncertain about the use or application of a product, Dixon stands ready to provide information, including test results (if available), coupling and clamping recommendations, and other data to help resolve those matters.

#### Installation

To achieve a safe and reliable assembly, proper installation procedures must be followed. Each component of the assembly has a part in determining these procedures. The purchaser or user must follow proper procedures. If the purchaser or user has any questions regarding installation, please contact Dixon®.

#### Testing

Dixon recommends that all hose assemblies be tested in accordance with the hose manufacturer's recommendations.

#### Re-testing and Inspection

Dixon recommends inspection and re-testing of hose assemblies on a regular and consistent basis in accordance with the hose manufacturer's recommendations. The application determines the regularity of the inspection and re-testing schedule. Any worn-out fittings, damaged hoses, or missing safety devices should be replaced immediately. Bolt-style clamps must be checked and retightened on a regular and consistent basis.

All hose assemblies should be viewed as potential hazards. This document is designed to inform and educate anyone who manufactures, specifies, supplies, purchases, assembles, uses, maintains, or tests any hose assembly or its component parts. The proper selection and maintenance of hose, couplings, attachment devices, and accessories is imperative. It is the end user's responsibility to identify to the distributor the application and any special conditions that the hose assembly must meet. It is the distributor's responsibility to supply the proper assembly for the intended application. Accidents and down time may occur if hose assemblies are not properly selected for the specific application. The performance and safety of the assembly is affected by the quality of the individual components. The use of the acronym S.T.A.M.P.E.D. (Size, Temperature, Application, Media, Pressure, Ends, Dixon) will help in the proper selection of the hose assembly components (see below). If anyone is uncertain about the use or application of a product, Dixon can provide test results, coupling and clamping recommendations, and other data to help resolve those matters. Call 800.355.1991 with any questions.

## Be Safe

Hose assemblies must be inspected prior to each use. Worn out fittings, attachment devices, hose, and accessory items must be replaced. Retaining devices (safety devices) such as clips, cables, or chains must be used. Clamps must be checked regularly to the specified torque found in the Dixon literature. Under no circumstance should any coupling be disconnected while under pressure unless the coupling is specifically designed to do so. Disconnecting couplings under pressure could result in serious injury or death, and destruction to property and equipment.

For all hose assemblies in use:

- Beware** - Hose assemblies when used improperly or in the wrong application can be dangerous. The maximum working pressure shown on the hose is not an indication of the working pressure of the assembly. Based on the hose, fittings, and attachment method used, all assemblies should be permanently marked with the designed working pressure and the intended media. The assembly working pressure should be permanently displayed. Hose assemblies must be used for the intended service only. Never alter manufactured product or substitute component parts.
- Eliminate** - Eliminate hazardous conditions by inspecting, maintaining, and testing hose assemblies. Dixon recommends that all hose assemblies be tested in accordance with the hose manufacturer's specifications. The application determines the regularity of the re-testing schedule.
- Secure** - Secure and inspect hose, fittings, clamping devices, and safety accessories before each use. Never take for granted that the coupling or attachment devices are properly installed.
- Always** - Always inspect and re-tighten the bolts of any bolt style clamping device to the manufacturer's torque specifications.
- Fittings** - Hose fittings and clamping devices that are worn out or damaged must be removed from service.
- Educate** - Educate your employees about the proper use, care, and potential hazards of hose assemblies. Take advantage of Dixon's free Hose Assembly Safety Program and the follow up Training Seminar to aid you in setting up your own inspection program. Any questions on applications, use or assembly call 800.355.1991.

## S.T.A.M.P.E.D.

When fabricating and specifying hose assemblies ask the following questions:

- Size:** What is the I.D. (inside diameter) of the hose? What is the O.D. (outside diameter) of both ends of the hose? What is the overall length of the assembly required?
- Temperature:** What is the temperature range of the media (product) that is flowing through the hose assembly? What is the temperature range of the environment that surrounds the outside of the hose assembly?
- Application:** How is the hose assembly actually being used? Is it a pressure application? Is it a vacuum (suction) application? Is it a gravity flow application? Are there any special requirements that the hose assembly is expected to perform? Is the hose being used in a horizontal or vertical position? Are there any pulsations or vibrations acting on the hose assembly?
- Media:** What is the media/material that is flowing through the hose assembly? Being specific is critical. Check for: Abrasive materials, chemical compatibility, etc.
- Pressure:** What is the maximum pressure including surges (or, maximum vacuum) that this hose assembly will be subjected to? Always rate the maximum working pressure of your hose assembly by the lowest rated component in the system.
- Ends:** What couplings have been requested by the user? Are they the proper fittings for the application and hose selected?
- Dixon:** Dixon recommends that, based on the hose, fittings, and attachment method used, all assemblies be permanently marked with the designed working pressure and intended media. Do not use other manufacturers' fittings or ferrules with Dixon products due to the differences in dimensions and tolerances. We also recommend that all hose assemblies be tested frequently. *Be Safe:* Any questions on application, use, or assembly, call 800.355.1991.

**Force Chart**

- For hose I.D.s from 1-1/4" to 12", the force in pounds is greater than the **PSI**.
- Force is the dynamic power which is exported longitudinally through a hose, toward the ends. To arrive at the number of pounds of force exerted, you multiply the area of the I.D. x the working pressure being used.
- Area of a circle= r<sup>2</sup>x π [3.1416]
- Force = Area x Pressure

**Force (In Pounds)**

Hose I.D.	25 PSI	50 PSI	75 PSI	100 PSI	150 PSI	200 PSI	250 PSI	300 PSI	500 PSI	1000 PSI
1/4"	1	2	4	5	7	10	12	15	25	49
3/8"	3	6	8	11	17	22	28	33	55	110
1/2"	5	10	15	20	29	39	49	59	98	196
3/4"	11	22	33	44	66	88	110	133	221	442
1"	20	39	59	79	118	157	196	236	393	785
1-1/4"	31	61	92	123	184	245	307	368	614	1227
1-1/2"	44	88	133	177	265	353	442	530	884	1767
2"	79	157	236	314	471	628	785	942	1571	3142
2-1/4"	123	245	368	491	736	982	1227	1473	2454	4909
3"	177	353	530	707	1060	1414	1767	2121	3534	7069
4"	314	628	942	1257	1885	2513	3142	3770	6283	12566
5"	491	982	1473	1964	2945	3927	4909	5891	9818	19635
6"	707	1414	2121	2827	4241	5655	7069	8482	14137	28274
8"	1257	2513	3770	5027	7540	10053	12566	15080	25133	50266
10"	1964	3927	5891	7854	11781	15708	19635	23562	39270	78540
12"	2827	5655	8482	11310	16965	22620	28274	33929	56549	113098

**Safety Products and Recommendations in the Dixon® Product List**

**Safety is everyone's concern!**

Dixon provides many safety products designed to protect personnel and property. Recommendations and safety warnings are also included for your review.

Hose and coupling safety .....page 1104

S.T.A.M.P.E.D.....page 1105

EZ Boss-Lock handles.....page 67

Cam and groove safety clips .....page 74

Air King® - not to be used for steam statement.....page 180

KingCable® safety cables.....page 1099

Safety shut-off valves, OSHA REG. 1926.302.....page 910

**30 PSI** safety blow guns .....page 277

Safety vented ball valves .....page 877

Safety tags and safety tape.....page 1065

The importance of whip hose statement.....page 179

**Mine Safety and Health Administration (MSHA) Regulations**

30 CFR Sections 56.13021 and 57.13021

Except where automatic shut-off valves are used, safety chains or other suitable locking devices shall be used at connections to machines of high-pressure hose line of 3/4" inside diameter or larger, and between high-pressure hose lines of 3/4" inside diameter or larger, where a connection failure would create a hazard.

30 CFR Section 75.1730

(e) Safety chains, suitable locking devices, or automatic cut-off valves shall be used at connections to machines of high-pressure hose lines of 3/4" inside diameter or larger, and between high-pressure hose lines of 3/4" inside diameter or larger, where a connection failure would create a hazard. For purposes of this paragraph, high-pressure means pressure of **100 PSI** or more.

30 CFR Section 77.412

(d) Safety chains or suitable locking devices shall be used at connections to machines of high-pressure hose line of 1" inside diameter or larger, and between high-pressure hose line of 1" inside diameter or larger, where a connection failure would create a hazard.

The regulations may be viewed in full on the MSHA website, [msha.gov](http://msha.gov). Please check the website for updates.



## OSHA Regulations

### Standards - 29 CFR, 1910.242 (partial):

(b) Compressed air used for cleaning - Compressed air shall not be used for cleaning purposes except where reduced to less than **30 PSI** and then only with effective chip guarding and personal protective equipment.

### Standards - 29 CFR, 1915.131 (partial):

(e) Before use, pneumatic tools shall be secured to the extension hose or whip by some positive means to prevent the tool from becoming accidentally disconnected from the whip.

### Standards - 29 CFR, 1926.302 (partial):

(b)(1) Pneumatic power tools shall be secured to the hose or whip by some positive means to prevent the tool from becoming accidentally disconnected.

(b)(2) Safety clips or retainers shall be securely installed and maintained on pneumatic impact (percussion) tools to prevent attachments from being accidentally expelled.

(b)(3) All pneumatically driven nailers, staplers, and other similar equipment provided with automatic fastener feed, which operate at more than **100 PSI** pressure at the tool shall have a safety device on the muzzle to prevent the tool from ejecting fasteners, unless the muzzle is in contact with the work surface.

(b)(4) Compressed air shall not be used for cleaning purposes except where reduced to **30 PSI** and then only with effective chip guarding and personal protective equipment which meets the requirements of Subpart E of this part. The **30 PSI** requirement does not apply for concrete form, mill scale, and similar cleaning purposes.

(b)(5) The manufacturer's safe operating pressure for hoses, pipes, valves, filters, and other fittings shall not be exceeded.

(b)(6) The use of hoses for hoisting or lowering tools shall not be permitted.

(b)(7) All hoses exceeding 1/2" inside diameter shall have a safety device at the source of supply or branch line to reduce pressure in case of hose failure.

### Standards - 29 CFR, 1926.306:

#### (a) General requirements

(a)(1) Application. This section applies to compressed air receivers and other equipment used in providing and utilizing compressed air for performing operations such as cleaning, drilling, hoisting, and chipping. On the other hand, however, this section does not deal with the special problems created by using compressed air to convey materials nor the problems created when men work in compressed air as in tunnels and caissons. This section is not intended to apply to compressed air machinery and equipment used on transportation vehicles such as steam railroad cars, electric railway cars, and automotive equipment.

#### (a)(2) New and existing equipment.

(a)(2)(i) All new air receivers installed after the effective date of these regulations shall be constructed in accordance with the 1968 edition of the A.S.M.E. Boiler and Pressure Vessel Code Section VIII.

(a)(2)(ii) All safety valves used shall be constructed, installed and maintained in accordance with the A.S.M.E. Boiler and Pressure Vessel Code, Section VIII Edition 1968.

#### (b) Installation and equipment requirements

(b)(1) Installation. Air receivers shall be so installed that all drains, handholes, and manholes therein are easily accessible. Under no circumstances shall an air receiver be buried underground or located in an inaccessible place.

(b)(2) Drains and traps. A drain pipe and valve shall be installed at the lowest point of every air receiver to provide for the removal of accumulated oil and water. Adequate automatic traps may be installed in addition to drain valves. The drain valve on the air receiver shall be opened and the receiver completely drained frequently and at such intervals as to prevent the accumulation of excessive amounts of liquid in the receiver.

#### (b)(3) Gauges and valves.

(b)(3)(i) Every air receiver shall be equipped with an indicating pressure gauge (so located as to be readily visible) and with one or more spring-loaded safety valves. The total relieving capacity of such safety valves shall be such as to prevent pressure in the receiver from exceeding the maximum allowable working pressure of the receiver by more than 10 percent.

(b)(3)(ii) No valve of any type shall be placed between the air receiver and its safety valve or valves.

### Standards - 29 CFR, 1926.603 (partial):

(a)(9) Steam hose leading to a steam hammer or jet pipe shall be securely attached to the hammer with an adequate length of at least 1/4" diameter chain or cable to prevent whipping in the event the joint at the hammer is broken. Air hammer hoses shall be provided with the same protection as required for steam lines.

(a)(10) Safety chains, or equivalent means, shall be provided for each hose connection to prevent the line from thrashing around in case the coupling becomes disconnected.

*The regulations may be viewed in full on the OSHA website, [osha.gov](http://osha.gov). Please check the website for updates.*

### Value Add Programs

#### Solutions on Site Vans by Dixon®



Our Solutions on Site (SOS) vans are outfitted with product samples, videos, literature, and products representative of what Dixon provides to specific markets. Call 800.355.1991 for additional information.

#### Best Practices Safety Assessment

Dixon, in partnership with your industrial hose supplier, is pleased to offer a hose and coupling safety survey of your plant, at no cost to you, to assist in your efforts to make your facility as safe, efficient, and productive as possible.

Today, plant safety is an enormous, ongoing endeavor in which it is impossible to be an expert in every field.

The use of damaged or misapplied hose couplings and related items occurs. To the untrained eye, these hazards may continue to exist until an accident happens, threatening not only plant machinery, but also the well-being of plant personnel.

Our program includes a visual inspection of hose assemblies and related accessories in your plant by trained technicians. A professionally written report containing our observations and recommendations for corrective action is subsequently provided to augment your own ongoing safety program. If desired, photographs of the areas of concern can be supplied with the report. As a follow-up, the program offers an educational hands-on seminar directly relating to the safety concerns in your facility.

Plant safety is coming under increasing scrutiny by various regulatory agencies. Let Dixon trained personnel assist you in establishing and maintaining safety compliance in your plant.

The safety survey report is completely confidential and will only be shown to authorized plant personnel. For more information, please contact Dixon at 800.355.1991.

#### Hose Coupling Workshop

In an effort to provide our customers with information regarding the proper and safe methods of assembling hose and couplings, Dixon offers Hose Coupling Workshops suitable for a company's sales force and shop personnel.

Classes consist of lectures and/or hands-on demonstrations of coupling selection, hose preparation, coupling installation, assembly testing, and maintenance procedures. Morning, afternoon, and all-day classes are available. For more information, please visit [dixonvalve.com/hcw](http://dixonvalve.com/hcw) or call 800.355.1991.

We encourage you to share this information with anyone who may be affected by the selection, installation, maintenance, or use of any hose assembly. Always use quality products to **Be Safe**.

## Material Selection

### Selecting Materials

This information is intended to help make general comparisons between different available materials.

Material	Features and Benefits
Stainless Steel	A corrosion-resistant material that provides high strength at high temperatures, helps prevent contamination of product being transported, maintains cleanliness, and retains a lustrous appearance. Harder than brass. <i>Type 304</i> is a low-carbon chromium-nickel stainless steel. <i>Type 316</i> is similar to type 304, but has a high nickel content as well as a molybdenum for stronger resistance to heat and corrosion. Often used for water, oil, gas, and steam in low- to high-pressure applications.
Brass	Has good corrosion resistance and is less expensive than stainless steel. Is softer and easier to thread than stainless steel and forms tight seals. It can be used interchangeably with copper where heavier walls are required. Found in plumbing and heating application. Also good with oil, natural gas, and air. Resists corrosion from salt water as well as fresh water polluted with waste from mineral acids and peaty soils. Use in low- to high-pressures applications.
Steel	Used in noncorrosive environments. This carbon- and iron-based metal is hard and strong. It is an economical alternative to stainless steel and brass in high-pressure applications. For use with water, oil, gas, and steam in low- to high-pressure applications where corrosion is not a problem.

Product application is based not only on material selection but on design of product for intended use. Please contact Dixon® for selection of the proper fitting for your application.



### Corrosion Resistance of Coupling Material

#### **⚠ WARNING**

The data on the following pages has been compiled from generally available sources and should not be relied upon without consulting and following the specific recommendations of the manufacturer regarding particular coupling materials. This chart is also available under Interactive Tools at [dixonvalve.com](http://dixonvalve.com).

#### Ratings

Metal	Non-Metal	Gasket/Seal Material
1 = Excellent 2 = Good 3 = Fair X = Not Recommended - = Contact Dixon®	A = Acceptable X = Not Recommended - = Contact Dixon®	T = PTFE V = FKM E = EPDM, EPR N = Neoprene B = Nitrile Rubber

- Ratings given are based at **70°F (21°C)**. Chemical compatibility varies greatly with temperature. For applications at temperatures other than **70°F (21°C)**, contact Dixon for recommendations at 800.355.1991.
- Gasket / seal materials are not necessarily listed in order of preference.
- Chemical resistance of a material does not necessarily indicate the suitability of a fitting in a given application due to variables such as improper clamp and coupling application, special hose construction, gasket material, etc.



Special caution should be taken when handling hazardous materials.

**Material Selection**

AGENT	Aluminum	Brass	Bronze	Hastelloy, C-276	Malleable Iron Carbon Steel	Monel	Stainless Steel, 304	Stainless Steel, 316	Nylon	Polypropylene	Seal Material
Acetate Solvents (Crude)	1	X	X	1	2	2	1	1	A	X	T
Acetate Solvents (Pure)	1	1	1	1	X	1	1	1	A	X	T
Acetic Acid (80%)	3	X	X	1	X	1	1	1	X	X	TEVNB
Acetic Acid (50%)	2	X	X	1	X	2	2	1	X	X	TEVNB
Acetic Acid (20%)	2	X	X	1	X	2	2	1	X	X	TEVNB
Acetic Acid (10%)	2	X	2	1	X	2	1	1	X	X	TEVNB
Acetic Anhydride	2	X	2	1	2	2	2	2	X	X	TNB
Acetone	1	2	2	1	2	1	1	1	A	X	TE
Acetylene	1	X	X	2	2	2	1	1	X	X	TEVNB
Alcohols											
Amyl Alcohol	2	2	2	2	2	1	2	2	A	A	TEVNB
Benzyl Alcohol	2	2	2	2	2	1	1	1	X	A	TVB
Butyl Alcohol	1	2	1	2	2	1	1	1	A	A	TEVN
Diacetone Alcohol	1	1	2	1	2	1	2	2	X	A	TE
Ethyl Alcohol	1	2	2	1	2	2	2	2	X	A	TEVNB
Hexyl Alcohol	-	-	-	1	-	-	-	-	A	-	-
Isobutyl Alcohol	-	-	-	-	-	-	-	-	A	-	-
Isopropyl Alcohol	2	2	2	2	2	2	2	2	A	A	TEVNB
Methyl Alcohol (Methanol)	2	2	2	1	2	2	2	2	A	A	TENB
Octyl Alcohol	-	-	-	-	-	-	-	-	A	-	-
Propyl Alcohol	2	2	2	1	2	2	1	1	X	A	TEVNB
Aluminum											
Aluminum Chloride (Aqu.)	X	X	X	1	X	X	X	X	A	A	TEVNB
Aluminum Fluoride (Sat.)	2	-	-	-	X	2	X	2	X	A	TEVNB
Aluminum Nitrate (Sat.)	3	X	-	-	X	-	2	2	A	A	TEVNB
Aluminum Potassium Sulfate (Alum)	2	2	2	2	X	2	X	2	X	A	TEVNB
Aluminum Sulfate (Sat.)	X	X	2	2	X	2	-	2	A	A	TEVNB
Ammonia											
Ammonia Anhydrous	1	X	X	2	1	1	2	1	A	X	TENB
Ammonia Gas	X	X	X	1	1	X	1	1	A	X	TENB
Ammonia Nitrate	-	-	-	-	-	-	-	-	X	-	-
Ammonium											
Ammonium Bifluoride	-	X	-	2	X	2	-	-	X	A	TEVB
Ammonium Carbonate (Sat.)	2	X	X	2	2	2	2	2	A	A	TEVNB
Ammonium Casenate	-	-	-	-	-	-	-	-	A	-	-
Ammonium Chloride (Sat.)	X	X	2	2	X	2	X	X	A	A	TEVNB
Ammonium Hydroxide (Sat.)	2	X	X	2	1	X	2	2	A	A	TEVNB
Ammonium Nitrate	2	X	X	-	X	X	-	-	A	A	TENB
Ammonium Phosphate (10-40%)	X	X	X	-	X	2	1	2	A	A	TEVNB
Ammonium Sulfate (10-40%)	X	X	3	2	X	2	X	2	A	A	TEVNB
Aniline	-	X	2	2	X	2	1	1	X	X	TV
Arsenic Acid	X	X	2	2	X	X	2	2	X	A	TEVNB
Asphalt	-	-	-	-	2	-	-	2	X	X	TV
Barium											
Barium Carbonate (Sat.)	X	2	2	2	2	2	2	2	A	A	TEVNB
Barium Chloride (Sat.)	-	2	2	1	-	2	X	-	A	A	TEVNB
Barium Hydroxide (Sat.)	X	2	X	2	2	1	2	2	A	A	TEVNB
Barium Sulfate	2	2	2	-	X	2	2	2	A	A	TEVNB
Barium Sulfide	X	X	X	-	2	X	2	2	A	A	TEVNB
Beer	1	2	2	1	2	1	1	1	A	A	TEVNB
Benzaldehyde	2	2	2	2	X	2	2	2	X	X	TE
Benzene, Benzol	1	2	2	2	2	2	2	2	A	X	TV
Benzine	-	-	-	-	-	-	-	-	A	X	-
Benzoic Acid	2	2	2	-	X	2	2	2	X	X	TVN
Black Liquor	X	X	X	X	-	2	2	2	X	A	TEVNB
Bleach (12.5% Active Chlorine)	X	-	-	1	X	-	-	X	X	A	TEVN
Borax	X	2	2	1	2	1	1	1	X	A	TEVNB
Boric Acid	1	X	2	1	X	2	-	-	X	A	TEVNB
Brine Acid	-	2	2	1	-	-	-	-	X	A	TEVNB
Bromic acid	X	X	X	-	-	X	-	-	X	A	TEVN
Bromine Liquid	2	-	-	-	-	-	X	X	X	X	TV
Butadiene, Butylene	2	2	2	2	2	1	2	2	X	X	TVNB
Butane	2	2	2	2	1	1	2	2	X	X	TV
Butyl Acetate	1	2	2	2	2	2	2	2	A	X	T
Butyric Acid	2	2	X	1	X	2	2	2	A	A	TV

Ratings given are based at 70°F (21°C).





### Material Selection

AGENT	Aluminum	Brass	Bronze	Hastelloy, C-276	Malleable Iron Carbon Steel	Monel	Stainless Steel, 304	Stainless Steel, 316	Nylon	Polypropylene	Seal Material
<b>Calcium</b>											
Calcium Bisulfate	X	-	X	-	X	X	X	2	X	A	T
Calcium Bisulfide	-	-	-	-	-	2	-	2	A	A	TVB
Calcium Bisulfite	X	X	2	2	X	X	-	2	X	A	TVNB
Calcium Bromide	X	2	2	-	X	2	1	X	X	X	T
Calcium Carbonate	X	2	2	2	2	2	1	2	A	A	TEVB
Calcium Chloride (Sat.)	-	2	-	1	2	2	-	-	A	A	TEVNB
Calcium Hydroxide (Sat.)	X	2	X	-	2	2	2	2	A	A	TEVNB
Calcium Hypochlorite (Sat.)	X	X	X	-	X	X	X	2	X	A	TEV
<b>Carbon</b>											
Carbon Bisulfide	1	X	2	2	2	X	2	2	A	X	TV
Carbon Dioxide (Dry)	1	1	2	1	2	1	2	2	A	A	TENB
Carbon Dioxide (Wet)	1	X	-	2	3	-	2	2	X	A	TENB
Carbon Disulfide	1	X	2	2	2	X	2	2	A	X	TV
Carbon Monoxide	1	1	1	1	2	1	1	1	A	A	TEVNB
Carbon Tetrachloride	X	-	1	1	2	1	1	-	A	X	TV
Carbonic Acid	1	2	2	1	2	3	2	2	X	A	TEVNB
Castor Oil	2	2	2	1	2	1	2	2	A	A	TEVNB
Caustic Potash	X	-	-	1	X	-	-	2	A	A	TEVNB
<b>Caustic Soda (see Sodium Hydroxide)</b>											
Cellosolves	2	2	2	2	2	2	2	2	X	A	TE
Chlorine (Liquid)	-	-	-	1	2	2	-	3	X	X	TV
Chloroform	-	-	-	2	X	1	-	-	X	X	TV
Chlorosulfonic Acid	-	X	X	1	2	2	X	X	X	X	T
Clorox (Bleach, 5.5% CL)	X	-	-	-	X	-	-	2	X	-	TEVB
Chromic Acid (50%)	2	X	X	2	X	X	3	-	X	X	TVNB
Citric Acid	3	X	X	1	X	2	-	-	X	A	TEVNB
Coke Oven Gas	2	3	3	-	2	2	2	2	X	X	TEVN
<b>Copper</b>											
Copper Chloride	X	X	X	2	X	X	X	X	A	A	TEVNB
Copper Cyanide	X	X	X	1	-	X	2	2	X	-	TEVNB
Copper Sulfate	X	X	X	1	X	X	-	2	A	A	TEVNB
Crylic Acid (Conc.)	2	2	X	-	2	3	2	2	X	X	TEV
Cyclohexane	2	2	2	2	2	1	2	2	A	X	TVB
Detergents	2	2	2	1	2	-	1	2	A	A	TEVNB
Dextrose	2	-	-	2	-	2	-	-	A	A	TEVNB
Diesel Fuels	1	1	1	2	2	-	1	1	A	X	TVB
Diethylamine	2	-	X	-	X	1	2	2	X	A	TN
Disodium Phosphate	-	-	-	-	1	-	-	1	A	A	TEV
Ethers	2	2	2	2	2	2	1	1	A	X	TB
<b>Ethyl</b>											
Ethyl Acetate	-	-	2	2	2	2	2	2	A	X	T
Ethyl Chloride	-	-	2	2	2	2	-	1	A	X	TEVB
<b>Ethylene</b>											
Ethylene Chloride	-	-	-	-	2	2	-	-	A	X	TV
Ethylene Dichloride	-	2	X	2	2	1	2	2	A	X	TV
Ethylene Glycol	1	2	2	1	2	2	2	2	A	X	TEVNB
Ethylene Oxide	X	X	X	1	3	2	2	2	X	X	T
Fatty Acids	1	3	3	1	X	2	-	1	A	A	TVNB
<b>Ferric</b>											
Ferric Chloride	X	X	2	2	X	X	X	X	X	A	TEVNB
Ferric Hydroxide	-	-	-	1	-	2	1	1	A	-	TEVNB
Ferric Nitrate (10-50%)	X	X	X	-	X	X	2	2	X	A	TEVNB
Ferric Sulfate	X	X	X	-	X	2	-	-	X	A	TEVNB
<b>Ferrous</b>											
Ferrous Chloride (Sat.)	X	X	2	2	-	X	X	X	X	A	TEVNB
Ferrous Sulfate	2	2	2	2	X	2	2	-	X	A	TEVNB
Fluoric Acid	X	-	-	1	1	2	-	-	X	A	TEVNB
Formaldehyde (50%)	-	2	2	2	X	2	1	1	X	A	TEN
Formic Acid (Anhyd.)	1	X	2	1	X	2	-	-	X	A	TEVN
<b>Freon</b>											
Freon 11	2	2	2	-	X	1	2	2	X	X	TVNB
Freon 12	2	2	2	1	X	2	2	2	X	X	TVNB
Freon 22	2	2	2	2	X	2	2	2	X	X	TN
Fruit Juices	2	2	3	1	X	1	2	2	A	A	TVNB
Fuel Oil	2	2	2	2	2	2	2	2	A	X	TVNB
Furfural	2	2	2	2	2	2	2	2	A	X	TEN



**Material Selection**

AGENT	Aluminum	Brass	Bronze	Hastelloy, C-276	Malleable Iron Carbon Steel	Monel	Stainless Steel, 304	Stainless Steel, 316	Nylon	Polypropylene	Seal Material
Gasoline											
Refined Gasoline	2	2	2	2	2	2	2	2	A	X	TVNB
Sour Gasoline	X	2	2	2	2	X	2	2	A	X	TVNB
Gelatin	2	2	2	-	X	2	2	2	A	A	TEVNB
Glucose	2	2	2	-	2	2	2	2	A	A	TEVNB
Glue	2	2	2	1	2	2	-	2	-	A	TEVNB
Glycerine	1	1	2	1	2	1	1	1	A	A	TEVNB
Glycols	2	2	2	-	2	2	2	2	A	A	TEVNB
Green Liquor	-	-	-	-	2	-	-	-	-	A	TEVNB
Heptane	2	2	2	1	2	2	2	2	A	X	TVNB
Hexane	2	2	2	1	2	2	1	1	A	X	TVNB
Hydrobromic Acid (50%)	X	X	X	2	X	X	X	X	X	A	TEV
Hydrobromic Acid (20%)	X	X	X	1	X	X	X	X	X	A	TEV
Hydrochloric Acid (20%)	X	X	X	1	X	3	X	X	X	A	TEVNB
Hydrochloric Acid (38%)	X	X	X	1	X	X	X	X	X	A	TEVN
Hydrocyanic Acid	2	X	X	2	2	2	2	2	X	A	TEVN
Hydrofluosilicic Acid (10-50%)	X	2	X	2	X	2	X	2	X	-	TEVNB
Hydrogen											
Hydrogen Peroxide (50%)	-	X	X	2	X	2	-	-	X	A	TEV
Hydrogen Sulfide (Aqu.)	-	-	-	2	-	2	X	2	X	A	TE
Hydrogen Chloride (Dry Gas)	X	2	-	1	2	1	-	-	X	A	TEVN
Hydrogen Gas	1	1	1	1	-	1	1	1	X	A	TEVNB
Hypochlorous Acid	X	X	X	2	X	X	X	X	X	X	TEV
Iodine	1	X	X	-	X	1	X	X	X	A	TEV
Isopropyl Ether	-	2	2	-	-	2	1	2	A	X	T
Jet Fuel (JP4, JP5)	2	1	2	1	2	2	2	2	X	X	TV
Kerosene	2	2	2	2	2	2	2	2	X	X	TVNB
Ketones	2	2	2	1	2	2	2	2	A	X	T
Lactic Acid (25%)	3	2	2	1	X	X	-	-	A	A	TEVN
Lactic Acid (80%)	2	2	X	2	X	-	-	-	A	A	TEVN
Lard Oil	2	-	2	1	3	2	2	2	A	A	TVB
Lead											
Lead Acetate	X	X	X	2	X	2	2	2	X	A	TENB
Lead Chloride	X	-	-	2	-	-	2	2	X	-	TVNB
Lead Sulfate	X	-	-	2	X	2	2	2	X	-	TEVNB
Lime Sulphur	X	X	X	-	X	2	2	2	X	A	TEVN
Linoleic Acid	2	X	3	2	X	2	2	2	X	A	TVB
Linseed Oil	2	2	2	2	2	2	2	2	A	A	TVNB
Lubricants (Oil)	2	1	-	-	2	2	2	2	A	X	TVNB
Magnesium											
Magnesium Carbonate	2	-	-	-	-	2	2	2	X	A	TEVNB
Magnesium Chloride	X	X	2	1	-	-	-	-	X	A	TEVNB
Magnesium Hydroxide	2	2	2	1	2	2	1	1	X	A	TEVNB
Magnesium Nitrate	2	2	2	1	2	2	2	2	X	A	TEVNB
Magnesium Oxide	-	-	-	-	-	-	-	-	X	-	-
Magnesium Sulfate	2	-	2	-	-	1	2	2	X	A	TEVNB
Maleic Acid	-	2	3	2	X	-	-	2	X	A	TEV
Mercuric											
Mercuric Chloride	X	X	X	-	X	X	X	-	X	A	TEVB
Mercuric Cyanide	X	X	X	2	X	2	2	2	X	A	TEVB
Mercury	X	X	X	1	2	-	1	1	A	A	TEVNB
Methane	1	1	2	1	2	1	1	1	A	X	TEVNB
Methanol	2	2	2	1	2	2	2	2	A	A	TENB
Methyl											
Methyl Bromide	X	-	-	-	2	-	2	2	X	X	TV
Methyl Ethyl Ketone	2	2	2	2	2	2	2	2	A	X	TE
Methyl Isobutyl Ketone	2	2	2	2	2	2	2	2	A	X	T
Methyl Methacrylate	2	-	-	-	X	-	2	2	X	A	T
Methylene Chloride	-	2	2	X	2	-	-	-	A	X	T
Milk	1	X	X	1	2	X	1	1	A	A	TEVNB
Mineral Oil	2	1	-	-	2	1	1	2	A	A	TVNB
Muriatic Acid	X	-	-	1	-	X	X	X	X	A	TV
Napthalene	2	2	2	2	2	2	1	1	A	A	TV
Naptha	2	2	2	2	2	2	2	2	A	X	TVB

Ratings given are based at 70°F (21°C).



### Material Selection

AGENT	Aluminum	Brass	Bronze	Hastelloy, C-276	Malleable Iron Carbon Steel	Monel	Stainless Steel, 304	Stainless Steel, 316	Nylon	Polypropylene	Seal Material
<b>Nickel</b>											
Nickel Chloride	X	X	X	-	X	2	-	-	X	A	TEVNB
Nickel Sulfate	X	X	-	2	-	-	2	2	X	A	TEVNB
<b>Nitric</b>											
Nitric Acid (100%)	1	X	X	2	X	X	2	-	X	X	TV
Nitric Acid (50%)	X	X	X	1	X	X	2	-	X	X	TV
Nitric Acid (30%)	X	X	X	1	X	X	1	-	X	X	TV
Nitrobenzene	1	2	2	-	2	2	2	2	A	A	T
<b>Oils</b>											
Castor Oil	2	2	2	1	2	1	2	2	A	A	TEVNB
Coconut Oil	2	-	2	-	3	2	2	2	A	A	TVB
Corn Oil	2	2	2	-	2	2	-	2	A	A	TVNB
Cotton Seed Oil	2	2	2	-	2	1	2	2	A	A	TVNB
Fuel Oil	2	2	2	2	2	2	2	2	A	X	TVNB
Linseed Oil	2	2	2	2	2	2	2	2	A	A	TVNB
Mineral Oil	2	1	-	-	2	1	1	2	A	A	TVNB
Silicon Oil	2	1	2	-	2	-	2	2	A	A	TEVB
Vegetable Oil	2	2	2	1	2	1	1	1	A	X	TVNB
Oleic Acid	2	3	2	2	2	1	-	1	A	X	TB
Oleum	2	X	X	-	2	X	2	2	X	X	TV
Oxalic Acid (Sat.)	2	-	2	2	X	2	X	X	X	A	TEV
Oxygen	2	2	2	-	2	2	2	2	X	X	TEVNB
Palmitic Acid (Sat.)	2	3	2	-	3	2	2	2	X	A	TVB
Paraffin	2	2	2	2	2	2	2	2	A	A	TVNB
Perchloroethylene	2	2	2	2	2	1	-	-	X	X	TV
Petrolatum	2	-	2	-	3	2	2	2	A	-	TVNB
Phenol (Carbolic Acid)	1	1	X	1	2	1	-	1	X	X	TV
<b>Phosphoric Acid</b>											
Phosphoric Acid (25-50%)	X	X	2	1	X	X	-	-	X	A	TEVN
Phosphoric Acid (50-85%)	X	X	X	1	X	3	-	-	X	A	TEV
<b>Photographic Solutions</b>											
Phthalic Anhydride	-	2	2	1	2	1	1	1	X	X	TEV
Picric Acid	1	X	X	2	X	X	2	2	X	-	TEVNB
<b>Plating Solutions</b>											
Brass Plating Solution	-	-	-	1	-	-	-	2	X	A	TEVNB
Cadmium Plating Solution	-	-	-	1	-	-	-	2	X	A	TEVNB
Chrome 40% Plating Solution	X	2	2	1	X	X	2	2	X	A	TEVN
Copper (Cyanide) Plating Solution	-	-	-	1	-	-	-	-	X	A	TEVNB
Gold Plating Solution	-	-	-	1	-	-	-	1	X	A	TEVNB
Iron Plating Solution	-	-	-	-	-	-	-	-	X	A	TEVB
Lead Plating Solution	-	-	-	-	-	-	1	1	X	A	TEVNB
Nickel Plating Solution	-	-	-	1	-	-	1	1	X	A	TEVNB
Silver Plating Solution	-	-	-	1	-	-	1	1	X	A	TEVNB
Tin Plating Solution	-	-	-	1	-	-	-	3	X	A	TEVNB
Zinc Plating Solution	-	-	-	1	-	-	-	-	X	A	TEVNB
<b>Potassium</b>											
Potassium Acetate	X	X	X	-	2	-	-	-	A	A	TEVB
Potassium Bicarbonate (30%)	X	2	-	2	2	2	1	1	A	A	TEVNB
Potassium Carbonate (50%)	X	2	X	2	2	2	1	1	A	A	TEVNB
Potassium Chlorate (30%)	2	X	X	-	2	2	2	1	X	A	TEVNB
Potassium Chloride (30%)	X	X	2	-	2	1	-	-	A	A	TEVNB
Potassium Chromate (30%)	2	2	2	2	-	2	2	2	X	A	TEVB
Potassium Cyanide Solution (30%)	X	X	X	2	2	2	2	2	X	A	TEVNB
Potassium Dichromate (30%)	1	2	2	2	2	2	1	1	X	A	TEVB
Potassium Hydroxide (90%)	X	X	X	2	-	2	X	-	X	A	TENB
Potassium Nitrate (80%)	1	2	2	2	2	2	2	2	X	A	TEVNB
Potassium Permanganate (20%)	2	2	2	1	2	2	2	2	X	A	TEVN
Potassium Sulfate (10%)	1	2	2	1	2	1	1	1	A	A	TEVNB
Propane	1	1	1	2	2	1	2	2	X	X	TVB
Propylene Glycol	2	2	2	2	2	2	2	2	A	A	TVNB
Propylene Oxide (90%)	-	-	-	-	-	-	1	1	X	X	TE
Pyridine	2	2	2	-	2	2	2	2	A	X	T
Pyrogallic Acid	2	2	2	2	2	2	2	2	X	X	TVNB
Silver Nitrate	X	X	X	-	X	X	2	1	X	A	TEVNB
Soap Solutions	2	2	2	1	2	2	2	2	A	A	TEVNB

Ratings given are based at 70°F (21°C).



Material Selection

AGENT	Aluminum	Brass	Bronze	Hastelloy, C-276	Malleable Iron Carbon Steel	Monel	Stainless Steel, 304	Stainless Steel, 316	Nylon	Polypropylene	Seal Material
Sodium											
Sodium Acetate	1	2	2	-	X	2	2	2	A	A	TEN
Sodium Bicarbonate (20%)	2	2	2	1	3	1	1	1	A	A	TEVNB
Sodium Bisulfate	X	-	2	2	2	-	-	-	A	A	TEVNB
Sodium Bisulfite	X	2	X	2	X	-	-	-	A	A	TEVNB
Sodium Borate	2	2	2	2	3	2	2	2	A	A	TEVNB
Sodium Perborate (10%)	2	X	2	2	2	2	2	2	X	A	TEVNB
Sodium Carbonate	X	2	-	2	2	1	-	2	A	A	TEVNB
Sodium Chlorate (50%)	2	2	2	1	X	1	2	2	X	A	TEVNB
Sodium Cyanide	X	X	X	2	2	X	-	-	A	A	TEVNB
Sodium Dichromate	2	X	X	1	2	-	2	2	X	A	TE
Sodium Hydroxide (70%)	X	X	X	1	3	1	2	2	X	A	TENB
Sodium Hydroxide (50%)	X	X	3	1	3	1	1	-	X	A	TENB
Sodium Hydroxide (30%)	X	2	3	2	2	1	1	1	X	A	TENB
Sodium Chloride (30%)	X	2	2	2	2	1	-	-	X	A	TEVNB
Sodium Hypochlorite	X	X	X	-	X	X	-	-	X	A	TEV
Sodium Metaphosphate	X	X	2	-	X	2	2	2	X	X	TEVNB
Sodium Nitrate (40%)	1	2	-	-	2	2	1	1	A	A	TENB
Sodium Perborate (10%)	2	X	2	2	2	2	2	2	X	A	TEVNB
Sodium Peroxide (10%)	2	X	X	2	2	2	2	2	X	A	TEVNB
Sodium Silicate	1	2	2	2	2	2	2	2	A	A	TEVNB
Sodium Sulfate	-	2	2	2	2	-	-	1	A	A	TEVNB
Sodium Sulfide (50%)	X	X	X	2	2	2	-	2	X	A	TEVNB
Sodium Thiosulphate	2	X	X	2	X	2	2	2	A	A	TEVNB
Stannic Chloride	X	X	X	-	X	X	X	X	X	A	TEVNB
Stannous Chloride	X	X	X	2	X	-	X	-	X	X	TEVNB
Steam	-	-	-	-	-	-	-	-	X	-	-
Stearic Acid	2	3	2	1	3	3	2	1	A	A	TVNB
Stoddard's Solvent	2	2	2	1	2	2	2	2	X	A	TVB
Sugar Liquors (Cane)	1	2	1	-	2	2	2	2	A	A	TEVNB
Sugar Liquors (Beet)	1	2	1	-	2	1	1	1	A	A	TEVNB
Sulfate Liquors	2	X	X	2	3	2	-	2	X	A	TVNB
Sulfite Liquors	X	X	-	1	X	X	2	2	X	X	TVNB
Sulfur Chloride	X	-	X	2	X	X	-	-	X	X	TV
Sulfur Dioxide (Dry)	2	2	2	2	1	2	-	2	X	A	TE
Sulfur Trioxide	2	2	X	2	2	2	-	2	X	X	TEV
Sulfuric Acid (TO 10%)	X	2	X	1	X	X	X	X	X	A	TEVNB
Sulfuric Acid (100%)	X	X	X	1	2	X	-	-	X	X	TV
Sulfurous Acid	2	2	X	-	X	X	X	-	X	A	TV
Tannic Acid	X	-	X	-	X	2	2	2	X	A	TEVNB
Tanning Liquors	1	-	2	1	-	-	1	1	X	A	TVNB
Tartaric Acid	-	-	2	2	-	-	1	1	A	A	TVNB
Titanium Tetrachloride	X	X	X	2	2	2	-	2	X	X	TV
Toluene	1	1	1	1	1	1	1	1	A	X	TVB
Tetrahydrofuran	X	-	2	1	1	-	1	2	A	X	T
Tomato Juice	2	-	3	2	3	2	2	2	X	A	TEVNB
Trichloroethylene	1	-	2	1	2	-	-	-	A	X	TV
Triethanolamine	2	X	2	2	2	2	2	2	A	X	TEVN
Triethylamine	-	-	-	-	-	2	2	2	A	X	TVB
Trisodium Phosphate (10%)	X	2	-	1	2	2	1	1	A	A	TVNB
Turpentine	2	X	2	2	2	1	1	1	X	X	TVB
Urea (50%)	2	-	2	-	2	2	2	2	A	A	TEVNB
Urine	-	-	-	-	2	-	1	1	X	A	TEVNB
Vinegar	X	X	2	2	2	2	2	2	X	A	TEVN
Water Acid (Mine)	X	X	X	1	X	-	-	-	X	A	TEVNB
Water (Distilled)	X	2	2	1	X	X	2	2	A	A	TEVNB
Water (Sea)	2	2	2	1	X	2	2	2	A	A	TEVNB
Whiskey	X	2	2	1	2	2	1	1	X	A	TEVNB
White Liquor (Pulp)	2	-	X	2	X	X	2	2	X	A	TEVNB
Wine	X	2	2	1	X	2	1	1	X	A	TEVNB
Xylene	2	2	2	1	2	2	2	2	A	X	TV
Zinc											
Zinc Chloride	X	X	X	2	X	-	X	2	A	A	TEVNB
Zinc Nitrate	-	-	-	-	-	-	2	2	X	A	TEVNB
Zinc Sulfate (50%)	X	2	2	2	X	2	1	1	X	A	TEVNB

Ratings given are based at 70°F (21°C).



**Fraction - Decimal Conversion Chart**

	<u>Inches</u>	<u>Millimeters</u>		<u>Inches</u>	<u>Millimeters</u>
$\frac{1}{32}$	$\frac{1}{64}$ .015625	.3969	$\frac{17}{32}$	$\frac{33}{64}$ .515625	13.0969
$\frac{1}{16}$	$\frac{3}{64}$ .03125	.7938	$\frac{9}{16}$	$\frac{35}{64}$ .53125	13.4938
$\frac{3}{32}$	$\frac{5}{64}$ .046875	1.1906	$\frac{19}{32}$	$\frac{37}{64}$ .546875	13.8907
$\frac{1}{8}$	$\frac{7}{64}$ .0625	1.5875	$\frac{5}{8}$	$\frac{39}{64}$ .55625	14.2876
$\frac{5}{32}$	$\frac{9}{64}$ .078125	1.9844	$\frac{21}{32}$	$\frac{41}{64}$ .5625	14.6844
$\frac{3}{16}$	$\frac{11}{64}$ .09375	2.3813	$\frac{11}{16}$	$\frac{43}{64}$ .578125	15.0813
$\frac{7}{32}$	$\frac{13}{64}$ .109375	2.7781	$\frac{23}{32}$	$\frac{45}{64}$ .59375	15.4782
$\frac{1}{4}$	$\frac{15}{64}$ .125	3.1750	$\frac{3}{4}$	$\frac{47}{64}$ .609375	15.8751
$\frac{9}{32}$	$\frac{17}{64}$ .140625	3.5719	$\frac{25}{32}$	$\frac{49}{64}$ .625	16.2719
$\frac{5}{16}$	$\frac{19}{64}$ .15625	3.9688	$\frac{13}{16}$	$\frac{51}{64}$ .640625	16.6688
$\frac{11}{32}$	$\frac{21}{64}$ .171875	4.3656	$\frac{27}{32}$	$\frac{53}{64}$ .65625	16.6688
$\frac{3}{8}$	$\frac{23}{64}$ .1875	4.7625	$\frac{7}{8}$	$\frac{43}{64}$ .671875	17.0657
$\frac{13}{32}$	$\frac{25}{64}$ .203125	5.1594	$\frac{29}{32}$	$\frac{45}{64}$ .6875	17.4626
$\frac{7}{16}$	$\frac{27}{64}$ .21875	5.5563	$\frac{15}{16}$	$\frac{47}{64}$ .703125	17.8594
$\frac{15}{32}$	$\frac{29}{64}$ .234375	5.9531	$\frac{31}{32}$	$\frac{49}{64}$ .71875	18.2563
$\frac{1}{2}$	$\frac{31}{64}$ .250	6.3500	$\frac{1}{2}$	$\frac{51}{64}$ .734375	18.6532
	$\frac{33}{64}$ .265625	6.7469		$\frac{53}{64}$ .750	19.0501
	$\frac{35}{64}$ .28125	7.1438		$\frac{55}{64}$ .765625	19.4470
	$\frac{37}{64}$ .296875	7.5406		$\frac{57}{64}$ .78125	19.8438
	$\frac{39}{64}$ .3125	7.9375		$\frac{59}{64}$ .796875	20.2407
	$\frac{41}{64}$ .328125	8.3344		$\frac{61}{64}$ .8125	20.6376
	$\frac{43}{64}$ .34375	8.7313		$\frac{63}{64}$ .828125	21.0345
	$\frac{45}{64}$ .359375	9.1282		$\frac{65}{64}$ .84375	21.4313
	$\frac{47}{64}$ .375	9.5250		$\frac{67}{64}$ .859375	21.8282
	$\frac{49}{64}$ .390625	9.9219		$\frac{69}{64}$ .875	22.2251
	$\frac{51}{64}$ .40625	10.3188		$\frac{71}{64}$ .890625	22.6220
	$\frac{53}{64}$ .421875	10.7157		$\frac{73}{64}$ .90625	23.0188
	$\frac{55}{64}$ .4375	11.1125		$\frac{75}{64}$ .921875	23.4157
	$\frac{57}{64}$ .453125	11.5094		$\frac{77}{64}$ .9375	23.8126
	$\frac{59}{64}$ .46875	11.9063		$\frac{79}{64}$ .953125	24.2095
	$\frac{61}{64}$ .484375	12.3032		$\frac{81}{64}$ .96875	24.6063
	$\frac{63}{64}$ .500	12.7001		$\frac{83}{64}$ .984375	25.0032
				$\frac{85}{64}$ 1.000	25.4001

### Measures of Pressure

1 Pound Per Square Inch = 144 Pounds Per Square Foot = 0.068 Atmosphere = 2.042 Inches of Mercury at 62°F = 27.7 Inches of Water at 62°F = 2.31 Feet of Water at 62°F.

1 Atmosphere = 30 Inches of Mercury at 62°F = 14.7 Pounds Per Square Inch = 2116.3 Pounds Per Square Foot = 33.95 Feet of Water at 62°F.

1 Foot of Water at 62°F = 62.355 Pounds Per Square Foot = 0.433 Pounds Per Square Inch.

1 Inch of Mercury at 62°F = 1.132 Feet of Water = 13.58 Inches of Water = 0.491 Pounds Per Square Inch.

Column of Water 12 Inches High, 1 Inch in Diameter = .341 Pounds

If temperature is kept constant, the volume of a given mass of gas is inversely proportional to the pressure which is exerted upon it.

### Length Conversion Constants

Millimeters x .039370 = Inches  
 Meters x 39.370 = Inches  
 Meters x 3.2808 = Feet  
 Meters x 1.09361 = Yards  
 Kilometers x 3,280.8 = Feet  
 Kilometers x .62137 = Statute Mile  
 Kilometers x .53959 = Nautical Miles

Inches x 25.4001 = Millimeters  
 Inches x .0254 = Meters  
 Feet x .30480 = Meters  
 Yards x .91440 = Meters  
 Feet x .0003048 = Kilometers  
 Statute Miles x 1.60935 = Kilometers  
 Nautical Miles x 1.85325 = Kilometers

### Weight Conversion Constants

Grams x .03527 = Ounces (Avd.)  
 Grams x .033818 = Fluid Ounces (Water)  
 Kilograms x 35.27 = Ounces (Avd.)  
 Kilograms x 2.20462 = Pounds (Avd.)

Ounces (Avd.) x 28.35 = Grams  
 Fluid Ounces (Water) x 29.57 = Grams  
 Ounces (Avd.) x .02835 = Kilograms  
 Pounds (Avd.) x .45359 = Kilograms

### Circumference of a Circle

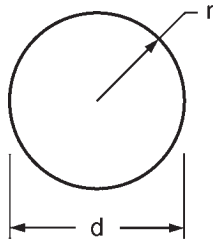

$$\text{Circumference} = 2\pi r = \pi d = 3.14159 d$$

$$\text{Area} = \pi r^2 = \pi \frac{d^2}{4} = .78539d^2$$

### Right Cylinder

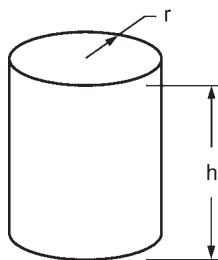

r = radius  
 h = length

$$\text{Volume} = \pi r^2 h$$

$$\text{Surface Area} = 2\pi r (r + h)$$

If end planes are parallel but not at 90° to h, the same formulas apply, but a slice at 90° through the cylinder must be used to determine r.

### Temperature Conversions

Look up reading in middle column (shaded). If in degrees Centigrade, read Fahrenheit equivalent in right-hand column; if in degrees Fahrenheit, read Centigrade equivalent in left-hand column.

°C	°F / °C	°F
-73	-100	-148
-68	-90	-130
-62	-80	-112
-57	-70	-94
-51	-60	-76
-46	-50	-58
-40	-40	-40
-34	-30	-22
-29	-20	-4
-23	-10	14
-17.8	0	32
-17.2	1	33.8
-16.7	2	35.6
-16.1	3	37.4
-15.6	4	39.2
-15.0	5	41.0
-14.4	6	42.8
-13.9	7	44.6
-13.3	8	46.4
-12.8	9	48.2
-12.2	10	50.0
-11.7	11	51.8
-11.1	12	53.6
-10.6	13	55.4
-10.0	14	57.2
-9.4	15	59.0
-8.9	16	60.8
-8.3	17	62.6
-7.8	18	64.4
-7.2	19	66.2
-6.7	20	68.0
-6.1	21	69.8
-5.6	22	71.6
-5.0	23	73.4
-4.4	24	75.2
-3.9	25	77.0
-3.3	26	78.8
-2.8	27	80.6
-2.2	28	82.4
-1.7	29	84.2
-1.1	30	86.0
-.6	31	87.8
0	32	89.6
.6	33	91.4
1.1	34	93.2
1.7	35	95.0
2.2	36	96.8
2.8	37	98.6
3.3	38	100.4
3.9	39	102.2
4.4	40	104.0

°C	°F / °C	°F
5.0	41	105.8
5.6	42	107.6
6.1	43	109.4
6.7	44	111.2
7.2	45	113.0
7.8	46	114.8
8.3	47	116.6
8.9	48	118.4
9.4	49	120.2
10.0	50	122.0
10.6	51	123.8
11.1	52	125.6
11.7	53	127.4
12.2	54	129.2
12.8	55	131.0
13.3	56	132.8
13.9	57	134.6
14.4	58	136.4
15.0	59	138.2
15.6	60	140.0
16.1	61	141.8
16.7	62	143.6
17.2	63	145.4
17.8	64	147.2
18.3	65	149.0
18.9	66	150.8
19.4	67	152.6
20.0	68	154.4
20.6	69	156.2
21.1	70	158.0
21.7	71	159.8
22.2	72	161.6
22.8	73	163.4
23.3	74	165.2
23.9	75	167.0
24.4	76	168.8
25.0	77	170.6
25.6	78	172.4
26.1	79	174.2
26.7	80	176.0
27.2	81	177.8
27.8	82	179.6
28.3	83	181.4
28.9	84	183.2
29.4	85	185.0
30.0	86	186.8
30.6	87	188.6
31.1	88	190.4
31.7	89	192.2
32.2	90	194.0
32.8	91	195.8

°C	°F / °C	°F
33.3	92	197.6
33.9	93	199.4
34.4	94	201.2
35.0	95	203.0
35.6	96	204.8
36.1	97	206.6
36.7	98	208.4
37.2	99	210.2
37.8	100	212.0
43	110	230
49	120	248
54	130	266
60	140	284
66	150	302
71	160	320
77	170	338
82	180	356
88	190	374
93	200	392
99	210	410
100	212	413.6
104	220	428
110	230	446
116	240	464
121	250	482
127	260	500
132	270	518
138	280	536
143	290	554
149	300	572
154	310	590
160	320	608
166	320	626
170	338	640
171	340	644
177	350	662
182	360	680
186	366	691
188	370	698
193	380	716
198	388	730
199	390	734
204	400	752
208	406	763
210	410	770
216	420	788
221	430	806
227	440	824
232	450	842
32.8	91	195.8



## Steam Temperature and Pressure Conversion Guide

### Temperature - Pressure Equivalents of Saturated Steam Gauge Pressure at Sea Level

• Degrees Celsius = 5/9 (Degrees F - 32)

Temperature		Lbs. per Sq. Inch	Temperature		Lbs. per Sq. Inch	Temperature		Lbs. per Sq. Inch
°F	°C		°F	°C		°F	°C	
212	100.0	0.0	286	141.1	39.4	336	168.9	97.1
214	101.1	0.6	287	141.7	40.3	337	169.4	98.7
216	102.2	1.2	288	142.2	41.1	338	170.0	100.2
218	103.3	1.8	289	142.8	42.0	339	170.6	101.8
220	104.4	2.5	290	143.3	42.9	340	171.1	103.3
222	105.6	3.2	291	143.9	43.8	341	171.7	105.0
224	106.7	3.9	292	144.4	44.7	342	172.2	106.5
226	107.8	4.6	293	145.0	45.6	343	172.8	108.2
228	108.9	5.3	294	145.6	46.5	344	173.3	109.8
230	110.0	6.1	295	146.1	47.5	345	173.9	111.5
232	111.1	6.9	296	146.7	48.4	346	174.4	113.1
234	112.2	7.7	297	147.2	49.4	347	175.0	114.8
236	113.3	8.5	298	147.8	50.3	348	175.6	116.5
238	114.4	9.4	299	148.3	51.3	349	176.1	118.2
240	115.6	10.3	300	148.9	52.3	350	176.7	119.9
242	116.7	11.2	301	149.4	53.4	352	177.8	123.5
244	117.8	12.1	302	150.0	54.4	354	178.9	127.1
246	118.9	13.1	303	150.6	55.4	356	180.0	130.8
248	120.0	14.1	304	151.1	56.4	358	181.1	134.5
250	121.1	15.1	305	151.7	57.5	360	182.2	138.3
252	122.2	16.2	306	152.2	58.6	362	183.3	142.3
254	123.3	17.3	307	152.8	59.7	364	184.4	146.2
256	124.4	18.4	308	153.3	60.7	366	185.6	150.3
258	125.6	19.6	309	153.9	61.9	368	186.7	154.4
260	126.7	20.7	310	154.4	63.0	370	187.8	158.7
261	127.2	21.4	311	155.0	64.2	372	188.9	163.0
262	127.8	22.0	312	155.6	65.3	374	190.0	167.4
263	128.3	22.6	313	156.1	66.5	376	191.1	171.9
264	128.9	23.2	314	156.7	67.6	378	192.2	176.4
265	129.4	23.9	315	157.2	68.8	380	193.3	181.1
266	130.0	24.5	316	157.8	70.0	382	194.4	185.8
267	130.6	25.2	317	158.3	71.3	384	195.6	190.6
268	131.1	25.8	318	158.9	72.5	386	196.7	195.6
269	131.7	26.5	319	159.4	73.7	388	197.8	200.6
270	132.2	27.2	320	160.0	75.0	390	198.9	205.7
271	132.8	27.9	321	160.6	76.3	392	200.0	210.9
272	133.3	28.6	322	161.1	77.5	394	201.1	216.2
273	133.9	29.3	323	161.7	78.8	396	202.2	221.5
274	134.4	30.0	324	162.2	80.1	398	203.3	227.0
275	135.0	30.8	325	162.8	81.5	400	204.4	232.6
276	135.6	31.5	326	163.3	82.8	402	205.5	238.0
277	136.1	32.3	327	163.9	84.2	404	206.7	244.0
278	136.7	33.0	328	164.4	85.6	406	207.8	250.0
279	137.2	33.8	329	165.0	87.0	408	208.9	256.0
280	137.8	34.5	330	165.6	88.4	410	210.0	262.0
281	138.3	35.3	331	166.1	89.8	412	211.1	268.0
282	138.9	36.1	332	166.7	91.2	414	212.2	275.0
283	139.4	36.9	333	167.2	92.7	416	213.3	281.0
284	140.0	37.7	334	167.8	94.1	418	214.4	288.0
285	140.6	38.6	335	168.3	95.6	420	215.6	294.0

### Pressure Conversions

100 PSI = 6.9 Bars  
 250 PSI = 17.25 Bars  
 600 PSI = 41.4 Bars

5 Bars = 72.5 PSI  
 10 Bars = 145 PSI  
 25 Bars = 362.5 PSI





## Pressure - Temperature Ratings

- Ratings apply to all products covered by ANSI B16.5 valves conforming to the requirements of this standard must, in other respects, merit these ratings.
- All ratings are maximum allowable non-shock pressures (PSIG) at the tabulated temperatures (degree Fahrenheit). Temperatures are those on the inside of the pressure retaining structure.
- The use of these ratings requires gaskets conforming to the requirements of ANSI B16.5. The user is responsible for selecting gaskets of dimensions and materials to withstand the required bolt loading without injurious crushing, and suitable for the service conditions in all other respects.

Pressure Class	150	300
Test Pressure	425	1100
Service Temperature °F	Working Pressure	
-20 to 100	275	720
150	255	710
200	240	700
250	225	690
300	210	680
350	195	675
400	180	665
450	165	650
500	150	625
550	140	590
600	130	555
650	120	515
700	110	470
750	100	425

### Air Velocity in a Pipe

Using the equation and typical values of V, D, and L explained to the right approximate values of P are computed as follows:

Velocity Ft / Sec	Pipe Diameter in Inches, 10' long				
	1	2	4	6	10
1	.0004	.0002	.0001	.00007	.00004
2	.0016	.0008	.0004	.00030	.00016
5	.0100	.0050	.0025	.00170	.0010
10	.0400	.0200	.0100	.00670	.0040
15	.0900	.0450	.0225	.01500	.0090
20	.1600	.0800	.0400	.02700	.0160
25	.2500	.1250	.0625	.04170	.0250
30	.3600	.1800	.0900	.06000	.0360

$$V = \sqrt{\frac{25,000 DP}{L}}$$

- V = air velocity in feet per second
- D = pipe inside diameter in inches
- L = length of pipe in feet
- P = pressure loss due to air friction in ounces/square inch

### Air Volume Discharged from Pipe

- CFM = air volume in cubic feet per minute
- V = air velocity in feet per second as determined in the equation at the top of this page
- A = cross section area of pipe in square feet

$$CFM = 60VA$$

### Boyle's Law

If temperature is kept constant, the volume of a given mass of gas is inversely proportional to the pressure which is exerted upon it.

$$\frac{\text{Initial Pressure}}{\text{Final Pressure}} = \frac{\text{Final Volume}}{\text{Initial Volume}}$$

### Air Supply Requirements (operating pressure: 90 PSI)

Tool	Class	Typical Air Consumption (CFM)	Hose Size (inches)		
			0 - 10 ft.	10 - 50 ft.	50 - 200 ft.
Paving breakers	25 lb.	45	1/2"	1/2"	3/4"
	35 lb.	50	1/2"	3/4"	3/4"
	60 lb.	65	1/2"	3/4"	1"
	80 lb.	80	3/4"	3/4"	1"
Clay diggers		45	1/2"	1/2"	3/4"
Hand drills	8 lb.	20	3/8"	3/8"	1/2"
	15 lb.	32	3/8"	1/2"	1/2"
Rock (sinker) drills	45 lb.	105	3/4"	3/4"	1"
	55 lb.	130	3/4"	1"	1"
Tampers	5" butt	20	3/8"	1/2"	1/2"
	6" butt	30	1/2"	1/2"	3/4"
Sump pump	3 HP	100	3/4"	3/4"	1"
Sludge pump	Ejector	90	1"	1"	1"
Vibrators	2-1/2"	60	1"	1"	1"
	3"	60	1"	1"	1"
Chipping hammers		25	3/8"	1/2"	1/2"
Impact wrenches	3/8" sq. dr.	10	5/16"	3/8"	3/8"
	1/2"	15	5/16"	3/8"	1/2"
	3/4"	25	3/8"	1/2"	1/2"
	1"	50	1/2"	3/4"	3/4"
Drills	1/4" - 1/2"	22	3/8"	3/8"	1/2"
Grinders	die / burr	20	3/8"	3/8"	1/2"
	small angle	20	3/8"	3/8"	1/2"
	3 HP vertical	75	1/2"	3/4"	1"



### CFM vs PSI for Nozzles

- PSI = pounds/square inch
- CFM = cubic feet/minute

Gauge PSI	CFM Free Air Flow @ Nozzle Diameter (inches)							
	1/64	1/32	3/64	1/16	3/32	1/8	3/16	1/4
1	.03"	.11"	.2"	.4"	1.0"	1.7"	3.9"	6.8"
5	.06"	.24"	.5"	1.0"	2.2"	3.9"	8.7"	15.4"
10	.08"	.34"	.8"	1.4"	3.1"	5.4"	12.3"	21.8"
15	.10"	.42"	.9"	1.6"	3.7"	6.6"	15.0"	26.7"
20	.12"	.48"	1.1"	1.9"	4.2"	7.7"	17.1"	30.8"
25	.13"	.54"	1.2"	2.2"	4.7"	8.6"	19.4"	34.5"
30	.16"	.63"	1.4"	2.5"	5.6"	10.0"	22.5"	40.0"
40	.19"	.77"	1.7"	3.1"	6.8"	12.3"	27.5"	49.1"
50	.22"	.91"	2.0"	3.6"	8.2"	14.5"	32.8"	58.2"
60	.26"	1.05"	2.3"	4.2"	9.4"	16.8"	37.5"	67.0"
70	.29"	1.19"	2.7"	4.8"	10.7"	19.0"	43.0"	76.0"
80	.33"	1.33"	3.0"	5.3"	11.9"	21.2"	47.5"	85.0"
90	.36"	1.47"	3.3"	5.9"	13.1"	23.5"	52.5"	94.0"
100	.40"	1.61"	3.7"	6.4"	14.5"	25.8"	58.3"	103.0"
110	.43"	1.76"	3.9"	7.0"	15.7"	28.0"	63.0"	112.0"
120	.47"	1.90"	4.3"	7.6"	17.0"	30.2"	68.0"	121.0"
130	.50"	2.04"	4.6"	8.1"	18.2"	32.4"	73.0"	130.0"
140	.54"	2.17"	4.9"	8.7"	19.5"	34.5"	78.0"	138.0"
150	.57"	2.33"	5.2"	9.2"	20.7"	36.7"	83.0"	147.0"
175	.66"	2.65"	5.9"	10.6"	23.8"	42.1"	95.0"	169.0"
200	.76"	3.07"	6.9"	12.2"	27.5"	48.7"	110.0"	195.0"

### Air Receiver Capacities

Tank Size (inches)	Tank Size (gallons)	Gauge Pressure on Tank (PSI)			
		0	100	150	200
<b>Cubic Feet Tank Capacity</b>					
12 x 24	10	1.3	11	15	19
14 x 36	20	2.7	21	30	39
16 x 36	30	4.0	31	45	59
20 x 48	60	8.0	62	90	117
20 x 63	80	10.7	83	120	156
24 x 68	120	16.0	125	180	234
30 x 84	240	32.0	250	360	467

If your tank is not listed in the table to the left, use the following formula to calculate the tank size (gallons) and then estimate the cubic feet tank capacity at a given pressure from the table above.

$$\text{Tank Gallons} = \frac{\text{Tank Height} \times (\text{Tank Radius})^2}{73.53}$$

Height and radius are in inches



**Air Hose Friction**

- PSI = pressure in pounds/square inch
- CFM = air flow in cubic feet/minute

Hose Size (inches)	CFM thru 50' Hose	Gauge Pressure - Pounds/sq inch			
		50	70	90	110
		PSI Loss Over 50' Hose Length			
1/2"	20	1.8	1.0	.8	.6
	30	5.0	3.4	2.4	2.0
	40	10.1	7.0	5.4	4.3
	50	18.1	12.4	9.5	7.6
	60	+	20.0	14.8	12.0
	70	+	28.4	22.0	17.6
	80	+	+	30.5	24.6
	90	+	+	41.0	33.3
	10	+	+	+	44.5
	110	+	+	+	+
3/4"	20	.04	.2	.2	.1
	30	.08	.5	.4	.3
	40	1.5	.9	.7	.5
	50	2.4	1.5	1.1	.9
	60	3.5	2.3	1.6	1.3
	70	4.4	3.2	2.3	1.8
	80	6.5	4.2	3.1	2.4
	90	8.5	5.5	4.0	3.1
	100	11.4	7.0	5.0	3.9
	110	14.2	8.8	6.2	4.9
1"	20	.1	0	0	0
	30	.2	.1	.1	.1
	40	.3	.2	.2	.2
	50	.5	.4	.3	.2
	60	.8	.5	.4	.3
	70	1.1	.7	.6	.4
	80	1.5	1.0	.7	.6
	90	2.0	1.3	.9	.7
	100	2.6	1.6	1.2	.9
	110	3.5	2.0	1.4	1.1
120	4.8	2.5	1.7	1.3	
130	7.0	3.1	2.0	1.5	

+ Pressure loss is too great and therefore the combination of hose size, CFM, and gauge pressure is not recommended. Gauge pressures are the indicated air pressure, in pounds/square inch, at the source (i.e. the air compressor receiver tank).

## Maximum Recommended Air Flow (SCFM) Through ANSI Standard Weight Schedule 40 Metal Pipe

- Flow values in the table below are based on a pressure drop of 10% of the applied pressure per 100 feet of pipe for 1/8", 1/4", 3/8", and 1/2" pipe sizes; and a pressure drop of 5% of the applied pressure per 100 feet of pipe for 3/4", 1", 1-1/4", 2", 2-1/2", 3" pipe sizes. The table gives recommended flows for pipe sizes at listed pressures and should be used to determine appropriate piping for air systems.

Applied Pressure PSI	Nominal Standard Pipe Size										
	1/8"	1/4"	3/8"	1/2"	3/4"	1"	1-1/4"	1-1/2"	2"	2-1/2"	3"
5	0.5	1.2	2.7	4.9	6.6	13	27	40	80	135	240
10	0.8	1.7	3.9	7.7	11.0	21	44	64	125	200	370
20	1.3	3.0	6.6	13.0	18.5	35	75	110	215	350	600
40	2.5	5.5	12.0	23.0	34.0	62	135	200	385	640	1100
60	3.5	8.0	18.0	34.0	50.0	93	195	290	560	900	1600
80	4.7	10.5	23.0	44.0	65.0	120	255	380	720	1200	2100
100	5.8	13.0	29.0	54.0	80.0	150	315	470	900	1450	2600
150	8.6	20.0	41.0	80.0	115.0	220	460	680	1350	2200	3900
200	11.5	26.0	58.0	108.0	155.0	290	620	910	1750	2800	5000
250	14.5	33.0	73.0	135.0	200.0	370	770	1150	2200	3500	6100

### Suggested Pipe Size for Compressed Air Flow at 100 PSI Length of Run, Feet

SCFM Air Flow	25	50	75	100	150	200	300	500	1000	Compressor HP
4	1/2	1/2	1/2	1/2	1/2	1/2	1/2	3/4	3/4	1
12	1/2	1/2	1/2	3/4	3/4	1/2	3/4	1	1	3
20	3/4	3/4	3/4	3/4	1	3/4	1	1-1/4	1-1/4	5
30	3/4	3/4	1	1	1	1	1-1/4	1-1/4	1-1/4	7-1/2
40	3/4	1	1	1	1-1/4	1	1-1/4	1-1/2	1-1/2	10
60	1	1	1-1/4	1-1/4	1-1/4	1-1/4	1-1/2	1-1/2	2	15
80	1	1-1/4	1-1/4	1-1/4	1-1/2	1-1/4	1-1/2	2	2	20
100	1-1/4	1-1/4	1-1/2	1-1/2	1-1/2	1-1/2	2	2	2-1/2	25
120	1-1/4	1-1/2	1-1/2	1-1/2	2	1-1/2	2	2-1/2	2-1/2	30
160	1-1/4	1-1/2	1-1/2	2	2	1-1/2	2-1/2	2-1/2	3	40
200	1-1/2	2	2	2	2	2	2-1/2	3	3	50
240	1-1/2	2	2	2	2-1/2	2	2-1/2	3	3	60
300	2	2	2	2-1/2	2-1/2	2	3	3	3-1/2	75
400	2	2-1/2	2-1/2	2-1/2	3	2-1/2	3	3-1/2	4	100
500	2	2-1/2	2-1/2	3	3	2-1/2	3-1/2	3-1/2	4	125

On a compressed air distribution system, pressure losses greater than 3% are considered excessive, and a well-designed system having a steady rate of air flow is usually designed for not more than a 1% loss or 1 PSI for a 100 PSI system. The pipe size depends not only on the volume of air flow but how far it must be carried. To hold the distribution loss to 1 PSI, pipes of larger diameter must be used on longer runs to carry the same flow that can be handled by smaller pipes on shorter runs.

Figures in the body of the chart above are pipe sizes recommended on a 100 PSI system to carry air with less than 1 PSI loss. When measuring lengths of runs, add 5' of length for each pipe fitting. If carrying 120 PSI pressure these sizes will carry slightly more air than shown, or pressure loss will be slightly less than 1 PSI. If carrying 80 PSI pressure these pipes will carry slightly less air at 1 PSI pressure loss than shown in the chart.

The left column of the chart shows the volume of air to be carried. It is difficult to estimate the air flow volume to be carried in each leg of the distribution system. This varies with the application. On some applications, like in a large plant with many legs in the distribution system serving dozens of air-operated machines, the air usage may be at a fairly steady rate. Other applications, usually on small systems, may have to carry a high surge of air if several machines happen to be operated at the same time. Then there may be a period with almost no flow.

To make a realistic estimate of air flow volume, the far right column of the chart showing compressor HP may be used. On steady pumping, a compressor will produce a minimum of 4 SCFM air flow for each 1 HP of capacity. This is a conservative figure, as most compressors will produce 5 or 6 SCFM.

For example, a 25 HP compressor will produce at least 100 SCFM of air as shown in the far left column on the same line as 25 HP.

(Excerpted from *Industrial Fluid Power*, Volume 1, third edition, 1984)



**Water Constants and Formulas**

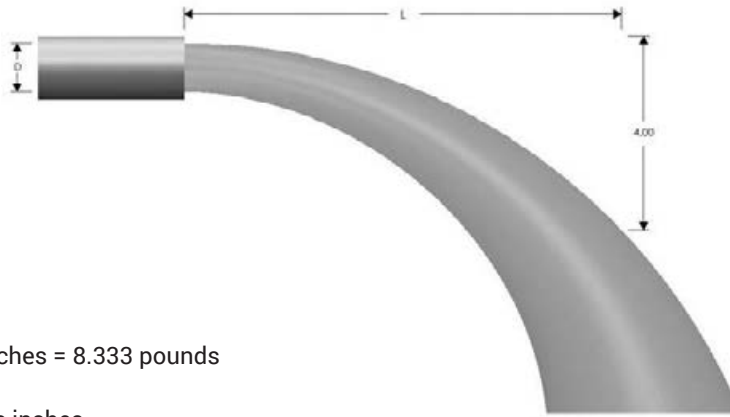

1 gallon water = 231 cubic inches = 8.333 pounds

1 pound of water = 27.7 cubic inches

1 cubic foot water = 7.5 gallons = 62.5 pounds (salt water weighs approximately 64.3 pounds per cubic foot)

Pounds per square inch at bottom of a column of water = height of column in feet x .434

1 miner's inch = 9 to 12 gallons per minute

Horsepower to raise water:  
If pumping liquid other than water, multiply the gallons per minute below by the liquid's specific gravity

$$\text{Horsepower} = \frac{\text{gallons per minute} \times \text{total head in feet}}{3,960}$$

Gallons per minute through a pipe:  
GPM = .0408 x pipe diameter inches<sup>2</sup> x feet/minute water velocity

Weight of water in a pipe:  
Pounds water = pipe length feet x pipe diameter inches<sup>2</sup> x .34

L Distance (inches)	Gallons per Minute Discharge for a Given Nominal Pipe Diameter D (inches)				
	5	6	8	10	12
5	163	---	---	---	---
6	195	285	---	---	---
7	228	334	580	---	---
8	260	380	665	1060	---
9	293	430	750	1190	1660
10	326	476	830	1330	1850
11	360	525	915	1460	2020
12	390	570	1000	1600	2220
13	425	620	1080	1730	2400
14	456	670	1160	1860	2590
15	490	710	1250	2000	2780
16	520	760	1330	2120	2960
17	550	810	1410	2260	3140
18	590	860	1500	2390	3330
19	620	910	1580	2520	3500
20	650	950	1660	2660	3700
21	685	1000	1750	2800	3890
22	720	1050	1830	2920	4060
23	750	1100	1910	3060	4250
24	---	1140	2000	3200	4440

**Water Discharge Table**

This table is intended for general reference and general applicability only and should not be relied upon as the sole or precise source of information available with respect to the subject covered. The user should also refer to and follow manufacturers' specific instructions and recommendations with regard to such information, where they exist.

**Flow of water through 100 foot lengths of hose, Straight - Smooth Bore - US gallons per minute**

PSI at Hose Inlet	Nominal Hose I.D. Diameters - Inches							
	1"	1-1/4"	1-1/2"	2"	2-1/2"	3"	4"	6"
20	26	47	76	161	290	468	997	2895
30	32	58	94	200	360	582	1240	3603
40	38	68	110	234	421	680	1449	4209
50	43	77	124	264	475	767	1635	4748
60	47	85	137	291	524	846	1804	5239
75	53	95	154	329	591	955	2035	5910
100	62	112	180	384	690	1115	2377	6904
125	70	126	203	433	779	1258	2681	7788
150	77	139	224	478	859	1388	2958	8593
200	90	162	262	558	1004	1621	3455	10038

Figures are to be used as a guide since the hose inside diameter tolerance, the type of fittings used, and orifice restriction all influence the actual discharge. Thus, variations plus or minus from the table may be obtained in actual service.

### Conversion Table - Feet of Water to Inches of Mercury

Feet of Water	1	2	4	6	8	10	12	14	16	20	22	24	26	28	30	32	34
Inches of Mercury	0.9	1.8	3.5	5.3	7.1	8.8	10.6	12.4	14.1	17.7	19.4	21.2	23.0	24.8	26.5	28.3	30.0

### Feet Head of Water to PSI

- One foot of water at 62°F = 0.433 PSI, to find the PSI for any feet head not given in the table, multiply the feet head by 0.433.

Feet Head	Pounds per Square Inch
1	0.43
2	0.87
3	1.30
4	1.73
5	2.17
6	2.60
7	3.03
8	3.46
9	3.90
10	4.33
15	6.50
20	8.66
25	10.83
30	12.99
40	17.32
50	21.65
60	25.99
70	30.32
80	34.65
90	38.98
100	43.31
110	47.64
120	51.97
130	56.30
140	60.63
150	64.96
160	69.29
170	73.63
180	77.96
200	86.62
250	108.27
300	129.93
350	151.58
400	173.24
500	216.55
600	259.85
700	303.16
800	346.47
900	389.78
1000	433.00

## Thread Information

### Pipe Threads

Pipe threads are either tapered or straight (parallel). The two styles may or may not be compatible. Refer to thread information chart on page 1127.

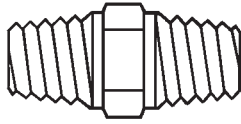

tapered threads

#### Tapered threads

Tapered threads are the most common type of thread available. As the name implies, they have a slight taper. When mated together and tightened, the threads compress and may form a seal. Usually a thread sealant is required. The mating threads both hold the fitting in place and seal the connection. The most widely used pipe threads in North America are NPT (National Pipe Taper). Some confusion may result from the use of NPT, FPT, and MPT in describing threads. Both FPT and MPT are NPT threads, with FPT meaning female threads (internal) and MPT meaning male threads (external).

NPTF (Dryseal) threads are modified NPT threads, which are less likely to leak without a sealant. For a leak-free seal, we recommend using a sealant compound or PTFE tape. You can use NPTF threads with NPT threads, but you'll lose some of the leak-free characteristics.

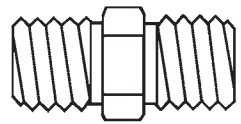

straight threads

#### Straight threads

Straight (parallel) threads are used for mechanical joining. They serve one purpose - to hold a fitting in place. As a result, an O-ring (elastomer), hard metal seal or a soft seat seal is required. Straight pipe threads include NPSM (National Pipe Straight Mechanical), and NPSH (National Pipe Straight Hose). Sizing and pitches may differ from the NPT threads

Less common straight threads are GHT (Garden Hose) and NST (fire hose coupling).

#### NPT vs. BSP (British Standard Pipe)

BSP threads are common in many countries outside the United States. BSP consists of two types of threads - BSPT (British Standard Pipe Taper) and BSPP (British Standard Pipe Parallel).

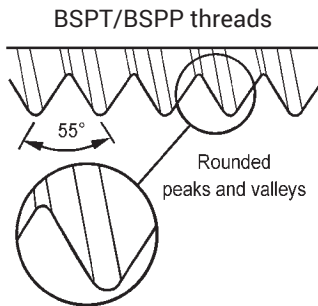

BSPT threads have a slight taper similar to NPT. BSPP threads are straight (parallel) threads and have the same thread angle, shape and threads per inch (pitch) as BSPT threads. *BSPT and BSPP threads should not be substituted for NPT threads.*

NPT and BSPT/BSPP threads have different angles, shape, and (in most cases) threads per inch (pitch). The thread angle is 60° for NPT threads; 55° for BSPT/BSPP threads. NPT threads are flattened at the peaks and valleys, while BSPT/BSPP threads are rounded.

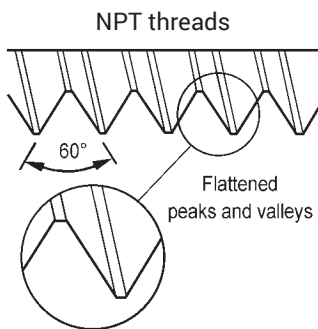

Nominal Pipe Size	Threads per inch	
	NPT	BSPT / BSPP
1/16"	27	---
1/8"	27	28
1/4"	18	19
3/8"	18	19
1/2"	14	14
3/4"	14	14
1"	11-1/2	11
1-1/4"	11-1/2	11
1-1/2"	11-1/2	11
2"	11-1/2	11
2-1/2"	8	11
3"	8	11
3-1/2"	8	11
4"	8	11
5"	8	11
6"	8	11
8"	8	11



## Thread Information

### Identifying Threads

*It is important to identify the threads required before ordering couplings.*

Identifying threads can sometimes be the most difficult and frustrating part of coupling selection. However, without the right combination of threads, you may not provide a functional or safe connection.

The diameters, threads per inch (TPI) and thread pitch, etc. are necessary to completely identify a thread. Ring, plug, and GO/NOGO gauges are required to accurately gauge or identify threads. In the field, in the absence of these gauges, thread leaf gauges can be used to identify the threads per inch (TPI) and the thread pitch. On threads you have determined to be straight threads, a caliper can be used to measure the outside diameter of the male (ODM) or the inside diameter of the female (IDF). A caliper can also be used to take measurements of tapered thread diameters. However, these are more difficult to define because of the taper. Fortunately, there are few tapered threads to deal with and these can usually be identified from the nominal ODM and the TPI.

However, identifying the thread may not fully identify what is needed in a mating fitting. The application is the primary *limiting factor on the thread type used*. Dixon® offers products with a wide variety of threads used with hose, pipe, and hydraulics.

When attempting to choose a fitting, it is always advisable to first identify the thread to which it must connect. This may entail checking with a fitting or equipment manufacturer.

*The fire hose thread specifications for some local municipal fire equipment and hydrants may vary according to local specifications. These can generally be most easily identified by contacting the local fire department responsible for the hydrant. The most common thread used on fire equipment is National Standard Thread (NST), also known as National Hose thread (NH).*

#### When it is not possible to identify the thread:

1. Determine the number of threads per inch by measuring the distance from peak of thread to peak of thread across the largest number of whole threads. Then divide the number of threads by the measurement (this will provide the TPI).
2. Check to see if the thread is straight or tapered.
  - a) Straight Threads  
Measure the outside diameter of the male (ODM) or the inside diameter of the female (IDF), from peak of thread to peak of thread.
  - b) Tapered Threads  
Measure the outside diameter of the male (ODM) at the large end and the small end, or the inside diameter of the female (IDF) at the large end and the small end, from peak of thread to peak of thread. Then measure the outside diameter (O.D.) of the unthreaded pipe.

Once the application and these two pieces of information have been determined, the thread can generally be determined. When in doubt, call Dixon at 800.355.1991.

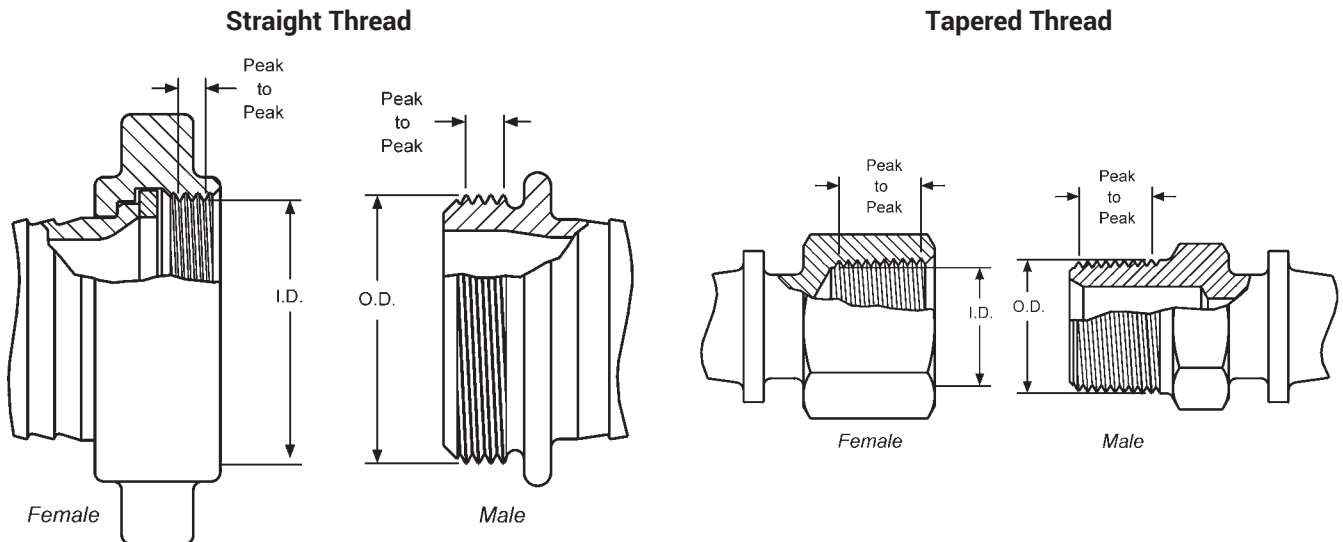

**Thread Types**

Abbreviation	System Name	Compatibility	Seal Method
BSPP	British Standard Pipe Parallel	male BSPP with female BSPP	washer
		female BSPP with male BSPP	washer
		female BSPP with male BSPT	washer
BSPT <sub>r</sub>	British Standard Pipe Taper	male BSPT <sub>r</sub> with female BSPT <sub>r</sub>	thread
		male BSPT <sub>r</sub> with female BSPP	washer
		female BSPT <sub>r</sub> with male BSPT <sub>r</sub>	thread
		female BSPT <sub>r</sub> not compatible with male BSPP	
CHT	American Standard Fire Hose Thread (1" National Hose Thread is Chemical Hose Thread, also known as Booster Hose Thread)	1" male NH (NST) with 1" female NH (NST)	washer
		1" female NH (NST) with 1" male NH (NST)	washer
		1" thread is used on both 3/4" hose & 1" hose	not compatible
GHT	Garden Hose Thread	male GHT with female GHT	washer
		female GHT with male GHT	washer
		thread is same for all size hose	not compatible
IPS	Iron Pipe Straight Thread	generic name for Straight Pipe Thread see NPSH for compatibility	washer
IPT	Iron Pipe Thread	generic name for All Pipe Thread	more information required
JIC	Joint Industrial Committee	used with other mating JIC threads	mechanical
NH or NST	American Standard Fire Hose Coupling Thread (National Hose thread also known as National Standard Thread)	male NH (NST) with female NH (NST)	washer
		female NH (NST) with male NH (NST) thread pitch and diameters of fire threads may vary according to local and municipal regulations not compatible with other systems	washer
NPT	American Standard Taper Pipe Thread (National Pipe Tapered)	male NPT with female NPT	thread
		male NPT with female NPTF	thread
		male NPT with female NPSM	washer
		male NPT with female NPSH	washer
		female NPT with male NPT	thread
		female NPT with male NPTF female NPT not compatible with male NPSM or male NPSH	thread
NPTF	American Standard Taper Pipe Fuel Dryseal Thread (National Pipe Tapered Dryseal)	male NPTF with female NPTF	thread
		male NPTF with female NPT	thread
		male NPTF with female NPSM	washer
		male NPTF with female NPSH	washer
		female NPTF with male NPTF	thread
		female NPTF with male NPT	thread
		female NPTF with male NPSM or NPSH NPTF with NPTF threads do not require sealant for the initial use, after that, sealant is required	not compatible
NPSH	American Standard Straight Pipe for Hose Couplings (National Pipe Straight Hose)	male NPSH with female NPSH	washer
		female NPSH with male NPSH	washer
		female NPSH with male NPT	washer
		female NPSH with male NPTF	washer
		female NPSH with male NPSM	washer
NPSM	American Standard Straight Mechanical Joints (National Pipe Straight Mechanical)	male NPSM with female NPSM	Seal can be either mechanical or washer. Mating fittings must be of same type.
		male NPSM with female NPSH	
		female NPSM with male NPSM	
		female NPSM with male NPT	
		female NPSM with male NPTF	
SIPT	Straight Iron Pipe Thread	generic name for Straight Pipe Thread	washer
TIPT	Tapered Iron Pipe Thread	generic name for Tapered Pipe Thread	thread
NYFD	NYFD Fire Department	straight thread used in New York City	washer
Chicago	Chicago Fire Department	straight thread used in Chicago	washer



### Thread Chart for Hydraulic Fittings

Dash Size	2	4	6	8	10	12	16	20	24	32	40	48
JIC 37 degree Flare Thread	5/16-24	7/16-20	9/16-18	3/4-16	7/8-14	1-1/16-12	1-5/16-12	1-5/8-12	1-7/8-12	2-1/2-12	--	--
SAE O-ring Thread	--	7/16-20	9/16-18	3/4-16	7/8-14	1-1/16-12	1-5/16-12	1-5/8-12	1-7/8-12	2-1/2-12	--	--
NPTF Pipe Thread	1/8-27	1/4-18	3/8-18	1/2-14	--	3/4-14	1-11 1/2	1-1/4-11 1/2	1-1/2-11 1/2	2-11 1/2	--	--
NPSM Swivel Thread	--	1/4-18	3/8-18	1/2-14	--	3/4-14	1-11 1/2	1-1/4-11 1/2	1-1/2-11 1/2	2-11 1/2	--	--
Flat Face Thread	--	9/16-18	11/16-16	13/16-16	1-14	1-3/16-12	1-7/16-12	--	--	--	--	--
Code 61 Flange Head O.D.	--	--	--	1.19	--	1.50	1.75	2.00	2.38	2.81	3.31	4.0
Code 62 Flange Head O.D.	--	--	--	1.25	--	1.62	1.88	2.12	2.50	3.12	--	--
British Thread BSPP/BSPT	--	1/4-19	3/8-19	1/2-14	--	3/4-14	1-11	--	--	--	--	--

### Fittings Size Chart

#### Male NPT Thread Sizes

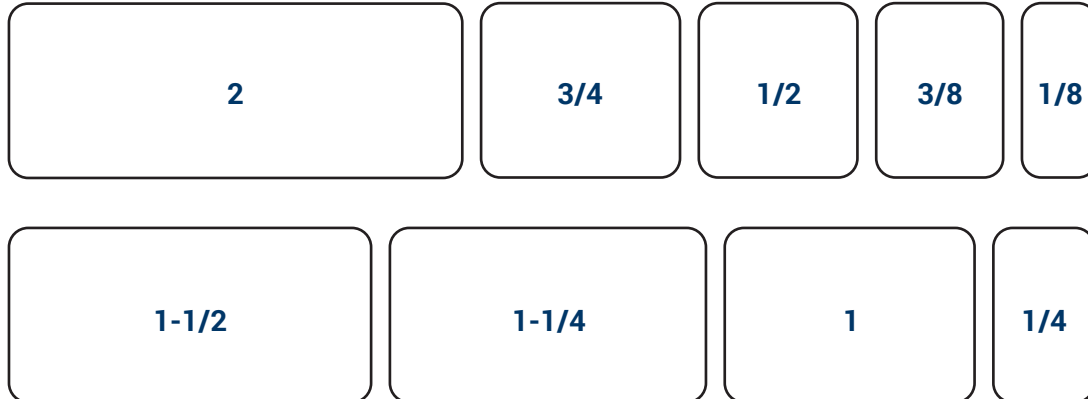

#### Male NST Thread Sizes

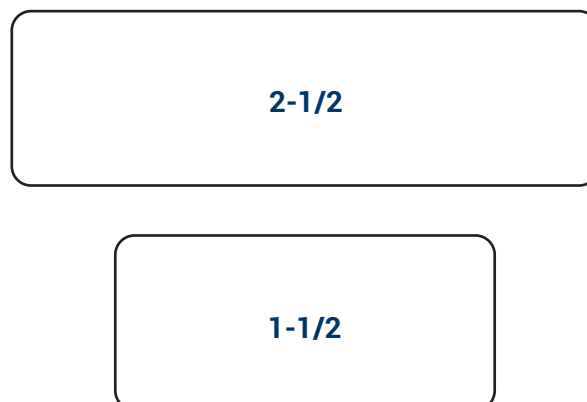

## Thread Dimensions

### Nominal Dimensions of Standard Threads

- ODM = Outside diameter of the male
- IDF = Inside diameter of the female
- TPI = Threads per inch
- GHT (3/4") – 1.0625 ODM, 11-1/2 TPI
- Female NPT (tapered pipe) thread is not available on hose swivel nuts

Size	Pipe O.D.	Tapered Threads		Straight Threads											
		NPT	BSPT <sub>r</sub>	NPSH			NPSM			NST (NH)			BSPP		
		TPI	TPI	TPI	ODM (max)	IDF (min)	TPI	ODM (max)	IDF (min)	TPI	ODM (max)	IDF (min)	TPI	ODM (max)	IDF (min)
1/8"	.405	27.0	28				27.0	0.397	0.358					0.383	0.337
1/4"	.540	18.0	19				18.0	0.526	0.468					0.516	0.450
3/8"	.675	18.0	19				18.0	0.662	0.603					0.656	0.588
1/2"	.840	14.0	14	14.0	0.8248	0.7395	14.0	0.823	0.747					0.825	0.733
3/4"	1.050	14.0	14	14.0	1.0353	0.9500	14.0	1.034	0.958					1.041	0.950
1"	1.315	11.5	11	11.5	1.2951	1.1921	11.5	1.293	1.201	8.0	1.375	1.2246	11	1.309	1.193
1-1/4"	1.660	11.5	11	11.5	1.6399	1.5369	11.5	1.638	1.546				11	1.650	1.534
1-1/2"	1.900	11.5	11	11.5	1.8788	1.7758	11.5	1.877	1.785	9.0	1.990	1.8577	11	1.882	1.766
2"	2.375	11.5	11	11.5	2.3528	2.2498	11.5	2.351	2.259				11	2.347	2.231
2-1/2"	2.875	8.0	11	8.0	2.8434	2.6930	8.0	2.841	2.708	7.5	3.068	2.9104	11	2.960	2.844
3"	3.500	8.0	11				8.0	3.467	3.334	6.0	3.623	3.5306	11	3.460	3.344
4"	4.500	8.0	11				8.0	4.466	4.333	4.0	5.010	4.7111	11	4.450	4.334
4-1/2"										4.0	5.760	5.4611			
5"	5.563	8.0	11				8.0	5.528	5.395	4.0	6.260	5.9602	11	5.450	5.359
6"	6.625	8.0	11				8.0	6.585	6.452	4.0	7.025	6.7252	11	6.450	6.359
8"	8.625	8.0													
10"	10.750	8.0													
12"	12.750	8.0													

### Normal Engagement Length of NPT Thread in Inches (A)

- Dimensions given do not allow for variations in tapping or threading.

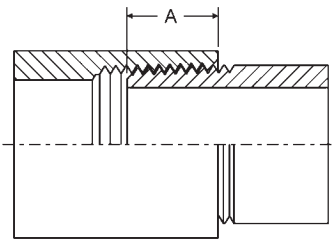

Thread Size	Dimension A
1/8"	1/4"
1/4"	3/8"
3/8"	3/8"
1/2"	1/2"
3/4"	9/16"
1"	11/16"
1-1/4"	11/16"
1-1/2"	11/16"
2"	3/4"
2-1/2"	15/16"
3"	1"
4"	1-1/8"
5"	1-1/4"
6"	1-5/16"
8"	1-7/16"
10"	1-5/8"
12"	1-3/4"

## Thread Sealing Tips

### Thread Sealing Tips

Sealing NPT threads can be an exasperating experience if certain techniques are not followed. The following tips will help alleviate many common problems in thread sealing:

1. Always use some type of sealant (tape or paste) and apply sealant to male thread only. If using a hydraulic sealant, allow sufficient curing time before system is pressurized.
2. When using tape sealant, wrap the threads in a clockwise motion starting at the first thread and, as layers are applied, work towards the imperfect (vanishing) thread. If the system that the connection being made to cannot tolerate foreign matter (i.e. air systems), leave the first thread exposed and apply the tape sealant as outlined above.
3. When using paste sealant, apply to threads with a brush, using the brush to work the sealant into the threads. Apply enough sealant to fill in all the threads all the way around.
4. When connecting one stainless steel part to another stainless steel part that will require future disassembly, use a thread sealant that is designed for stainless steel (see page 1056). This stainless steel thread sealant is also useful when connecting aluminum to aluminum that needs to be disconnected in the future. These two materials gall easily, and if the correct sealant is not used, it can be next to impossible to disassemble.
5. When connecting parts made of dissimilar metals (i.e. steel and aluminum), standard tape or paste sealant performs satisfactory.
6. For sizes 2" and below, tape or paste performs satisfactory. When using thread tape, four wraps (covering all necessary threads) is usually sufficient.
7. For sizes 2-1/2" and above, thread paste is recommended. If thread tape is used, eight wraps (covering all necessary threads) is usually sufficient. Apply more wraps if necessary.
8. For stubborn to seal threads, apply a normal coating of thread paste followed by a normal layer of thread tape.
9. For extremely stubborn to seal threads, apply a normal coating of thread paste followed by a single layer of gauze bandage followed by a normal layer of thread tape.

#### Caution!

When this procedure is done, the connection becomes permanent. Extreme measures will be necessary to disconnect these components. *All other measures to seal the threads should be explored prior to use of this technique.*

10. Over-tightening threads can be just as detrimental as insufficient tightening. For sizes 2" and below, hand tighten the components and, with a wrench, tighten 3 full turns. For sizes 2-1/2" and above, hand tighten the components and, with a wrench, tighten 2 full turns.

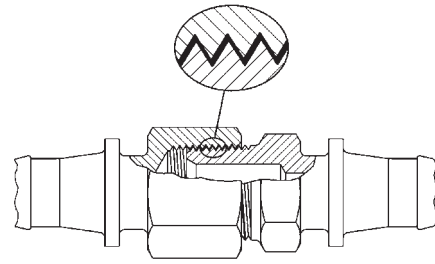

#### Thread Seal Type

- A seal is obtained by applying a sealant to the male thread before engaging.
- The sealant is used to prevent spiral leakage.
- Thread tape or paste is the preferred sealant in this type of application.
- Please refer to page 1055 for thread tape options.

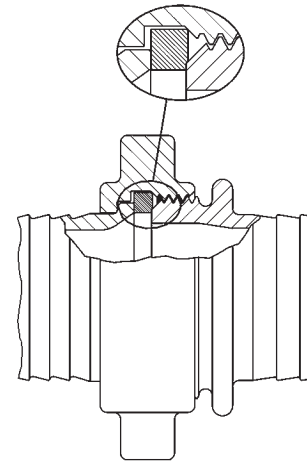

#### Washer Seal Type

- A seal is obtained when the male thread is tightened down onto the washer of the female assembly.
- The washer should be inspected regularly and replaced as needed to prevent leakage.
- Please refer to pages 158, 1037 for replacement washers.

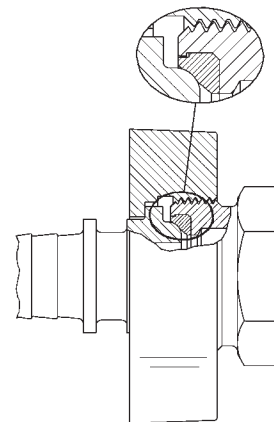

#### Mechanical Seal Type

- A seal is obtained through metal to metal contact or metal to seal contact, i.e. JIC couplings (pages 544 - 549) have a metal to metal seal. Boss® Ground Joint couplings (pages 153 - 155) have a metal to seal contact (shown above).
- The couplings should be retightened as needed to prevent leakage.

### Flange Bolt Tightening Sequence

(Use appropriate gaskets and bolts)

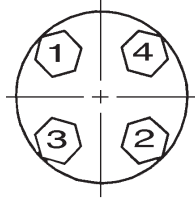

4 Bolt

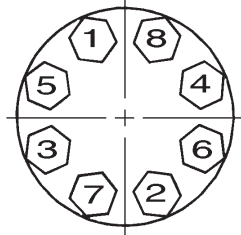

8 Bolt

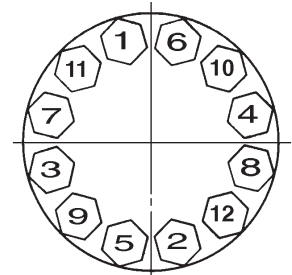

12 Bolt

See page 1133 for drilling dimensions

### Flange Diagrams

#### Threaded Applications

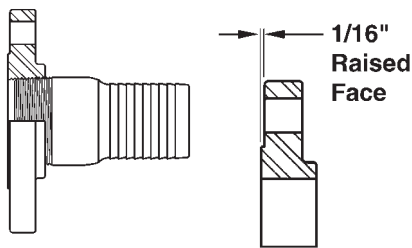

Threaded flange with raised face

#### Welded Applications

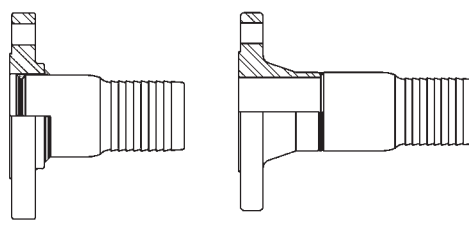

Slip-on flange with raised face

Weld neck flange with raised face

#### Floating Applications (flange free to swivel)

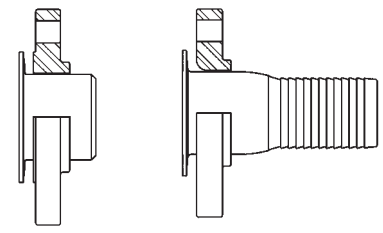

Slip-on flange with raised face

Lap-joint flange

### Dimensions of 150 LB. ASA Steel Flanges

Nominal Pipe Size	Flange O.D.	Thickness <sup>1</sup>	O.D. of Raised Face	Diameter of Bolt Circle	Number of Bolts	Diameter of Bolt Holes	Diameter of Bolts
1"	4-1/4"	9/16"	2"	3-1/8"	4	5/8"	1/2"
1-1/4"	4.62"	5/8"	2-1/2"	3-1/2"	4	5/8"	1/2"
1-1/2"	5"	11/16"	2-7/8"	3-7/8"	4	5/8"	1/2"
2"	6"	3/4"	3-5/8"	4-3/4"	4	3/4"	5/8"
2-1/2"	7"	7/8"	4-1/8"	5-1/2"	4	3/4"	5/8"
3"	7-1/2"	15/16"	5"	6"	4	3/4"	5/8"
4"	9"	15/16"	6-3/16"	7-1/2"	8	3/4"	5/8"
5"	10"	15/16"	7-5/16"	8-1/2"	8	7/8"	3/4"
6"	11"	1"	8-1/2"	9-1/2"	8	7/8"	3/4"
8"	13-1/2"	1-1/8"	10-5/8"	11-3/4"	8	7/8"	3/4"
10"	16"	1-3/16"	12-3/4"	14-1/4"	12	1"	7/8"
12"	19"	1 1/4"	15"	17"	12	1"	7/8"

<sup>1</sup> 1/16" raised face is included in the thickness

### Dimensions of Tank Truck Flanges (TTMA Drilling)

Nominal Pipe Size	Flange O.D.	Thickness <sup>1</sup>	Diameter of Bolt Circle	Number of Bolts	Diameter of Bolt Holes	Diameter of Bolts
3"	5-5/8"	3/8"	4-7/8"	8	7/16"	3/8"
4"	6-5/8"	3/8"	5-7/8"	8	7/16"	3/8"
6"	8-7/8"	3/8"	8-1/8"	12	7/16"	3/8"

<sup>1</sup> Listed thickness is for aluminum flanges



## ANSI Flange Dimensions

150 lb. Standard

Nominal Pipe Size	Outside Diameter Flange	Flange Thickness	Drill Template		
			Number Holes	Diameter Bolts	Bolt Circle
1/2"	3-1/2"	7/16"	4	1/2"	2-3/8"
3/4"	3-7/8"	1/2"	4	1/2"	2-3/4"
1"	4-1/4"	9/16"	4	1/2"	3-1/8"
1-1/4"	4-5/8"	5/8"	4	1/2"	3-1/2"
1-1/2"	5"	11/16"	4	1/2"	3-7/8"
2"	6"	3/4"	4	5/8"	4-3/4"
2-1/2"	7"	7/8"	4	5/8"	5-1/2"
3"	7-1/2"	15/16"	4	5/8"	6"
3-1/2"	8-1/2"	15/16"	8	5/8"	7"
4"	9"	15/16"	8	5/8"	7-1/2"
5"	10"	15/16"	8	3/4"	8-1/2"
6"	11"	1"	8	3/4"	9-1/2"
8"	13-1/2"	1-1/8"	8	3/4"	11-3/4"
10"	16"	1-3/16"	12	3/4"	14-1/4"
12"	19"	1-1/4"	12	3/4"	17"

300 lb. Standard

Nominal Pipe Size	Outside Diameter Flange	Flange Thickness	Drill Template		
			Number Holes	Diameter Bolts	Bolt Circle
1/2"	3-3/4"	9/16"	4	1/2"	2-5/8"
3/4"	4-5/8"	5/8"	4	5/8"	3-1/4"
1"	4-7/8"	11/16"	4	5/8"	3-1/2"
1-1/4"	5-1/4"	3/4"	4	5/8"	3-7/8"
1-1/2"	6-1/8"	13/16"	4	3/4"	4-1/2"
2"	6-1/2"	7/8"	8	5/8"	5"
2-1/2"	7-1/2"	1"	8	3/4"	5-7/8"
3"	8-1/4"	1-1/8"	8	3/4"	6-5/8"
3-1/2"	9"	1-3/16"	8	3/4"	7-1/4"
4"	10"	1-1/4"	8	3/4"	7-7/8"
5"	11"	1-3/8"	8	3/4"	9-1/4"
6"	12-1/2"	1-7/16"	12	3/4"	10-5/8"
8"	15"	1-5/8"	12	7/8"	13"
10"	17-1/2"	1-7/8"	16	1"	15-1/4"
12"	20-1/2"	2"	16	1-1/8"	17-3/4"

600 lb. Standard

Nominal Pipe Size	Outside Diameter Flange	Flange Thickness	Drill Template		
			Number Holes	Diameter Bolts	Bolt Circle
1/2"	3-3/4"	9/16"	4	5/8"	2-5/8"
3/4"	4-5/8"	5/8"	4	3/4"	3-1/4"
1"	4-7/8"	11/16"	4	3/4"	3-1/2"
1-1/4"	5-1/4"	13/16"	4	3/4"	3-7/8"
1-1/2"	6-1/8"	7/8"	4	7/8"	4-1/2"
2"	6-1/2"	1"	8	3/4"	5"
2-1/2"	7-1/2"	1-1/8"	8	7/8"	5-7/8"
3"	8-1/4"	1-1/4"	8	7/8"	6-5/8"
3-1/2"	9"	1-3/8"	8	1"	7-1/4"
4"	10-7/5"	1-1/2"	8	1"	8-1/2"
5"	13"	1-3/4"	8	1-1/8"	10-1/2"
6"	14"	1-7/8"	12	1-1/8"	11-1/2"
8"	16-1/2"	2-3/16"	12	1-1/4"	13-3/4"
10"	20"	2-1/2"	16	1-3/8"	17"
12"	22"	2-5/8"	20	1-3/8"	19-1/4"

900 lb. Standard

Nominal Pipe Size	Outside Diameter Flange	Flange Thickness	Drill Template		
			Number Holes	Diameter Bolts	Bolt Circle
1/2"	4-3/4"	7/8"	4	7/8"	3-1/4"
3/4"	5-1/8"	1"	4	7/8"	3-1/2"
1"	5-7/8"	1-1/8"	4	1"	4"
1-1/4"	6-1/4"	1-1/8"	4	1"	4-3/8"
1-1/2"	7"	1-1/4"	4	1-1/8"	4-7/8"
2"	8-1/2"	1-1/2"	8	1"	6-1/2"
2-1/2"	9-5/8"	1-5/8"	8	1-1/8"	7-1/2"
3"	9-1/2"	1-1/2"	8	1"	7-1/2"
3-1/2"	11-1/2"	1-3/4"	8	1-1/4"	9-1/4"
4"	13-3/4"	2"	8	1-3/8"	11"
6"	15"	2-3/16"	12	1-1/4"	12-1/2"
8"	18-1/2"	2-1/2"	12	1-1/2"	15-1/2"
10"	21-1/2"	2-3/4"	16	1-1/2"	18-1/2"
12"	24"	3-1/8"	20	1-1/2"	21"



## Pipe Dimensions

### Dimensions of Seamless and Welded Steel Pipe ASA-B36.10 and B36.19

Nominal Pipe Size	O.D. (inches)	Pipe Schedule Wall Thickness												
		10	20	30	Stand.	40	60	Extra Strong	80	100	120	140	160	XXX Strong
1/8"	0.405	0.049	---	---	0.068	0.068	---	0.095	0.095	---	---	---	---	---
1/4"	0.540	0.065	---	---	0.088	0.088	---	0.119	0.119	---	---	---	---	---
3/8"	0.675	0.065	---	---	0.091	0.091	---	0.126	0.126	---	---	---	---	---
1/2"	0.840	0.083	---	---	0.109	0.109	---	0.147	0.147	---	---	---	0.188	0.294
3/4"	1.050	0.083	---	---	0.113	0.113	---	0.154	0.154	---	---	---	0.219	0.308
1"	1.315	0.109	---	---	0.133	0.133	---	0.179	0.179	---	---	---	0.250	0.358
1-1/4"	1.660	0.109	---	---	0.140	0.140	---	0.191	0.191	---	---	---	0.250	0.382
1-1/2"	1.900	0.109	---	---	0.145	0.145	---	0.200	0.200	---	---	---	0.281	0.400
2"	2.375	0.109	---	---	0.154	0.154	---	0.218	0.218	---	---	---	0.344	0.436
2-1/2"	2.875	0.120	---	---	0.203	0.203	---	0.276	0.276	---	---	---	0.375	0.552
3"	3.500	0.120	---	---	0.216	0.216	---	0.300	0.300	---	---	---	0.438	0.600
3-1/2"	4.000	0.120	---	---	0.226	0.226	---	0.318	0.318	---	---	---	---	---
4"	4.500	0.120	---	---	0.237	0.237	---	0.337	0.337	---	0.438	---	0.531	0.674
5"	5.563	0.134	---	---	0.258	0.258	---	0.375	0.375	---	0.500	---	0.625	0.750
6"	6.625	0.134	---	---	0.280	0.280	---	0.432	0.432	---	0.562	---	0.719	0.864
8"	8.625	0.148	0.250	0.277	0.322	0.322	0.406	0.500	0.500	0.594	0.719	0.812	0.906	0.873
10"	10.750	0.165	0.250	0.307	0.365	0.365	0.500	0.500	0.594	0.719	0.844	1.000	1.125	1.000
12"	12.750	0.180	0.250	0.330	0.375	0.406	0.562	0.500	0.688	0.844	1.000	1.125	1.312	1.000

### Definitive Cross-Reference from NPS to DN Specification Sizes

Nominal Pipe Size	DN	O.D. (inches)	Pipe Schedule Wall Thickness													
			5S	5	10S	10	20	30	40S	40	60	80S	80	100	120	160
1/8"	6	0.405	---	0.035	---	0.049	---	0.057	---	0.068	---	---	0.095	---	---	---
1/4"	8	0.540	---	0.049	---	0.065	---	0.073	---	0.088	---	---	0.119	---	---	---
1/2"	15	0.840	---	0.065	---	0.083	---	0.095	---	0.109	---	---	0.147	---	0.170	0.188
3/4"	20	1.050	---	0.065	---	0.083	---	0.095	---	0.113	---	---	0.154	---	0.170	0.219
1"	25	1.315	---	0.065	---	0.109	---	0.114	---	0.133	---	---	0.179	---	0.200	0.250
1-1/4"	32	1.660	---	0.065	---	0.109	---	0.117	---	0.140	---	---	0.191	---	0.215	0.250
1-1/2"	40	1.900	---	0.065	---	0.109	---	0.125	---	0.145	---	---	0.200	---	0.225	0.281
2"	50	2.375	---	0.065	---	0.109	---	---	---	0.154	---	---	0.218	---	0.250	0.344
2-1/2"	65	2.875	---	0.083	---	0.120	---	---	---	0.203	---	---	0.276	---	0.300	0.375
3"	80	3.500	---	0.083	---	0.120	---	---	---	0.216	---	---	0.330	---	0.350	0.438
4"	100	4.500	---	0.083	---	0.120	---	---	---	0.237	0.281	---	0.377	---	0.437	0.531
5"	125	5.563	---	0.109	---	0.134	---	---	---	0.258	---	---	0.375	---	0.500	0.625
6"	150	6.625	---	0.109	---	0.134	---	---	---	0.280	---	---	0.432	---	0.562	0.719
8"	200	8.625	---	0.109	---	0.148	0.250	0.277	---	0.322	0.406	---	0.500	0.593	0.718	0.906
10"	250	10.750	0.134	0.134	0.165	0.165	0.250	0.307	0.365	0.365	0.500	0.500	0.593	0.718	0.843	---
12"	300	12.750	0.156	0.165	0.180	0.180	0.250	0.330	0.375	0.406	0.500	0.500	0.687	0.843	1.000	---





## Valve Selection Guide

### Ball Valve

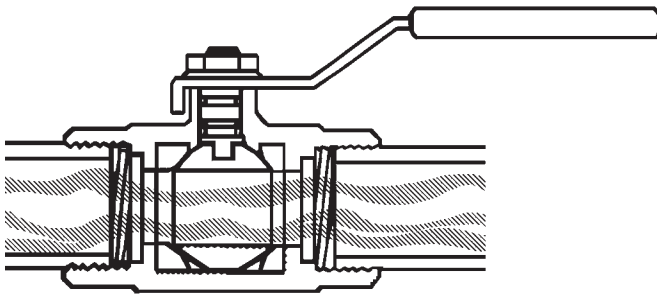

- Can be used for on and off service or throttling
- When positive shut-off is necessary
- Where a low valve profile is necessary
- Only 90° rotation from open to fully closed (quick opening)
- Handle position is a quick indication of whether valve is open or closed.
- Full port ball valves do not resist flow

### Butterfly Valve

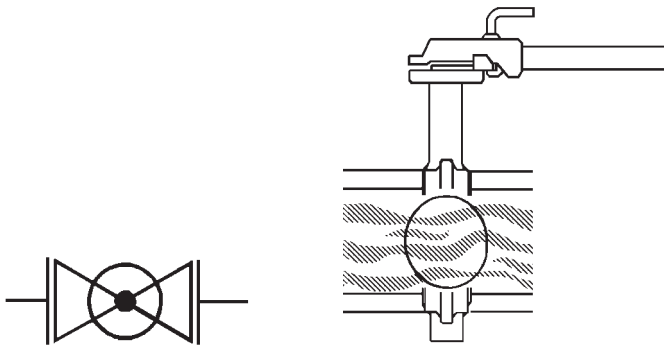

- Where positive shut-off is necessary
- Primarily for fully open or fully closed applications
- May be used for throttling
- Only 90° rotation from open to fully closed
- Lightweight
- Easy to install
- Less costly than an iron body gate valve

### Gate Valve

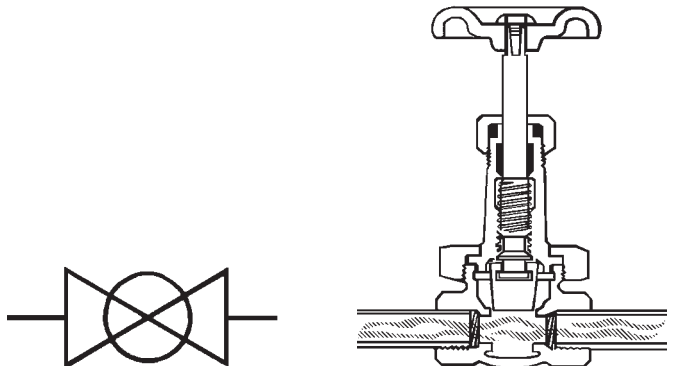

- For fully open or fully closed service - not for throttling
- For minimum line pressure drop
- For minimum fluid entrapment in the line
- For relatively infrequent operation

### Check Valve

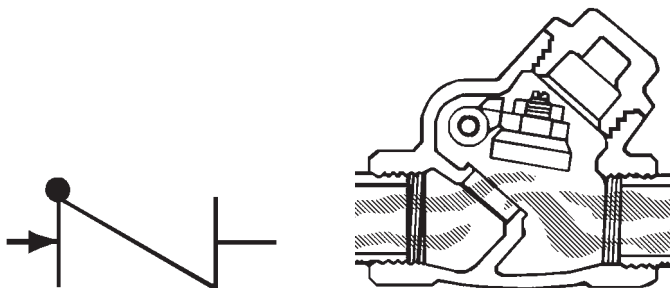

- To control the direction of flow and for quick, automatic reactions to flow change. Swing check valves are used when a minimum resistance to flow is required.
- Swing check valves are recommended for use in conjunction with gate valves. They should not be used in a rapid recycling system such as reciprocating pumps or air compressor service where they could cause chatter and damaging vibration.

### Globe Valve

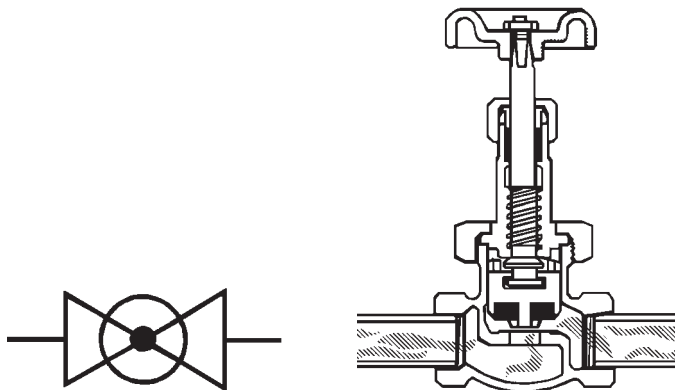

- For regulation (throttling) of flow
- For frequent operation; short stem travel reduces operator's time
- Where some line resistance is acceptable

### 3-Way Ball Valve Flow Options

'T' Pattern, Side Entry

Top view

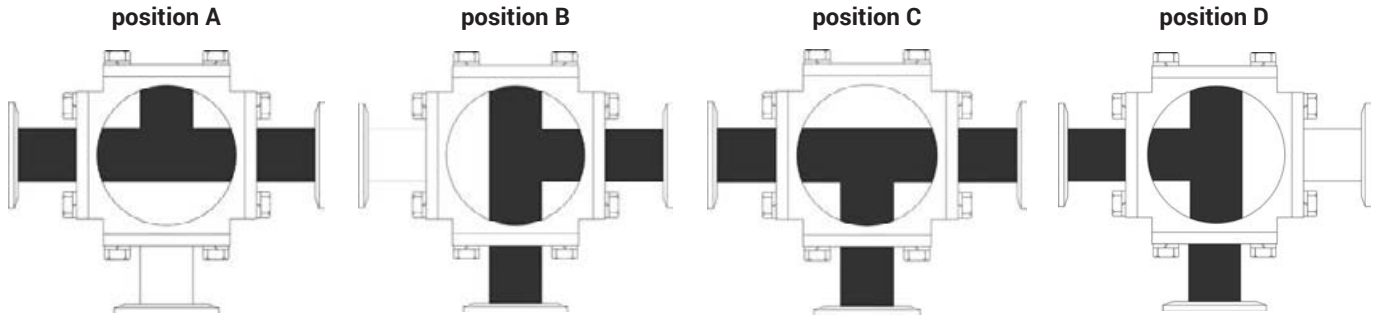

Number	Rotation	Flow Plan Options
1	90°	A, B
2	90°	B, C
3	90°	C, D
4	90°	A, D
5	180°	A, B, C
6	180°	B, C, D
7	180°	A, C, D
8	180°	A, B, D

'L' Pattern, Side Entry

Top view

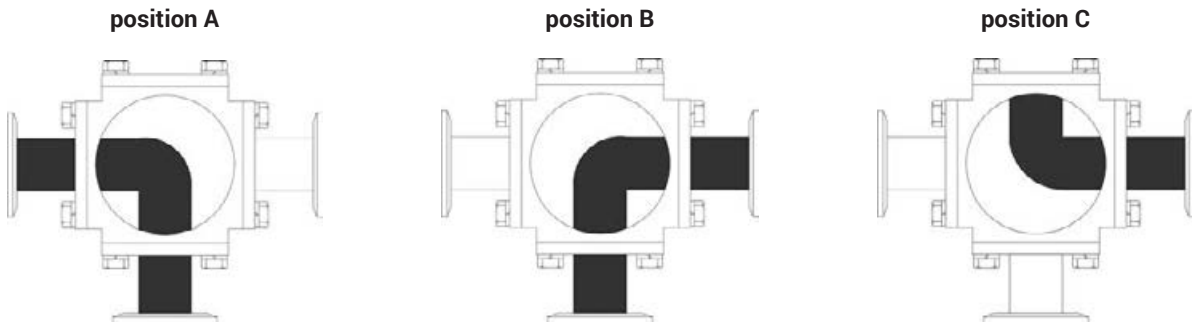

Number	Rotation	Flow Plan Options
1	90°	A, B
2	180°	A, B, C

**BPE Dimensions and Tolerances (DT) Table Call Out**

Part Description	2016 DT ASME-BPE 2016	2019 DT ASME-BPE 2019
T2S - 90° elbow	DT-4.1.1-1	DT-4.1.1-1
T2CM - 90° elbow, clamp one end	DT-4.1.1-2	DT-4.1.1-2
T2CMP - 90° elbow, clamped	DT-4.1.1-3	DT-4.1.1-3
T2KS - 45° elbow	DT-4.1.1-4	DT-4.1.1-4
T2KM - 45° elbow, clamp one end	DT-4.1.1-5	DT-4.1.1-5
T2KMP - 45° elbow, clamped	DT-4.1.1-6	DT-4.1.1-6
T7WWW - equal tee	DT-4.1.2-1	DT-4.1.2-1
T7WWMS - short outlet tee	DT-4.1.2-2	DT-4.1.2-2
T7MP - equal tee, clamped	DT-4.1.2-4	DT-4.1.2-4
T7MPS - short outlet tee, clamped	DT-4.1.2-5	DT-4.1.2-5
T7RWWW - reducing tee	DT-4.1.2-6	DT-4.1.2-6
T7RWWMS - short outlet reducing tee	DT-4.1.2-7	DT-4.1.2-7
T7RMP - reducing tee, clamped	DT-4.1.2-8	DT-4.1.2-8
T7RMPS - short outlet reducing tee, clamped	DT-4.1.2-9	DT-4.1.2-9
T7IWWMS - instrument tee	DT-4.1.2-10	DT-4.1.2-10
T7IMPS - instrument tee, clamped	DT-4.1.2-11	DT-4.1.2-11
T31W - long concentric reducer	DT-4.1.3-1	N/A
T32W - long eccentric reducer	DT-4.1.3-1	N/A
2211C - short concentric reducer	DT-4.1.3-1	DT-4.1.3-1
2211E - short eccentric reducer	DT-4.1.3-1	DT-4.1.3-1
T31M - long concentric reducer, clamp big end	DT-4.1.3-2	N/A
T32M - long eccentric reducer, clamp big end	DT-4.1.3-2	N/A
2226C - short concentric reducer, clamp big end	DT-4.1.3-2	DT-4.1.3-2
2226E - short eccentric reducer, clamp big end	DT-4.1.3-2	DT-4.1.3-2
T3114MP - long concentric reducer, clamped	DT-4.1.3-3	N/A
T3214MP - long eccentric reducer, clamped	DT-4.1.3-3	N/A
2221C - short concentric reducer, clamped	DT-4.1.3-3	DT-4.1.3-3
2221E - short eccentric reducer, clamped	DT-4.1.3-3	DT-4.1.3-3
TL14AM7 - long weld clamp ferrule	DT-4.1.4-1	DT-4.1.4-1
T14WMP - short weld clamp ferrule	DT-4.1.4-1	DT-4.1.4-1
T16W - weld cap	DT-4.1.5-1	DT-4.1.5-1
T16AMP - end cap, clamped	DT-4.1.5-2	DT-4.1.5-2

Pipe Gasket Sizing Guide

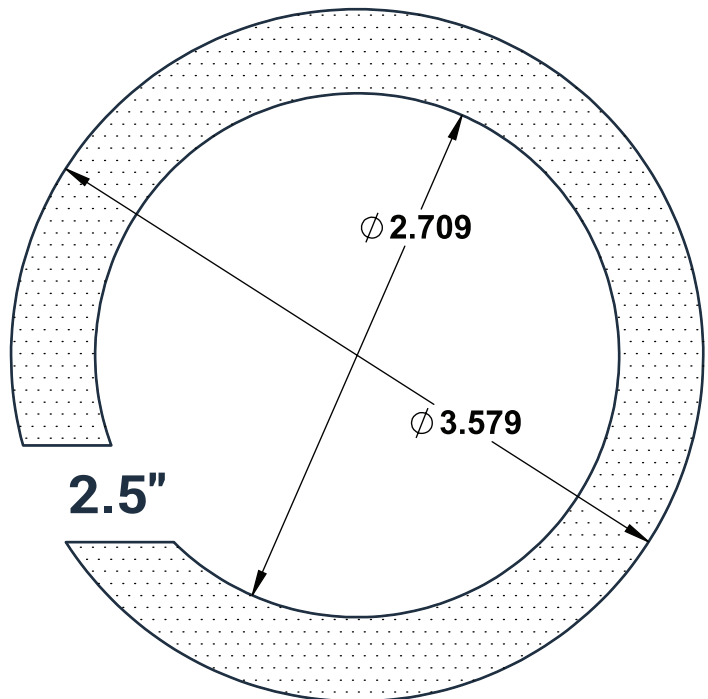
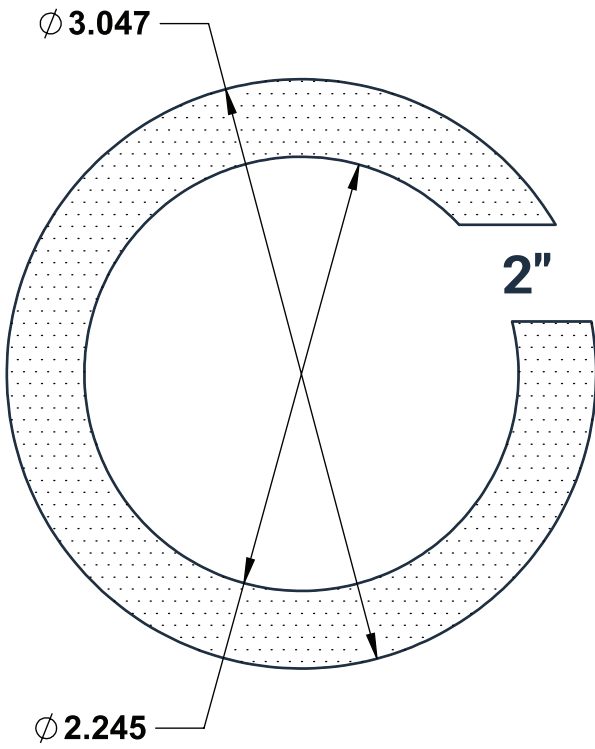
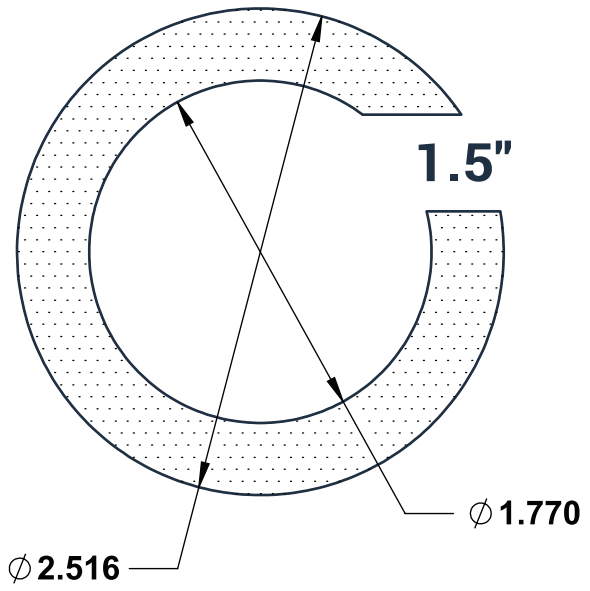
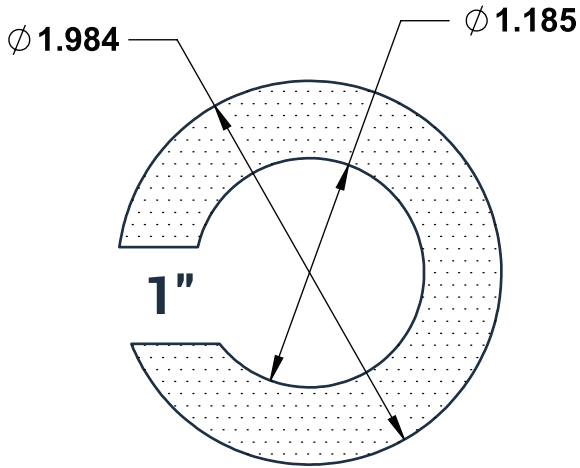

### Pipe Gasket Sizing Guide

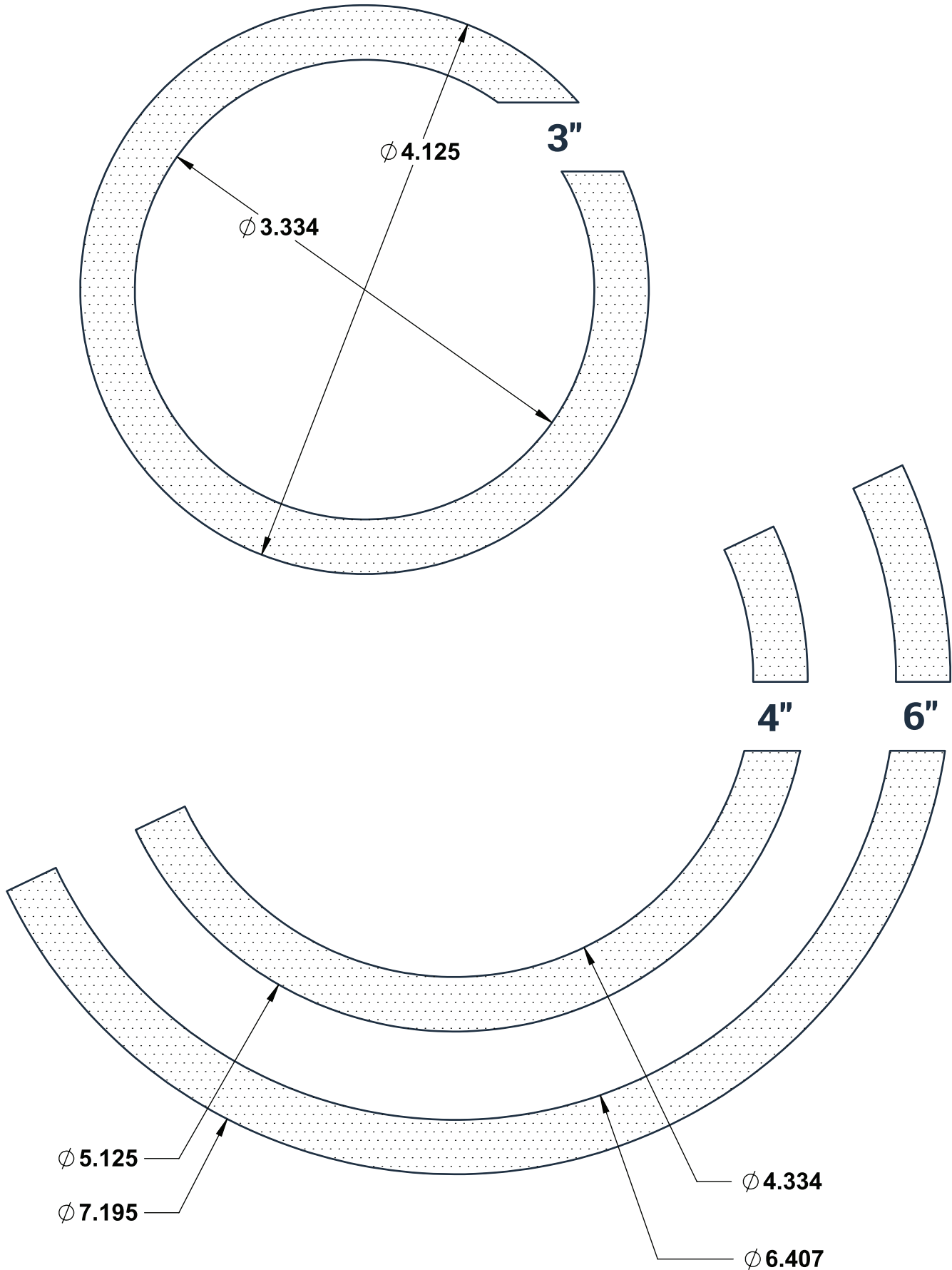

**Particulate Reference Chart**

**316 Square Mesh Wire Cloth Gasket Information**

Mesh	Micron Equivalent	Opening Width	Wire Diameter	Openings per Square Inch
4	5400	.215	.035	16
6	3221	.132	.035	36
8	2441	.097	.028	64
9	2089	.083	.025	81
10	1887	.075 <sup>1</sup>	.023	100
12	1510	.050	.023	144
14	1283	.051 <sup>2</sup>	.020	196
16	1082	.0455	.016	256
20	855	.034	.016	400
30	427	.017	.016	900
35	422	.0168	.0118	1275
40	377	.015	.010	1600
50	276	.011	.009	2500
60	226	.009 <sup>3</sup>	.0075	3600
80	176	.007 <sup>3</sup>	.0055	6400
100	151	.006 <sup>3</sup>	.0045	10,000
120	120	.0048 <sup>3</sup>	.0035	14,400
150	103	.0041	.0026	22,500
200	73	.0029	.0021	40,000



<sup>1</sup> Standard size for clamp style gaskets

<sup>2</sup> Standard size for bevel seat size gaskets

<sup>3</sup> Available in only 1", 1-1/2" and 2" sizes

NOTE: Special order parts, minimum order quantities required

**Perforated 316 Disc Information**

Hole Diameter	Micron Equivalent	Open Area
.020"	503	30%
.033" <sup>1</sup>	803	28%
.063"	1573	23%
.100"	2517	33%
.125"	3146	40%
.250"	6350	58%



<sup>1</sup> Standard size for clamp style

NOTE: 1 micron = .00003937 inches

Special order - minimums apply

### Clamp Fittings and Gasket Sizing Guide

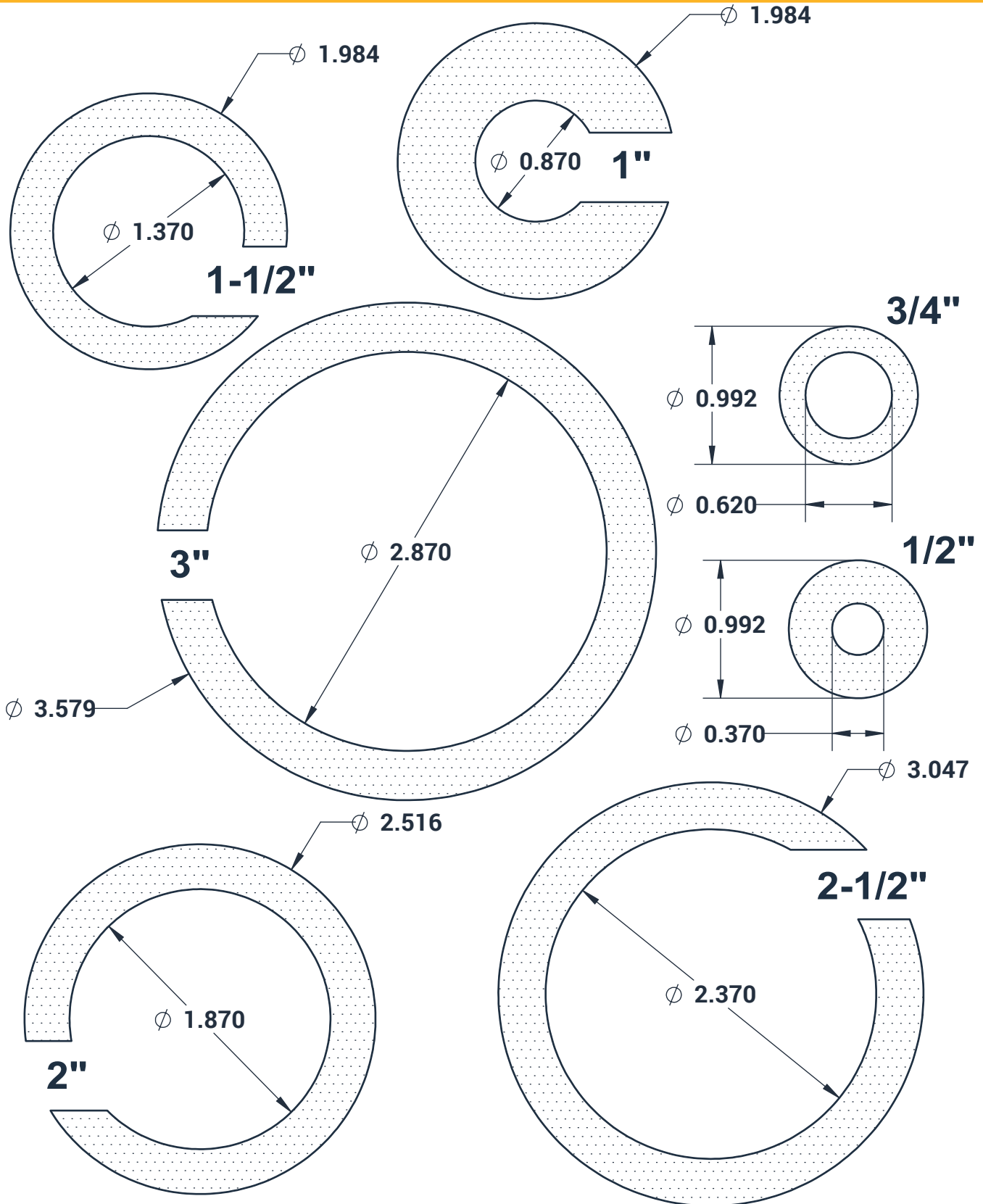

Sanitary Size	O.D. of Clamp End (in)	I.D. of Fitting (in)
1/2"	0.992	0.370
3/4"	0.992	0.620
1"	1.984	0.870
1-1/2"	1.984	1.370
2"	2.516	1.870
2-1/2"	3.047	2.370

Sanitary Size	O.D. of Clamp End (in)	I.D. of Fitting (in)
3"	3.579	2.870
4"	4.682	3.834
6"	6.562	5.782
8"	8.602	7.782
10"	10.570	9.782
12"	12.570	11.760

Clamp Fittings and Gasket Sizing Guide

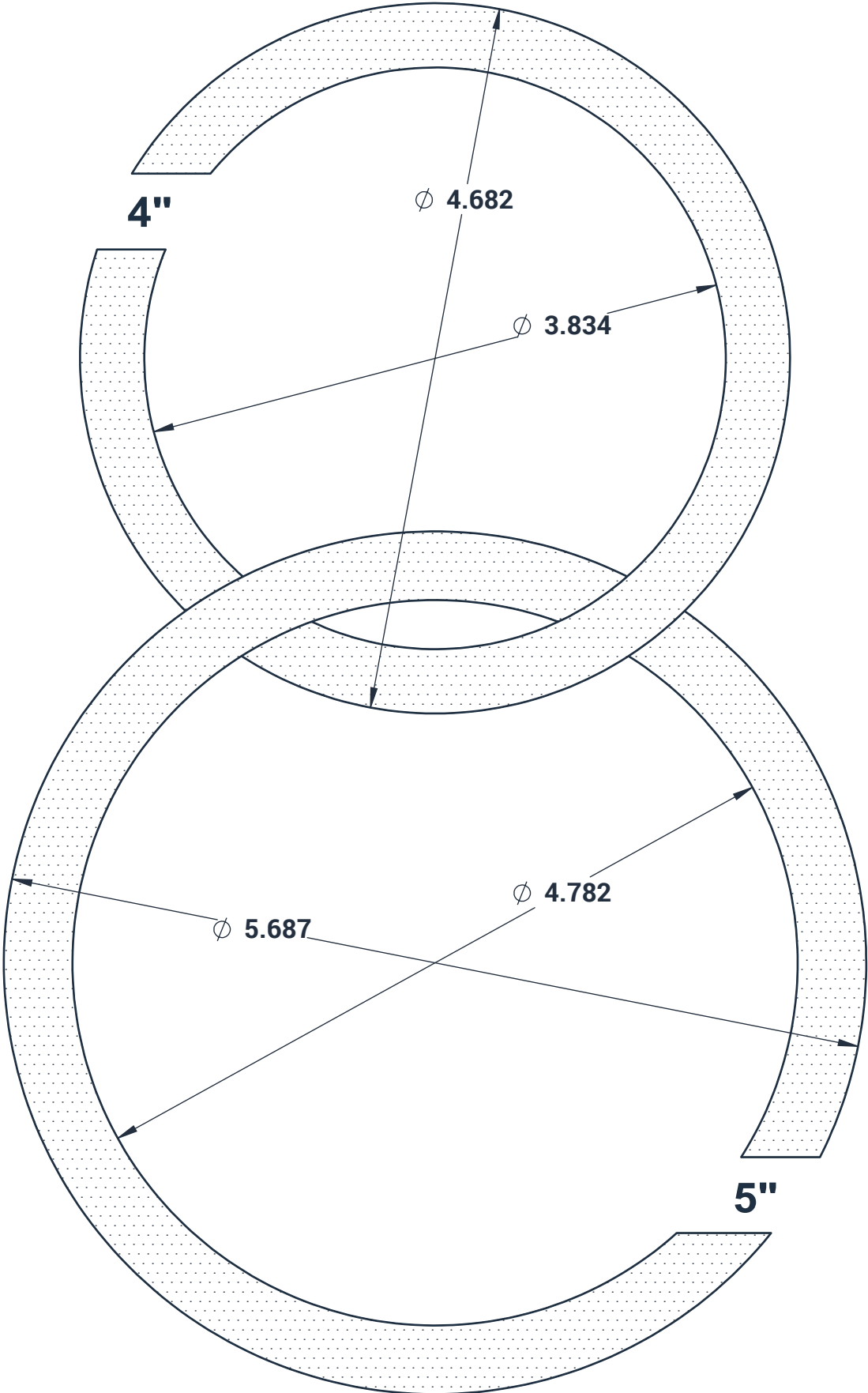



### Clamp Fittings and Gasket Sizing Guide

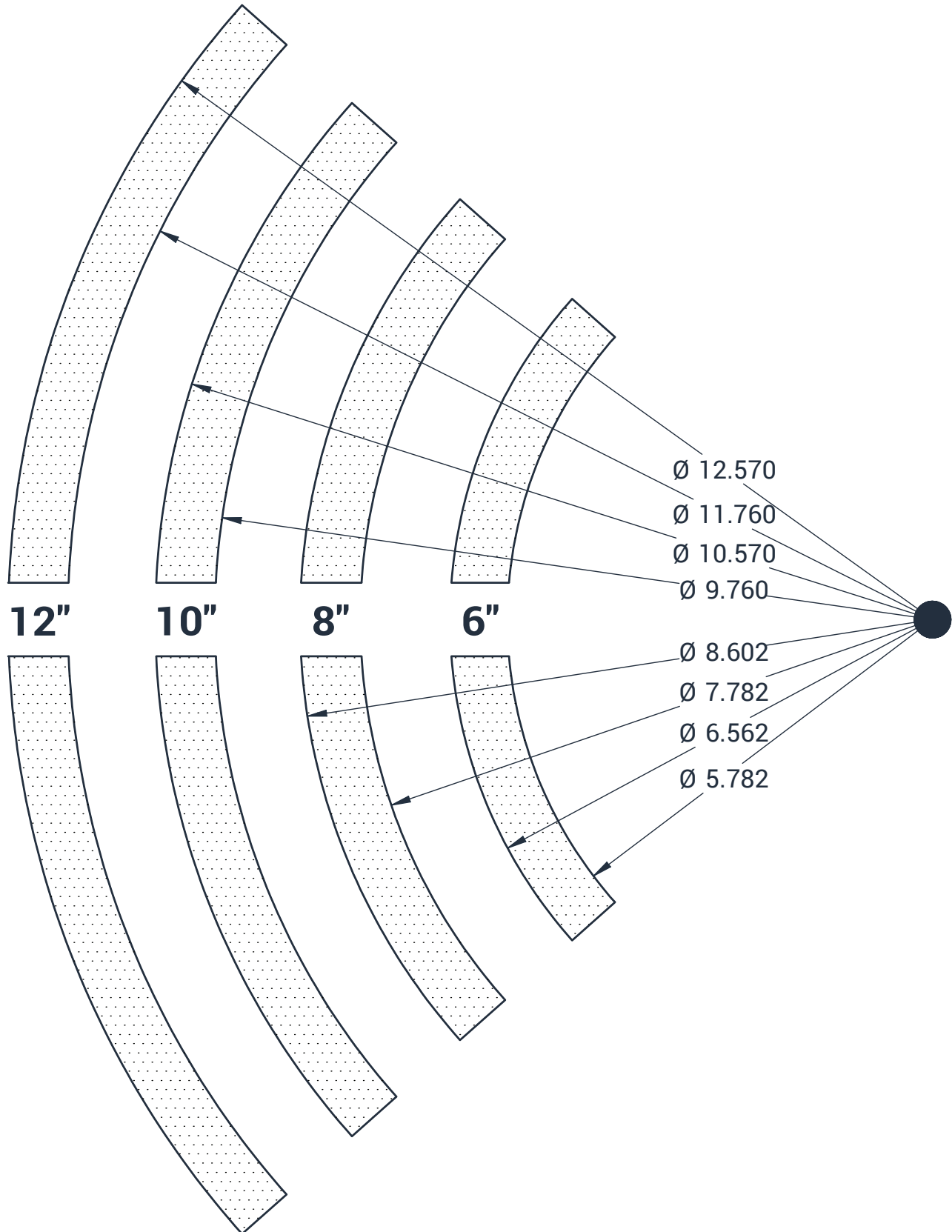

	Page #	Adapters (cont.)	Page #		Page #
<b>A</b>		Vapor recovery .....	120, 1028, 1033	<b>B</b>	
Abrasion resistant inserts .....	32, 35, 73	Weld .....	622	Backflow preventer .....	417
Adapters		with grounding tab .....	1030	Ball	
Aviation .....	104	Adjustable hose bumper stops .....	287	Cone check valves .....	912
Ball seat .....	452, 929	Aero-seal® .....	461, 462	Mini	
Bayonet style dry disconnect .....	96, 97, 1039, 1040	Air		Valves .....	880
Bevel seat .....	636	Blow guns .....	279, 281	Swivel connector	
Boss® .....	156	Check valves .....	913, 914	with Air Chief plugs .....	214
Boss LPS		Couplings .....	184, 187, 188, 190, 191, 192, 194, 195, 196, 1098	Swivels .....	285
Flanged .....	170, 171	Gauges, process .....	347	Valves	
Flanged, 45° elbow .....	170	Hose, polyurethane .....	282, 283, 1088	3-piece	
Flanged, short .....	170	Hose reel, manual .....	287	FNPT .....	884
Flanged, straight .....	170	Hose reel, retractable .....	286, 287	Socket weld .....	884
Flanged to male NPT, 125# .....	171	Hose, self-storing .....	282, 283, 1088	3-way .....	897
Flanged to weld, 150# .....	171	Hose, spring driven .....	286, 287	L flow .....	881
Brass .....	450, 452	Receiver manifold, ASME .....	264	T flow .....	881
Cam & groove .....	7, 8, 29, 30, 32, 43, 44, 45, 46, 51, 55, 56, 57, 61, 63, 75, 79, 81, 82, 85, 86, 88, 94, 119, 120, 176, 177, 1033, 1038	Tool lubricant .....	267, 1089, 1100	150# flanged .....	898
Clamp .....	608	Air brake .....	234, 235, 236, 237, 238, 239	Bronze .....	875, 876, 877
Drum thread .....	916	Air Chief		Carbon steel .....	896
Dry disconnect .....	94, 95, 100	ARO .....	223, 224	Dixon® MannTek full flow .....	895, 896
MannTek .....	100, 101, 102, 104	Automotive .....	221, 222	High pressure .....	897
Dry gas .....	102	Ball swivel connectors		with NPT tap for drain .....	877
European .....	646, 648	with Air Chief plugs .....	214	Ball Valves	
Fill pipe .....	1028	Blow guns .....	277, 1087	3-Piece Ball Valves	
Fire .....	789, 795, 796, 798, 799, 800, 801, 802, 803, 806, 807, 808, 810, 812, 813, 814, 826, 834	Industrial .....	215, 216, 217, 218	encapsulated, stainless	
Hydrant .....	800, 801, 802, 803, 814	Lincoln .....	225	2-Way 3 Piece .....	736
GHT .....	423, 424	Quick disconnect .....	215, 216, 218	non-encapsulated, stainless	
Gravity drop .....	1029	Air King® .....	265	2-way 3 Piece .....	737
Hydraulic		Clamps .....	185, 1096	Band clamp	
BSPP (British thread) .....	556	Compressor Y .....	267	Band and buckle .....	472
Code 61 / Code 62 .....	566	Ferrules .....	184, 185	Set screw .....	472
JIC .....	542, 543, 557	Global .....	182, 183, 185	Tools .....	474
NPTF .....	539, 541, 542, 544, 545-549, 551, 552, 553, 554, 555, 557	Lanyards .....	186, 1095	Center punch .....	469
ORB .....	539, 541, 542, 543	Safety clip .....	186, 1095	FO-series .....	469
I-Line/Q-Line .....	642	Safety pin .....	186	F-series .....	469
Inserts .....	32, 73	Washers .....	186, 1095	K-series .....	470
LIQUIfit™ .....	994	with ferrules .....	184	Smooth ID .....	471
LP gas .....	971, 972	with gauge port .....	184	Tools .....	473
Oxy-acetylene .....	458	Air line		Tote .....	472
Pipe .....	925, 926, 929	Shut-off valves .....	314, 913, 914	Barbed push-on fittings .....	221, 222, 438, 439, 440, 441, 442, 443, 444
Pipe size .....	666	Swivels .....	285	Bayonet style dry disconnects .....	96, 97, 1039, 1040
Pump .....	925	Air tool lubricants .....	267, 1089, 1100	Bell reducers .....	919, 920, 964
Reducing .....	964	ANSI split flange adapter .....	964	Bent stem swivels .....	227
Side seal .....	1021	Anti-freeze lubricant .....	267, 1100	Bevel seat fittings	
Steam service .....	101	API		Adapters	
Tank car .....	126	Certified couplings .....	584	Rubber hose .....	636
Tank transport .....	1038	Couplers .....	139	Tygon® hose .....	636
Tank truck .....	118, 119, 1023, 1031, 1032	Dust cap .....	1029	Caps .....	636
Male adapter .....	1021, 1024	Rack cords .....	142, 144	Elbows	
Tank cabinet weld-on .....	1022	ARO-speed quick disconnects .....	223, 224	45° .....	634
Tuff-Lite® .....	939, 1008	ASME air receiver manifold .....	263, 264, 265	90° .....	634
		Automatic		Ferrules	
		Drain .....	311	Plain	
		Safety couplers .....	220		
		Automotive quick disconnects .....	202, 203, 214, 221, 222, 1086		
		Aviation, dry couplings .....	103, 104		
		Axe .....	1066		
		Axial restraint pipe couplings .....	953		

Bevel seat fit. (cont.)	Page #	Bolted fittings	Page #	Brass (cont.)	Page #
Heavy wall tank	632	Gaskets	944	Compression fittings	978-983
Light wall tank	632	Boss®		Connectors	228, 230, 233, 234, 240, 246, 248, 256, 257, 258
Long	631	Ductile flanges	955	Crimper tools	434, 435, 436, 437
Recessed	631	Boss-Lock		Dies	434, 436, 437
Recessless	631	Cam & groove	36, 37, 41, 48, 49, 54, 55, 64-66, 72, 73, 74	Dual lock	194, 195
Short	631	EZ Boss-Lock	6, 24, 34, 37, 38, 42, 49, 54, 56	Elbows	228, 231, 235, 236, 241, 242, 247, 249, 251, 256, 258
Threaded		Boss		External drains	274
Heavy wall tank	633	Adapters	156, 175	Ferrules	433, 446, 447, 448
Light wall tank	633	Assembly information	152	Garden hose fittings	418-424, 441, 1078, 1079, 1080
Long	632	Clamps	161, 162, 1097	Gauges	347, 353
Recessed	633	Double spuds	155, 163	Hex plugs	455, 938
Recessless	633	Female spuds	154, 157, 163	Jack chains with S-hooks	73
Short	632	Fittings with ferrules	155	Lead free fittings	455
Gaskets	682, 683	Ground joint air hammer couplings	163	Adapters - NPT	449, 920, 925
Hex nuts	630	Hose menders	160	Female hex couplings - NPT	449, 922
Hex wrenches	630	Knurled nut	154	Hex nipples	451
Single sided	630	Male spuds	155, 163	Hex socket	455
Two sided	630	Male stems	159, 160	Male hose x male hose x female pipe	423
Reducers		Spud x hose shank	160	Pipe cap - NPT	454, 937
Concentric	635	Stems		Pipe nipples	450, 451, 927
BioPharm fittings (BPE)		Ground joint	153	Reducer bushings - NPT	449, 925
Adapters	650	Ground joint air hammer	163	Reducer couplers - NPT	449, 920
Caps	649	Washer seal	157	Long shank fittings	374, 375
Weld	649	Washers	158	LP gas hose couplings and adapters	971
Elbows		Washer seal couplings	157	Male swivel inserts	426
Clamp		Wing nut caps	156	Nickel plated push-in fittings	246, 247, 248, 249, 250, 252
45°	652	Wing nuts	154, 163	Nozzles	
Weld		Boss LPS		Fog	779
45°	652	Adapters	170, 171	Global approved	779
88°	652	45° elbow	170	Nylon/nickel-plated push-in fittings	248, 249, 250
90°	651	Short	170	Push-in fittings	240, 241, 242, 243
92°	652	Straight	170	Push-on fittings	438, 439, 440, 441, 442, 443, 444, 445
Ferrules	651	Butterfly valve	174	Reusable fittings	446, 447, 448
Reducers		Caps	169	SAE 45° flare fittings	984, 985, 986
Clamp		Complete assembly	165	Sash chains with pull rings	72
Concentric	658, 660, 661, 662	Female fittings	165	Short shank fittings	370, 371
Eccentric	659, 660, 663	Ferrules	166	Swivels	420, 421, 424, 426, 428, 431, 432, 438, 440, 441, 442, 443, 444, 447
Weld		Frac fittings	165, 166	Tees	229, 232, 233, 237, 242, 243, 247, 250, 257, 430, 453, 454, 934, 936
Concentric	658, 660, 661	Hammer union caps and plugs	169	Threaded bell reducers	920
Eccentric	649, 659, 660, 662, 663	Hammer union elbows	171	Threaded unions	922
Tees		Male fittings	166	Water regulators	289, 326
Clamp	654-657	One-piece flange adapters	170, 171	Break-away coupling	
Instrument	657	One-piece hammer union nuts	167	Industrial	106, 143
Short outlet	656	O-rings	166, 169, 170	Marine	105
Short outlet reducing	657	Plugs	169	Breakaway coupling	
Weld	653-657	Suction service fittings	166	Bevel seat	721
Instrument	657	Three-piece hammer union nuts	167	Clamp	721
Short outlet	655	Two-piece hammer union nuts	167	Breather vents	271
Short outlet reducing	656	Vent-Lock® cam & groove	29, 30, 31, 176, 177, 178	Bulkhead fittings	548, 549, 943
Blow guns		Brass			
Air Chief	277, 1087	Adapters	450, 452		
Extended nozzle	278	Ball valves	878, 879		
Extensions	279, 280	Barbed hose fittings	221, 222, 426-432, 438-444, 1006, 1085		
High volume	280, 281	Boss			
Industrial	283	Clamps	161, 162, 1098		
Non-safety	278, 279	Male stems	159		
Pistol grip	278	Combination nipples	358, 359		
Premium	277				
Safety	277, 280, 1087				
Safety air booster	277, 1087				
Tips	278, 279, 1087				
Typhoon	281				

## Description Index

	Page #	<i>Cam &amp; groove (cont.)</i>	Page #	<i>Cam &amp; groove (cont.)</i>	Page #
Bull plugs .....	946	15° type F adapter x male NPT ...	60	Velcro straps .....	73
Butterfly valves .....	174, 1052	45° adapter x coupler .....	58	Vent-Lock® 29, 30, 31, 176, 177, 178	
B5116-series .....	742	45° coupler x coupler .....	58	Weld fittings	
Clamp .....	741	90° adapter x coupler .....	58	Butt .....	62, 63
Clamp end .....	738, 739, 740	90° coupler x coupler .....	58	Socket .....	62, 63
Socket weld flange .....	952	90° type A adapter x female NPT	58	Witches hat strainers .....	72
<b>C</b>		90° type B coupler x male NPT ...	59	Caps .....	649
Cable junction box .....	150	90° type C coupler x hose shank	59	Acrylic sight glass .....	723
Cables		90° type D coupler x female NPT	59	ADS outalarm .....	150
King .....	261, 263, 1099	90° type E adapter x hose shank	60	ANSI with tapped outlet .....	966
Spillguard™ armored .....	149	90° type F adapter x male NPT ...	60	API, dust .....	1029
Cam & groove		EZ Boss-Lock .....	24, 29, 30, 31, 34, 37, 38, 39, 42, 49, 52, 54, 56, 61, 62, 63, 67, 176, 177, 178	Bevel seat .....	636
150# flange .....	61	EZLink® armless .....	27, 28	Blank end .....	966
Abrasion resistant inserts 32, 35, 73		Flanged .....	61, 82	Boss® wing nut .....	156
Actuator style .....	95	ANSI .....	61, 83	Dust .....	97, 100, 104, 1040
Adapters .....	7, 8, 29, 30, 32, 43, 44, 45, 46, 51, 55, 56, 57, 61, 63, 75, 79, 81, 82, 85, 86, 118, 119, 120, 126, 175, 176, 177, 1022, 1024, 1031, 1032, 1033	Flanged couplers and adapters 118, 119, 124, 1031, 1032		European fittings .....	646, 647, 648
150# ANSI flange .....	61	Gaskets .68, 69, 70, 71, 72, 122, 127, 1025, 1030		Fill pipe .....	1036
Adapter x 150# flange .....	61	Global .....	7, 75-84	Fire .....	816, 817, 818, 819, 820, 827, 834
Adapter x female NPSM .....	64	Handles		Flat face .....	540
ANSI .....	61, 83	Boss-Lock .....	66	Gravity drop adapters .....	1030
Boss-Lock .34, 36, 37, 41, 48, 54, 55, 64, 65, 66, 73, 74		Dixon® .....	66	Hammer union .....	169
Boss® LPS .....	164-171	EZ Boss-Lock handles .....	67	Blanking caps .....	169
BSP thread .....	84	Global .....	83	I-Line / Q-Line .....	641
Adapter x female .....	84	Paddle .....	67	Instrumentation .....	977
Adapter x male .....	84	Vent-Lock® .....	31, 178	John Perry .....	645
Coupler x female .....	84	In-Line sight glasses .....	65	Lok-on .....	445
Coupler x male .....	84	Jump size .....	53, 54, 56, 57, 81, 82	LP gas .....	973
Caps		King Crimp® system .....	26	N-series .....	192
Lockable .....	48	Working pressures .....	26	Nylon .....	942
Clips and lanyards .....	186, 1095	Locking caps .....	48	Pipe .....	937, 942, 1038
Couplers .....		Notched fittings .....	36, 37, 39, 44, 45	Pipe size .....	665
6, 7, 25, 26, 27, 29, 30, 33-42, 52, 55, 56, 57, 61, 64, 65, 76, 77, 78, 81, 82, 83, 85, 86, 87, 93, 119, 120, 121, 176, 177, 178, 1032, 1033, 1034		NST .....	85	Solid end .....	607, 641, 645, 649, 665
150# flange .....	61	Female .....	85	Tank transport .....	1037, 1038
Coupler x 150# flange .....	61	Male .....	85	Thermometer .....	607
Coupler x adapter wye .....	64	Phono finish .....	38, 43	Vacuum relief .....	1035
Coupler x tube with 45° cut .....	65	Pull ring .....	72	Vapor .....	1035
Coupler x adapter .....	53, 54	Rail car unloading assemblies ...	126	Vent .....	1036
with port .....	53, 54	Reducing jump size		Weld .....	621, 649
Crimped fittings .....	7-9, 13-17	Adapter x female NPT .....	56	Carded FRLs .....	317, 1084
Crimp sleeves .....	15-17	Adapter x hose shank .....	57	Check valves	
Disk strainers .....	72	Adapter x male NPT .....	57	800 PSI stainless steel .....	913
Dry disconnect .....	93, 94	Coupler x female NPT .....	57	B45 air blow .....	745
Dust caps ..28, 30, 47, 48, 49, 80, 89, 177		Coupler x hose shank .....	56	Ball cone .....	912
Locking handles for Dixon® cam & groove dust caps .....	66	Coupler x male NPT .....	56	HAV-series .....	746
Dust plugs .....	30, 50, 80, 89, 177	Spool adapters .....	55, 81	EHSC-series .....	743
Elbows .....		Swaged .....	39, 44	HYC-series .....	744
		Swivel couplings .....	25	In-line .....	254, 255
		Tank car fittings ..124, 125, 126, 127		Spring loaded .....	913, 914
		TTMA slip on x socket flange ...	118, 1031	Swing .....	914
		Vapor recovery couplers ...	120, 121, 1033, 1034	Uni-directional .....	255

	Page #		Page #		Page #
<i>Clamp fit. (cont.)</i>		<i>Clamp (cont.)</i>		Connectors, push-in	230, 231, 232, 233, 244, 245, 246, 247, 250, 252
Spring loaded nut	598	With saddles	477	Constant torque clamps	463
Stainless steel hex nut	599	Flexible hose driver	473	Contractor pressure gauges	349
Adapters, clamp by		HTM hi torque	463	Couplers	121
150# flange	613	Hydraulic	568	API	139
Bevel seat	608	Kits	465	Bayonet style dry disconnect	96, 97, 1039, 1040
Brewery hose barb	609	Painted iron	962	Cam & groove	24, 25, 26, 27, 29, 33-42, 52, 55, 56, 57, 76, 82, 176, 177
Female NPT	611	Gaskets	962	Abrasion resistant inserts	35
Hose, rubber	609	Pinch-on	475, 476	Cam & groove actuator style	95
Male NPT	610	Pipe and tube	569, 570	Dry disconnect	93
Tygon® hose	608	Racks	464	MannTek	99, 101, 102, 103
Clamps		Roll over type	471	Garden hose	415
Bolted	597, 664	Safety caps	474	Legris	220
Dairy	598	Service kit	476, 1087	Parker E-z-mate	219
Double pin	597	Single bolt	478	Tank truck	119, 1023, 1032
I-line / Q-line	637	Smooth ID	471	Female coupler	1021
Pipe size	664	Spiral	479	NPT	1021
Single pin	596, 664	Stepless ear	476	Vapor recovery	120, 121, 1033, 1034
Single pin w/ serrated nut	596	T-bolt	466, 467, 468	Locking handle	121
Squeeze	596	Tools	473, 474, 476	with grounding tab	1030
T-bolt	598	Wave seal	462	Coupling	
Three segment	597	Worm gear		Ground joint	153
Toggle	597	Aero-Seal®	461, 462	Inserter	1059
Clever clamp	595	Constant torque	463	Lubricant	1063
Crosses	612	Dixon®	460	Couplings	
Elbow		HTM hi torque	463	Agri-Lock style	378, 379, 380, 381
45°	602	Make-a-clamp kits	465	Air King® universal	180, 181, 182, 183, 184, 1096
90°	602	Marine grade	461	A-series	212, 213
180° returns	612	Miniature	460	Bauer style	382, 383, 384, 385, 387, 388
Bevel seat	602	Quick release	465	Bayonet style dry disconnect	96, 97, 1039, 1040
Plain	602	Racks	464	BR-series	211
Ferrules		Claw type fittings	180, 181, 182, 183, 184, 1096	Cam & groove	6, 7, 24, 27, 28, 29, 30, 33-42, 52, 53, 55, 76, 77, 78, 81, 82, 83, 93, 95, 119, 120, 121, 176, 177, 1032, 1033, 1034
Automatic weld	601	Clever Clamp	595	CJ-series	206
Heavy wall tank	601	Close nipples	927, 928	DF-series	197, 198, 199, 200, 201, 1086
Light wall tank	601	Combination nipples	9, 10, 11, 173, 358, 359, 360, 361, 363	Dix-Lock® quick acting	190, 191, 192, 193, 1098
Long weld	600	Bauer style	383	Dry evotek	108
Reducing	600	Global	360	Dry quick disconnects	93-103, 105, 106, 143, 1039, 1040
Reducing roll-on for expanding	600	Jump size	360	DF-series	198-201
Roll-on for expanding	601	Sleeves	364	Dual Lock quick-acting	194-196
Short weld	600	Combination units		Equipment	572, 586
Gaskets	673-681	Series 1	319, 332	Global Air King® quick-acting	183
Laterals	612	Watts	343	Global Air King® universal	182, 183
Reducers		Wilkerson	291, 306-310	Ground joint	153, 163, 1097
Clamp x plain bevel seat	605	Composite mini ball valves	253	Ground joint air hammer	163
Concentric	605	Compound gauges	350	Hex	421, 449, 552, 922
Eccentric	606	Compression fittings	978, 979, 980, 981, 982, 983	High density polyethylene	969
Tees		Connectors	978, 979	Holedall®	577, 582, 584
Equal	604	Elbows	980, 981	API certified	579, 584
Reducing	604	Inserts	982	Dubl-Grip re-attachable	587
Short outlet	604	Nuts	983		
True wye	612	Plug	982		
Clamps	137, 567, 568, 569, 570	Reducers	979		
Accessories	472, 473	Sleeves	982, 983		
Aero-Seal®	461, 462	Tank fittings	980		
Air King®	185, 1096	Tees	981, 982		
Band	469, 470	Compressor Y valve	267		
Band & buckles system	472, 474	Concentric reducers	605, 635, 661, 662		
Bolted	466, 467, 468, 477, 478, 567	Conical mufflers/filters	271		
Boss®	161, 162, 1097	Connectors			
Center punch	469, 471	Instrumentation	974		
Constant torque	463				
Counterbalance	137				
Double bolt	477, 567				



Elbows (cont.)	Page #	External crimp ferrules	Page #	Filter/Regulators (cont.)	Page #
Instrumentation .....	975, 976	External drain cocks .....	274, 908	Mini's .....	289, 290
LIQUIfit™ .....	992, 993, 994, 995	Externally swaged fittings .....	363, 574, 575, 576, 577, 579	Series 1 .....	326, 327
Nylon .....	1006, 1009	External swage ferrules ...	363, 578, 579	Watts .....	340, 341
Polypropylene .....	1006	EZ Boss-Lock .....	6, 24, 29, 30, 31, 34, 37, 38, 39, 42, 49, 52, 54, 56, 61, 62, 63, 67, 121, 125, 176, 177, 178	Wilkerson .....	289, 290, 302, 303
Push-in 228, 231, 232, 241, 242, 245, 247, 249, 251, 252, 256, 258		External crimp ferrules .....	13, 14	Filters .....	292-296, 319-322
Side seal fuel delivery .....	1021	External drain cocks .....	274, 908	Accessories 312, 313, 314, 315, 316, 333, 334, 344	
Splicer .....	430	Externally swaged fittings .....	363, 574, 575, 576, 577, 579	Airline .....	292, 293, 319, 320, 321
Street .....	453, 931, 932	External swage ferrules ...	363, 578, 579	Carded .....	317, 1084
Sweep .....	603, 617	EZ Boss-Lock .....	6, 24, 29, 30, 31, 34, 37, 38, 39, 42, 49, 52, 54, 56, 61, 62, 63, 67, 121, 125, 176, 177, 178	Disposable in-line nipple .....	269
90° Weld .....	617	EZLink® armless		Hydraulic	
Threaded		Bottle opener .....	28	In-line .....	568
45° .....	431, 453, 933	Couplers .....	27	In-line, air/oil .....	268
90° .....	429, 439, 452, 453, 930, 9031, 932, 941	Dust caps .....	28	Lubricator .....	269
reducing .....	931	Replacement gaskets .....	28	Mini in-line .....	269, 272
side outlet .....	935	Replacement kits .....	28	Oil removal .....	321
Tectite™ .....	991	Safety clip .....	28	Sanitary .....	727, 728, 729, 730, 731
Tuff-Lite .....	1006, 1009			Series 1 .....	317, 318, 319, 320, 321, 322, 326, 327, 1084
<b>Engineered fluid transfer</b>		<b>F</b>		Watts .....	339
ADS .....	144-149	Faucets .....	915	F602 .....	339
Accessories .....	150	Compression bibb .....	915	Wilkerson ..	288, 289, 290, 292-296, 302, 303
Outalarms		Ferrule crimping tools .....	434-437	<b>Finger type clamps</b> .....	161, 162, 1097
Cable junction boxes .....	150	Ferrules		<b>Fire fittings, hose &amp; accessories</b>	
Caps .....	150	Air King® .....	184	Adapters .....	88
Gauge rods .....	149	API certified .....	585	Double male	
Open dome adapters .....	150	Automatic weld .....	601	Pin lug .....	813
Outage gauge .....	149	Auto weld .....	651	Rocker lug .....	813
with capacitance probe .....	145	Brass .....	433, 446, 447, 448	Rocker lug, style N36 .....	814
Spillguard™ monitors .....	146	Dies .....	434, 436, 437	Hazmat	
Armored cables .....	149	Crimped, sanitary .....	593	Pin lug .....	802
Probes .....	147	External swage 44, 45, 362, 363 578, 579		Hex	
<b>Equipment</b>		Global Air King® .....	185	Double female .....	795
Clamp tools .....	474, 476	I-Line/Q-Line .....	638, 639, 640	Double male .....	813
Coupling inserter .....	1059	Instrumentation .....	977	Double male, NYFD threads .....	812
Crimpers .....	435, 436, 437	Internally expanded .....	581	Hydrant	
Cutters .....	1003	John Perry .....	644	Cam & groove .....	64, 814
for push-on fittings .....	445	King Crimp® .....	13, 14	Pin lug .....	412, 800, 802, 1079
Hand hydrotest pump .....	1060	Heavy duty .....	12, 173	Rocker lug .....	803
Hydrostatic test pumps .....	1060	Short frac .....	11, 166	Long handle	
Test pumps .....	1060	Long weld .....	600, 665	Style N37 .....	799
<b>European Fittings</b>		Notched .....	44, 45, 362, 363	Style N54L .....	810
DIN		Oxy-acetylene .....	458	Style N56 .....	801
Blank cap .....	646	Petroleum .....	585	Open snoot .....	796
Round nut .....	646	Pipe size .....	664, 665	Pin lug	
Spanner wrench .....	647	Reducing .....	600	Cam & groove .....	64, 814
Welding liner .....	646	Reducing roll-on .....	600	NY threads .....	802
Welding male .....	646	Roll-on .....	601	Swivel .....	796
Gaskets .....	688, 689	Sanitary (IX) style .....	590	Rocker lug .....	795, 796, 797, 798, 799, 801, 806, 807, 809, 810, 814
RJT		Holedall Petroleum style .....	583	Storz .....	823
Adapters .....	648	Short weld .....	600, 664	Style N35 .....	799
Blank cap .....	648	Tank .....	601	Style N36 .....	814
Hex nut .....	648	<b>Fill pipe</b>		Style N57 .....	806, 807
Spanner wrench .....	648	Adapter caps .....	1036	Style N53 .....	798
Welding liner .....	648	Adapters .....	1028	Style N54 .....	810
SMS		Filter/regulators .....	302, 303, 326-328	Swivel .....	796
Adapters .....	647	Accessories .....	333-338, 343, 344	Single male outlet .....	804
Blank cap .....	647	Carded .....	317, 1084	Storz	
Round nut .....	647				
Spanner wrench .....	647				
Welding liner .....	647				
<b>Exhaust muffler</b>					
Wilkerson .....	310				

## Description Index

Fire fittings (cont.)	Page #	Fire fittings (cont.)	Page #	Fire fittings (cont.)	Page #
FSA .....	822	Forestry .....	769	Blue devil select gallonage ...	793
Hydrant .....	826	Elbows		Break apart attack .....	789
MSA .....	824	Angle and suction .....	832	Dual range .....	793
Rigid female .....	822	Continuous swivel .....	832	Fog .....	412, 781
SFSA .....	823	Storz		Constant flow .....	787, 788
SSA .....	826	30° elbow .....	826	Econo .....	788
SSA30 .....	826	Long handle, SFSA30 .....	825	Electrical fire .....	780, 786
Suction		Rocker lug, SFSA30 .....	825	Flow rate chart .....	781
Female, rocker lug .....	795	Expansion ring & gasket guide ..	768	FM approved .....	786
Male, rocker lug .....	809	Fire jacket		Forestry .....	791
Swivels		For hose .....	778, 1068	Forestry, global .....	790
Female to male, long handle ...		Tape .....	778, 1068	Gaskets .....	786, 787
.....	810	Non adhesive .....	778, 1068	Industrial .....	780
Female to male, pin lug .....	808	Flange		Industrial, heavy duty .....	780
Female to male, rocker lug .....	808,	Storz		Industrial, high pressure .....	780
.....	810	NCS-CSF .....	825	Refinery, blue .....	787
Male, pin lug .....	808	Forestry		Tri-Flo .....	788
Axe .....	851	Expansion ring couplings .....	769	U.S. Coast Guard approved .....	784
Backflow preventer .....	870	Hose clamp and spanner .....	830	Forestry	
British instantaneous fittings ...	849,	Nozzles .....	790, 791	Twin tip, straight stream ...	792
.....	850	Valves .....	861	Gallonage	
Cam & groove x NST .....	815	Wrench .....	830	Adjustable Tri-Flo .....	790
Type A .....	815	Hose		Constant .....	794
Type B .....	815	300# single jacket .....	751	Dual .....	790
Type D .....	815	500# rack		Select .....	793, 794
Caps		Non UL labeled .....	755	Single .....	790
Breakable .....	819	UL labeled .....	754	Garden hose .....	788
Aluminum .....	819	500# single jacket .....	752, 753	Master stream .....	785
Polycarbonate .....	819	Color impregnated .....	753	Monitor .....	785
Hydrant .....	818	UL labeled .....	752	Penetrator .....	792
Pin lug .....	816	800# double jacket .....	753	Pistol grip adapters .....	789
Rocker lug .....	816, 817	Color impregnated .....	753	Plain hose .....	782, 783
Test .....	816, 817	Cabinet .....	777	Rack	
With cable .....	817	Double jacket, potable water ..	754	Global .....	781
Specialty .....	819	Forestry		Shut-off	
Cap test gauges .....	820	Forestry mop up .....	756	Ball .....	782, 789
Domestic, pin lug .....	819	Forestry mop up, hose kit ..	756	Ball, forestry grade .....	791
Hydrant .....	819	Non weeping .....	756	Ball, pistol grips .....	791, 792
Plugs with cable, rocker lug ...		Nitrile covered		Ball, tips .....	791
.....	820	500# .....	755	Ball, with nozzle .....	792
Storz .....	827	Heavy duty .....	757	Dual gallonage .....	790
Test .....	816, 817	Non-collapsible		Single gallonage .....	790
Universal hose .....	818	Chemical booster .....	758	Street cleaning .....	783
With cable .....	817	Fire and utility .....	758	Tips .....	782
Long handle .....	817	Single jacket mine, MSHA		Twist .....	782
With chain .....	818	approved .....	754	U.S. Coast Guard Approved AFFF	
Pressurizable cap .....	818	Hydrant		.....	784
Connections		Adapters .....	88	Viper™ .....	793, 794
International shore .....	850	Hydrant body, 2-way .....	843	Washdown	
Residential sprinkler .....	847	Identification plates		Street cleaning .....	783
Roof .....	835, 836, 837	Round .....	848	Water fog .....	784
Siamese		Manifolds .....	833	Play pipes .....	783
Double clapper .....	839	Monitor		Tips .....	783
Single clapper .....	838	FirePro™ .....	785	Plugs	
Trippler clapper .....	840	Nozzle .....	785	Adjust-A-Plug .....	820
Single hydrant .....	847	Omega™ .....	785	FDC .....	820
Single inlet .....	847	Nipples		Pin lug .....	821
Sleeve for sidewalk .....	837	Hex, double male .....	811	Domestic .....	821
Couplings		Hex, female to male .....	803, 804,	Rocker lug .....	821
Booster, hose type .....	769	.....	805	Pressure restricting device .....	868
Expansion ring .....	766, 767, 769	Hex, female to male, NY threads		Pump test headers .....	833
Forestry, forged .....	769	.....	805	Racks	
Gaskets		Nozzles			



Fire fittings (cont.)	Page #	Fire fittings (cont.)	Page #	Flanged (cont.)	Page #
Hose .....	775	Angle .....	865, 869	ANSI .....	83
Hump .....	775	500# .....	853	Combination nipple .....	10, 361
Covers .....	775	Cast .....	852, 854	Dry aviation .....	104
Pin .....		Forged .....	855	Dry disconnect .....	94
Covers .....	776	Ball .....	863	Dry quick disconnect .....	99, 100
Hose assembly .....	776	Chicago pattern .....	870	External swage fixed .....	576
Nipples .....	776	Drain .....	871	External swage floating .....	576
Semi-automatic .....	776	Drip, ball .....	864	Quick-connect, fittings .....	378, 379, 383, 384
Wall bracket .....	776	Gate .....		Safety break-away .....	105, 106, 143
Reels .....	771	Hydrant .....	859	Swivels .....	132, 136
Continuous flow .....	773	Hydrant, global .....	859	Tank truck ..	118, 119, 121, 122, 123, 1025, 1026, 1031, 1032
Accessories .....	773	Hydrant, single .....	858, 859	Weld fittings .....	118
Covers .....	773	Large diameter .....	860	Tee .....	1031
Global continuous flow .....	772	Wedge disc .....	856, 857	TTMA extensions .....	119, 134
Cover .....	772	Globe .....	864, 866	Weld adapters .....	171
Replacement inlet swivel joint .....	772	Pressure reducing .....	867, 868	Flanges .....	624, 704, 956
Style V swing type .....	770	Relief .....	872	150 Lb. ....	956, 957
Covers .....	770	Sprinkler hose .....	871	Adapters .....	964
Swing type .....	771	Wye .....	861, 862, 863	ANSI flat face .....	957
Covers .....	771	Wall hydrants .....		ANSI Split .....	964
Heavy duty, high capacity ..	771	Exposed 2-way .....	847	Boss ductile .....	955
Pipe brackets .....	771	Wall plates .....		Floating .....	956
Siamese assemblies .....		For concealed 3-way bodies ..	845	Gaskets .....	122, 957, 1025
Double clapper concealed type ..	846	For double clapper .....	845	Hydraulic .....	
Two way sidewalk .....	846	Washers .....		Pipe socket weld .....	565
Siamese body .....	842	Swivel .....	767	Lap joint .....	955, 956
Snoots .....		Tail .....	767	NPT .....	956
Clapper type, pin lug .....	845	Wharf hydrants .....	861	Slip-on .....	118, 955, 956, 1031
Spring check type, pin lug ..	844	Wrenches .....		Socket weld butterfly valve .....	952
Sprinkler line tester .....	851	Adjustable .....		Stub end .....	955
Storz .....	827, 828, 831	Double head .....	829	TTMA .....	10
Accessories .....	827	Hydrant .....	828, 829	Weld neck .....	957
Adapters .....	823, 826	Pigtail .....	829	Flare fittings .....	984, 985, 986
Caps .....	827	Hydrant .....	830	37° .....	543-549, 555, 556
Elbows .....	825, 826	5 hole .....	829	Connectors .....	984
Flanges .....	825	Adjustable .....	828, 829	Elbows .....	545, 546, 547, 985, 986
Gaskets .....	827	Double head adjustable .....	829	Nuts .....	548, 549, 986
Hydrant wrench .....	828	Pigtail adjustable .....	829	Tees .....	986
Locking device .....	827	Storz .....	828	Unions .....	985
Mounting plates (bracket) ..	827	Spanner .....	828, 830, 831	Flareless bite fittings .....	557, 558, 559, 987, 988, 989
Rigid female .....	822	Folding pocket .....	828	Adapters .....	557, 558, 987, 988
Rigid male .....	824	Forestry .....	830	Elbows .....	558, 559, 988, 989
Valves .....	872	Grip-All .....	829	Ferrules .....	559, 989
Wrenches .....	831	Hole type .....	828	JIC .....	557, 987
Suction .....		Long handle suction .....	830	37° .....	557
Elbows .....	832	Storz, pin lug .....	831	Nuts .....	559, 989
Short shank, long handle .....	832	Universal .....	828	Tees .....	559, 989
Swivels .....		Storz .....	828, 831	Unions .....	558, 988
Adapter .....		Universal .....	828	Flat face fittings .....	539, 540
Female to male, pin lug .....	808	Fire hose .....		FloMax connectors .....	
Double female .....	797	Axe .....	1066	3/4" series .....	117
Pin lug .....	797	Nozzles .....	779-794	Diesel fueling system ..	109, 110, 111
Rocker lug .....	797	Spanner wrenches .....	372, 828-831	Fuel vent .....	109, 110, 111, 112
Elbows .....	832	Flame retardant hose protection ..	1067	Gravity fill receiver .....	112
Replacement and accessories ..	821	Flange .....		High flow 1" series .....	117
Storz .....		Code 61 / Code 62 hydraulic ..		R series .....	109, 115, 116
Style N35, rocker lug .....	799	Split flange kit .....	566	Service box .....	112
Style N53, rocker lug .....	798	Flanged .....		Standard .....	109, 113, 114
Style N57, long handle .....	799	Adapters .....	170, 171, 964	Flow control .....	
Valves .....		45° elbow .....	170	Series F valves .....	276, 560, 904
		Short .....	170		
		Straight .....	170		
		Cam & groove .....	61, 82		

## Description Index

Flow Control (cont.)	Page #	Garden Hose (cont.)	Page #	Gaskets (cont.)	Page #
Series MV metering valves	560, 904	Gooseneck	417	Pipe	671, 672
Series N valves	276, 560, 905	Hex nut with knurl	422	Q-Line	
Flow control valves		Hot water rubber reinforced	411	nitrile rubber	685
Legris	253, 254	Lok-on hose fittings	441	Railroad tank car	127
Food grade anti-seize	1058	Caps	445	Sand blast	187
Foot valves	391	Manifold	417	Shank couplings	377
Assemblies	391	Marine, camper, patio & pool	411	Tank truck	
Seat plates	391	Menders	369, 418, 419, 1010, 1078	Transport	1037
Frac fittings	165, 166	Plugs	415	TTMA	122, 1025
Caps	169	Premium rubber	410	Technical Information	
Complete assembly	165	Quick connectors	415, 1078	Identification	673
Female	165	Radiator bibb	417	Packing and storing	673
Ferrules	166	Round nut with knurl	422	Sizing guide	691–692, 1142–1143
Flange adapters		Rubber vinyl	410, 1081	Gauges	1062
45° elbow	170	Shank fittings	419, 420, 421, 422, 1078	Compound	350
Short	170	Spray hose fittings	419	Contractor pressure	349
Straight	170	Top level PVC	411	Digital	354
Male	166	Tuff-Lite®	1008, 1009	Dry	
O-rings	166	Valves	416, 417	ABS standard	345, 1088
Plugs	169	Washers	412, 1011, 1079	Brass standard	347
Union nuts		Zinc fittings	418	Flutter Guard™	348
One-piece	167			Stainless steel	346
FRLs (Filters, Regulators, Lubricators)		Gas		Line test	1062
Accessories	312, 313, 314, 315, 333–338, 343, 344	Dry couplings	102	Liquid filled	
Carded	317, 1084	Natural gas	107	ABS case	351
Combination units	291, 306, 307, 308, 309, 319, 332	Regulators	325	Brass	353
Filter/regulator	2, 289, 290, 317, 318, 326, 327, 328, 1084	Gaskets	943, 957, 967	Stainless steel	351, 352
Filters	265, 317, 318, 319, 320, 321, 322, 327, 328, 332, 334, 1084	Agri-Lock style	381	Panel builder	349
Lubricators	317, 318, 319, 328, 329, 330, 331, 332, 333, 336, 1084	Bauer style	386	PITOT	1062
Regulators	2, 317, 318, 319, 323, 324, 325, 326, 327, 328, 332, 1084	Bevel Seat		Pressure gauges	
Series 1	2, 272, 317–338, 1084	nitrile rubber, flat style	682	Homogenizer	709
Metal bowl and sight glass	319, 320, 321, 326, 327, 332	nitrile rubber	682	Pharmaceutical	708
Transparent bowl	319, 320, 326, 327, 332	EPDM	682	Sanitary	705–708
Watts	339, 340, 341, 342, 343, 344	FKM	682	Pressure transmitters	711
Wilkerson	288–316	PTFE	683	Process	347
Fuel delivery		Silicone - white	683	RTDs (temperature)	711
Elbow inlets	1021	Cam & groove	28, 68, 69, 70, 71, 72, 1030	Sprinkler system	1062
Side seal elbows	1021	Clamp		Steam siphons	354
Straight drop	1021	nitrile rubber - black	674	Three way	1062
Fuel nozzles	110, 111	nitrile rubber - white	674	Tire inflator chuck	284, 1085
Fuel receivers	110, 111	EPDM	674	Tire pressure	
		FKM	675	Dual foot	284, 1085
		Flanged	677	Heavy duty	284, 1085
		Metal and x-ray detectable	676	Passenger car	284
		orifice	680	Professional	284, 1085
		PTFE	675	Vacuum	350
		silicone - clear	675	Welding	353
		silicone - white	675	Gravity drop adapters	1029
		European		Dust caps	1030
		DIN nitrile rubber	688, 689	Grease whip	456, 457
		RJT nitrile rubber	688, 689	Hose assemblies	456
		SMS nitrile rubber	688, 689	Hose fittings	456
		Flange	624, 629	Zerk	457
		Foot valve	391	Retail packaged	457
		Holedall®	586	Grip-L couplings	953
		I-Line		Grooved fittings	962, 965
		nitrile rubber	684	Accessories	968
		EPDM	684	Clamps	962
		FKM	684	End caps	966
		John Perry		Gaskets	967
		EPDM	686	Lightweight	960
		FKM	687	Mechanical tees	963
Garden hose					
Adapters	423, 424				
Backflow preventer	417				
Compression bibb faucets	415				
Coupler	415, 416, 422, 1080				
Flexogen®	410				

## G

Grooved Fittings (cont.)	Page #	Holedall (cont.)	Page #	Hose assemblies	Page #
Quick release .....	958	Swaging machines .....	572	GSM ball-joint armored ..	1018, 1070
Rigid .....	961	Washers .....	586	Whip .....	1101
Series 45 .....	965	Hookie - hook hose lifter .....	949	Hose assembly tool .....	445
Series 90 .....	965	Hose		Hose lifter .....	949
Series AN .....	966	Air .....	282, 1088	Hydraulic	
Series BE .....	966	Air, self-storing .....	282, 283, 1088	AG-series 492, 493, 510, 1091, 1092,	1093
Series EC .....	966	Coil-chief .....	282, 1088	BSPP fittings .....	556
Series FA .....	964	Assembly kits .....	282	Clamps .....	568
Series RA .....	964	Bulk hose .....	282	CM-series .....	535, 536, 537, 538
Series SF .....	964	Braided rubber .....	409	Code 61 / 62 flanges ..	564, 565, 566
Series T .....	963, 965	Bumper stops .....	287	Couplings .....	399, 400, 401
Standard .....	959	Crimper .....	436, 437	CVV-series .....	529, 530
Grooved nipples .....	966	Cutters .....	1003	EA-series .....	534
Grooved stem style ext. crimp ferrule ...	13-14	Diameter tape .....	1064		
Grooved valves .....	966			Elbows 542, 543, 545, 546, 547, 549,	550, 551, 553, 556
Groove lube .....	968	Fittings, barbed .....	191, 192, 195,	E-series .....	399, 400, 401, 531, 532,
Ground joint		198, 200, 201, 202, 203, 204, 205,		533, 1073	
Fittings .....	163	208, 209, 210, 211, 212, 213, 216,		Filter .....	568
GSM Ball-joint armored .....	1018, 1070	217, 218, 219, 221, 222, 223, 224,		Flat face fittings .....	539, 540
		227, 368, 426, 427, 428, 429, 430,		H-BOP-series .....	488
		431, 432, 438, 439, 440, 441, 442,		H-series .....	481-487
		443, 444, 1005, 1006, 1009, 1085		HS-series .....	489
		Flexogen® .....	410	HTE-series .....	509
		Garden .....	410, 411, 1081	HT-series ...	504, 505, 506, 507, 508,
		GSM Ball-Joint Armored	1018, 1070	1091	
		Hot water reinforced .....	411	HTZ-series .....	510
		Hot water washdown .....	411	JIC fittings ..	541, 543, 544, 545, 546,
		Knife .....	1064	547, 548, 549, 550, 555, 556, 557,	566, 950
		Mallet .....	1064	K-series .....	490, 491
		Menders .....	160, 367, 368, 369, 419,	Metric fittings .....	555
		428, 440, 1007, 1010, 1078		NPTF fittings .....	551, 552, 553, 554,
		Mill .....	759, 760, 761, 762	555, 556, 557	
		Synthetic double jacket .....	762	PD-series .....	515
		Synthetic single jacket	759, 760,	Return line .....	567
		761		ST-series .....	512, 513, 514
		Nitrile .....	763, 764, 765	TD-series .....	530
		Nominal smooth bore .....	1013	TR-series .....	503
		Pressure washer .....	409	T-series .....	527, 528
		Protection		Valves	
		Sleeves, sleeving .....	1069	High pressure ball .....	561, 897
		Spiral .....	1067	VEP-BOP series .....	519
		Spring guard .....	1018, 1070	VEP-series .....	516, 517, 518, 519
		Reels .....	286, 287, 409	V-series .....	494-502
		Adjustable bumper stops .....	287	Weld end metal hose fittings ..	550,
		Room equipment .....	1064	950	
		Spiral		WS-BOP series .....	526
		Flame retardant .....	1067	W-series .....	520, 521, 522
		Standard .....	1067	WS-series .....	523, 524, 525
		Splicer .....	447	XK-series .....	511
		Spray couplings .....	376, 377, 419		
		Spring .....	238		
		Spud .....	160		
		Swivels ...	184, 227, 285, 1044, 1045		
		Heavy duty .....	1044		
		Hose shank .....	1044		
		MannTek .....	1044		
		Single plane .....	1045		
		True ID, open pitch .....	1016		
		True ID, smooth bore .....	1016		
		Washdown .	410, 411, 763, 764, 765,		
			1081, 411		
		Whip .....	1101		

	Page #		Page #		Page #
<b>I</b>					
I-Line fittings		J		L	
Adapters		Jax food grade penetrating oil .....	1057	Lanyards .....	74, 186, 1095
Female .....	642	JIC fittings 432, 442, 443, 544, 545, 546,		Leak detector .....	1056
Male .....	642	547, 548, 549, 555, 556, 557, 566		Legris fittings ... 244, 245, 246, 247, 248,	
Caps, solid end		John Perry fittings		249, 250, 251, 252, 253, 254, 255, 256,	
Female .....	641	End caps .....	645	257, 258	
Male .....	641	Ferrules		Lever external drains .....	274, 908
Clamps		Plain long .....	644	Lincoln interchange .....	208, 214, 225
Bolted .....	637	Plain short .....	644	Line strainers .....	970
Heavy duty .....	637	Threaded long .....	644	LIQUIfit™ fittings .....	992, 993, 994, 995
Single pin .....	637	Threaded short .....	644	Adapters .....	994
Squeeze .....	637	Gaskets .....	686, 687	Connectors .....	992, 993
Elbows		Hex Nuts .....	643	Elbows .....	992, 993, 994, 995
Female		Wrenches .....	643	End stops .....	994
90° .....	640	Single side .....	643	Plugs .....	994
Female x male		Two sided .....	643	Reducers .....	995
90° .....	640	<b>K</b>			
Male		King .....	172, 173	Stems .....	995
90° .....	640	Cables .....	261, 263, 1099	Tees .....	993, 994, 995
Ferrules		Straps .....	262	Unions .....	993
Female		Cam & groove .....	7	Lockable caps .....	48
Heavy wall tank .....	639	Adapters .....	8	Locking ball valves .....	876, 883
Long weld .....	639	Couplers .....	6, 7, 27	Locking kit, dry disconnect .....	93
Short weld .....	639	Combination nipples ... 9, 10, 11, 12,		Lok-on fittings .....	441
Male		173, 358, 359, 360, 361, 363		Caps .....	445
Heavy wall tank .....	638	Global .....	360	Long shank couplings .....	372, 374, 375,
Long weld .....	638	Jump size .....	360	422	
Short weld .....	638	Sleeves .....	364	LP	
Gaskets .....	684, 685	Crimp style		Boss® male stems .....	160, 568
Industrial		150# ASA fixed (welded) flange .		Gas couplings & adapters .. 971, 972	
Blow gun .....	283	10		Caps .....	973
Internally expanded fittings .....	581	Adapters .....	8	Dust plugs .....	973
Quick connects ... 214, 215, 216, 217,		Combination nipples ... 9, 11, 173		Gaskets .....	972
218, 219, 220		EZLink® armless .....	27	Wrench .....	972
Safety break-away .....	106, 143	Ferrules .....	13, 14	Lubricants	
In-line .....	254	Global cam & groove .....	7	Air tool .....	267, 1089, 1100
Check valves .....	255	Nipples for floating flanges ... 10		Anti-freeze .....	267, 1100
Desiccant dryers .....	273, 297	Sanitary .....	11, 591	Food grade anti-seize .....	1058
Filter		Short frac ferrules .....	11, 166	Groove lube .....	968
Air .....	268, 269, 272	Sleeves .....	15, 16, 172, 364	Jax food grade penetrating oil . 1057	
Mini .....	272	TTMA flange x King Crimp® ... 10		PurGel Klear .....	1058
Filters		Ferrules .....	13, 14	Stainless steel cleaner and polish ...	1058
Disposable .....	269	Frac .....	166	Lubricators	
Flow control .....	253, 254	Heavy duty .....	12, 173	Accessories .....	336, 337, 338, 344
Lubricators .....	268, 269, 1100	Flanged .....	10, 361	Carded .....	317, 1084
Swivels .....	285	Nipples for floating flange .....	10	EconOmist®	
In-line sight glass .....	65	Frac .....	173	Compact .....	303, 304
Inserts		Hose menders .....	368	Standard .....	304, 305, 306
Abrasion resistant .....	73	PF shank .....	363	In-line .....	268, 269, 1100
Instrumentation		Plastic pipe .....	361	Mini .....	290
Digital thermometers .....	710	Shank couplings .....	370, 371, 372	Series 1 .....	317, 318, 328, 329, 330,
Instrumentation fittings ... 974, 975, 976,		Sleeves .....	15, 16	331, 1084	
977		Large .....	172	Oil-fog .....	329, 331
Interlocking clamps .....	161, 162, 185,	Short .....	17	Watts .....	342
1096, 1097		Steel hex nipples .....	365	Wilkerson ... 290, 303, 304, 305, 306	
Intermodal .....	1038	Steel round nipples .....	365		
		Whipsocks .....	263		
		Shackles .....	263		

M	Page #	Nipples (cont.)	Page #	Nozzles (cont.)	Page #
Magnetic thermometers .....	356	Polypropylene .....	940	Pressure .....	402
Make-a-clamp kit .....	465	Nitrile washdown hose ....	763, 764, 765	Pressure with extension ....	402
Mallet, hose .....	1064	Notched		Valves	
Manifolds		Cam & groove fittings ..	36, 37, 44, 45	Balance release .....	408
3 in 1 .....	266, 1087	Ferrules .....	362, 363	Safety release .....	409
Air receiver .....	263, 264, 265	Stems, Holedall® .....	363	Thermal relief .....	409
Aluminum bar .....	266	Turned back nipples .....	362	Unloader .....	409
GHT, 4-valve .....	417	Nozzles		Water broom .....	408
Hex, flat .....	267	Accessories		Sewer .....	405
Modular .....	252	Breakaways .....	1045	Spray .....	395-398
Regulator .....	325	Multi-plane hose swivels ....	1045	Sweeper .....	413, 1078
Marine grade worm gear clamps ....	461	Single plane hose swivels ..	1045	Tank truck ..	1041, 1042, 1043, 1046, 1047, 1048, 1049
Mechanical tees .....	963	Adjust-A-Power .....	414, 1078	Temperature indicating .....	398
Menders ...	160, 367, 368, 369, 418, 419, 428, 440, 1007, 1010, 1078	Automatic shutoff .....	1049	Twist .....	413, 1079
Merchant couplings .....	921	Ball .....	1041	Washdown	
Mini		Big Mouth™ diesel .....	1047	Adjust-A-Power .....	414, 1078
Ball valves .....	253	Constant flow .....	414, 1080	Constant flow .....	414
Carded FRLs .....	317, 1084	Displays .....	414, 1080	Elevated temperature .....	395
Combination units .....	291, 319	Farm and consumer .....	1048	Hot water .....	396, 413
Desiccant dryer .....	273	Fire .....	779-793	Industrial .....	398
Filter/regulators .....	289, 290, 318	FloMax refueling 110, 111, 113-117		Insulated .....	413, 1079
Filters .....	272, 288, 318	Fog .....	412, 779-781	Lite .....	396
Lubricators .....	269, 290, 318	Fuel .....	1041-1043, 1046-1049	Spray .....	397, 398
Regulators ...	272, 288, 289, 318, 325	Cross reference .....	1048	Mini .....	397
Muffler		Fuel Master™ diesel .....	1046	Sweeper .....	413, 1078
Conical .....	271	Gravity .....	1042, 1043	Temperature indicating .....	398
Exhaust .....	310	High flow fueler .....	1049	Twist .....	413, 1079
Speed control .....	271	Holders .....	187	Wand .....	397
Super quiet .....	272	Hot water washdown, spray ....	396	Water .....	413
Mulconroy .....	572	Injector .....	405	Water broom .....	408
		Lite washdown, spray .....	396	Water .....	413, 1079
		Plain hose .....	414, 1080	Hot water .....	413
		Pressure .....	1035, 1043	Insulated .....	413, 1079
		Pressure washing .....	402	Pistol-grip .....	413
		Anti-fatigue		Power flow .....	413
		Heavy duty .....	402	Water, flexible .....	413
		Lances and extensions .....	403	NPT threaded fittings .....	944, 951
		Dual spray lance .....	403	Gaskets .....	944
		Lance belt .....	404	NYFD	
		Molded grip extensions ...	403, 1076	Adapters .....	841
		Spray lance .....	403	Nylon fittings .....	939-942, 994, 1005
		Telescoping lance .....	404	Nylon tubing .....	1001, 1002
		Vented grip lance .....	403		
		Line strainer .....	405		
		Nozzle holders .....	408		
		Nozzles			
		Injector .....	405		
		Quick connect .....	406, 1074		
		Quick connect, multi-pack .....	406, 1074		
		Quick connect, soap .....	406		
		Selection guidelines .....	407		
		Spray chart .....	407		
		Spray, high pressure .....	406, 1075		
		Spray, high pressure soap .....	406		
		Turbo .....	408, 1075		
		Turbo, inlet filter .....	408		
		Quick couplings			
		Fixed plugs .....	405, 1074		
		Swiveling .....	404, 1074		
		Spray guns .....	402		
		Anti-fatigue .....	402, 1075		
		Kit with hose, nozzle & lance ...			

Page #	Plugs (cont.)	Page #	Page #
<b>P</b>			
Panel builder gauges .....	Garden hose .....	415	Protection Covers
Parker Ez-Mate .....	Hammer union .....	169	Clamp .....
Petroleum fittings, API .....	Blanking plugs .....	169	Weld End .....
Phonographic fittings .. 38, 43, 363, 957	Low pressure .....	169	PTFE
Pinch-on clamps	Hex .....	455, 543, 555, 938	Gaskets .....
Double ear .....	Hex head .....	942	Hose .....
Single ear .....	Hydraulic flat face .....	540	Nominal smooth bore .....
Stepless® ear .....	Instrumentation .....	977	True ID .....
Pin lug .....	LIQUIfit™ .....	994	Heavy wall smooth bore ..
Caps .....	LP gas .....	973	Open pitch convoluted ....
Hydrant	Push-in fittings .....	251, 258	PTFE hose fittings .....
Adapters 412, 796, 800, 802, 808,	Quick-connect .... 202, 216, 221, 223,	225	Insertion tool and dies .....
813, 1079	Square head .....	455, 938, 942	Nominal fittings .....
Plugs .....	Plug wrenches .....	915	Nominal smooth bore .....
Spanner wrenches .....	Pneumatic		Pump adapters .....
Swivels .....	Air Chief ARO .....	223, 224	Pumps .....
Wrenches .....	Air Chief automotive .....	221, 222	Hand hydrotest .....
Pipe	Air Chief industrial .... 215, 216, 217,	218	Hydrostatic
Adapters .... 449, 450, 452, 920, 925,	Air Chief Lincoln .....	225	Accessories .....
926, 929, 939	Air King® .....	180–186, 1095, 1096	Hydrostatic test .....
Bushings .... 449, 923, 924, 925, 939,	Air tanks & manifolds .....	263	PurGel Klear .....
1005	A-series .....	212, 213	Push-in fittings
Caps .....	Bent stem swivel .....	227	Brass .....
Couplings ... 552, 939, 953, 954, 959,	BR-series .....	211	D.O.T. .... 228, 229
960, 961, 969	CJ-series .....	206	Legris .....
Grip-L .....	DF-series .... 197, 198, 199, 200, 201,	1086	D.O.T. .... 230, 231, 232, 233
Hex .....	Dix-Lock® .. 190, 191, 192, 193, 1095,	1098	Kit .....
Merchant .....	D.O.T. air brake .....	233	Modular manifolds .....
Open-Flex 1L .....	D-series .....	198, 199, 200, 201	Nickel-plated brass 246, 247, 252
Threaded .....	Dual-Lock .....	194, 195, 196	Nylon .....
Crosses .....	FRLs .....	2, 288–338	Nylon/nickel-plated brass .... 248,
Elbows 452, 453, 553, 930, 931, 932,	F-series .....	198, 199, 200, 201	249, 250, 252
933, 935, 941	J-series .....	202, 203, 1086	Stainless steel .....
Nipples 450, 451, 452, 551, 926, 927,	L-series .....	208	244, 245
928, 940, 951, 966	M-series .....	204, 205, 1086	Push-loc fittings .....
Plugs .....	Mufflers & vents .....	272	Push-on fittings 216, 217, 221, 222, 223,
Rapp-it repair kits .....	NK-series .....	210	224, 369, 438, 439, 440, 441, 442, 443,
Tees .... 453, 454, 554, 934, 935, 936,	N-series .....	190, 191, 192, 193	444, 445, 1010
941	P-series .....	194, 195, 196	Push to connect fittings .....
Threaded bell reducers .....	Sand blast .....	187	PVC tubing .....
Unions .....	SHD-series .....	207, 208	
Pipe Fittings	Surelock™ .....	188, 189	
Adapters	U-series .....	209	
Weld .....	Valves		
Caps, solid end .....	Legris .....	253, 254, 255	
Clamps	Wilkerson lockout .....	311	
Bolted .....	Polyethylene tubing .....	1001	
Single pin .....	Polypropylene		
Ferrules	Bolted fittings .....	944	
Schedule 5 long .....	Cam & groove .....	86–89	
Schedule 5 short .....	Pipe fittings .....	939–942	
Schedule 10 long .....	Polyurethane		
Schedule 10 short .....	Air hose .....	283, 1088	
Hangers .....	Tubing .....	1001, 1002	
Plugs .....	Pressure guns .....	402, 404	
Ball swivel .....	Probes		
Bull with tap .....	ADS Spillguard .....	147	
Dust, cam & groove .. 30, 50, 80, 177	Process gauges .....	347	
			<b>Q</b>
			Q-Line fittings
			Caps, solid end .....
			Clamps
			Bolted .....
			Single pin .....
			Squeeze .....
			Ferrules .....
			Gaskets .....
			Quick-acting couplings ... 181, 183, 188,
			190–196, 1098
			Quick connect
			Garden hose .....
			Quick disconnects
			Hydraulic
			AG-series .....
			H-BOP-series .....



## Description Index

<i>Sanitary (cont.)</i>	Page #	<i>Sanitary (cont.)</i>	Page #	<i>Sanitary (IX) fittings (cont.)</i>	Page #
180° return bends .....	612	Tube hangers		Tube weld end .....	588
European fittings 646, 647, 648, 688		Sleeves .....	700	Screw pitch gauge .....	1064
RJT BS: 4825 fittings .....	648	Tubing .....	693, 694, 695	Sealant .....	1056
Ferrules		Unpolished fittings ....	625, 626, 627, 628, 629, 693, 694	Joint .....	1056
Bevel seat .....	631, 632, 633, 636	Vacuum fittings .	712, 713, 714, 715, 716, 717, 718, 719, 720	Thread .....	1056
Clamp fittings .....	600, 601	Valves		Security chains .....	72
I-line .....	638, 639	3A sample .....	749	Self-storing air hose .....	282, 283, 1088
Pipe fittings .....	664, 665	Accessories, actuated .....	894	Series 1 FRLs .....	272, 317–338, 1084
Q-line .....	640	Limit switches .....	894	Set screw buckles .....	472
Filter .....	727, 728, 729, 730, 731	Positioners .....	894	Shackles .....	263
Flanges .....	624, 704	Solenoids .....	894	Tectite™ push to connect fittings ...	990, 991
Gaskets		Air blow check, repair kits ....	745	Connectors .....	990
Bevel seat .....	682, 683	Air relief .....	746	Couplings .....	990, 991
Clamp ....	674, 675, 676, 677, 678, 679, 680, 681, 690, 691, 692	Ball		Disconnect clips .....	991
European .....	688, 689	Check .....	744	Elbows .....	991
I-line .....	684, 685	Electrically actuated .	885, 886, 887	End stops .....	991
John Perry .....	686, 687	Electrically actuated, 2-piece ..	885	Tees .....	991
Pipe fitting .....	671, 672	Electrically actuated, 3-piece ..	885	Short shanks ...	368, 370, 371, 373, 421, 1005, 1008
Gauges .....	705–709	Electrically actuated, 3-way ....	887	Shut-off	
Hangers .....	667, 668, 669, 670, 696, 697, 698, 699, 700, 701, 702, 703	Encapsulated .....	736	Valves .....	913
I-line fittings 637, 638, 639, 640, 641, 642		Flow options / patterns ....	893	Sight flow indicators ....	122, 123, 1025, 1026
John Perry ..	643, 644, 645, 673, 686, 687, 723	Multi-port .....	893	Flanged acrylic sight flow indicators	
Laterals, wyes, crosses, bends, and flanges .....	612, 613, 623, 624	Non-encapsulated .....	737	123, 1026	
Pipe fittings .	664, 665, 666, 671, 672	Pneumatically actuated ...	888, 889, 890, 891	Flanged short sight flow indicators	
Protection covers		Pneumatically actuated,		122	
Clamp end .....	613	2-piece .....	888	Repair kits .....	123, 1026
Weld end .....	628	Pneumatically actuated,		TTMA pattern .....	123, 1026
Q-line fittings .....	637, 640, 641	3-piece .....	888	Sight glasses .....	723, 724, 725, 723
Reducers ....	605, 606, 620, 621, 627, 635, 658, 659, 660, 661, 662, 663	Butterfly .	738, 739, 740, 741, 742	Replacement glass .....	724
RTDs and temperature transmitters		Repair kits .....	740, 741	Single bolt clamps .....	478
711		Wafer, pneumatically actuated		Skimmers .....	390
Sight glass .....	723, 724	892		Round hole .....	390
Acrylic end caps .....	723	Check		Sleeves ....	15, 16, 17, 172, 237, 239, 364, 982
Compact .....	724	Air Blow .....	745	Spanner wrenches .....	372
Replacement glass .....	724	Y Ball .....	744	Speed control mufflers .....	271
Seal kit.....	724	Spring check .....	743	Spiral	
HSG hygienic .....	725	Tanker .....	735	Hose and cable protection .....	1067
In-line .....	723	Tank vent .....	747, 748	Hose clamps .....	479
Replacement glass .....	723	Weld fittings .....		Clockwise .....	479
Seal kit .....	723	600, 601, 615, 616, 617, 618, 619, 620, 621, 622, 623, 624, 625, 626, 627, 628, 631, 632, 638, 639, 640, 644, 649, 651, 652, 653, 654, 655, 656, 657, 658, 659, 660, 661, 662, 663, 664, 665, 666, 668, 670, 701, 703, 713, 717, 718, 719, 742, 749		Counter clockwise .....	479
Sight glass end caps .....	723	Sanitary crimp fittings		Spool adapters & couplers	
Spools .....	614	Ferrule, 304 stainless .....	593	Cam & groove .....	81
Spray balls		Sanitary (IX) fittings		Spools	
Rotating .....	722	Ferrule, flow chief .....	590	Sanitary .....	614
Stationary .....	722	Hex nuts .....	589	Spray balls .....	722
Strainers .....	732, 733, 734	Plugs .....	588	Spray hose	
Filters .....	733	Stems		Couplings .....	376, 419
In-line .....	732	Bevel seat .....	589	Spring Guard .....	1018, 1070
Mesh over screens .....	734	Clamp end .....	588	Spring return handle ball valves ....	876, 884
Side-entry .....	732	Male NPT .....	589	Sprinkler	
Side-outlet reverse .....	732			Line tester .....	1062
Swivels				System gauge .....	1062
Straight swivel clamp .....	726			Spuds	
Straight weld connection .....	726			Boss®	
Tanker valve .....	735			Double .....	155, 158, 163
Thermometers .....	710			Female .	153, 154, 157, 163, 1097
				Hose shank .....	160
				Male .....	155, 158, 163



Page #	Page #	Page #
Squeeze Lok™ hose assembly tool .445	Swivel connectors	Tank Truck (cont.)
Stainless steel	Ball .....395	Bearing pack ..... 136
Boss®	Straight .....395	Nose piece ..... 136
Clamps .....161	Swivels ..... 539, 540, 542, 587, 1014	Seal kits ..... 136
Ground joint .....153	37° .....545, 546	Tank cabinet "Dummy" weld-on 1022
Male stem ..... 159, 160	Air King® ..... 184	Tight fill inlet end .....1024
Connections	Air tool .....285	TTMA flange extensions ... 119, 134
Siamese .....841	Angled .....227	Reducing spools ..... 134
Dry disconnect .....99	Angled industrial plugs .....214	Vapor recovery 120, 121, 1033, 1034
Dry quick disconnect ..... 93, 94, 100	Ball, with Air Chief plugs .....214	Tank truck equipment
Ferrules .....448, 579	Ball, with hose barb .....285	Handle kit .....137
Gate valves .....900	Bent stem .....227	Intermodal tank transport .....1038
Gauges .....346, 349, 352	Connectors for spray gun .....395	Tank transport .....1037
GHT adapters ..... 420, 423, 424	Diesel fuel .....112	TTMA flange extensions ..119, 1032
Inserts .....238	Dubl-grip reattachables .....587	Tape .....1055, 1065
Menders .....367	Hose .....1044, 1045	Diameter .....1064
Notched shank cam & groove 36, 37, 44, 45	Hose barb ...426, 428, 431, 432, 438, 440, 441, 442, 443, 444	PTFE tape .....1055
Push-in .....244, 245	In-line .....285	Safety .....1065
Snoots .....841	JIC .....1016	T-Bolt clamps .....466, 467, 468
Strainers .....389	Joints .....128, 129, 130, 131	Technical Data
Swaged fittings .....39, 44	Loading arm .....133, 135	Fraction - Decimal Conversion Chart .....1115
Thermometers .....355	Multi-plane hose .....1045	Temperature Conversions .....1117
Stainless steel cleaner and polish 1058	Push-in fittings ...228, 229, 242, 243	Tees .....543
Steam	Sanitary .....726	Air brake .....237
Gauge siphon .....354	Single plane hose .....1045	BioPharm fittings
Hose couplings .....101	Stems .....447	Clamp x clamp x clamp .....654
Valve, 250 Lb. ....877		Clamp x clamp x clamp instrument .....657
Stems		Clamp x clamp x clamp reducing .....655
Bent swivel .....227		Clamp x clamp x clamp short outlet .....656
External swage ...363, 575, 576, 577	<b>T</b>	Clamp x Clamp x clamp short outlet reducing .....657
Ground joint .....153	Tag, hose assembly .....1065	Weld x weld x clamp .....654
Ground joint air hammer .....163	Tank car	Weld x weld x clamp instrument . .....657
Holedall® DIN external crimp ....591	Fittings, railroad ..119, 123, 124, 125, 126, 127, 1026, 1032	Weld x weld x clamp short outlet .....655
Internal expansion .....580, 581	Gaskets .....127	Weld x weld x clamp short outlet reducing .....656
King combination .....358, 359, 360, 361, 363, 364	Wrenches .....127	Weld x weld x weld .....653
LP Boss® .....160	Tanker valve .....735	Weld x weld x weld reducing 653
Reusable brass .....446, 447, 448	Tank transport equipment	Bull head .....935
Sanitary style .....588, 589, 591, 592	Pipe caps .....1037	Clamp fittings .....604
Washer seal .....157	Reducers .....1037	Compression .....981, 982
Strainers .....389, 390, 391	Reducing cap .....1037	Female reducing .....935
Disk .....72	Tank truck	Female threaded .....934
Polypropylene .....389	Breakaways .....1045	Flare .....986
Round hole .....389	Coupler x round flange ....119, 1032	Hydraulic .....540, 547
Sanitary .....732, 733, 734	Diesel nozzles .....1046	Flat face .....540
Square hole .....389	Drop elbows 1020, 1022, 1023, 1024	NPTF .....554
T line .....970	Elbows .....1020, 1021, 1022, 1023, 1024	ORB fittings .....541, 542, 543
Witches hat .....72	Flanged tee .....1031	Instrumentation .....976
with spring loaded check valves 914	Gaskets .....122, 1025	LIQUIfit™ .....993, 994, 995
Y Line .....970	Nozzle accessories, fuel 1043, 1045	Mechanical .....963
Straps	Nozzles .....1041, 1042, 1043, 1046, 1047, 1048, 1049	Push-in 229, 232, 233, 242, 245, 247, 251, 252, 257, 258
King Cable® .....262	Straight drop fuel delivery .....1021	Sched. 80 polypropylene .....941
Straub pipe couplings .....953, 954	Swivels .....130, 133	Side outlet .....935
Stretch strap .....1066	Split flange .....136	Splicers .....430
Suction hose couplings ...370, 371, 377	Split flange components .....136	Street service .....935
Boss® LPS .....166		Threaded side outlet .....935
Super King shank couplings .....372		
Surelock™ quick acting couplings ...188, 189		
Swaged fittings 155, 574, 575, 576, 577, 578, 579		
Swaging machines .....572		



Valves (cont.)	Page #	Valves (cont.)	Page #	Weld fit. (cont.)	Page #
Check ...	255, 276, 561, 912, 913, 914	Air & vacuum relief .....	747, 748	Flanges .....	624
800 PSI stainless steel .....	913	Three way gauge .....	1062	Laterals .....	623
Air blow .....	745	True Seal™ .....	996, 997	Reducers	
Air relief .....	746	Wafer .....	903	Concentric .....	620
True Seal™ .....	997	Wilkerson lockout .....	311	Eccentric .....	621
Y Ball .....	744	Vapor recovery couplers 120, 121, 1033,		Sweep elbows .....	617
Compact polypropylene .....	899	1034		Tees	
Composite mini ball .....	253	Repair kits .....	120, 121	Clamp x weld .....	619
Compressor Y .....	267	Velcro® straps .....	73	Long .....	618
Deadman handle .....	876, 884	Vent		Reducing .....	618
Domestic gate .....	900	Breather .....	271	Short .....	618
Dual Y ball .....	880	Stationary .....	1036	Weld x clamp run x clamp branch	
Fire		Vent-Lock® .....	29, 30, 31, 176, 177, 178	619	
2-Way ball .....	863			True wyes .....	623
Angle .....	852, 853, 854, 855, 865, 869			Unpolished	
Chicago pattern .....	870			Elbows	
Drain .....	871			45° .....	625
Drip .....	864			90° .....	625
Gate .....	856, 857, 858, 859, 860			180° return bends .....	628
Globe .....	864, 866			Laterals .....	628
Piston intake relief .....	872			Reducers	
Pressure reducing .....	867, 868			Concentric .....	627
Pressure restricting .....	869			Eccentric .....	627
Sprinkler hose .....	871			Tees	
Wye .....	861, 862			Long .....	626
Flanged .....	898			Reducing .....	626
Flow control 253, 254, 276, 560, 904,				Short .....	626
905				True Wyes .....	628
Metering .....	560, 904			Type A stub ends .....	629
Foot .....	391			Welding	
Garden hose ...	416, 417, 1078, 1080			Gauges .....	353
Gate .....	900			Metal hose fittings .....	950
Globe .....	901			Nipples .....	951
Grooved end iron butterfly .....	966			Whip hose .....	265, 1101
High pressure .....	561, 897			Whipsocks .....	263
Zinc ball .....	561			Shackles .....	263
High pressure hydraulic ball .....	561, 897			Wilkerson FRLs 288, 289, 290, 291, 292,	
In-line check .....	255			293, 294, 295, 296, 297, 298, 299, 300,	
In-line flow control .....	253, 254			301, 302, 303, 304, 305, 306, 307, 308,	
Lead free brass ball .....	879			309, 310, 311, 312, 313, 314, 315, 316	
Locking handle .....	876			Witches hat strainers .....	72
Needle				Worm gear clamp rack .....	464
Hydraulic				Worm gear clamps .. 460, 461, 462, 463,	
Bleed .....	563, 907			464, 465	
Block and bleed .....	563, 907			Marine grade .....	461
Mini .....	562, 906			Wrenches	
Multiport .....	562, 906			Bevel seat .....	630
Pneumatic				European .....	647, 648
Needle .....	273, 909			John Perry .....	643
Polypropylene .....	898, 899			Pin lug .....	127, 372
Quick exhaust .....	253			Spanner .....	372, 972
Safety check .....	270, 910, 1099			Wrench grips .....	952
Safety pop-off .....	275, 911, 1095			Wyes .....	250, 251
Safety vented .....	877, 1101				
Shut-off .....	314				
Solder end .....	879				
Spring loaded .....	913, 914				
Swing check .....	914				
Tanker .....	735				
Tank filler .....	274, 908				
Tank vent					

**W**

Description Index

	Page #	Page #	Page #
<b>Y</b>			
Y, compressor .....	267		
Y, connectors .....	233, 258		
Y, dual valve .....	880		
Y, garden hose coupler .....	416, 1080		
Y, garden hose valve .....	416, 1080		
Y, GHT .....	416		
Y line strainers .....	970		
Y, unions .....	233		
<b>Z</b>			
Zerk fittings .....	457		

Page #	Page #	Page #	Page #
<div style="border: 1px solid black; padding: 5px; width: fit-content;">                     In the following index, a (•) is used to represent a variable. Therefore, to find AD075EZ or AD400EZ, look for: AD••EZ                 </div>	•HBF•-S ..... 481	•SFSK-TESS ..... 136	•VOF• ..... 494
	•HBF•-SS ..... 481	•SFSK-VI ..... 136	•V-RKIT ..... 502
	•H-BRKIT ..... 487	•STBF• ..... 512	•V-SKIT ..... 501
	•HDP-A ..... 485	•STBF•• ..... 512	•V-SSRKIT ..... 502
	•HDP-H•DC ..... 485	•STBF••-SS ..... 512	•WBF•-B ..... 520
	•HF• ..... 481	•STBF•-SS ..... 512	•WBF•-B-HN ..... 520
	•HF•-B ..... 481	•ST-BMK ..... 514	•WDP ..... 521
	•HF•-BOP ..... 488	•STDP-A ..... 514	•WF•-B ..... 520
	•HF•-S ..... 481	•STF• ..... 512	•WF•-B-HN ..... 520
	•HF•-SS ..... 481	•STF•• ..... 512	•W-RKIT-V2 ..... 522
	•HF•-SS-BOP ..... 488	•STF••-SS ..... 512	•WSBF• ..... 523
	•HOF• ..... 481	•STF•-SS ..... 512	•WSBF•-SS ..... 523
	•H-RKIT ..... 487	•STOF• ..... 512	•WSDP-A ..... 525
	•HSBF•-B ..... 489	•STOF•• ..... 512	•WSF• ..... 523
	•HSBF•-S ..... 489	•ST-SKIT ..... 514	•WSF•-BOP ..... 526
	•HSF•-B ..... 489	•TDDP-A ..... 530	•WSF•-SS ..... 523
	•HSF•-S ..... 489	•TDF•-SS ..... 530	•WSF•-SS-BOP ..... 526
	•H-SKIT ..... 486	•TDP ..... 528	•WSFH• ..... 524
	•H-SRKIT ..... 487	•TDPF••-SS ..... 530	•WSFP• ..... 524
	•H-SSRKIT ..... 487	•TM• ..... 527	•WSOF• ..... 523
	•HTBAND• ..... 504	•TRBF• ..... 503	•WS-RKIT ..... 525
	•HTBF• ..... 505	•TRF• ..... 503	•WS-SKIT ..... 525
	•HTBF•• ..... 505	•TR-SKIT ..... 503	••TDDP-A ..... 530
	•HTBF••-SS ..... 505	•T-SKIT ..... 528	••BOP-SKIT ..... 526
	•HTBF•-SS ..... 505	•VBF• ..... 494	••CVVBF•• ..... 529
•HTDP ..... 507	•VBF•-B ..... 494	••CVVDP ..... 530	
•HTF• ..... 505, 1091	•VBF•-B-E ..... 497	••CVVF•• ..... 529	
•HTF•• ..... 505	•VBF•-E ..... 497	••EF••-B ..... 399, 531	
•HTF••-SS ..... 505	•VBF•-SS ..... 494	••EF••-S ..... 399, 531	
•HTF•-FS ..... 507	•VBF•-SS-E ..... 497	••EM••-B ..... 399, 531	
•HTF•-SS ..... 505	•V-BRKIT ..... 502	••E-SKIT ..... 401, 533	
•HTJB• ..... 507	•VDP-A ..... 500	••HBF•• ..... 483	
•HTM• ..... 505	•VDP-V•DC ..... 500	••HBF••-B ..... 483	
•HTOF• ..... 505, 1091	•VEPBF• ..... 516	••HBF••-S ..... 483	
•HTOF•• ..... 505	•VEPDP-A ..... 517	••HBF••-SS ..... 483	
•HTOM• ..... 505	•VEPF• ..... 516	••H-BRKIT ..... 487	
•HTRB• ..... 507	•VEPF•-BOP ..... 519	••HDP-A ..... 485	
•HT-SKIT ..... 508	•VEPFH• ..... 518	••HF•• ..... 483	
•JF•-B ..... 1086	•VEPFP• ..... 518	••HF••-B ..... 483	
•KBF• ..... 490	•VEPOF• ..... 516	••HF••-S ..... 483	
•KBF•-SS ..... 490	•VF• ..... 494	••HF••-SS ..... 483	
•KDP-K•DC ..... 491, 500	•VF•-B ..... 494	••HOF•• ..... 483	
•KF• ..... 490	•VF•-B-E ..... 497	••H-RKIT ..... 487	
•KF•-SS ..... 490	•VF•-E ..... 497	••H-SKIT ..... 486	
•KOF• ..... 490	•VF•-SS ..... 494	••H-SRKIT ..... 487	
•K-SKIT ..... 491	•VF•-SS-E ..... 497	••H-SSRKIT ..... 487	
•MF•-B ..... 1086	•VJM• ..... 495	••HTBF•• ..... 505	
•PDF• ..... 515	•VM• ..... 495	••HTF•• ..... 505	
•PDM• ..... 515	•VM•-B ..... 495	••HTOF•• ..... 505	
•SFBP ..... 136	•VM•-B-E ..... 498	••KBF•• ..... 490	
•SFNPCS ..... 136	•VM•-E ..... 498	••KF•• ..... 490	
•SFNPSS ..... 136	•VM•-SS ..... 495	••K-SKIT ..... 491	
•SFSK-BAYLAST ..... 136	•VM•-SS-E ..... 498	••STBF•• ..... 512	

# Part Number Index

	Page #		Page #		Page #		Page #
•STF•	512	0••	475, 476, 1001	100GTHK	69	1231-••••	541
•STOF•	512	0•••	1001	100-HP-SP	66	1234-••••	545
•VBF•	494	0••R	475	100PRSCSS	72	1238-••••	542
•VBF•-B	494	001-••••	456	100TP	1061	124•••K	428
•VBF•-B-E	497	0010••C	456	1010-6	778, 1068	1240-••••	543
•VBF•-E	497	0304C-•	548	1012CIPUSH	1059	125-•	68
•VBF•-SS	494	0304C-••	548	1015-DA-••	53	1250-94	1043
•VBF•-SS-E	497	0306-•	549	102•••BSPT	427	1250SK	1043
•VDP-A	500	0306-••	549	102•••C	426	1251-••H	555
•VEPBF•	516	0318-•	548	102•••CLF	426	1254-••H	548
•VEPDP-A	517	0318-••	548	102•••SS	426	1255-••H	543
•VEPF•	516	0319-•	548	1020604C	1085	125-A-••	32
•VEPF•-BOP	519	0319-••	548	10210-64	778, 1068	125-AA-••	55
•VEPFH•	518	0610-4	778, 1068	1025P•••	257	125-B-••	33
•VEPF••	518	0817••	1001	103-••••	426	125-C-••	35
•VEPOF•	516	0817BL100	1001	103•••C	426	125C-90••	59
•VF•	494	09-31-00001	850	104•••C	427	125-D-••	40
•VF•-B	494			104•••CLF	427	125D-90••	59
•VF•-B-E	497			104•••SS	427	125-DP-••	50
•VF•-E	497	1•	478	105-••••	432	125-E-••	43
•VF•-SS	494	1••	475	105•••C	432	125-F-••	46
•VF•-SS-E	497	1•••	475, 476, 477, 1001	1091P••••	1002	125-G-••	69, 70
•VJM•	495	1••••	461, 1001	1091U••••	1002	125-G-•••	69, 71
•VM•	495	1••R	475	1091U••R00	1002	125GTFACC	71
•VM•-B	495	1••R	475	1092T••••	1002	125GTFVI	70
•VM•-E	498	100-•	68	1094P••••	1002	125GTHK	69
•VM•-SS	495	10-076-004	329	1094U••••	1002	126-••••	428
•VM•-SS-E	498	100-A-••	32	1094U••R00	1002	126•••C	428
•VOF•	494	100-AA-••	55	10-DBHU-10	975	128P•LJ15	576
•V-SKIT	501	100-A-HA	51	10-DCAP	977	128P•S015	576
•WBF•-B	520	100-AL-••	61	10-DELU-10	976	129•••C	429
•WBF•-B-HN	520	100AWBPST••	63	10-DFC-•	974	129•••CLF	429
•WDP	521	100AWSP••	63	10-DFPLUG	977	129•••SS	429
•WF•-B	520	100-B-••	33	10-DMC-•	974	12-DBHU-12	975
•WF•-B-HN	520	100BHAN-AL	133	10-DTTT-10	976	12-DCAP	977
•W-RKIT-V2	522	100-C-••	6, 35	10-DU	975	12-DELU-12	976
•WSBF•	523	100-D-••	40	11-009-•••	326	12-DFC-•	974
•WSBF•-SS	523	100D-90••	59	1125A	1041, 1042	12-DFC-••	974
•WSDP-A	525	100DA-90••	58	112D	1042	12-DFE-12	975
•WSF•	523	100-DC-••	47	112DNS	1042	12-DFE-8	975
•WSF•-BOP	526	100DHAN-AL	133	112DSK	1042	12-DFPLUG	977
•WSF•-SS	523	100-DL-••	61	1143A	1041, 1042	12-DMC-•	974
•WSF•-SS-BOP	526	100-DP-••	50	114D	1042	12-DMC-••	974
•WSFH•	524	100DWPST••	62	114DNS	1042	12-DME-12	975
•WSFP•	524	100DWSP••	62	114DSK	1042	12-DME-8	975
•WSOF•	523	100-E-••	7, 43	1204-••••	544	12-DRATT-16	975
•WS-RKIT	525	100-E-HA	51	1208••	1001	12-DRATT-8	975
•WS-SKIT	525	100-F-••	46	1217AR-•	264	12-DTMT-••	976
•••-B-ALNST	85	100-F-HA	51	1217AR-4••	264	12-DTTM-12	976
•••-D-ALNST	85	100-G-••	69, 70	1217AR-4AK-KSW	263	12-DTTM-8	976
•••-F-ALNST	85	100-G-•••	69, 71	1217AR-4AKWF	265	12-DTTT-•	976
		100GTFACC	71	1217FRAME	264	12-DTTT-12	976
		100GTFVI	70	12275	1001	12-DU	975

	Page #		Page #		Page #		Page #
12P	577	13NHN-G100-600	698	14-G	631	1501	553
13	598	13NHN-G75	698	14MPHR-G	609	1501	553
13	599	13PS	700	14MPHR-G	609	1502	553
1310-8	778, 1068	13PS	700	14MPHR-G	609	1502	553
134	429	13PV	667	14MPHR-G	609	1503	553
134	429	13PV-75	667	14MPHRL	609	1503	553
139	431	13RBN-G	648	14MPHRL	609	15030FXF	130
139	431	13RG	698	14MPHR-R	609	150-A	32
13BNH	599	13R-G	646	14MPHR-R	609	150A-90	58
13CB	599	13R-G	647	14MPHR-R	609	150-AA	55
13H-G	630, 643	13RG3/8	698	14MPHR-R	609	150-A-ALH	32
13H-G	648	13RGV	698	14MPHR-R	609	150-A-HA	51
13HS	700	13RP	599	14MPHT-R	608	150-AL	61
13HS	700	13RP6	599	14MPHT-R	608	150AWBPST	63
13IB	599	13SCC	595	14MPHT-R	608	150AWSP	63
13IB6	599	13SCC	595	14MPW-R	601	150-B	33
13ILB	637	13SCC	595	14MPW-R	601	150B-90	59
13ILB100-150	637	13SCC	595	14PRF-G	631	150B-ALH	33
13ILH	637	13SCC	595	14PRFJP-G	644	150-C	6, 35
13ILH100-150	637	13SCC-CB	595	14PRFJP-R	644	150-C	59
13IL-Q100150	637	13SN	599	14PRF-R	631	150C-90	59
13IL-Q200	637	13WGC	598	14R-G	631	150-C-ALH	35
13LW	599	13WGC100-150	598	14RMP-G	601	150CNOSSS	36
13MHHM	596	13WNH	599	14RMP-R	601	150-D	40
13MHHM	596	13WNS	599	14VB-R	629	150D-90	59
13MHHM	596	13WNX	599	14VB-R1000	629	150DA-90	58
13MHHM	596	14003	502	14VB-R50	629	150-D-ALH	40
13MHHM100-150	596	1404	552	14W-G	632	150-DC	47
13MHHM100-150SN	596	1404	552	14WHI-G	638	150-DC-ALH	47
13MHHM100150WNH	596	1404	552	14WHI-R	638	150DC-L	48
13MHHM-3P	597	1404	552	14WHRL-R	622	150-DD	55
13MHHM-3P100150	597	1405	552	14WHR-R	622	150-DL	61
13MHHM-3P1200	597	1405	552	14WHR-R	622	150-DP	50
13MHHM50-75	596	1405	552	14WI-G	638	150-DP-ALH	50
13MHHM50-75SN	596	142	431	14WI-R	638	150DWBPST	62
13MHHM50-75WNH	596	1420	431	14WL-G	632	150DWSP	62
13MHHM-DP	597	143	431	14WLI-G	638	150-E	7, 43
13MHHM-DP1000	597	1430	431	14WLI-R	638	150-E-ALH	43
13MHHM-DP100150	597	1430407KLF	431	14WLMP-G	601	150-E-HA	51
13MHHM-Q	596	144	432	14WLMP-R	601	150ENOSSS	45
13MHHM-Q100150	596	144	432	14WLMP-R	601	150-F	46
13MHHM-Q75	596	144F	986	14WMP-G	600	150F	985
13MHHV	664	145	432	14WMP-G	600	150F-90AL	60
13MHHV	664	145	432	14WMP-G	600	150-F-ALH	46
13MHLA	597	149F	985	14WMP-R	600	150-F-HA	51
13MHLA100-150	597	149F	985	14WMP-R	600	150-G	69, 70
13MHP	597	149F	985	14WMP-R	600	150-G	69, 71
13MHP	597	14A-G	631	14WMV-R	664	150GPCTF	1037
13MHP100-150	597	14AHR-G	636	14WMX-R	664	150GTF	70
13MHP75	597	14AHT-G	636	14WQ-G	640	150GTFACC	71
13MHPV	664	14A-R	631	150	68	150GTHK	69
13MO	598	14A-R	646	1500SK	1044	150TP	1061
13MO	598	14A-R	648	1501	553	1510-B	56
13MO100-150	598	14A-R	647	1501	553	1510-C	56

# Part Number Index

	Page #		Page #		Page #		Page #
1510-D**	57	166FSV***	985	176C-0402	982		
1510DAAL	53	169****	453, 931	177****	430		
1510-DA-SS	53	1690**C	453, 931	177**C	430	2	478
1510-E**	57	169C****	980	177**SS	430	2*	478
1520**K	458	16A-G**	636	177****SS	430	2**	475
1520-AA**	55	16AI-14I**	641	177C-0402	981	2***	475
1520-DA**	53	16AI-14I**R	641	178**C	368, 419, 428	2****	380, 461
1520-F**	57	16AI-15I**	641	178**SS	368	2*****	334, 335, 336
1540**K	458	16AI-15I**R	641	1780*0*CLF	368, 428	2**R	475
156	162	16AJP-G**	645	1781212C	1078	2**R	475
156****	458	16AJP-R**	645	179****	430	200*	68
1560**C	458	16AMP-G**	607	179**C	430	200**C	433
1565U	1044	16AMP-G***	607	179**SS	430	200L	1035
158****	458	16AMP-G100-150	607	179****SS	430	200-A**	32
1580**C	458	16AMP-G50-75	607	1790**CLF	430	200-A**SWIV	25
159F**	986	16AMP-R**	607	1790604BARB	430	200A-90**	58
15A-G**	632	16AMP-R***	607	179C****	980	200-AA**	55
15AHT-G**	636	16AMP-R**DIN	646	17MP-14-G**	608	200-A-ALH	32
15A-R**	632	16AMP-R**SMS	647	17MP-15-G**	608	200-A-HA	51
15A-R**DIN	646	16AMP-R100-150	607	18*****	336, 338	200-AL**	61
15A-R**RJT	648	16AMP-R50-75	607	18*57	344	200-AL-SSANSI	61
15A-R**SMS	647	16AMV-G**	665	180****F	448	200AWBPST**	63
15B15-100**	758	16AMV-R**	665	180**FSS	448	200AWSP**	63
15B15-50**	758	16AQ-G**	641	182**S	448	200-B**	33
15-G**	633	16A-R**	636	182**SS	448	200B-90**	59
15R-G**	633	16-DBHU-16	975	183**K	446	200-B-ALH	33
15TRF-G**	632	16-DCAP	977	183**KSS	446	200-C**	6, 35
15TRFJP-G**	644	16-DELU-16	976	184**A	447	200C-90**	59
15TRFJP-R**	644	16-DFC**	974	18-458-00017	866	200-C-ALH	35
15TRF-R**	632	16-DFE-16	975	185****	447	200CNOSSS	36
15W-G**	633	16-DFPLUG	977	185**K	447	200-D**	40
15WHI-G**	639	16-DMC**	974	186**S	447	200D-90**	59
15WHI-R**	639	16-DME**	975	187	162	200DA-45**	58
15WI-G**	639	16-DTMT-16	976	187****	447	200DA-90**	58
15WI-R**	639	16-DTTM**	976	187**K	447	200-D-ALH	40
15WL-G**	633	16-DTTT**	976	188**	567	200DBAL	783
15WLI-G**	639	16-DU	975	189	777, 829	200-DC**	47
15WLI-R**	639	16P*	577	189DH	829	200-DC-ALH	47
15W-R**	633	16STDP-A	514	1910-12	778, 1068	200DC-L**	48
1610-10	778, 1068	16STF16-SS	512	1A**B	212	200-DD**	55
163**00C	455, 938	16ST-SKIT	514	1AS1-B	213	200DD-45**	58
1630*00CLF	455, 938	17-016-107	333	1BRBF*-B-7	211	200DD-90**	58
16375	1001	170C****	980	1BRF*-B-7	211	200-DL**	61
164C**	981	17-14I-14MPG**	642	1BRGM*-B-7	211	200-DP**	50
164C*****	981	17-15I-14MPG**	642	1BRM*-B-7	211	200-DP-ALH	50
165****	450, 927	171C****	982	1BRS**B-7	211	200DWBPST**	62
165**C	450, 927	172**C	452, 929	1HDP	485, 500	200DWSP**	62
165**CLF	450, 927	172C****	981	1-HR1004	287	200-E**	7, 43
165C**	981	174****	450, 926	1-HR1004-3	287	200-E**SWIV	25
166****	451, 926	1740**C	450, 926	1-HR1004A	287	200E-90**	60
166**C	451, 926	176****	452, 929	1WAYBV**	895, 1050	200-E-ALH	43
166**CLF	926	1760**C	452, 929	1WAYBV**SW	895, 1050	200-E-HA	51
16604**CLF	451	1765A	435	1WAYBV**VIC	895, 1050	200ENOSSS	45



	Page #		Page #		Page #		Page #
200-F**	46	21MP-G***	610	2501-***	546	275	162
200F-15**	60	21MP-G****	610	2501-***	546	278****C	440
200F90AL	60	21MP-G*****	610	2501-***	546	278****CBC	440
200F-90SS	60	21MP-G100-125	610	2501-***	546	280****	440
200-F-ALH	46	21MP-R**	610	2503-**-	547	280****C	440
200-F-HA	51	21MP-R***	610	2503-***	547	280****CBC	440
200-G**	69, 70	21MP-R****	610	2503-****	547	282****	441
200-G***	69, 71	21MP-R*****	610	250-A**	32	282****C	441
200GPC**	1037	21MP-R*****	610	250-B**	33	282****CBC	441
200GTF**	70	21MP-R100-125	610	250-C**	35	284****	442
200GTFACC	71	2210-14	778, 1068	250-D**	40	284****C	442
200GTHK	69	2211CBB*****F1	658	250-DC**	47	284****CBC	442
200GTTFBL	122	2211CBB*****F4	658	250-DP**	50	286****	442
200-HRP**	66	2211EBB*****F1	659	250-E**	43	286****C	442
200-HSCR-P-SI	66	2211EBB*****F4	659	250-F**	46	286****CBC	442
200-LH**	66	2221CBB*****F1	658	250-G**	69, 70	287****	443
200-PC**	1037	2221CBB*****F4	658	250-G***	69, 71	287****C	443
200PRSC**	72	2221EBB*****F1	659	250GTF**	70	287****CBC	443
200-PV-9	1035	2221EBB*****F4	659	250GTHK	69	287****SS	443
200-TCA**	126	2226CBB*****F1	660	2510-16	778, 1068	287****SS	443
200TP	1061	2226CBB*****F4	660	2520-A**	56	2870407CLF	443
200YDAAAL	64	2226EBB*****F1	660	2520-DA**	53	288****	443
2010-DA**	53	2226EBB*****F4	660	2530-AA**	55	288****C	443
2015-A**	56	225	162	2530-DA**	53	288****CBC	443
2015-B**	56	228****	454, 936	2540-AA**	55	288****SS	443
2015-B-ALNST	815	228****C	454, 936	25933AL	902, 1052	288****SS	443
2015-C**	56	22MP-G**	611	25H***	630, 643	289****	443
2015-D**	57	22MP-G****	611	25H*****	630, 643	289****C	443
2015-DA**	53	22MP-G*****	611	2601-***	547	289****SAE	443
2015-E**	57	22MP-G100-125	611	2601-****	547	2890***SAE	443
2015-F**	57	22MP-R**	611	2601-*****	547	28957ALEY	1052
2025-DA**	53	22MP-R***	611	2603-*	547	28967ALEY	902
2025-D-ALNST	815	22MP-R****	611	2603-**	547	28981ALEY	902, 1052
2025-F-ALNST	815	22MP-R*****	611	26287AL	902, 1052	290****	444
2030-A**	56	22MP-R*****	611	264C-03	981	290****C	444
2030-AA**	55	22MP-R*****	611	268B****	427	290****CBC	444
2030-ALT-AL	119	22MP-R50-125	611	269C****	980	292****C	444
2030-B**	56	230FXF**00000	130	2700LN*	548	292****CBC	444
2030-DA**	53	233	777, 828	2700LN**	548	292-0**	444
2030-DD**	55	234-80*	1042	2701LN*	549	294****	444
2030-F**	57	2404-**-	544	2701LN**	549	294****C	444
2040-AA**	55	2404-***	544	270AT	445	294****CBC	444
2040-DA**	53	2404-****	544	271****	438	294****SS	444
206	162	2405-**-	544	271****C	438	294****SS	444
207BH*	943	2405-***	544	272****C	438	296****C	440
207BH**	943	2405-****	544	272****CBC	438	296****CBC	440
207BH***	943	2405-*****	544	272****SS	438	296****SS	440
211****C	455, 938	24PFX* **	590	272****W	445	2A*-B	212
212	162	250	162	2720**CLF	438	2AE2-B	213
213**00CLF	454, 937	250*	68	273****	439	2AS2-B	213
2143SEALBU	1029	2500HB0000	586	273****C	439	2CJBF*-B	206
219****	455, 938	2500L	1035	274****C	439	2CJBM*-B	206
219**00C	455, 938	2500SFV	1036	274****CBC	439	2CJF*-B	206

# Part Number Index

	Page #		Page #		Page #		Page #
2CJF2-B	280	2WAYBV200-SH	896	300-DC-ALH	47	300-TFA	1028
2CJM-B	206	2WAYBV200SW-SH	896	300DC-L	48	300-TFG	1024
2CM4S2.5-B-E	537	2WCA-F	846	300-DD	55	300TP	1061
2CM9S2.5-B	538	2WCA-F-SP	846	300DD-45	58	3010-RC-SS	1037
2CM9S2.5-B-E	538	2WSA-F	846	300DD-90	58	3014	248
2CMS2.5-B	536	2WSA-F	846	300-DL	61	3015-DA	53
2CMS2.5-B-E	536			300-DLT-AL	119, 1032	3015-F	57
2D-B	198, 199, 201	3	478	300-DP	50	302-C	452, 930
2D-S	198, 199	3	475	300-DP-ALH	50	302-CLF	452, 930
2DB-B	198, 199	3	383, 384, 475	300DWPST	62	3020-A	56
2-DFC	974	3	383, 384, 461	300DWSP	62	3020-B	56
2-DMC	974	3	333, 334, 335, 336	300-E	7, 43	3020-C	56
2DS-B	200	3-R	475	300-E-SWIV	25	3020-D	57
2DS-S	200	3-R	475	300E-90	60	3020-DA	53
2-DTMT-2	976	30-RDSSAP	1038	300-E-ALH	43	3020DAT-SS	54
2-DTTM-2	976	300	68	300-E-HA	51	3020-E	57
2-DU	975	300	252	300EL90	930	3020-F	57
2FB-B	199	3000	355	300EL90	930	3020-RD	1037
2FB-B	201	3002	119	300ENOSSS	45	3025-A-ALNST	85, 815
2FBF-B	198	30022ALTAL	1024	300-F	46	3025-B-ALNST	815
2FF-B	198	300300MAE	355	300F-90SS	60	3025-C	56
2FF-S	198	3004	1024	300-F-ALH	46	3025-DA	53
2FF2	198	3004030MAE	355	300-F-HA	51	3025-D-ALNST	815
2FM-B	199	3006	249, 355	300FT	934	3025-E	57
2FM-S	199	3009	32	300FT	934	3025-F-ALNST	815
2FM2	199	300-A	25	300-G	69, 70	304-C	453, 931
2FS	200	300-A-SWIV	58	300-G	69, 71	3040-CLF	453, 931
2FS-B	200	300A-90	55	300G-PC	1037	3040-A	56
2FS-S	200	300-AA	32	300GTF	70	3040-AA	55
2FS2.5-B	200	300-A-ALH	51	300GTFACC	71	3040ALTAL	119, 1032
2-HR1004-3	287	300-A-HA	61	300GTHK	69	3040-B	56
2-HR1005	287	300-AL	61	300GTHKBF	70, 1030	3040-C	56
2JB-B	203	300-AL-SSANSI	61	300GTTFBL	122, 1025	3040-DA	53
2JF-B	203	300-ALT	119, 1032	300GTTFCB	122, 1025	3040-DD	55
2JM-B	203	300ASSSAP	1038	300GTTFK	122, 1025	3040DLTAL	119, 1032
2JS-B	203	300AWBPST	63	300GTTFTK	122, 1025	3040-F	57
2L-2-B	208	300AWSP	63	300H-PAD	67	306	162
2MF-B	204	300-B	33	300-HRP	66	306	453, 933
2MF-PL	204	300B-90	59	300-HSCR-PSI	66	306-C	453, 933
2MM-B	205	300-B-ALH	33	300-LH	66	3060-DA	53
2MM-PL	205	300BR	919	300-MAE	1024	31	267
2MS-B	205	300-C	6, 35	300MICAP	937	3101	257
2MS-PL	205	300C-90	59	300MICAP	937	3102	251, 258, 355
2MS2.5-PL	205	300-C-ALH	35	300MIU	922	3102-DOT	231
2NK	210	300CNOSSS	36	300MIU	922	3103	250
2NKB	210	300-D	40	300-PC	1037	3103-DOT	233
2SHD	207	300D-90	59	300PC-AP	1038	3104	251, 252, 258, 355
2SHDS	208	300DA-45	58	300PRSC	72	3104-DOT	232
2U-B	209	300DA-90	58	300RHC	921	3106	251, 252, 257
2UB-B	209	300-D-ALH	40	300RHC	921	3106-DOT	231
2WAYBV	896, 1051	300DAT-SS	53	300-SFC	1037	3108	250, 257
2WAYBV-SW	896, 1051	300DBAL	783	300SSSG	398	3108-DOT	232
2WAYBV-VIC3	896, 1051	300-DC	47	300-TCA	126	3109	249, 252, 256

	Page #		Page #		Page #		Page #
3109••••DOT	231	35HTFXTFAL••••	133	3JS•	203	400-CVR-AL	120, 1033
3113••••	249	3601••••	246	3MF3-PL	204	400-D••	40
3114••••	256	3602••••	247	3MM•-PL	205	400D-90••	59
3114••••DOT	230	3603••••	247	3MS3-PL	205	400DA-45••	58
3115••••DOT	230	3604••••	247	3NBM4	191	400DA-90••	58
3116••••	251, 257	3606••••	246	3NCS4	191	400-D-ALH	40
3116••••DOT	231	3609••••	247	3NM4	191	400-DC••	47
3126••••	251, 258	3615••••	246	3N-SKIT	192	400-DC-ALH	47
3129••••	249	3675••••	246	3S--15U-GFB•SS	707	400DC-L••	48
3140••••	251, 252, 258	36930420	247	3S--2U-GFB•SS	707	400-DD••	55
3140••••DOT	233	370••••C	451, 928	3TF3	527	400DD-45••	58
31440-225AL	1029	3700••CLF	451, 928	3TM3-PV	527	400DD-90••	58
3148••••	250	371••••C	449, 922	3TM3-SS	527	400-DDVR-AL	120, 1033
3148••••DOT	233	3710••CLF	449, 922	3TM3-SS-PV	527	400-DL••	61
31665660DOT	232	373••••C	264, 449, 925	3U••-B	209	400-DLT-AL	119, 1032
3175••••	248, 252, 256	373••••CLF	449, 925	3UB••-B	209	400-DP••	50
31825600DOT	232	375	162	3XKF3	511	400-DP-ALH	50
31835600DOT	233	375••••C	450, 925			400-DVR-AL	121, 1034
3199••••	258	375••••CLF	450, 925			400DWPST••	62
320TFXTFAL••••	133	377••••C	449, 920			400DWSP••	62
3210-20	778, 1068	377••••CLF	449, 920	4	478	400DWX5TC	125
322••••	453, 934	379••••C	452, 928	4••	475, 477	400-E••	7, 43
322••••C	453, 934	38025600	245	4••••	465	400-E••SWIV	25
322••••CLF	453, 934	3804••••	245	4•••••	333, 334, 335, 336, 337, 338	400E-90••	60
324••••	454, 936	3805••••	244	4•••••	334, 335, 336, 337	400-E-ALGT	1030
324••••C	454, 936	3806••••	244	4•••••R	333, 334, 336	400-E-ALH	43
326••••	454, 936	3810-24	778, 1068	4•••••RF	333	400-F••	46
326••••C	454, 936	3816••••	244	4•••••RL	336	400-F-ALH	46
3260404CLF	454, 936	3889••••	245	4••R	475	400-G••	69, 70
32P•LJ15	576	391137	1041	40••REV90	842	400-G•••	69, 71
32P•SO15	576	3CJBF•-B	206	400••	68	400GAGFI	64
32PFX••••	590	3CJBM•-B	206	400••-ALGT	1030	400-G-BUSS	124
330FXF••00000	130	3CJF•-B	206	40022ALTAL	119, 1032	400GPCTF	1037
330TFXTFAL••••	133	3CJM•-B	206	40022DLTAL	119, 1032	400GTF••	70
33155614	252	3D••-B	198, 199, 201	400-A••	32	400GTHK	69
33BTFTXFAL••••	133	3D••-S	198, 199	400-A••INSERT	32	400GTHKBF	70, 1030
33HTFXTFAL••••	133	3DB••-B	198, 199	400-A••SWIV	25	400GTTFBL	122, 1025
340TFXTFAL••••	133	3DS•-B	200	400A-90••	58	400GTTFCB	122, 1025
34BTFTXFAL••••	133	3DS•-S	200	400-AA••	55	400GTTFK	122, 1025
34HTFXTFAL••••	133	3FB•	201	400-A-ALH	32	400GTTFTK	122, 1025
35••	226	3FBF3	198	400-A-INSERT	73	400-LH••	66
35•••••	415	3FBM3	199	400-AL••	61	400-PC••	1037
35••••-10	915	3FF•	198	400-ALT••	119, 1032	400-TCA••	126
35••WF	226	3FF3-S	198	400-AS-AL	64	400-TLT-AL	1031
35••WF2	226	3FM•	199	400AWBPST••	63	400TP	1061
350	162	3FM3-S	199	400AWSP••	63	400YDAAAL	64
350TFXTFAL••••	133	3FS•	200	400-B••	33	401	162
3512	1095	3FS3-S	200	400-B-ALH	33	401-01	354
3533••	65	3-HR1004-3	287	400-C••	6, 35	401-01S	354
3534••	65	3-HR1005	287	400-C••INSERT	35	4020-CVR-AL	120
3543••	65	3JB•	203	400C-90••	59	4020-DA••	53
3544••	65	3JF•	203	400-C-ALH	35	4025-DA••	53
35BTFTXFAL••••	133	3JM•	203	400-C-INSERT••	73	4025REV90SS	841

# Part Number Index

	Page #		Page #		Page #		Page #
4030-A-••	56	40MPF-E•••	677	420TFXTFAL•••••	133	4600300001	821
4030-B-••	56	40MPF-E•••••	677	4215-••	337	4601100418	821
4030-C-••	56	40MPF-SFY••	678	42777••-000•	349	46-030-00025	861, 866, 868
4030-CVR-AL	120, 1033	40MPF-SFY•••	678	42F-••	985	46F-•••	984
4030-D-••	57	40MPF-U••	677	42MP-E••	674, 676	46F-••••	984
4030-DA-••	53	40MPF-U•••••	677	42MP-E••BL	676	4895•••	255
4030-DAVR-AL	120, 1033	40MPF-UW••	677	42MP-G••	675	48F-••	984
4030-DVR-AL	121, 1034	40MPF-UW•••••	677	42MP-GR••	681	48F-•••	984
4030-E-••	57	40MPF-XC••	678	42MP-GRE••	681	48F-••••	984
4030-F-••	57	40MPF-XC•••••	678	42MP-SFY••	675, 676	48P•LJ15	576
4030-MAE	1024	40MPF-XW••	678	42MP-SFY••BL	676	48P•SO15	576
4030-RD-••	1037	40MPF-XW•••••	678	42MP-U••	674	48PFX•••	590
40321TF	122, 1025	40MP-G••	675	42MP-UW••	674	4AGHT4	510
40322TF	122, 1025	40MP-G•••••	675	42MP-UZ••	676	4BF416DITF-CNBR	174
40323BL	122, 1025	40MP-GR••	681	42MP-UZ••BL	676	4BF416DITF-FKM	174
40323TF	122, 1025	40MP-GRE••	681	42MP-UZ••RD	676	4D••-B	198, 199, 201
40364BL	122, 1025	40MPS-E••	679	42MP-XC••	675	4D••-S	198, 199
40364TF	122, 1025	40MP-SFY••	675, 676	42MP-XW••	675	4DB••-B	198, 199
4050-AA-••	55	40MP-SFY••BL	676	42MP-XZ••BL	676	4-DBHU-4	975
4050-DA-••	53	40MP-SFY••RD	676	42MP-XZ••RD	676	4-DCAP	977
4050-DD-••	55	40MPS-SFY••	679	430FXF••00000	130	4-DELU-4	976
4055-3	778, 1068	40MPS-U••	679	430TFTFLAL•••••	133	4-DFC-•	974
4060-A-••	56	40MP-U••	674	430TFXTFAL•••••	133	4-DFE-2	975
4060-AA-••	55	40MP-U••DIN	688	4315-••	337	4-DFPLUG	977
4060-DA-••	53	40MP-U••RJT	688	4316-50	337	4-DMC-•	974
4060-DD-••	55	40MP-U••SMS	688	4328-50	337	4-DME-•	975
4093	1001	40MP-UP••	680	43BTFTFLAL•••••	133	4-DRATT-2	975
40A-45TCAL	126	40MP-UW••	674	43BTFTXTFAL•••••	133	4DS•-B	200
40BS-E••	682	40MP-UZ••	676	43HTFTFLAL•••••	133	4DS•-S	200
40BS-F••	682	40MP-UZ•••••	676	43HTFTXTFAL•••••	133	4-DTMT-4	976
40BS-H••	683	40MP-UZ••••BL	676	440TFXTFAL•••••	133	4-DTTF-4	976
40BS-O••	682	40MP-UZ••••RD	676	44-251-00006	861	4-DTTM-4	976
40BS-S••	683	40MP-UZ••••BL	676	44BTFTXTFAL•••••	133	4-DTTT-4	976
40BS-X••	683	40MP-UZ••••RD	676	44HTFTXTFAL•••••	133	4-DU	975
40BS-Y••	682	40MPV-E••	672	450	162	4-DU-2	975
40IE•••	684	40MPV-G••	671	4500-5	1029	4EA-SKIT	534
40IE•••16	684	40MPV-SFY••	672	4500RK	1029	4FAMT	171
40IH•••	684	40MPV-U••	671	4500RK-V	1029	4FAMTL	171
40IT••	685	40MP-XC••	675	450-4S	282	4FB•	201
40IV••	684	40MP-XW••	675	450TFXTFAL•••••	133	4FBF4	198
40JP-E••	686	40MP-XZ••••RD	676	4510-28	778, 1068	4FBM4	199
40JP-G••	687	40MP-XZ••••BL	676	452••	268	4FF•	198
40JP-SFY••	687	40MP-XZ••••RD	676	4530	1029	4FF4-S	198
40JP-U••	686	40PFX•••	590	4530SG	1029	4FM•	199
40MP-E••	674, 676	40QH••	685	4540	1029	4FM4-S	199
40MP-E•••••	676	40QT••	685	4540DC	1030	4FS•	200
40MP-E••••BL	676	41440-225AL	1029	4540DC-1200	1030	4FS4-S	200
40MP-E••••RD	676	41450-DCAL	1029	4540F	1029	4HF4-HV	484
40MP-E••••BL	676	4-1460-AL	122, 1025	4540SG	1029	4-HR1005	287
40MP-E•••DIN	689	418	162	4540SG-RK•	1029	4HT90F•	507
40MP-E•••RD	676	41FL-•	986	45BTFTXTFAL•••••	133	4HTAG4	510
40MP-E•••RJTCIP	689	41FS-•	986	45CIPUSH	1059	4HTZF•	510
40MP-E•••SMS	689	4201901587	866	45HTFTXTFAL•••••	133	4HTZOF•	510

	Page #		Page #		Page #		Page #
4K•-DP	491			500QCK	415	520••••	355
4KDP	491, 1093			500QCKSS	415	5200-SFI	122, 1025
4K-G-DP	1093	5	478	500QCKV	415	5200-SFI-3	122, 1025
4K-Y-DP	1093	5••	475, 477	500QCM	415, 1078	5200-SFI-3-RK1	123, 1026
4N4N	192	5••••	474	500QCMSS	415	5200-SFI-3V-RK1	123, 1026
4NBF•	190	5••••	335	500QCSG	415	5200-SFI-RK1	123, 1026
4NBF-B	190	5•••••	333, 334, 335, 336, 338	500YC	416	5200-SFIV-RK1	123, 1026
4NBM•	191	5•••LP	286	501••••C	424	5201-SFI	122, 1025
4NBM•-B	191	5••R	475	502••••CLF	424	5201-SFI-RK1	123, 1026
4NF•	190	50-•	68	50212••C	424	5205-RK4	1029
4NF-B	190	500-•	68	50212••SS	424	5404-•	551
4NF-SS	190	500••••	355	5030-DA••	53	5404-••	551
4NF6	1098	5000-•	552	50312••C	424	5404-•••	551
4NF6-S	190	5000-••	552	504-••••	424	5404-••••	551
4NM•	191	5000-•••	552	5040-C-••	56	5406-••	551
4NM•-B	191	5000-••••	552	5040-D-••	57	5406-••••	551
4NM•-SS	191	5000-24	1029	5040-DA••	53	5406-•••••	551
4NM6	1098	5000-24L	1029	5040-E-••	57	5406C-•	555
4NM6-S	191	5000-25	1029	50412••C	424	5406C-••	555
4NS•	191	500-A-••	32	50412••SS	424	5500•	139
4NS-B	191	500-AA-••	55	5060-AA-••	55	5500-•	551
4NS-B-WF	193	500AN•	413, 782	5060-DA••	53	5500••	139
4NS-S	191	500-AN7	413, 782	5061212C	424	5500•••	551
4NS-SS	191	500AWBPST••	63	5061212CLF	424	5500RK•	139
4NS-WF	193	500AWSP••	63	507-••••	423	5500RK••	139
4NS6	1098	500-B-••	33	50712••C	423	5502-•	553
4N-SKIT	1095	500BFP	417	5071208SS	423	5502-••	553
4N-SKIT	192	500-C-••	35	5071212CLF	423	5504-•	553
4P•	577	500-D-••	40	50812••C	423	5504-••	553
4P-CLIP	196	500DA-90••	58	50812••SS	423	5600-•	554
4PF•	194	500-DC-••	47	5081208CLF	423	5600-••	554
4PF-FS	195	500-DD-••	55	509-••••	423	5601-•	554
4PF6	1098	500-DP-••	50	509••12C	423	5601-••	554
4PF6-B	194	500DWBPST••	62	5091212CLF	423	5602-•	554
4PF6-S	194	500DWSP••	62	5091212SS	423	5602-••	554
4PM•	194	500-E-••	43	50-A-••	32	5604-•	554
4PM-FS	195	500-F-••	46	50-B-••	33	5604-••	554
4PM6	1098	500-G-••	69	50-C-••	35	5605-•	554
4PM6-9	194	500GH4VBK	417	50-D-••	40	5605-••	554
4PM6-S	194	500GHV	416	50-DC-••	47	56RBSG-••	238
4PS•	195	500GHY	416	50-DP-••	50	572-••••	441
4PS-B	195	500GTCABF	127	50-E-••	43	572••••C	441
4PS-FS	195	500GTCABU	127	50-F-••	46	574-••••	441
4PS-WF	196	500GTCATF	127	50-G-••	69, 70	574••••C	441
4PS6	1098	500GTCATV	127	50-G-TF-VI	70	575-••••	441
4PS6-9	195	500GTCAVI	127	50-HP-SP	66	575••••K	441
4PS6-S	195	500GTCAVITHK	127	5106	1001	578••••C	419
4PSG	123, 1026	500GTFWB	70	5110-32	778, 1068	585••12C	421
4P-SKIT	196, 1095	500QCF	415, 1078	5111A	435	5851212C	1078
4RKOBV	133	500QCFSS	415	5131212C	422	586••12C	421
4RKOVIVI	133	500QCFV	415	5141212C	423	5861012N	422
4SHD••	207	500QCFVOR	415	5141212CLF	423	587••••K	421
4SHDS•	208	500QCFVSG	415	5141212SS	423		

# Part Number Index

	Page #		Page #		Page #		Page #
588•12C	421	600D-90•	59	62NBH•	235	6501-••••	546
5881212C	1078	600DA-45•	58	62NFBH•	235	6502-•	546
589••••K	421	600DA-90•	58	62NFBH•	235	6502-••	546
59-•••	970	600-D-ALH	40	630•	1021	6503••••WP2	994
59•1616C	374	600-DC-••	47	630•NPT	1021	6505-••	545
590••••C	420	600-DC-ALH	47	6302••••WP2	993	6505-••••	545
590••••CLF	420	600DC-L•	48	6304••••WP2	993	6505-••••	545
590••••SS	420	600-DD-••	55	63046056WP2	993	6505••••WP2	992
591••••C	420	600DD-45•	58	6306••••WP2	993	6506-••	545
591••••N	422	600DD-90•	58	6315••••WP2	992	6506-••••	545
591••••NLF	422	600-DL-••	61	6316••••WP2	993	6506-••••	545
591••••WEPDM	1011	600-DLT-AL	119, 1032	6322••••WP2	995	6508••••WP2	994
591•12CLF	420	600-DP-••	50	6325••••WP2	992	6509••••WP2	994
591•12SS	420	600-DP-ALH	50	6326••••WP2	994	6521••••WP2	994
5911•1•W	412, 1011	600DWBPST•	62	6340••••WP2	993	6530A	1020
5911•1•WEPDM	412	600DWSP•	62	6351••••WP2	994	6530C	1020
5911212F	412	600-E-••	7, 43	6366••••WP2	995	6579••••WP2	992
592••••K	420	600-E-ALH	43	6382••••WP2	995	65NAB•	236
592••••KLF	420	600-F-••	46	6388••••WP2	995	65NAB••	236
592••••KSS	420	600-F-ALH	46	639C-04	982	66•X•	240
593••••C	422	600-G-••	69, 70	63NAB•	238	66•X••	240
593••••CLF	422	600GTF•	70	63NAB••	238	66•X•	240
594••••C	422	600GTHK	69	63PT-••••	982	6600•	547
594••••CLF	422	600-HRP-••	66	6400	1023	6600-••	547
595••••K	422	6030-DA-••	53	6401-••••	541	6602-•	547
5951616K	374	6040-A-••	56	6401-••••	541	6602-••	547
		6040-D-••	57	6401-••••	541	66C-••••	979
		6040-DA-••	53	6403-•	541	66NAB••	234
		6050-DA-••	53	6403-••	541	66NAB•••	234
6	478	60C-••	982	6405-••••	542	66NBH86	235
6••	241, 242, 477	60NAB•	237	6405-••••	542	67RBSG-••	239
6•••	241, 242	60NAB••	237	6405-••••	542	68•X•	240
6••••	939, 940, 941, 943, 944, 970, 971	60PT-••	983	6408HHP•	543	68•X••	240
6••••	334	60RB-••	239	6408HHP••	543	68•X•	240
6•••••	338	61-•••	912	6410-••••	541	68•X••	240
600-•	68	6138	1001	6410-••••	541	6803-•	543
6000-••	1021	61C-••	983	6410-••••	541	6803-••	543
6000-••C	1023	61CL-••	983	6410-40	778, 1068	682C-••••	980
6000-SSA	1021	61NAB•	238	64NAB•	237	688-••	567
600-A-••	32	61NAB••	238	64NAB••	237	68C-••••	978
600-AA-••	55	61RB-••	239	64P•LJ15	576	68CIPUSH	1059
600-A-ALH	32	61RBSG-••	238	64P•SO15	576	68NAB••••VS	234
600-AL-••	61	62-•••	912	64PFX••••	590	68NAB••••VS	234
600-ALT-••	119	6200	1020	650-S	282	68NAB••VS	234
600-ALT-AL	1032	6200•	1020	6500	1020	68RB-••••B	239
600AWBPST•	63	6200••	1020	6500-•	545	68RBSG-••••	239
600AWSP••	63	62C-••	979	6500-••	545	69•X•	241
600-B-••	33	62C-••••	979	6500-••••	545	69•X••	241
600-B-ALH	33	62CBH-••	979	6500-••••	545	69•X•	241
600-C-••	6, 35	62NAB•	235	6500-••••	545	69•X••	241
600C-90•	59	62NAB••	235	6500A	1020	6901-••••	542
600-C-ALH	35	62NABH•	235	6501-••••	546	6901-••••	542
600-D-••	40	62NBH•	235	6501-••••	546	6901-••••	542



# Part Number Index

	Page #		Page #		Page #		Page #
A9	1096	A515-75...	752	ADPW	915	AM7	1096
A21-24	146	A515R50...	753	ADS400	64	AM7T	184
A21-24	146	A515Y50...	753	ADS-GR	149	AM8	1096
A21-120	146	A525-25...	752	ADS-GR	149	AM11WF-1	184
A21-120	146	A525-50...	752	ADS-GR-IB	149	A-M-B	212
A-50RAF	751	A525-75...	752	ADS-GR-IB	149	AMB1	180
A-50RAS	751	A540CSB0251	148	ADV150F	871	AMC1	180
A-50RBF	751	A8000G	149	A-F	212	AMF	266
A80MP-SFY	680	A8000GJ	149	A-F-B	212	AM-SWIV	184
A80MP-U	680	A5150R50...	753	AFC-F-TGWP	820	AM-WF	184
A100C-A	145	A510100...	752	AFN	788	AM-WF	184
A100CA1050	150	A515100...	752	AFN-NST	788	ANH	187
A100CA1050V	150	A525100...	752	AG	957	ANH	187
A100CBLMTR	150	AAPN75GHT	414	AG3F3-PV	1092	ANSI	964
A100CSS-A	145	AB	180	AG-BF	493	ANT	791
A100D	150	AB	180	AG-BF-PV	493	ANT-F	791
A100HC-A	145	AB	34	AG-DC	493	APN	951
A100LT	150	ABB1	180	AGE-F-PV	493	APRD-F	868
A100MTR	150	ABC	419	AGE-OF-PV	493	AQ62DOT	228
A-100RAF	751	ABC1	180	AG-F	493, 1091, 1092	AQ64DOT	229
A-100RAS	751	ABC250	819	AG-F-PV	493, 1092	AQ68DOT-X	228
A-100RBF	751	AB-EZ	34	AG-OF	493, 1092	AQ69DOTS-X	228
A100SG-POLY	150	ABH	769	AG-OF-PV	493	AQ69DOT-X	228
A100TT	150	ABH-F	769	AH	48	AQ71DOTS-X	229
A200CA3P	149	ABN100	789	AHA-ADP	64, 814	AQ72DOTS-X	229
A200CA5P	149	ABN150	789	AHA-BSP-T	925	AR3000-A2	405
A200CB3P25	149	AC	36	AHDBF75	915	AR3500	408
A200PC-A	147	AC1	186, 1095	AH-EZ	49	AR5000-1	409
A200PHC-A	147	AC7	73	AHGV250	859	AR20831	409
A200SA	150	AC200TUBE	65	AHGV250F	859	AR503830SSP	409
A200SVA	150	ACB304	386	AHGV250F-	859	AR-BROOM16	408
A210-120TC	150	AC-EZ	38	AHW	828	AREP400AS	848
A210CR	150	AC-EZSWIV	25	AHWPT	829	AR-REEL100	409
A210PZH-24	150	ACL	74	AK3526-300FL	785	ARMSA-F	809
A240	148	ACL8	186, 1095	AK4450NST	785	ARMSA-F-T	809
A269.065-G400U	694	ACPSO150	789	AKSP1	186	ARTEL18A	404
A269.083-G-U	694	ACPSO150F	789	AKSP25	186	ARTEL-BELT	404
A269.083-R400U	694	AD	41	AL	403, 404, 405, 408, 409	A-S	212
A269.109-G600U	694	AD400ALEZMTC	125	AL9	402	A-S-B	212
A269.109-R600U	694	AD90400	59	AL455F	405	ASB	187
A269-G-U	694	ADA	54	ALBEZ	24	ASB	187
A269-R-U	694	ADA-EZ	54	ALC-EZ	29, 176	ASBDV	864
A270.065-G-P	694	ADD	55	ALCEZ	24	ASC	187
A270.083-R400P	694	ADD	55	ALDEZ	24	ASHV1015F	871
A270.109-R600P	694	AD-EZ	42	ALH-EZ	30	ASP310-40	269
A270-G-P	694	AD-EZSWIV	25	ALHEZ	24	ASP310-90	269
A270-PM	695	ADH45F-F	834	ALTG-F	1062	ASP-BV	271
A270-R-P	694	ADH45M-F	834	AL-TPR	408	AST	358
A270-R-P	694	ADH90F-F	834	AL-XX	403	AST	358
A270-R-PL	695	ADH90M-F	834	A-M	212	ASTB	359
A510-50	752	ADHC-F	834	AM	180, 181, 264	ASTB	359
A515-25	752	ADHP-F	834	AM	180, 181	AT1350	138
A515-50	752	ADLTVR400EZ	121	AM6	1096	ATC40ASSAPI	126



	Page #		Page #		Page #		Page #
ATC40ASSDDA	126	B2CMP-G***	602	B2WK-G***P	615	B08-02MGMB	290
ATCA40	124	B2CMP-G****	602	B2WK-G***P	615	B9MP-G***	612
ATCF40	124	B2CMPL-R**	602	B2WK-G***U	625	B9MP-R***	612
ATCF40-90	124	B2CMP-R**	602	B2WK-G***U	625	B9WWWW-G***P	623
ATCG40-90	124	B2CMP-R***	602	B2WK-R***P	615	B9WWWW-R***P	623
ATCGF40	124	B2CM-R**	616	B2WK-R***P	615	B14C31-G*****	605
ATCS40	124	B2CM-R***	616	B2WK-R**P	615	B16W-G***	621
ATCT**	125	B2E-G***	634	B2WK-R***U	625	B16W-R**	621
ATN100X7	133	B2EI-G***	640	B2WK-R***U	625	B16W-R***	621
ATS7838F	227	B2F-G***	634	B2WK-R**U	625	B17-08AGMB	328
ATS7838M	227	B2FI-G***	640	B2WUL-R***P	623	B17-08MGMB	328
ATS***H	227	B2FMP-14-G***	602	B2WUL-R***U	628	B18**AG	302
ATTFST40CS	10	B2FP-G***	616	B2WUMP-R***	612	B18**AGMB	302
AV***	852, 855	B2KM-G***	616	B6-1	157	B18**MG	302
AV***-	852	B2KMP-G***	602	B07-202*GC	317	B18**MGMB	302
AV5-250F	853	B2KMP-G****	602	B07***AG	318	B19MPV-R***	666
AV5-250NYFD	853	B2KMP-R**	602	B07***MG	318	B19MPX-R***	666
AV250NYFD	852	B2KMP-R***	602	B7MMW-G***	619	B19WB-G***	622
AV250NYFD-I	854	B2KM-R***	616	B7MP-G***	604	B19WB-R**	622
AV251-N	855	B2KS-G***P	615	B7MP-G****	604	B19WB-R***	622
AV251NYC	855	B2KS-G***U	625	B7MP-R**	604	B19WV-R***	666
AV251NYFD	855	B2KS-R***P	615	B7MP-R***	604	B19WX-R***	666
AVAPR***F	869	B2KS-R**P	615	B7MPS-G***	604	B22WB-G***	622
AVAPRF***	869	B2KS-R***U	625	B7MPS-R**	604	B22WB-R**	622
AVAPR***F-I	869	B2KS-R**U	625	B7RMP-G*****	604	B22WB-R***	622
AVAPRF***-I	869	B2P-G100	634	B7RMP-R*****	604	B23BMP-G***	607
A*VC*MG	997	B2SC	156	B7RMP-R*****	604	B23BMP-G****	607
AVF***	776, 852, 855	B2S-G***P	615	B7RMP-R7550	604	B23BMP-G*****	607
AVF5-250	853	B2S-G**P	615	B7RWWW-G*****P	618	B23BMP-R***	607
AVF***-I	854	B2S-G***U	625	B7RWWW-G*****U	626	B23BMP-R****	607
AVG250*	853	B2S-R***P	615	B7RWWW-R*****P	618	B23BMP-R*****	607
AVGF250	853	B2S-R**P	615	B7RWWW-R*****P	618	B24-BM-G***	702
AV***-I	854	B2S-R***U	625	B7RWWW-R***P	618	B24-BMR6-G***	702
AVN****-200	966	B2S-R**U	625	B7RWWW-R*****U	626	B24-BMTC-G**	702
AV***-RBR	852, 855	B2SXL12-R**	617	B7RWWW-R*****U	626	B24-HP-G***	701
AV***S	852	B2SXL18-R**	617	B7W-G***P	618	B24HS-G**	699
AV***-W	866	B2SXL24-R**	617	B7W-G***U	626	B24HS-G***	699
AV***-WR	855	B2SXL36-R**	617	B7WMM-G***	619	B24-PHC-G***	703
AWR4	186, 1095	B2SXLMP12-R**	603	B7W-R***P	618	B24-PHCL-G***	703
AWR14	186	B2SXLMP18-R**	603	B7W-R**P	618	B24-PHC-PHCL	703
AWS6	186	B2SXLMP24-R**	603	B7W-R***U	626	B24-PH-G***	703
AWSG	396	B2SXLMP36-R**	603	B7W-R**U	626	B24-PHL-G***	703
AWSG-TG	395	B2T-G***	616	B7WWM-G***	619	B24-PHR6-G***	703
AWSG-W	396	B2WCL-G***P	615	B7WWM-R**	619	B24-PHR6L-G***	703
		B2WCL-G***P	615	B7WWM-R***	619	B24-PHRL-G075	703
		B2WCL-G***U	625	B7WWW-G*****P	618	B24-PHRL-PHR6L	703
B*	154, 157, 161	B2WCL-G***U	625	B7WWW-G***U	626	B24PS-G**	699
B**	154, 157, 161, 162	B2WCL-R***P	615	B7WWW-R*****P	618	B24PS-G***	699
B2C-G***	634	B2WCL-R***P	615	B7WWW-R***P	618	B24PS-G****	699
B2CI-G***	640	B2WCL-R**P	615	B7WWW-R***U	626	B24PV-G**	667
B2CM31MPG*****	602	B2WCL-R***U	625	B08-02AG	290	B24PV-G***	667
B2CM31MPR*****	602	B2WCL-R**U	625	B08-02AGMB	290	B24RGC13-G**	697
B2CM-G***	616	B2WCL-R**U	625	B08-02MG	290	B24RGC13-G***	697

# Part Number Index

	Page #		Page #		Page #		Page #
B24RGC-G••	697	B31W-R••••U	627	B3214MP-R••••	606	BB3-0•MGMB	289
B24RGC-G•••	697	B32W-G•••••P	621	B3214MP-R•••••	606	BB••EZ	34
B24RG-G••	696	B32W-G•••••U	627	B3214MP-R••••••	606	BBFVW•••	903
B24RG-G•••	696	B32W-R•••••P	621	B3401-•••	556	BBFVW•••E	903
B24RG-G••••	696	B32W-R•••••P	621	B3401-•••••	556	BBLV••	264, 876
B24RGSFY-G••	696	B32W-R•••••P	621	B3455-•••	556	BBLV•••	876
B24RGSFY-G•••	696	B32W-R•••••U	627	B3455-•••••	556	BBN75	779
B24RGSFY-G••••	696	B32W-R•••••U	627	B3800-•••	556	BBN75GHT	779
B24RPH-G••	700	B32W-R•••••U	627	B3800-•••••	556	BBN100	779
B24RPH-G•••	700	B38MP-R•••	613	B3801-•••	556	BBN100NST	779
B24RV-G••	667	B38SL-G•••	624	B3801-•••••	556	BBU•	161
B24RV-G•••	667	B38SL-G••••	624	B5101E•••CC-A	738	BBU••	161
B24V-BM-G••	669	B38SL-R•••	624	B5101E•••CC-B	739	BBV••	875
B24V-BMR6-G••	669	B38SL-R••••	624	B5101E•••CC-C	740	BBV•••	875
B24V-PHC-G••	670	B38W-R•••	624	B5101-RKE•••	740	BBV75FP	875
B24V-PHCL-G••	670	B38W-R••••	624	B5101-RKS•••	740	BBV75LV	1101
B24V-PH-G••	670	B45AB-R•••	745	B5101-RKV•••	740	BBV••DTW	881
B24V-PHL-G••	670	B45AB-R100150	745	B5101S•••CC-A	738	BBV••DTW	881
B24V-PHR6-G••	670	B45BC-R•••	745	B5101S•••CC-B	739	BBV••DW	880
B24V-PHR6L-G••	670	B45BC-R100150	745	B5101S•••CC-C	740	BBV••DWV	880
B24V-TM-G••	668	B45BY-RK•••	744	B5101V•••CC-A	738	BBV••FP	875
B24V-WP-G••	668	B45BY-SK•••	744	B5101V•••CC-B	739	BBV••LV	877
B24-WP-G••	701	B45BY-SKV•••	744	B5101V•••CC-C	740	BBV••LV	877
B25-G•••••	704	B45BY-TB•••	744	B5102E••••A	741	BBV••SR	876
B25-G••••••	704	B45CC-R•••	745	B5102-RKE•••	741	BBV••SR	876
B25-G•••••••	704	B45CC-R100150	745	B5102-RKS•••	741	BBV••ST	877
B28-••AG	303	B54BMPLX-R•••	724	B5102-RKV•••	741	BBV••ST	877
B28-••AGMB	303	B54BMP-R•••	723	B5102S••••A	741	BBV••TW	881
B28AMP-R••	612	B54BMP-R•••X	723	B5102V••••A	741	BBV••TW	881
B28BMP-R••	612	B54BMPS-GL•••	724	B5107-RKE800	740	BBV••VT	877
B28-••MG	303	B54BMP-SK•••	723, 724	B5115-RKS•••	742	BBV••VT	877
B28-••MGMB	303	B54BMPS-LX•••	724	B5115S•••BB-C	742	BC••	420
B28WA-R•••P	623	B54BMPS-R•••	724	B5115S•••CC-C	742	BC••	36
B28WA-R•••U	628	B54BMP-VK•••	724	B5416MP-A•••	723	BC61-•••	96, 1039
B28W-R•••U	628	B54G-P•••	723	B5416MP-A100150	723	BC62-•••	96, 1039
B31M-G•••••	620	B72G-•AG	326	BA••	423	BCC••	613
B31M-R••••	620	B72G-•AG-MB	326	BA•••	423, 424	BCCR•••	613
B31M-R•••••	620	B72G-•MG	326	BA31-•••	97, 1040	BC••EZ	38
B31M-R••••••	620	B72G-•MG-MB	326	BA32-•••	97, 1040	BCF••	420
B31RMP-G•••••	600	B73G-•AG	327	BA61-•••	97, 1040	BC••K1-200	96, 1039
B31TP-G•••••	635	B73G-•AG-MB	327	BA62-•••	97, 1040	BCM••	420
B31TT-G•••••	635	B73G-•MG	327	BA97•	424	BCN••	451, 928
B31W-G••••••P	620	B73G-•MG-MB	327	BA776	423	BCN•••	451, 928
B31W-G••••••P	620	B74G-•AG	327	BAC-•••	97, 1040	BCP-•••	97, 1040
B31W-G••••••U	627	B74G-•AG-MB	327	BA•F•F	449, 922	BCV••	276, 912
B31WMP-G•••••	600	B74G-•MG	327	BA••K1-•••	97, 1040	BCW-•••	624, 628
B31WMP-R•••••	600	B74G-•MG-MB	327	BAS97•	424	BD	161
B31W-R••••••P	620	B3114MP-G•••••	605	BB•	161	BD••	41
B31W-R••••••P	620	B3114MP-R••••	605	BB••	154	BD••EZ	42
B31W-R••••••P	620	B3114MP-R•••••	605	BB•••	34	BDS••	556
B31W-R•••••P	620	B3114MP-R••••••	605	BB3-0•AG	289	BEC••	966
B31W-R••••••U	627	B3115F-G•••••	635	BB3-0•AGMB	289	BECC••	966
B31W-R••••••U	627	B3214MP-G•••••	606	BB3-0•MG	289	BF••	427

	Page #		Page #		Page #		Page #
BF...	427, 433	BIT-KIT	402	BR1GM•B-E-7	211	BTG-KIT	1057
BF...	433	BL...	1041	BR1M•B-E-7	211	BTN75	413, 782
BF30•••••	733	BLCA152CS	73	BR1S••B-E-7	211	BU•	161
BF302•••••	733	BL••NS	1041	BR•••B	920	BU••	161, 162
BFAR...	955	BL-RK•	1041	BR•••FS	920	BU29	1097
BFAR•••	955	BL-RK••	1041	BR•••G	919	BV2•	274, 908
BFC...	276, 904	BL-RK•••	1041	BRN150	781	BV2CV•••CC-A	736
BFC•••	276, 904	BLS••	374	BRN150NST	781	BV2GG•••CC-A	737
BFL••	433	BLS•••	374, 422	BRN150NST-I	781	BV2IGN•••11-A	884
BFM•••B	433	BLS8•8	374	BRN150S-I	781	BV2IGN•••33-A	884
BFMW•••	433	BLS•••NST	375	BR•••SS	920	BVDSO••	790
BFN...	780	BLS••NST	375	BS••	162	BVDSO150NST	790
BFN75	780	BLT••••	968	BS•••••••	734	BVFS••	914
BFN75GHT	780	BM•	368, 428	BS•••	371, 373	BVSO••	790
BFNE150	780	BM••	368, 428	BS•••••••	734	BVSO150-125	790
BFNE150NST	780	BM••	368, 428	BS•••••••	734	BVSO150NST-125	790
BFN•••NST	777, 780	BMA••	424	BS8•8	373	BVSO•••NST	790
BFO...	458	BMAS••	395	BS61•••	96, 1039	BVTSO150	790
BFP200	870	BMS•	159	BS62•••	96, 1039	BVTSO150-200	790
BFS••	428	BMS••	159	BS808	420	BVTSO150NST-200	790
BFS•••	428	BMV••	876	BS818	420	BVTSO•••NST	790
BFSE••	955	BMV100	876	BS848	420	BWSG	396
BF••SS	427	BN•	414, 782	BSA••	395	BWSG-TI	398
BFVL•••	903	BN••	426, 782	BSB••	1013	BWSG-W	396
BFVL•••E	903	BN•••	276, 426, 905	BSB••••	1013	BZ4051	1028
BFVW••	903	BN••••	276, 905	BSB•••••	1013	BZ4051S	1028
BFW••	433	BN••BSPT	427	BSB••	187		
BFW••••	433	BN••F	782	BSB•••	187		
BGB•	153, 154	BNH••	187	BSB-20Z	1013	C••	959
BGB••	153, 154	BNH•••	187	BSB••T	1013	C•••	959
BGE••	279	BN••NYFD	782	BSB•••T•••	1013	C03-0•A	291
BGE6	279	BN•••RU••	446	B••SC	156, 264	C03-0•AMB	291
BGF••	153	BN••RU••	446	BSC••	187	C03-0•M	291
BGH••	421	BN•••RU••SS	446	BSCCQ3-R••	732	C03-0•MMB	291
BGHF••	421	BN••RU••SS	446	BSCCQ4-R••	732	C6•••SFKIT	566
BGHM••	421	BNS••	395	BSCCQ•-R••	732	C08-02A	291
BGV••	900	BNS••SS	395	BSCCS•-R••	732	C08-02AMB	291
BGV•••	900	BNT••F	782	BSM••	452, 929	C08-02M	291
BH••	48	BOC-T••	1016	BS••N	371	C08-02MMB	291
BH6	66	BP40•••	946	BSO150-H	782	C16••A	306
BH••EZ	49	BP40•••T•••	946	BSO150NST	782	C16••AMB	306
BHSC34	66	BP80•••	946	BSO150S	782	C16••M	306
BHSC152	66	BP80•••T•••	946	BSS61•••	96, 1039	C16••MMB	306
BHSC175	66	BPF••	439	BSS62•••	96, 1039	C18••A	307
BHT••••	935	BPF•••	439	BSS••K1•••	96, 1039	C18••AMB	307
BIA250•	849	BPFS••	440	BST•	358	C18••M	307
BIB250•	849	BPM•	440	BST••	358	C18••MMB	307
BIC••	850	BPM••	440	BSVD-HC••B••	749	C26••A	307
BID250•	849	BPN••	438	BSVS-HC••B••	749	C26••AMB	307
BIDC250	850	BPN•••	438	BTB-T••	1016	C26••M	307
BIDP250	850	BR••••	919, 1000	BTB-T••Z	1016	C26••MMB	307
BIE••	850	BR1BF•-B-E-7	211	BTG-G50	1057	C28••A	308
BIF250•	849	BR1F•-B-E-7	211	BTG-HANDLE	1057	C28••AMB	308

# Part Number Index

	Page #		Page #		Page #		Page #
C28**M	308	CD	161, 185	CM*F	535	CVV*DC	530
C28**MMB	308	CDMHCB****	843	CMF**	271	CVV*DC	530
C31-08FRAME	310	CF400**CSHD	12, 173	CM*F-B	535	CVV*F**	529
C31**A	308	CF400*CSHD	12, 173	CM*M-B	535	CVV*F*	529
C31**AMB	308	CFB75GHT	787	CM*M-B-L*	535	CVV*FM****	529
C31**M	308	CFB**NST	787	CM*M-B-L*.*	535	CVV*OF*	529
C31**MMB	308	CFB****S	787	CN	113	CWG-C*.*****	1018, 1070
C119**AMB	343	CFB**S	787	CN**	928	CWG-S*.*****	1018, 1070
C119**MMB	343	CF****CS	13, 14	CN**B	450, 927	CWH50	410
C614K***PSW	565	CF****CS	13, 14	CNB75GHT	414		
C6100F****	566	CFFR150	788	CNB75GHT-GD	414	D**	264, 274, 908, 916
C6143K***NPT	564	CFFR150NST	788	CN**G	928	D**	284, 768
C6145F****	566	CFG**NST	787	CN-P	113	D****	766, 768
C6146K***SAE	564	CFG**S	787	CN-PLUG	113	D2**	201
C6161***PSW	565	CFR**	773	CN**SS	928	D2B2-B	201
C6190F****	566	CFR47-1-***	773	CPV**F	870	D2C****	95
C6200F****	566	CFR47-150-***	773	CR	464	D-4HF4-S-FNS	484
C6244K***NPT	564	CFR47-C*	773	CR-C	113	D-4HF4-S-FSB	484
C6245F****	566	CFS800*CS	11, 166	CR-CAP	113	D-4HF4-SS-FNS	484
C6245***NPT	564	CF****SS	13, 14	CR-S	113	D-4HF4-SS-FSB	484
C6248K***SAE	564	CF****SS	13, 14	CRWC	464, 1081	D18-04M	309
C6249***SAE	564	CG**	472	CS**	472	D18-04MMB	309
C6259K***PSW	565	CGN**NST	784	CS****AL	15, 16	D28**MMB	309
C6260***PSW	565	CGSN**F	784	CS****AL	15, 16	D34**	266
C6290F****	566	CGSN**S	784	CSB**	371	D75AL	916
C32112M	287	CH-B*	73	CS****CS	15, 16	D150SDB	397
C33112L	287	CH-B**	73	CS***CS	15, 16, 364	D150S-WAND	397
C61104***NPT	564	CH-C**	73	CSC-T*-1	1017	D201	279
C61106***SAE	564	CH-SS*	73	CSC-T*-2	1017	D201RT	278
CAB**	370	CH-SS**	73	CSCTF25F30T*	845	D204-30	277
CAB**N	371	CI9	1059	CSCTM25F30T*	845	D204-30P	277
CAL**	74	CI96	1059	CSES150F	832	D204-30SB	277
CAMOPENER	28	CI96AH	1059	CSES150T	832	D263	766
CAP**FABS	817	CI9311SML	1059	CSES2015F	832	D263F	766
CAP**F-C	817	CILR**	592	CSM**	371	D605	279
CAP**F-C-LH	817	CILR**OCS	591	CSN75	413	D815-25**	753
CAP**SABS	817	CILR**CS	11	CSS****CS	364	D815-50**	753
CAP**S-C	817	CJ2BF-LG	206	CSS****CS	364	D815Y50**	753
CB	154	CJ2F-LG	206	CSSF150T	772	D815Y100**	753
CB6**AG	302	CJ2M2-B	280	CSSR**	592	D817Y50RAF	753
CB6**AGMB	302	CJ3BF*	206	CSSR**3A	592	D825-25**	753
CB6**MG	302	CJ3BM*	206	CSSR**CS	11, 591	D825-50**	753
CB6**MGMB	302	CJ3F*	206	CS****SS	15, 16	D825Y50RAF	753
CBB**	370	CJ3M*	206	CS****SS	15, 16	D825Y100RAF	753
CBC**	419	CJ*BF-B	206	CSSTF**F*T*	844	D8325Y50RAF	753
CBG25	283	CJ*BM-B	206	CSSTM**30T*	844	D11023BL*	793
CBSR**	592	CJ*BM-LG	206	CTER**	592	D156020*	793
C**BU	959	CJ*F-B	206	CT**L	463	D815100**	753
C**BU	959	CJ*M-B	206	C**V	959	D825100**	753
CC	157	CJ*M-LG	206	CV**	913	DAA**AL	104
CC****	282	CL****	999	CVS**	73	DAA**ALFL	104
CC****B	282	CL******	999	CVV**BF**	529	DAB*	1045
CCF****	185	CM3M2-B-L11.5	535	CVV*BF*	529		

	Page #		Page #		Page #		Page #
DAB••	1045	DCP•SWIV	214	DFN100F-NC	1048	DL••••	462
DAC••••	1045	DCS4025F••	839	DFN100F-NPNF	1048	DLB12	163
DAC•••AL	103	DCS4030NYFD	839	DFN100-NC	1047	DLS••••	462
DAC•••ALBSP	103	DCS6030GSS	841	DFN100••-NC	1046	D•M•	197, 1086
DADC250	104	DC•••SE	219	DFN100-NPNF	1047	DM•	367
DADP250	103	DC••SE	219	DFN100••-NPNF	1046	DM••	367
DATL•••	267	DC•SE	219	DFP••••	797	DM•••	367
DATL016	1100	DCS•••F	839	DF-PES. ••••S	729	DM••50GAX	762
DATL016W	1100	DCS•••F••	839	DFP••••F	797	DM••100GAX	762
DATL•••W	267, 1100	DD	161	DFP••••F-D	797	DM150SDB	397
DAWS••	1045	DDA•••••105	100	DFP•••F••S	797	D•M•-B	197
D•B•	201	DDA•••••105FL	100	DF-PHB••••S	730	DMH••••	811
DB•	158	DDA•••AL	100	DF-PHB•••••S	730	DMH20DR20	916
DB••	158	DDA•••ALFL	100	DF-PHB. •••••S	730	DMH••••D	813
DB11023•	793	DDA•••AL••TTMA	100	DFP••NYFD••NYFD	797	DMH••••F	811
DBA•••••	94	DDA•••BR	100	DFR••••	797	DMH••••F-D	813
DBA•••1520	94	DDA•••BRFL	100	DFR••••F	797	DMH••F••F	811
DBAF•••••	94	DDA•••SS	100	D•F•-S	197	DMH••F••F-D	813
DBAF•••••	94	DDA•••SSFL	100	DFVS••	391	DMH••F••NYFD	812
DBAV73-2030	95	DDC•••••105	99	DG•••	354	DMH••F••S	811
DBC•••••	93	DDC400AL164TTMA	99	DG••••	354	DMH••F••S-D	813
DBC62LVPR-300	121	DDC•••AL	99	DG•••••	354	DMH••••NYFD	812
DBC•••••GL	93	DDC•••BR	99	DGA•••SS	102	DMH••NYFD••NYFD	812
DBCL•••	93	DDC•••SS	99	DGA•••SS••	102	DMH••S••S	811
DBD550•	793	DDC•••SSFL	99	DGA•••SSFL	102	DMH••T••T	811
DBD1560•	793	DDDC•••	100	DGC•••SS	102	DMOCA••225F	847
D•BF•	197	DDDC300105	100	DGDC•••	102	DMP••••	813
DBGV••	900	DDDP•••	99	DGDP•••	102	DMP••••F	813
DBGV•••	900	DDDP300105	99	DGH7	415	DMP••F••S	813
D•BM•	197	DDEA•••SS	108	DGH7C	415	DMP••F••T	813
DBS•••••	93	DDEA•••SSFL	108	DGH7CSS	415	DMP••S••T	813
DBV-BL••	962	DDEC•••SS	108	DGH7CV	415	DMR••••	813
DBV-BN••	962	DDEC•••SSFL	108	DGH7P	415	DM••••RAF	762
DBV-VB••	962	DDSA•••SS	101	DGH7PSS	415	DM•••••RAF	762
DBV-WB••	962	DDSC•••SS	101	DGH7SS	415	DM••••RAS	762
DC•	217, 222	DDT1	1064	DGH7V	415	DM•••••RAS	762
DC••	217, 224, 225	DEFN075	1049	DGHW7	415	DM••••RAT	762
DC•••	217, 222	D••••F	766, 768	DGLBV••	901	DM•••••RAT	762
DC••••	217, 218, 224	D•••F	768	DGLBV•••	901	DMR••••F	813
DCG2510•	794	D•F•	197, 1086	D-H4F4-S	484	DMR••F••S	813
DCG8020•	794	DF16•••	830	D-H4F4-SS	484	DMR••F••T	813
DC••••L	217, 224	D•F•-B	197	D-H4F4-SV-8	484	DMR••S••T	813
DC•••L	222	DF-MBS••••	728	DHR1	1059	D•M•-S	197
DCL••	1063	DF-MBS•••••	728	DHR2	1059	DM•••••UC	762
DC•••LSE	219	DF-MBS•••••	728	DHS•••••	1069	DM••••UC	762
DCM1	1064	DFC•	977	DHS90•••	1069	DMXL••	367
DCP•	221	DFC••	977	DHS•BF	834	DN•	977
DCP••	215, 223, 225	DF-CB•••••B	731	DHSSC6	834	DN••	977
DCP•••	221	DF-CB•••••B	731	DIN-SMS-60/90SP	647	DN7•OBF	1048
DCP••••	215, 216, 223	DFD-10	273	DIN-SMS90/155SP	647	DN7U•BF-NC	1048
DCP••••L	216, 223	DFG•	284	DKC1	272	DN7U•BF-NPNF	1048
DCP•••L	221	DFN•••	1047	DL••	477, 567	DNOG•	1049
DCP••SWIV	214	DFN100•F	1046	DL•••	477	DNOG5-NL	1049

# Part Number Index

	Page #		Page #		Page #		Page #
DP2-01-***	313	DWG050	398	ENBG1	278	F18-C00•	321
DPW	915	DWL100	1065	ENBL	113	F18-••M	292
D••R	285	DX•••	773	ENBL-P	113, 117	F18-••MMB	292
DRC-•	977	DX603010A1GV1	735	ENBL-P•	117	F23-04M	310
DRC-••	977	DX603010A1GV2	735	ENBL-PLUG	113	F26-••A	292
DRK15	1064	DXHDR25HC	771	ER••••	767, 768	F26-••AMB	292
DRP-85-059	312	DXHDR25PB	771	ER•••••	767, 768	F26-••M	292
D••S	285	DXHDRC25HC	771	ERJ	113	F26-••MMB	292
D•S•	198			ERJ-C	113	F28-••A	293
D•S•-B	198			ERS	113	F28-••AMB	293
DSB••	390	E73•A	332	ERS-C	113, 117	F28-••M	293
DSBV••	882	E73•A-MB	332	ERS-C•	117	F28-••MMB	293
DSBV•••	882	E73•M	332	ERS-CAP	113	F30••A	293
D••SC	916	E73•M-MB	332	E•S•	401, 533	F30••AMB	293
DSCV••	914	E74•A	332	E•S•-B	401, 533	F30••M	293
DSCV•••	914	E74•A-MB	332	ESB-CLAMP••	137	F30••MMB	293
DSG540•	794	E74•M	332	ETP	1060	F35-0•AMB	293
DSG1560•	794	E74•M-MB	332	EZL••0-B••	27	F35-0•MMB	293
DSG3012•	794	EA•F•	534	EZL••0-C••	27	F72G•A	319
D•S•-S	198	E•BF•-B	400, 532	EZL••0-D••	27	F72G•A-MB	319
DST••	390	EC••	966	EZL••0-DC••	28	F72G•M	319
DSTW	1065	E•F••	400, 532	EZL••0-G••	28	F72G•M-MB	319
DTW•••	767, 768	E•F•	400, 532	EZL•00RPLKIT	28	F73G•A	320
D••U	285	E•F••-B	400, 532	EZLCL400	28	F73G•A-MB	320
DVB1560•	793	E•F•-B	400, 532			F73G•M	320
DVB3012•	793	E•F••-S	400, 532			F73G•M-MB	320
DVF-A••GA	712	E•F•-S	400, 532	F•	469, 473	F74C•A-MB	321
DVF-A••GB	713	EHSCE•••	743	F••	469, 473	F74G•A	320
DVF-A••GC	713	EHSCV•••	743	F•••	578	F74G•A-MB	320
DVF-A••GD	713	EK602•	343	F••••	469, 473, 474	F74G•M	320
DVF-A••GE	713	EK602VB	343	F•••••	578	F74G•M-MB	320
DVF-A••••GF	714	EL••••••	384	F03-0•A	288	F74H•A-MB	321
DVF-A••GF	714	EL•••••••	380, 384	F03-0•AMB	288	F74V•A-MB	322
DVF-A••GG	714	EL45••	933	F03-0•M	288	F602••WJ	339
DVF-A••••LH	714	EL45•••	933	F03-0•MMB	288	F602••WJR	339
DVF-A••LH	714	EL90••	930	F-4EA-SKIT	534	FA••	964
DVF-B•••GA	715	EL90•••	930	F-4N-SKIT	192	FAB•••	370
DVF-B••GA	715	EL90•••B	930	F-4P-SKIT	196	FAB•••N	371
DVF-B•••GB	716	EL90•••FS	930	F07-200•C	317	FAPRAV250F	868
DVF-B••GB	716	EL90••FS	930	F07-•••A	318	FAPRAVF250	868
DVF-B•••GE	716	EL90•••G	930	F07-•••M	318	FAPRAVG250•	868
DVF-B••GE	716	EL90••G	930	F08-02A	288	FAPRV•250	868
DVF-B•••GG	716	EL90•••SS	930	F08-02AMB	288	FBB•••	370
DVF-B••GG	716	EL90••SS	930	F08-02M	288	FBSO•••F	791
DVF-B•••••LH	716	EL•F•F	452, 930	F08-02MMB	288	FBSO•••F-PG	791
DVF-B•••••LH	716	EL•H•M	429	F16••A	292	FBSO•••S	791
DVF-C•••G1Q	717	EL•H•M	429	F16••AMB	292	FBSO•••S-PG	791
DVF-C•••G1R	718	EL•H•MSS	429	F16••M	292	FBV••	878
DVF-C•••G1S	718	E•M••	400, 532	F16••MMB	292	FBV•••	878
DVF-C•••G1T	718	E•M•	400, 532	F17-•••A	321	FBVG••	879
DVF-C•••••G1U	719	E•M••-B	400, 532	F17-•••M	321	FBVG•••	879
DVF-C•••G1V	719	E•M•-B	400, 532	F18••A	292	FBVL••	878
DVF-C•••••G1W	719	E•M•-S	400, 532	F18••AMB	292	FBVL•••	878

	Page #		Page #		Page #		Page #
FBV•••SE	879	FJB-20Z-20	1014	FM••F••F-D	803	FOS••	469
FBV••SE	879	FJC•••••	1014	FM••F••NYC	805	FOS•••	469
FC•••	816	FJC-20Z-20	1014	FM••F••NYFD	805	FP•••	821
FC•••••	382, 384	FJC45•••••	1015	FM••F••S	804, 805	FP•••••	386
FC•••••	378, 382, 384	FJC45-20Z-20	1015	FM••F••S-D	803	FP•••••	380, 386
FC31012-PC	388	FJC90•••••	1015	FM••F••T	804, 805	FP475S	785
FCB48	777	FJC90-20Z-20	1015	FM••F••T-D	803	FP500•	785
FC•••F	816	FJC-T••	1016	FMGR••F••F	872	FP•••F	821
FC•••F•	816	FJR-T••	1016	FMI•••••	385	FP•••F•	821
FC•••F-D	819	FJS•••••	1014	FMI•••••	385	FP•••F-D	821
FCM•••••	382	FJS-20Z-20	1014	FMI•••••	385	FR3C•••••	837
FC•••••-PC	388	FJS45•••••	1015	FM•••••NYC	805	FR3C6025F	837
FC•••••-PC	387	FJS45-20Z-20	1015	FM•••••NYFD	805	FRA	110
FCSB•••	371	FJS90•••••	1015	FM••NYFD••F	805	FRA-C	110
FCSM•••	371	FJS90-20Z-20	1015	FM••NYFD••T	805	FRA-NI-C	111
FC•••••ST•••	378	FL•••••	578	FMR•••	951	FRC4025	835
FC•••••ST••	383	FL•••••	578	FMR•••••	951	FRC4025F	835
FD47-C2	772	FLBV•••CS	898	FMR•••••	385	FRC6025	835
FD47IR-150-100	772	FLC0318••	559, 989	FMR•••••	385	FRC6025F	835
F••E-SKIT	401, 533	FLC0319••	559, 989	FMR•••••	385	FR-CAP	110
F•E-SKIT	401, 533	FLC2402•••••	557, 987	FM••S••	804	FRP-95•••	312, 313
FFB•••	562, 906	FLC2403••	558, 988	FMS•••	951	FRP-96•••	312
FFC•••	562, 906	FLC2404••	557, 987	FMS•••••	951	FRRE-T••	1017
FFH15NYFD15NYFD	795	FLC2404•••••	557, 987	FM••S••F	804, 805	FR-RS	110
FFH••••F	795	FLC2405••	558, 988	FM••S••F-D	803	FR-RS-C	110
FFH•••F•F	795	FLC2405•••••	558, 988	FM••S••T	805	FR-RS-R	110
FFH••••NYFD	795	FLC2500••	559, 989	FM••S••T-D	803	FRR-T••	1017
FFH•••T••S	795	FLC2501••	558, 988	FM•••••T	804, 805	FRS	110
FFN•••	791	FLC2501•••••	558, 988	FN600	110	FRS-C	110
FFN75GHT	791	FLC2603••	559, 989	FN600B	110	FRSGX••	1067
FFN•••NST	791	FLG•••E	964	FN600BL	110	FRSGX110	1067
FFS•••	562, 906	FLSS•••	390	FN600BL-NI	111	FRT•••••	935
F••G•••••	593	FLSS200-BSP•	390	FN600B-PLUG	110	FRX	111
FGH••	410	FLSS200-NPT•	390	FN600S	112	FRX-C	111
FH-SC•••A••CS	727	FLSS••••A	390	FNB75GHT	412, 781	FS•	469
FH-SC1230A30CS	727	FM•••	951	FNB75GHT-GD	414, 1080	FS••	469
FH-SC•••B••CS	727	FM•••••	804, 951	FNB75S	781	FS•••	469
FH-SC1230B30CS	727	FM25NYC25F	805	FNBE150NST	786	FS304C•	540
FHCD	473	FM25NYC25T	805	FNBE150S	786	FS304C••	540
FHCS150	830	•FM••B	1086	FNB•••NST	781	FS2403•	539
FHHR•	775	FMB•••	951	FNB•••S	781	FS2403••	539
FHHR-C	775	FMB•••••	951	FNG•••NST	786	FS2404•••	539
FHHR-C•	775	FMBV••F••F	863	FNG•••S	786	FS2404•••••	539
FHPR150	776	FMBV••S••S	863	FN•••NST	781	FS2408•	540
FHPR150-100CBF	776	FM•••••F	804, 805	FNPSO150•••	792	FS2408••	540
FHPR150••CBF	776	FMF•••	550, 950	FN•••S	781	FS2501•••	540
FHPR2515	776	FMF•••••	550, 950	FNS	112	FS2501•••••	540
FHR-C	770	FMF••••45	550, 950	FNS2	112	FS2603•	540
FHR-C1	770	FMF•••••45	550, 950	FNSID	112	FS2603••	540
FHR-V•	770	FMF••••90	550, 950	FO•	469	FS6400••	539
F••H-SKIT	486	FMF•••••90	550, 950	FO••	469	FS6400•••••	539
F•H-SKIT	486	FM•••••F-D	803	FO•••	469	FS6500•••	539
FJB•••••	1014	FM••F••F	804, 805	FOS•	469	FS6500•••••	539

# Part Number Index

	Page #		Page #		Page #		Page #
FS6602•	540	FX1500	111	G•••C••	77	GHD-500AN4	1079
FS6602••	540	FX1500P	111	G•••C••••	77	GHD-500GH4VBK	1080
FS6801•••	539	FX1500PLUG	111	G••••C••	82	GHD-500GHV	1078
FS6801••••	539	FX1500S	111	GC•	153	GHD-500GHY	1080
FSA••••F	822	FX1500SP	111	GC••	345, 350	GHD-500QCK	1078
FSA••••S	822			GC230	1088	GHD-500YC	1080
FSA••••T	822			G•••C•••CR	7	GHD-1781212C	1078
FSB	112	G••••00	970	G••D••	78	GHD-5061212C	1079
FSCV••	913	G•00-AL-AL	83	G••D••	78	GHD-5891212K	1078
FSCV•••	913	G•00-DL-AL	83	G•••D••••	78	GHD-5911212F	1079
FSGLBV••	901	G5•••	582	G••••DA••	81	GHD-5911212W	1079
FSGLBV•••	901	G9	127	G•••D-ALNST	85, 815	GHD-AAPN75GHT	1078
FSGR••F	872	G10	127	GDB•	155	GHD-BN6	1080
FSGV••	900	G75HRPSS	83	GDB••	155	GHD-CNB75GHT-GD	1080
FSGV•••	900	G400•LT-AL	82	G••DC••	80	GHD-CWH50	1081
FSGV•••F	860	G3050	140, 1027	G•••DC••	80	GHD-HA1576	1079
FSH-9682•••	765	G12014	768	G•••DC••••	80	GHD-HA2576	1079
FSH-9682•••B	765	G••A••	75	G•••DD••	81	GHD-HSS8	1081
FSH-9682•••C	765	G•••A••	75	GDF•	163	GHD-HSS12	1081
FSH-9682•••NS	765	G••••A••	82	GDF••	163	GHD-POSTER	1082
FSH-9682•••Q	765	G•••AA••	81	GDL•	163	GHD-PSN76	1078
FSH-9682•••W	765	G••••AA••	81	GDL••	163	GHD-RETAILKIT	1077
FST••	361	G•••A-ALNST	85, 815	G••DP••	80	GHD-SGH50	1081
FST•••	361	GAB•	180, 181	G••DP••	80	GHD-SIGN	1082
FST••CS	10	GAB••	180, 181	G•••D-SSBSP	84	GHD-SN75	1079
FSW•	830	GAM•	182	G••E••	79	GHGN	417
FT••	934	GAM••	182, 183	G•••E••	79	GHN75	788
FT•••	934	GAS••••NO	44, 362	G••••E••	82	GHN75-B	788
FT6••	142	GAS••••NOS	45, 363	G••••E	967	G••HRP	83
FT6•••	142	G•••A-SSBSP	84	G•••E	967	G••HRP	83
FT6•••4	142	GAS••••TO	579	G•••E••CR	8	G••HRPSI	83
FT7•••	142	GAW	829	G••F••	79	G••HRPSI	83
FT7••••	142	G••B••	76	G•••F••	79	G•••••HRPSS	83
FT7••••4	142	G•••B••	76	GF•	153	G••HRPSS	83
FT530	141	G•••B••••	76	GF••	153	GHV	416
FT590••	141	GB•	153, 154	GF•••	153	GHY	416
FT590•••	141	GB••	153, 154	GF26-1	153	GHYV	416
FT••B	934	GB6-1	153	GF81	1097	GIBFV••	966
FT••FS	934	GBA••	163	G•••F-ALNST	85, 815	GJ••	163
FT••FS	934	G•••B-ALNST	85, 815	GFAS•	156	GL••	264, 345, 350
FT••G	934	GBB••	163	GFAS••	156	GL130	1088
FT••G	934	G••BL	962	GFN150	790	GLBR••	353
FTH100	778, 1068	GBN150	779	GFN150NST	790	GLBR•••	353
FT••SS	934	GBN••NST	779	GF••P•	155	GLBR••••	353
FT••SS	934	GBR••	347	GF••P•	155	GLBR•••4	353
FVFA••	391	GBR•••	347	GFR•	112	GLBR••••4	353
FVL••	391	GBR••••	347	GFR••	112	GLBR•••••4	353
FVS••	391	GBRW••	353	GFR1•	112	GLBR•••••4	353
F••V-SKIT	501	GBRW•••	353	GFR1••	112	GLBRC••	353
F•V-SKIT	501	GBRW••••	353	G•••F-SSBSP	84	GLBRC•••	353
FVSP••	391	GBRW30R	353	GGH75	411	GLBRC••••	353
FWV••F••F	861	G•••B-SSBSP	84	GH••••	160	GL••FG	348
FWV••S••S	861	G••C••	77	GHC7	422	GLP••	351



	Page #		Page #		Page #		Page #
GLS...	351	H...	587, 958	HBC•S	471	HGV250F	858
GLSC...	351	H1DC	485, 515	HBC•S	471	HGV250F-D	858
GLSS•	352	H4F4-HV	484	H•BF•	483	HGV250-H	858
GLSS...	352	H5...	582, 586	H•BF•	482	HGV-HDWHL	859
GLSS•••	352	H5••-BU	582	H•BF••-B	483	HGV-KNOB	859
GLSS••••	352	H5••-NST	582	H•BF•-B	482	HGVW250F	859
GLSSC...	352	H5••R50UC	755	HB•F•M	449, 925	HGVW250-W	859
GM•	155	H5••R100UC	755	H•BF••-S	483	HHA•••	802
GM••	155, 264	H52••-A	582, 584	H•BF•-S	482	HHCI	445
GMAS•	156	H52••-A-BU	582, 584	HB•••FS	924	HHD••P	570
GMAS••	156	H52••CS	584	H•BF••-SS	483	HHD••T	570
G••N	962, 967	H52••L-A	584	H•BF•-SS	482	HHP•M	455, 938
GNB75GHT	414	H52••L-A-BU	582, 584	HB•••G	264, 923	HHTP	1060
GPA-95•••	314, 315, 316	H52••NST	582	HB•••SS	923	H•M•	482
GPA-95-292	1061	H515R50•••	755	H•••-BU	586	H•M•-S	482
GPA-96•••	315, 316	H515R100•••	755	H••BU	958	HN	114
GPA-97•••	316	H525R50•••	755	H••BU	958	HNBGH••	421
GROOVLUB32	968	H525R100•••	755	HC90	1003	HNBGHF••	421
GRP-95•••	312, 313, 314, 316	H610Y50•••	757	HC90RB	1003	HN•M•M	452, 928
GRP-96•••	312, 313, 314, 316	H615Y50•••	757	HC30143	777	HN-P	114
GS••4	345	H625Y50•••	757	HD1••	568	HN-PLUG	114
GS•••4	345	HA•••	412, 800	HDBF75	915	HN••SS	928
GS••••4	345	HA023•	591	H•DC-A	485	HN•SS	928
GSAFETYCLIP	83	HA024•	591	H•DC-A	485	H•OF•	482
GSS•	346	HA25NYC76	802	HDPE•••	969	HP•	463
GSS••	346	HA25NYFD15NYFD	802	HDPE•••BU	969	HPBV••	561, 897
GSS•••	346	HA0900••	949	HDR150-100G	774	HPBV•••	561, 897
GSS••••	346	HA2515F	777	HDR150-100GACC	774	HPBV••-3WAY	561, 897
GSS••••4	346	HA•••ADP	64, 814	HDR150-100PCR	774	HPBV••SAE	561, 897
GSS••4	346	HAB••EZ	52	HDR150-100PCRAC	774	HPBV••SAE	561, 897
GSS•••4	346	HAC••EZ	52	HDSSF75	915	HPBV••SAEZPL	561, 897
GSS••••4	346	HA••••D	802	H•F••	483	HPBV••SAEZPL	561, 897
GSTC•	360	HAD••EZ	52	H•F•	482	HPBV••SS	561, 897
GSTC••	360	HA•••F	800	H•F••-B	483	HPBV••ZPL	561, 897
G•••T	967	HA•••F-D	802	H•F•-B	482	HPBV••ZPL	561, 897
G••T	962, 967	HA••NYC••T	802	H•F•-BOP	488	HPFN150	780
G•••V	967	HA••NYFD76	802	HFN••	780	HPFN150NST	780
G••V	967	HA••NYFD••F	802	HFN150NYFD	780	HPSG	402
G••VB	962	HA••NYFD••S	802	HFN••NST	780	HPSGHD	402
GWDGV250F	856	HA••NYFD••T	802	HFN-P•	117	HPSGL	402
GWH••••	456	HA••S••	800	HFR-C•	117	HPSGW	402
GWH••••	456	HA••S••F	800	H•F••-S	483	HR	114
GWH1•00R	456	HA••S••S	800	H•F•-S	482	HR1610	775
GWH-C	456	HA••S••T	800	H•F••-SS	483	HR1610••	775
GWHC	456	HA•••T	800	H•F•-SS	482	HR-C	114
GWHC-FF	456	HA•••T-D	802	H•F•-SS-BOP	488	HRC•••	568
GWHZ••	457	HA••T••F	800	HGB100S	781	HR-CAP	114
GWHZ••R	457	HA••T••S	800	HGB•••NST	781	HS•	460
H••	958	HAV3EA•••	746	HGCFB150S	787	HS••	460
		HAVNEA•••	746	HGCFB•••NST	787	HS•••	460
		HB••	366, 1004	HGG100NST	786	HS••AL	1044
		HB••••	264, 923	HGG100S	786	HS•BF•	489
		HB••••B	924	HGV250	858	HS•BF•-B	489

# Part Number Index

	Page #		Page #		Page #		Page #
HS•BF•S	489	HT•F•SS	506	HUSP500	169	J2M2-B	202
HSCE•••	743	HT•F••SS	506	HVF••••-25	833	J47	163
HSC-RKE•••	743	HT•JB•	507	HVG0•••-25	833	J844••••-100	1000
HSC-RKV•••	743	HT•M•	506	HWH50	411	J844•••-BL-100	1000
HSCV•••	743	HTM•••	463	HWH50-75	411	J•B•	203
HS•F•	489	HT••OF••	506	HY•	568	J•F•	202
HS•F•-B	489	HT•OF•	506, 1091	HY••	568	J•M•	202, 1086
HS•F•-S	489	HT•OF••	506	H••Y50SZ	757	J•S•	202
HSGE•••CCA	725	HT•OM•	506	H••Y50UC	757	JS••	471
HSGP•••CCA	725	HT•RB•	507			JX••	477
HSG-POLY•••	725	HT•SKIT-V2	508	IA••TP	1061	K•	470
HSG-RKE•••	725	HTSW	828	IB••	34	K••	470
HSG-RKP•••	725	HTW••P	569	IBFVW•••	903	K•••	470
HSG-RKV•••	725	HTW••T	569	IBFVW•••E	903	K4•-DC	491
HSGV•••CCA	725	HU100•••	168, 947	IBR••••	1000	K4DC	491, 1093
HSR••	771	HU100•••BW	168, 947	IBV••	896	KB••	154
HSR••••	771	HU200•••	168, 947	IBV•••	896	K•BF••	490
HSRC••	770, 771	HU200•••BW	168, 947	IBV50BOV	1061	K•BF•	490
HSRC••••	771	HU206•••	168, 947	IC••	36	K•BF•-SS	490
HSS•	460	HU400•••	948	ICL••••	999	K•F••	490
HSS••	460	HU602•••	948	ID••	41	K•F•	490
HSS•••	460	HU602•••BW	948	ID••TC	1061	K•F•-SS	490
HS••SS	1044	HU1002•••	948	IH••	48	KHN•••	365
HST••	358	HU1002•••BW	948	IH6	66	KLW•	377
HSTBC•••	467	HU1502•••	949	IHC••F	819	KLW••	377
HSTBC••••	467	HU1502•••BW	949	IHSC34	66	KM••	368
HST••P	569	HUC20••00	169	IHSC152	66	KM•••	368
HST••T	569	HUC20••00BC	169	IRC4025	835	KNW•	377
HSW•••	952	HUC100400	169	IRC4025F	835	KNW••	377
HT49OF•	507	HUF206200MT	171	IRC4025GF	835	K•OF•	490
HT•BAND•	504	HUF206400FLG	170	ISCS4025F	838	KRN•••	365
HTBC•••	467	HUF206400FLG-45	170	ITD••	1015	KRN••••	365
HT••BF••	506	HUF206400FLG-ST	170	ITDH	1015	KRW•	377, 414, 782
HT•BF•	506	HUFALL•00FLG	170	IXAN••	589	KRW••	377, 782
HT•BF••	506	HUFALL••CS	165	IXF•••	581	KRW••••	377
HT•BF•-SS	506	HUFALL•••CS	165	IXF••••	581	KS•	470
HT•BF••-SS	506	HUF•••••CS	165	IXFDPLG•••	588	KS••	470
HTBG	280	HUM206•00FLG	170	IXFS••	589	KS•••	470
HTBG•	280	HUM206400FLG	170	IXFS32-3A	589	KS••••	1069
HTBG••	280	HUM206400FLG-45	170	IXH••	580	KSS••	263
HTBG•••	280	HUM206400FLG-ST	170	IXM••	580	KSV10•••	275, 911, 1095
HTBG-CT	280	HUM•••••CS	166	IXMS••	589	KSW••	263
HTBG••EXT	280	HUMF206400••	171	IXPE32-3A	588	KVW••	377
HTBG•EXT	280	HUMF•••••CS	165	IXSE••	588		
HT•DC	507	HUMF•••••N	167	IXSE••-3A	588	L••	960
HTE•BF•	509	HUP207400	169	IXV••	581	L•••	960, 965
HTE•BF••	509	HUP207400DC	169	J••	477, 567	L••••	965
HTE•F•	509	HUPALL•00	169	J•••	72	L0•BL	962
HTE•F••	509	HU•••••RN	167	J2F2-B	202	L2•2	208
HTE•OF•	509	HU•••••RN3	167			L03•0•A	290
HTE•OF••	509	HUS500N	167				
HT••F••	506	HUS500RN	166, 167				
HT•F•	506, 1091	HUSF500SW	166				
HT•F••	506	HUSM500SW-1	166				

Page #	Page #	Page #	Page #
L03-0•AMB .....290	LCTS• .....1056	LV•N6D .....311	ME109-NH3-1 .....973
L07-200AC .....317	LCTS14 .....1056	LV•NAD .....311	ME502-12/8 .....971
L07•••A .....318	LDC2 .....274, 908	LW••200 .....1069	ME3162-32B .....972
L08-02A .....290	LDCF2 .....274, 908	LWSG• .....396	ME3162-32S .....972
L08-02AMB .....290	LDCM2 .....274, 908		ME•••F• .....973
L14AJP-G•• .....644	L•••DC-SS .....30, 177	M• .....160	ME•••FS• .....973
L14AJP-R•• .....644	L•••DP-SS .....30, 177	M•• .....160	MEP120B .....972
L14AM7-G•• .....600	L•••E-SS .....30, 177	M•••• .....381	ME•••S .....971, 972
L14AM7-G••• .....600	LFV•• .....879	M2•2-B .....204	ME•••S• .....973
L14AM7-G•••• .....600	LFV••• .....879	M2B2 .....205	ME•••S•• .....971
L14AM7-R•• .....600	LHC95 .....1003	M16-03A .....1061	MEW• .....972
L14AM7-R••• .....600	LHC95RB .....1003	M16-03M .....1061	M•F• .....204
L14AM7-R•••• .....600	LHFS400F .....832	M16••A .....294	MFB•• .....562, 906
L14AM7V-R•• .....665	LHFS4045F .....832	M16••M .....294	MFC•• .....562, 563, 906, 907
L14AM7X-R•• .....665	L•••HSCRPI-SI .....31, 178	M18••A .....294	MFC•••• .....562, 906
L15AJP-G•• .....644	LHW .....830	M18••M .....294	MFS•• .....562, 563, 906, 907
L15AJP-R•• .....644	LJ•• .....956	M26••A .....294	MFS•••• .....562, 906
L16••A .....303	LJ••• .....956	M26••M .....294	M••••GAX .....761
L16••AMB .....303	LJD•• .....955	M28••A .....295	MGC• .....461
L17-800APX .....330	LJD••• .....955	M28••M .....295	MGC•• .....461
L17•••A .....329	LJR•• .....956	M30••A .....295	MGC••• .....461
L17•••D .....331	LLBV2515F .....862	M35-0•AMB .....296	MGC-10PC .....464
L18••A .....304	LM•••* .....579	M•200 .....269, 272	MH• .....460
L18••AMB .....304	LM••••* .....579	M5834F .....418	MH•• .....460
L26••A .....304	LNG••BRFE .....107	M5834HM .....418	MIC•• .....936
L26••AMB .....304	LNGBRFECAP .....107	M5834M .....418	MIC••• .....936
L28••A .....305	LNG••BRFE-NC .....107	M7400••• .....555	MICAP•• .....937
L28••AMB .....305	LNG••BRHE .....107	M7400•••• .....555	MICAP••• .....937
L30••A .....305	LNG••BRHE-NC .....107	M7455••• .....555	MICAP•••G .....937
L30••AMB .....305	LNG••BRHENUT .....107	M7455•••• .....555	MICAP••G .....937
L40-0BA .....306	LNGBRHEPLUG .....107	MA•• .....370	MIU•• .....922
L40-0BAMB .....306	LNG••FESEAL .....107	MAH• .....460	MIU••• .....922
L50-0CA .....306	LOCKINGDEVICE .....827	MAH•• .....460	M••••KAF .....761
L50-0CAMB .....306	LOCKINGDEVICE6 .....827	MA•••N .....371	M••••KAS .....761
L72M• .....328	LP•• .....160	MB•• .....370	ML•00M .....269
L72M••MB .....328	LP•••• .....160	MBV•• .....880	MLS•• .....374
L73M• .....328	LPB•• .....160	MC•• .....563, 907	M•M• .....204, 1086
L73M••MB .....328	LR•••• .....386	MC••• .....382, 383	MOC250NYC-P .....804
L73M••MBPX .....330	LR••••• .....386	MC•••• .....379, 382, 383	MOC250NYFD-P .....804
L74C• .....331	LR7 .....74	MCH50 .....411	MOC3025F• .....804
L74C••MB .....331	LRHEZ•• .....31	MCM•••• .....382	MOCA250F .....847
L74M• .....329	LRHEZ••• .....31, 178	MCM••••XL .....385	MOC•••F• .....804
L74M••MB .....329	LRHEZ34 .....178	MC••••PC .....388	MP•••• .....385
L74M••MBPX .....330	LRP-95••• .....314	MC••••PC .....387, 388	MP••••• .....381, 385
L606••W .....342	LRP-96••• .....314	MCS•• .....371	MPB•••• .....1014
L•••A-AL .....29, 176	LS•• .....465	MC••••ST•• .....379	MPB-20Z-20 .....1014
L•••A-SS .....29, 176	LS••• .....465	MC••••ST••• .....383	MPC•••• .....1014
L•••BU .....960	LSS•• .....465	MD••••T .....766, 768	MPC-20Z-20 .....1014
L••BU .....960	LUAS-08 .....1058	ME•• .....971, 972	MPC-T•• .....1016
LCJS••• .....1056	LUCP-14 .....1058	ME•••• .....973	MPR-T•• .....1016
LCJS12-15 .....1056	LUPG-08 .....1058	ME••••• .....971	MPS•••• .....1014
LCLD .....1056	LUPO-16 .....1057	ME•••••• .....972	MPS-20Z-20 .....1014
L•••C-SS .....29, 176			M••••RAF .....760

# Part Number Index

	Page #		Page #		Page #		Page #
M.....RAF	760	N4S6-LS	1098	NAPRVFT.....	867	OCTOE32	951
M.....RAS	760	N4S-B	192	NAPRVGT.....	866, 867	OCTOES32	951
M.....RAS	760	N4S-B-LS	192	N•BM•	191	OCTS••	952
M.....RAT	760	N4S-B-LS-WF	193	N•CS	10		
M.....RAT	760	N4S-B-WF	193	NCS-CSF-STZ••	825	P•	434
MRCH••	921	N4S-LS	192	NCS-CSF-STZ••C	825	P••	434
MRCH•••	921	N4S-LS-WF	193	NF307Y50GHT	756	P1A•••A	319
M•S•	204	N4S-S	192	NF307Y50GHT-KIT	756	P1A•••M	319
MS•	159	N4S-S-LS	192	NF610Y50••	756	P-4EA-SKIT	534
MS••	159	N4S-WF	193	NF610Y100••	756	P4F•	194
MS•••	563, 907	N35-•F•F	799	NF615-50RAQT	756	P4F6-9	194
MSA•••F	824	N35-•S•F	799	NF615Y50••	756	P4F6-S	194
MSA•••S	824	N35-•S•S	799	NF615Y100••	756	P4F-B	194
MSA•••T	824	N36-•F•F	814	NF615100RAQT	756	P4M•	195
MSBC••SS	105	N36-•F•T	814	NFSGX••	1067	P4M6	1098
MSBC••SSMNPT	105	N36-•S•F	814	NFSGX1••	1067	P4M6-9	195
MSP•••	406	N36-•S•S	814	N•F-SS	190	P4M6-S	195
MSP4PAK	406	N36-•S•T	814	NG••	624, 629, 957	P4M•B	195
MSP-95-•••	312	N36-•T•F	814	NK2••	210	P8A-860•	332
MS••••T	766	N36-•T•T	814	NK2S2	210	PAP250	820
MS•X•	159	N37-•F•F	806, 807	N•M•	191	PBC250	819
MS•X••	159	N37-•F•G	806, 807	N•M-SS	191	PBLSS••	349
MS•X•	159	N37-•F•S	806, 807	N••NO	362	PBLSS•••	349
MS•X••	159	N37-•F•T	806, 807	NPT••TC	1061	PBLSS••••	349
MT•••	356	N37-•G•F	806	N•S-SS	192	PCDVCHSS36	100
MT••••	963	N37-•G•S	806	NST••TC	816	PD•F•	515
MT•••••	963	N37-•G•T	806	NV4M	273, 909	PD•M•	515
MT••••••	963	N37-•S•F	806, 807	NV•F	273, 909	PD•OM•	515
MTP-95-•••	312	N37-•S•G	806	NW••	957	PEDF75	915
M••••UC	759	N37-•S•S	806, 807	NW•••	957	PEDF200	915
M••••UC	759	N37-•S•T	806, 807	NZ••••	406	P-•E-SKIT	401, 533
		N37-•T•F	806, 807	NZ6540QCS	406	P-E-SKIT	401, 533
		N37-•T•S	806, 807	NZMMEG5P•••	406	PFC250F	818
		N37-•T•T	807	NZMQC5P-•••	406	PFC250U	818
N••	361	N53-•F•F	798	NZ••••S	406	PFCW•••	818
N•••	361	N53-•F•T	798			PFCW•••F	818
N3CS4	192	N53-•S•S	798	O246BU	123, 1026	PFCW•••F-Y	818
N4BF•	190	N53-•S•T	798	O249BU	123, 1026	PFN4005•	792
N4BF•-B	190	N54-•-25F25F	832	OA••	458	PFNB150NST	786
N4BM•-B	191	N54-•F•F	810	OA-4N-SKIT	1095	PFNB••S	786
N4BM•-LS	191	N54-•F•T	810	OA-4P-SKIT	1095	PG700	278
N4DC	192	N54L-•F•F	810	OA-3512	1095	PG8083	1062
N4DC-B	192	N54L-•F•T	810	OA-AC1	1095	PGA150NPSH	789
N4F•	190	N54-•S•S	810	OA-ACL8	1095	PGA••NST	789
N4F6-S	190	N54-•S•T	810	OA-AWR4	1095	PGH50	410
N4F•-B	190	N56-•F•F	801	OA-KSV10-125	1095	PGH100	410
N4F•-B-LS	190	N56-•F•T	801	OA-KSV10-150	1095	PGS••	347
N4M6-LS	1098	N57-•F•F	799	OA-RETALKIT	1094	PGS•••	347
N4M6-S	191	NAPRAV••F••	865	OA-SIGN	1101	PGS••••	347
N4M6-S-LS	191	NAPRAVF•••••	865	O••BU	166, 169, 170	PHDN75	413
N4M•-B	191	NAPRAVGFT•••••	867	Oct-32	952	PHFA6	777, 851, 1066
N4M•-B-LS	191	NAPRAVGT•••••	867			PHFA-B-A	851, 1066
N4M•-LS	191	NAPRVF•••••	866				
N4S•	192						

Page #	Page #	Page #	Page #
P••H-SKIT .....486	PPB•• .....86	PU•••• .....283	R1•S-A .....583, 585
P•H-SKIT .....486	PPB••• .....86	PU1425-CBG .....283	R2AAS .....583
PHW .....829	PPC•• .....87	PV••• .....898	R•••-02C .....340
PL••• .....268, 1100	PPC••• .....87	PVFP•• .....898	R•••-02CG .....340
PL400LWF .....269	PPCF•• .....1008	PVFP••• .....898	R2•S .....583
PL400WF .....269	PPCM•• .....1008	PVFPN••• .....899	R2•SS-A .....585
PL•••L .....268	PPD•• .....87	PVFPS200 .....899	R03-0•R .....288
PLUG•••F-C .....820	PPD••• .....87	PVFPSA200 .....899	R03-0•RG .....288
PLUG•••S-C .....820	PPDV75 .....871	PV-HDWHL .....872	R3AAAS .....583
PN••• .....951	PPE•• .....88	PV-KNOB .....872	R3AAS .....583
PN•••• .....951	PPE••• .....88	PVN200 .....899	R3AASS-A .....585
PN15 .....783	PP•••F .....820	P••V-SKIT .....501	R3•S .....583
PN15F .....783	PPF•• .....88	P•V-SKIT .....501	R3•SS-A .....585
PNB75GHT .....413	PPF••• .....88	PW6••B50•• .....754	R4•SS-A .....585
PND-450-4S .....1088	PPH•• .....89	PW6••B100•• .....754	R07-200RGC .....317
PND-1020604C .....1085	PPH••• .....89	PW-AL•• .....1074	R07•••R .....318
PND-B07-202AGC .....1084	PPLSS•• .....1006	PW-AL323XX .....1076	R07•••RG .....318
PND-B07-202MGC .....1084	PPM• .....369, 1007	PW-AL324XX .....1076	R08-02R .....289
PND-CC1412 .....1088	PPN•• .....366, 1004	PW-AL-TPR25•• .....1075	R08-02RG .....289
PND-D101 .....1085	PPN••• .....1004	PW-BLU-BINS .....1073	R8P2SS .....577
PND-D104 .....1085	PPP•• .....89	PW-E3F3 .....1073	R11•••RG .....324
PND-D201 .....1087	PPP••• .....89	PW-E3M3 .....1073	R15AAAS-A .....583, 585
PND-D204-30 .....1087	PPSO150• .....792	PW•EF•B .....1073	R15AAS-A .....583, 585
PND-D3406 .....1087	PP•VEU•MG .....997	PW•E•F•B .....1073	R15•S .....583
PND-DATL016 .....1089	PP•VFC•MG .....996	PW•EM•B .....1073	R15•S-A .....583, 585
PND-DATL128 .....1089	PP•VFE•MG .....996	PW•E•M•B .....1073	R16••R .....298
PND-DFG2 .....1085	PP•VMC•MG .....996	PW•F•F .....863	R16••RG .....298
PND-DFG5 .....1085	PP•VME•MG .....996	PW-HPSG .....1075	R16••RH .....298
PND-DQCKIT1 .....1086	PP•VTEU•MG .....997	PW-MSP•• .....1074	R16••RHG .....298
PND-DQCKIT2 .....1086	PP•VUC•MG .....997	PW-MSP4PAK .....1074	R17•••R .....324
PND-DQCKIT3 .....1086	PRC .....776	PW-NZ•••• .....1075	R17•••RG .....324
PND-DQCKIT4 .....1086	PRN•••F .....776	PW-NZ••••S .....1075	R18-C05R .....324
PND-DQCKIT5 .....1086	PRWB .....776	PW-POSTER .....1076	R18-C05RG .....324
PND-DQCKIT6 .....1086	PS•• .....343, 344	PW-RETAILKIT .....1072	R18••R .....298
PND-F07-200AC .....1084	PS-12HF12-B .....489	PW-SIGN .....1076	R18••RG .....298
PND-F07-200MC .....1084	PS403 .....312	PW•S•S .....863	R21••R .....297
PND-GAUGEKIT1 .....1088	PS417B .....316	PYLS•••• .....970	R21••RG .....297
PND-L07-200AC .....1084	PS506 .....343	PYLS••••• .....970	R25•S .....583
PND-POSTER .....1089	PS-H12F12-B .....489		R25•SS-A .....585
PND-PU1425 .....1088	PSM•••• .....283		R26••R .....299
PND-R07-200RGC .....1084	PSN76 .....413	QTF75GHT-F .....769	R26••RG .....299
PND-RETAILKIT .....1083	PSNP250NYC .....821	QTF••••F .....769	R26••RH .....299
PND-SIGN .....1089	PSNP250S .....821	QTG-F .....769	R26••RHG .....299
PND-SK1098 .....1087	PSNP•••NST .....821	QTM75GHT-F .....769	R28••R .....300
PNS••• .....951	PSNP•••NYFD .....821	QTM••••F .....769	R28••RG .....300
PNS•••• .....951	PSW .....828	QTX150-F .....769	R30••R .....300
POLYHA•••• .....803	PSW• .....828		R30••RG .....300
POLYHA15S15F .....803	PT••• .....356		R30••RH .....300
POLYHA2515F .....803	PTH•••AG .....319	R• .....434	R30••RHG .....300
POLYHA2520T .....803	PTLS7540 .....970	R•• .....434, 961	R40-0•R .....301
PP250NYFD .....820	PTLS10040 .....970	R••• .....961	R40-0•RG .....301
PPA•• .....86	PTP .....1060	R1AAAS-A .....583, 585	R40••RH .....301
PPA••• .....86, 1008, 1009	PTTF150• .....792	R1AAS-A .....583, 585	R40••RHG .....301

# Part Number Index

	Page #		Page #		Page #		Page #
R43-•••RG	326	RB12SC	156	RD-HT40F5	1091	RHC•••	921
R46-•••R	272	RB•••BL	34	RD-K4DC	1093	RHC•••B	921
R46-•••RG	272	RB•••EZ	34	RDL•••EZ	61	RHC•••B	921
R72G-•R	323	R•••BU	961	RDM•	367	RHC•••FS	921
R72G-•RG	323	R•••BU	961	RDM••	367	RHC•••FS	921
R72M-•R	325	RBU•	161	RD-RETAILKIT	1090	RHC•••G	921
R72M-•RG	325	RBU••	161	RDWBPST•••EZ	63	RHC•••G	921
R73G-•R	323	RC•••BL	36	RDWSP•••EZ	62	RHC•••SS	921
R73G-•RG	323	RC•••BLNO	36, 37	RE••••••	44	RHC•••SS	921
R74G-•R	324	RC•••CEZ	37	REL••••	931	RH•••EZ	49
R74G-•RG	324	RC•••EZ	38	R-EN	115	RHEZ6	67
R75AAAS	583	RC•••EZ••	39	RE•••NO	44	RHEZ34	67
R75AAS	583	RC••••EZCR	56	R-EN-P	115	RHEZ152	67
R75•S	583	RC•••EZCR	6, 38	R-EN-PLUG	115	RHEZ175	67
R83-200R	325	RC•••EZNO	38, 39	REP400AS/SP	848	RH•••••F	768
R91-221RG	325	RC•••EZPF	38	REP•••AS	848	R-HN	116
R119-••C	341	RC•••EZSWIV	25	REP•••AS••	848	R-HN-P	116
R119-••CG	341	RC•F•F	449, 920	RE•••PF	43	R-HN-PLUG	116
R125AAS-A	583, 585	R-CN	115	REP•••HY	848	RHN•••SS	928
R125•S-A	583, 585	R-CN-P	115	REP•••PT	848	R-HR	116
R200SS	72	R-CN-PLUG	115	REP•••SP	848	R-HR-C	116
R364-02C	340	R-CR	115	REP•••SP••	848	R-HR-CAP	116
R364-02CG	340	R-CR-C	115	R-ER	115	RHS•	389
R374-02C	340	R-CR-CAP	115	R-ER-C	115	RHS••	389
R374-02CG	340	RD•••	768	R-ER-CAP	115	RHS•••	389
R504-••••	424	RD•••••	768	RES••	373	RHSC34	66
R515-50•••	755	RD-2AGSET-PV	1092	RES•••	373	RHSC152	66
R515-50•••/F	755	RD-3AGSET-PV	1092	RFC•••	816	RHSC175	66
R515U50•••	754	RD-4AGF4	1091	RFC•••F	816	RIC150F	847
R515U50•••/F	754	RD-4AGSET	1091	RFC•••F-•	816	RJT-•••SP	648
R515U100•••	754	RD-4AGSET-PS	1092	RFP•••F	821	RK•••	282
R515U100•••/F	754	RD-4HTF4	1091	RFST••	361	RK119•	344
R1375•S	583	RD-4HTOF5	1091	RFST•••	361	RKB605WB	344
R515100•••	755	RD-4KDP	1093	RFST•••CS	10	RKR•••Y	344
R515100•••/F	755	RD-4K-G-DP	1093	RG••••	386	RLBEZ•••	24
RA••	423	RD-4K-Y-DP	1093	RG•••••	381, 386	RLC•••EZ	29, 176
RA•••	423	RD15•••	766	RGB•	153, 154	RLCEZ•••	24
RA79•	423	RD15193F	766	RGB••	153, 154	RLD•••EZ	30, 177
RA•F•M	450, 925	RDA90•••EZ	58	RGF••	153	RLDEZ•••	24
RAGG••••	964	RDA••••BL	54	RGFAS6	156	RLH•••EZ	30, 177
RAGG•••••	964	RDA••••EZ	54	RGFAS11	156	RLHEZ•••	24
RAM•	180, 181	RD-AG4F4	1092	RGF••P•	155	RLP••	160
RAM••	180	RD-AG4F4-PV	1092	RGMAS6	156	RM•	368
RAM7T	184	RD-AG40F4	1092	RH•••••	768	RMA•••	424
RAM•WF	184	RD•••BL	41	RHA••••	801	RMS•	159
RAP•••	1054	RDD••••EZ	55	RHA••••F	801	RMS••	159
RAPDISPLAY	1054	RDD•••EZ	55	RHA•••S•	801	RN••	361, 426
RAPDISPLAYFILL	1054	RD•••EZ	42	RHA•••S•F	801	RN•••	361, 426
RAS•••	424	RD•••EZHD	42	RHA•••S•T	801	RNB150NST	787
RB•	157, 161	RD•••EZSWIV	25	RHA••••T	801	RNB150S	787
RB••	154, 157, 161	RD•••••F	768	RHA•••T•F	801	RN••CS	10
RB3-0•R	289	RD•••F	768	RH•••BL	48	RN•••NO	362
RB3-0•RG	289	RD-HT4F4	1091	RHC••	921	RNW••40	957

	Page #		Page #		Page #		Page #
RNW***-40	957	R-TR-C	116	SCCW***	479	SFMF***	550, 950
R**P*	577	R-TR-CAP	116	SCM**	271	SFMF****	550, 950
R**P***	577	RTW**	768	SC***-NL	827	SFMF***-45	550, 950
RPA-95***	313	RTW150	767	SCS4025F	838	SFMF***-45	550, 950
RPA-96***	313	RWDGV250F	857	SCV**	276, 561, 912	SFMF***-90	550, 950
RPD-90150	175	RWDGV3025F	857	SCVH*	270, 910	SFMF***-90	550, 950
RPD-901510	175	RWF**	157	SCVH**	270, 910	SF***NYFD	796
R**P*LJR15	576			SCVJ*	270, 910, 1099	SF***S	796
RPN**	438	S**	370	SCVJ6	1099	SFSA30****F	825
R**P*SOR15	576	S***	370, 371	SCVL*	270, 910	SFSA30****F-LH	825
RRHS**	389	S****	766, 768	SCVL**	270, 910	SFSA****F	823
RRP-95***	314	S6175	862	SCVM*	270, 910	SFSA****F-LH	823
RRP-95-590	316	S6175S	862	SCVM**	270, 910	SFSA****S	823
RRP-96***	313, 314	S7100	862	SCVR*	270, 910	SG**	472
RS****	768	S7100-15	862	SCVS*	264, 270, 910	SGH**	410
RS15**	766	S7100-15S	862	SCVS**	270, 910	SGH***	410
RS15**F	766	S7337S	862	SCVS6	1099	SGP***	827
RSDM**	372	SA15Y57	344	SD**	372	SGS***-NL	827
RSE****F	832	SA161X57	344	SD*200	72	SGV**	860
RSE****F-C	832	SA200*W57	344	SD*300	72	SGV30***	860
RS****F	768	SA4050AL	1036	SD*400	72	SGV**F	864
RSF***F	796	SAEB****	1014	SDMP**	372	SGVF***	864
RSF**F*T	796	SAEC****	1014	SE45**	933	SHA5045F	826
RSFSA**F	795	SAHW	828	SE45***	264, 933	SHD2**	207
RSFSA**F*T	795	SAP*	361	SE45***G	933	SHD4**	207
RSHR**	372	SAP**	361	SE45**G	933	SHD*S*	208
RSK**	372	SAR10Y57	344	SE90**	932	SHELFGRAPHIC	1076, 1082, 1089
RSM***F	808	SB**	370	SE90***	932	SHP**	938
RSM**F*T	808	SB***	370	SE90*B	932	SHP***	938
RSM***S	808	SBC***AL	106	SE90*FS	932	SHP***B	938
RSMSA250F-Z	809	SBC***ALFL	106	SE90*G	932	SHP***FS	938
RSMSA***F	809	SBC***ALMNPT	106	SE90*SS	932	SHP**FS	938
RSMSA**F*T	809	SBC***ALTTMA	106, 143	SE*F*M	453, 931	SHP***G	938
RSMSA**F*T-Z	809	SBC***ALTTMASV	106, 143	SEGC0-*.****	1018, 1070	SHP**G	938
RSS**	389	SBC-E300CC13	721	SEGC1-*.****	1018, 1070	SHP**G	938
RST*	358	SBC-E300TP13	721	SEGS0-*.****	1018, 1070	SHP***SS	938
RST**	358	SBCS	187	SEGS1-*.****	1018, 1070	SHP**SS	938
RST***	360	SBC**SS	106	S****F	766, 768	SHS**	389
RST*A	359	SBC**SSFL	106	SF*20FGXFGCS00	136	SHS***	389
RSTB*	359	SBC**SSMNPT	106	SF*20FGXFGCS10	136	SIC250F	847
RSTB**	359	SBDV**	864	SF*20WXWCS00	136	SIC250F*	847
RSTB*CS	9	SBG	187	SF*20WXWCS10	136	SIGNHOLDER	1076, 1082, 1089, 1101
RST*CS	9	SB*N	371	SF300NYFDSS	841	SJSS***BB120	726
RST**NOS	363	SC**	479	SFC**	560, 904	SJSS***CC120	726
RST*PF	363	SC***	479	SFC***	560, 904	SJSS-REPAR-E**	726
RSTV**	359	SC****	479	SF***F	796	SJSS-REPAR-S**	726
RSTV*CS	9	SC***ABS	827	SF***F*	796	SK**	372
RTCA**	124	SCAP12-25	474	SF***F-D	796	SK1098	476
RTCT**	125	SCAP12-100	474	SF****FSS	841	SL**	189
R-TN	116	SCAP916-25	474	SF**FSS	841	SL***	786
R-TN-P	116	SCAP916-100	474	SF**F*T	796	SL075GHT	786
R-TN-PLUG	116	S*CC0*.000*C	614	SF**F*T-D	796	SL***CR	188
R-TR	116	SCCW***	479	SFJCT**CS	9		

# Part Number Index

	Page #		Page #		Page #		Page #
SL••F	188	SSBV••	882	STC-360-R••	722	SW80-•••••	945
SL••H	188	SSBV•••	882	STC••A	359	SW1530	831
SL••M	188	SSBV•••SR	884	STC••CS	9, 11	SWB-2	831
SL••NST	786	SSBV••SR	884	STC••CSHD	12, 173	SWB-S•	831
SLP1	189	SSBV••TW	881	STC-RK••	722	SWCV••	914
SLR•	189	SSBV••TW	881	ST•DC-A	514	SWCV•••	914
SLS••	374, 422	SSC••	420	ST•F••	513	SWDS	393
SLS4	154	SSCAP••	937	ST•F•	513	SWDSHOSE••	411
SLT10050	851, 1062	SSCF7••	420	ST•F••	513	SWDS-SS	394
SM300NYFDSS	841	SSCM74	420	STFC•	399	SW••F	767, 782, 821
SM515W50••	754	SSC-T••-1	1017	STFC••	399	SWG300-4	1062
SMB450	827	SSC-T••-2	1017	STFC•SS	399	SWMF•••	1044
SMB1525	827	SSCVIL••	913	STFP•	400	SWMF-RK•	1041
SM••F	808	SSE••	1066	STFP••	400	SWMF-RK••	1041, 1044
SM••F-D	808	SSGV••	900	STFP•B	400	SWNZ380•••	405
SM••F•F	808	SSGV•••	900	STFP•SS	400	SW-S400	831
SM•••FSS	841	SSLBV••	883	ST•F•-SS	513	S••X••X090CS	17, 172
SM••FSS	841	SSLBV•••	883	ST•F••-SS	513	S•••X••X120CS	17, 172
SM••F•T	808	SSLBV•••SP	883	ST•F•-V2	513	S••X••X120CS	17, 172
SM••F•T-D	808	SSLBV••SP	883	ST•F••-V2	513	SZW2	831
SM••NYFD	808	SSPM•	440	STMC•	399	SZW2-NL	831
SM••S	808	SST••	935	STMC••	399		
SM••S•F	808	SST•••	935	STMC•SS	399	T••	956, 965
SMV••	560, 904	SST10	278	STMP•	400	T•••	956, 965
S••N	371	ST•	358	STMP••	400	T2CM•••PL	651
SN••	560, 905	ST••	358	STMP•B	400	T2CM•••PM	651
SN•••	560, 905	ST•••	358	STMP•SS	400	T2CMP•••PL	651
SN75	413	ST8DC-A-V2	514	ST••OF••	513	T2CMP•••PM	651
SO••	956	ST16DC-A	514	ST•OF•	513	T2KM•••PL	652
SO•••	956	ST16F16-SS	513	ST•OF••	513	T2KM•••PM	652
SOE••	935	ST204B	472	ST•PF	363	T2KMP•••PL	652
SOE•••	935	ST205G	472	STR2•••	953	T2KMP•••PM	652
SOR••	956	ST206R	472	STR3•••	954	T2KS•••PL	652
SOT••	935	STB•	359	STR6648	954	T2KS•••PM	652
SOT•••	935	STB••	359	ST•SKIT	514	T2S88•••PL	652
SP••	386	STB•••	359	ST••SKIT	514	T2S88•••PM	652
SP•••	381, 386	STBC••	466	STV••	359	T2S92•••PL	652
SQF••	272	STBC•••	466	STV•••	359	T2S92•••PM	652
SRH360•••G••	722	STBC•••L	468	STV••CS	9, 11	T2S••PL	651
SRH360•••R••	722	STBC••L	468	STW••	767, 768	T2S•••PM	651
SS••	376, 419, 472	STB••CS	9	SUBV••	899	T3F3-SS	527
SS•••	837	ST••BF••	513	SUBV•••	899	T7IMPS•••••PL	657
SS337	157	ST•BF•	513	SUBVN100	899	T7IMPS•••••PM	657
SS2404-••	544	ST•BF••	513	SV••	275, 285, 911	T7IWMS•••••PL	657
SS2404-•••	544	ST•BF•-SS	513	SV•••	264, 275, 911	T7IWMS•••••PM	657
SS2405-••	544	ST•BF••-SS	513	SV••HD	275, 911	T7MP•••PL	654
SS2405-•••	544	ST•BF•-V2	513	SV••SS	275, 911	T7MP•••PM	654
SS2501-••	546	STC•	358	SV••SS	275, 911	T7MPS•••PL	656
SS2501-•••	546	STC••	358	SV••SS	275, 911	T7MPS•••PM	656
SSA••	395	STC•••	358	SW••	372, 831	T7RMP•••••PL	655
SSA•••	826	STC••••	360	SW•• 64, 372, 767, 768, 777,		T7RMP•••••PM	655
SSA30-550	826	STC•••••	360	782, 814, 821, 831		T7RMPS•••••PL	657
SSB••	472	STC-180•-R••	722	SW40-•••••	945		



Page #	Page #	Page #	Page #
T7RMPS.....PM ..... 657	TD•F•SS ..... 530	TMR.... 575, 576	TTC• ..... 942
T7RWWMS.....PL ..... 656	TD•PF••SS ..... 530	TN ..... 114	TTF4AL•FT ..... 118, 1031
T7RWWMS.....PM ..... 656	TES.... 1015	TN•• ..... 1004	TTF400SP ..... 118, 1031
T7RWWW.....PL ..... 653	TETF3X4• ..... 134	TN••• ..... 1004	TTF•AL ..... 118
T7RWWW.....PL ..... 653	TETF4AL ..... 119, 134, 1032	TN•••• ..... 1004	TTF•AL••EMT ..... 118, 1031
T7RWWW.....PM ..... 653	TETF4AL• ..... 134	TN-P ..... 114	TTF•AL••MT ..... 118, 1031
T7RWWW.....PM ..... 653	TETF4AL•/• ..... 134	TN-PLUG ..... 114	TTFS4AL-FP50 ..... 119, 1032
T7WWM•••PL ..... 654	TETF4AL•/•/• ..... 134	TN•••X• ..... 927	TTFS4SS ..... 123, 1026
T7WWM•••PM ..... 654	TETF4AL••• ..... 134	TN•••X•B ..... 451, 926	TTFST•CS ..... 10
T7WWM•••PL ..... 655	TETF4ALFP•• ..... 134	TN•••X•SS ..... 927	TTFST•CS-THK ..... 10
T7WWM•••PM ..... 655	TETF4ALFP50 ..... 119, 1032	TP•• ..... 575	TTMA-64 ..... 118
T7WWW•••PL ..... 653	TETFG4AL ..... 119, 134, 1032	TP•••• ..... 575, 576	TTMAHK-C ..... 137
T7WWW•••PM ..... 653	T•F• ..... 527	TP••• ..... 575	TTPM••••• ..... 1055
T14VB•••PL ..... 650	TF•• ..... 1005	TP••••• ..... 576	TTPM••••• ..... 1055
T16AMP•••••PL ..... 649	TFK ..... 252	TPF•• ..... 1010	TTPM••••• ..... 1055
T16AMP•••••PL ..... 649	TFN150••• ..... 788	TPG ..... 1064	TTPM••••• ..... 1055
T16AMP•••••PM ..... 649	TFN150NST••• ..... 788	TPL•• ..... 575	TUN0••G ..... 922
T16AMP•••••PM ..... 649	T•F•-PV ..... 527	TPL•••• ..... 575	TUN•F ..... 922
T16W•••PL ..... 649	TFS•• ..... 1005	TPL••• ..... 575	TUN••FS ..... 922
T16W•••PM ..... 649	T•F•-SS-PV ..... 527	TPM• ..... 369, 1010	TUN••G ..... 922
T22MP•••••PL ..... 650	TFV•• ..... 274, 908	TPN•• ..... 1010	TUN••SS ..... 922
T22MP•••••PL ..... 650	TFV2 ..... 908	TPP140 ..... 409	TVPC200-300 ..... 748
T31M•••••PL ..... 661	TFV2HB ..... 274, 908	TPR•• ..... 575	TVS7-30 ..... 412
T31M•••••PM ..... 661	TF••WF•-80 ..... 577	TPR•••• ..... 576	TVSEC-G•• ..... 747
T31W•••••PL ..... 661	TG•• ..... 575	TPS• ..... 942	T•W7 ..... 412, 1011
T31W•••••PM ..... 661	TG•••• ..... 575, 576	TPS•• ..... 942	TWGV25 ..... 1062
T32M•••••PL ..... 663	TG••• ..... 575	TPX• ..... 942	TYP2501 ..... 281
T32M•••••PM ..... 663	TG••••• ..... 576	TPX•• ..... 942	TYP2501• ..... 281
T32W•••••PL ..... 662	TGL•• ..... 575	TR ..... 114	TYP2501•• ..... 281
T32W•••••PM ..... 662	TGL•••• ..... 575, 576	TR••• ..... 956	
T600-60F ..... 957	TGL••• ..... 575	TR•BF• ..... 503	
T3114MP•••••PL ..... 662	TGR•• ..... 575	TR-C ..... 114	U•• ..... 990, 991
T3114MP•••••PM ..... 662	THB•• ..... 939, 1005	TR-CAP ..... 114	UHG250F ..... 858
T3214MP•••••PL ..... 663	THN•• ..... 366, 1004	TR•F• ..... 503	UHG250F-D ..... 858
T3214MP•••••PM ..... 663	TL14AM7•••PL ..... 601, 651	TRW7 ..... 1011	UHG250-W ..... 858
TA•• ..... 939, 1008, 1009	TL14AM7•••PM ..... 601, 651	TSA•• ..... 939	UPP250F ..... 777, 783
TA•••F ..... 1009	TLD•••S ..... 138	TSE•• ..... 941	UPP250F-SPEC ..... 783
TBC•• ..... 466	TLFS•• ..... 1006	TSS•• ..... 389	UPPT ..... 783
TC97 ..... 1003	TLS•• ..... 1006, 1009	TSSS•• ..... 1007	UPPT•• ..... 783
TC97RB ..... 1003	TLSS•• ..... 1006	TSST•• ..... 1007	USBG ..... 187
TCF• ..... 942	TLT•• ..... 1009	TT4ASG-ETH ..... 1026	USW ..... 828
TCF•• ..... 1005, 1008	TLTD•••S ..... 138	TT4ASG-ETHOE ..... 1026	
TCM•• ..... 1008	TLV•••TFVBVIAL ..... 138	TT•50 ..... 1055	V2DC ..... 500
TCMR-T•• ..... 1017	TM• ..... 369, 1007	TT•75 ..... 1055	VB-050••• ..... 138
TCN•• ..... 940	TM•• ..... 369, 575, 1007	TTA50LP ..... 1055	V•BF•• ..... 496
TCR-T•••• ..... 1017	TM•••• ..... 576	TTA50SS ..... 1055	V•BF• ..... 496
TCS••••F ..... 840	TM•• ..... 575	TT•ASG ..... 123, 1026	V•BF••-B ..... 496
TCS••••F•• ..... 840	TM••••• ..... 576	TT•ASG-ETH ..... 123, 1026	V•BF•-B ..... 496
TCT•• ..... 125	TML•• ..... 575	TT•ASG-ETHOE ..... 123	V•BF••-B-E ..... 499
T•DC ..... 528	TML•••• ..... 576	TT•ASGOE ..... 123, 1026	V•BF•-B-E ..... 499
TD••DC-A ..... 530	TML••• ..... 575	TTB100 ..... 1055	V•BF••-E ..... 499
TD•DC-A ..... 530	TMR•• ..... 575	TTBP50 ..... 1055	



# Part Number Index

	Page #		Page #		Page #		Page #
V•BF•E	499	VR4030CS-AL	120, 1033	W•DC	521	WS•BF•SS	523
V••BF••SS	496	VR4030CS-SH	120, 121, 1034	WDGV250NYFD	856	WSB••T	1013
V•BF•SS	496			WDGV3025F	857	WSB••T•••	1013
V••BF••SS-E	499	VR4040CS-4MNPT	121, 1034	WDGV••F	856, 857	WS•DC-A	525
V•BF•SS-E	499			WDH•BK50RAS	763	WS•DC-A	525
V•BRKIT	502	VR4040CS-AL	120, 1033	WDH•BK50RAT	763	WS•F••	523
V••DC-A	500	VR4040CS-ALS45	121, 1034	WDH•BK50UC	765	WS•F•	523
V•DC-A	500	VR4040CSRK•	120, 121, 1033, 1034	WDH•BK100RAF	763	WS•F••BOP	526
VEP8F8-SS	516			WDH•BK100RAS	763	WS•F•BOP	526
VEP••BF••	517	VR4050AL	1035	WDH•BK100RAT	763	WS•FH••	524
VEP•BF•	517	VR4050PL	1035	WDH•BK100UC	765	WS•FH•	524
VEP••DC-A	517	VR4086	1028	WDH•BK•GAX	764	WS•FP••	524
VEP•DC-A	517	VR4086-BY	1028	WDH•BK•KAF	764	WS•FP•	524
VEP••F••	517	VR6200	1022	WDH•BK•KAS	764	WS•F••SS	523
VEP•F•	517	VR6200NP	1022	WDH•BK•RAF	763	WS•F•SS	523
VEP••F••BOP	519	VRC3000AL	120, 1033	WDS0-SS	394	WS•F••SS-BOP	526
VEP•F•BOP	519	VR•••CS-AL	121, 1034	WDS1	393	WS•F•SS-BOP	526
VEP••FH••	518	VR•••CS-AL45	121, 1034	WDS1-SS	394	WS•OF••	523
VEP•FH•	518	VRHK	121, 1034	WDSR	393	WS•OF•	523
VEP••FP••	518	VRHK-C	121, 1034	W•F•	521	WSR•	261, 1099
VEP•FP•	518	V•RKIT	502	WF•	157	WSR1•	261
VEP••OF••	517	V•SSRKIT	502	WF••	157	WSR•SS	261
VEP•OF•	517	VT	112	WF•••	157	WSS••	462
V•F••	496	VT7	112	WF26-1	157	WTB-T••	1016
V•F•	496	VT9	112	W•F••B	521	WTB-T•Z	1016
V••F••B	496	VTT	112	W•F•B	521		
V•F•B	496	VTX	112	WH50X6AKBS50	1101	X02-04	311
V••F••B-E	499	VTX-9	112	WH50X6AKBS87	1101	X02-04MB	311
V•F•B-E	499			WH75X6AK35	265, 1101	X03-02	297
V••F••E	499	W•	158	WH300•	72	X03-02MB	297
V•F•E	499	W••	158	WH400•	72	X27	478
V••F••SS	496	WA•	261, 1099	WH•X•AKBS•	265	XK3F3	511
V•F•SS	496	WA2B	261	WHYD•••F	861	XLS••A0120P	894
V••F••SS-E	499	WA4FL12X••••	171	WM•	158	XPO•4F	894
V•F•SS-E	499	WA4FL12X•••••	171	WM••	158	XSO-4•••0A	894
V•JM••	495	WA•SS	261	WN••	952		
V•JM•	495	WB•	261, 1099	WN•••	957	Y•••	970
V•M••	495	WB1C	261	WN1000	957	Y10075	267
V•M•	495	WBC	158	WOC-T••	1016		
V••M••B	495	W•BF••B	521	WP2H••••	845		
V•M•B	495	W•BF•B	521	WP2H•••	845		
V•M•B-E	498	W•BMF	521	WP2H-ASSP••	845		
V••M••E	498	W••BMF	521	WP3H•••	845		
V•M•E	498	WBN•••	262	W•RKIT-V2	522		
V••M••SS	495	WB•SS	261	W••RKIT-V2	522		
V•M•SS	495	WD•01ALV	902, 1052	WSB••	1013		
V••M••SS-E	498	WD•01ALVB	902, 1052	WSB•••••	1013		
V•M•SS-E	498	WD•06ALV	902, 1052	WSB••••••	1013		
VN••••200	966	WD•06ALVB	902, 1052	WSB-20Z	1013		
VNR••••200	966	WD40	1063	WS•BF••	523		
V•OF••	496	W•DC	521	WS•BF•	523		
V•OF•	496			WS•BF••SS	523		

## Limited Warranty

DIXON VALVE AND COUPLING COMPANY, LLC (herein called "Dixon") warrants the products described herein and manufactured by Dixon to be free from defects in material and workmanship for a period of one (1) year from date of shipment by Dixon under normal use and service. Its sole obligation under this warranty being limited to repairing or replacing, as hereinafter provided, at its option any product found to Dixon's satisfaction to be defective upon examination by it, provided that such product shall be returned for inspection to Dixon's factory within three (3) months after discovery of the defect. The repair or replacement of defective products will be made without charge for parts or labor. This warranty shall not apply to: (a) parts or products not manufactured by Dixon, the warranty of such items being limited to the actual warranty extended to Dixon by its supplier; (b) any product that has been subject to abuse, negligence, accident, or misapplication; (c) any product altered or repaired by others than Dixon; and (d) to normal maintenance services and the replacement of service items (such as washers, gaskets, and lubricants) made in connection with such services. To the extent permitted by law, this limited warranty shall extend only to the buyer and any other person reasonably expected to use or consume the goods who is injured in person by any breach of the warranty. No action may be brought against Dixon for an alleged breach of warranty unless such action is instituted within one (1) year from the date the cause of action accrues. This limited warranty shall be construed and enforced to the fullest extent allowable by applicable law.

Other than the obligation of Dixon set forth herein, Dixon disclaims all warranties, express or implied, including but not limited to any implied warranties of merchantability or fitness for a particular purpose, and any other obligation or liability. The foregoing constitutes Dixon's sole obligation with respect to damages, whether direct, incidental, or consequential, resulting from the use or performance of the product.

Some products and sizes may be discontinued when stock is depleted or may require a minimum quantity for ordering.

---

## About This Catalog and Our Products

This catalog is intended as a product offering. It is not a user or technical manual. Information in this catalog is subject to change without notice. We may modify product design and specification without notice and without any obligation to modify or substitute products previously purchased. All users and distributors of products sold through this catalog are strongly encouraged to contact Dixon with questions on use, compatibilities, coupling procedures, and life of product. Our full-time engineering and test staff are always available to recommend uses and to assist distributors and users with questions.



---

### Safety



Safety logos, which appear throughout our catalog, are used as a reminder that the user should carefully review for the appropriateness of the product for the media, application, and environment in which it will be used.

NOTE: Because of the health hazards associated with contamination and lead content in drinking water systems, Dixon couplings, unless otherwise specifically approved, are not recommended for potable water service and should not be used in applications where drinking water will contact the wetted surfaces of the coupling.

All Dixon products are shipped in cartons with the following warning:

**"WARNING:** This product contains lead, a chemical known to the State of California to cause cancer and birth defects or other reproductive harm."

---

## Trademarks

Delrin® and Zytel® are registered trademarks of E.I. duPont Nemours and Company.

Kalrez® is a registered trademark of DuPont Dow Elastomers.

All other trademarks appearing in the Dixon illustrated price list are the property of their respective owners.

---

## Copyright

Copyright © 2021 by Dixon Valve and Coupling, LLC

All rights reserved. This book is copyrighted material. Use, reproduction or copying of it by anyone other than Dixon® is strictly forbidden without its express written consent.

NOTE: Reasonable care has been taken in preparing this catalog. Dixon Valve & Coupling Company, LLC reserves the right to make corrections.



